

SIEMENS

SIMATIC HMI

HMI devices Comfort Panels

Operating Instructions

www.nicsanat.com

021-87700210



Preface

Overview

1

Safety instructions

2

Mounting and connecting the device

3

Commissioning the device

4

Commissioning a project

5

Operating a project

6

Maintenance and care

7

Technical information

8

Technical Support

A

Markings and symbols

B

Abbreviations

C

Legal information

Warning notice system

This manual contains notices you have to observe in order to ensure your personal safety, as well as to prevent damage to property. The notices referring to your personal safety are highlighted in the manual by a safety alert symbol, notices referring only to property damage have no safety alert symbol. These notices shown below are graded according to the degree of danger.

DANGER

indicates that death or severe personal injury **will** result if proper precautions are not taken.

WARNING

indicates that death or severe personal injury **may** result if proper precautions are not taken.

CAUTION

indicates that minor personal injury can result if proper precautions are not taken.

NOTICE

indicates that property damage can result if proper precautions are not taken.

If more than one degree of danger is present, the warning notice representing the highest degree of danger will be used. A notice warning of injury to persons with a safety alert symbol may also include a warning relating to property damage.

Qualified Personnel

The product/system described in this documentation may be operated only by **personnel qualified** for the specific task in accordance with the relevant documentation, in particular its warning notices and safety instructions. Qualified personnel are those who, based on their training and experience, are capable of identifying risks and avoiding potential hazards when working with these products/systems.

Proper use of Siemens products

Note the following:

WARNING

Siemens products may only be used for the applications described in the catalog and in the relevant technical documentation. If products and components from other manufacturers are used, these must be recommended or approved by Siemens. Proper transport, storage, installation, assembly, commissioning, operation and maintenance are required to ensure that the products operate safely and without any problems. The permissible ambient conditions must be complied with. The information in the relevant documentation must be observed.

Trademarks

All names identified by ® are registered trademarks of Siemens AG. The remaining trademarks in this publication may be trademarks whose use by third parties for their own purposes could violate the rights of the owner.

Disclaimer of Liability

We have reviewed the contents of this publication to ensure consistency with the hardware and software described. Since variance cannot be precluded entirely, we cannot guarantee full consistency. However, the information in this publication is reviewed regularly and any necessary corrections are included in subsequent editions.

www.nicsanat.com

021-87700210



Preface

Purpose of the operating instructions

These operating instructions contain information based on the requirements for mechanical engineering documentation. This information relates to the place of use, transport, storage, mounting, use and maintenance.

These operating instructions are intended for:

- Users
- Commissioning engineers
- Maintenance personnel

Read especially the information in the chapter "Safety instructions" (Page 27).

You can find more information such as operating instructions, examples and reference information in the TIA Portal information system.

Basic knowledge required

General knowledge of automation technology and process communication is needed to understand the operating instructions. Knowledge of personal computers and the Microsoft operating systems is required to understand this manual.

Scope of the operating instructions

The operating instructions apply to the following HMI devices in conjunction with the WinCC software package:

Name	Type	Article number
SIMATIC HMI KP400 Comfort	4" Key Panel	6AV2124-1DC01-0AX0
SIMATIC HMI KTP400 Comfort	4" Touch/Key Panel	6AV2124-2DC01-0AX0
SIMATIC HMI KP700 Comfort	7" Key device	6AV2124-1GC01-0AX0
SIMATIC HMI TP700 Comfort	7" Touch Panel	6AV2124-0GC01-0AX0
SIMATIC HMI KP900 Comfort	9" Key Panel	6AV2124-1JC01-0AX0
SIMATIC HMI TP900 Comfort	9" Touch Panel	6AV2124-0JC01-0AX0
SIMATIC HMI KP1200 Comfort	12" Key Panel	6AV2124-1MC01-0AX0
SIMATIC HMI TP1200 Comfort	12" Touch Panel	6AV2124-0MC01-0AX0
SIMATIC HMI KP1500 Comfort	15" Key Panel	6AV2124-1QC02-0AX0, 6AV2124-1QC02-0AX1
SIMATIC HMI TP1500 Comfort	15" Touch Panel	6AV2124-0QC02-0AX0, 6AV2124-0QC02-0AX1
SIMATIC HMI TP1900 Comfort	19" Touch Panel	6AV2124-0UC02-0AX0, 6AV2124-0UC02-0AX1
SIMATIC HMI TP2200 Comfort	22" Touch Panel	6AV2124-0XC02-0AX0, 6AV2124-0XC02-0AX1

NOTICE
Manual is part of the HMI device
This manual is part of the HMI device and is also required for repeat commissioning. Keep all supplied and supplementary documentation for the entire service life of the HMI device.
Provide all stored documents to subsequent owners of the HMI device.

Trademarks

The following designations marked with the symbol ® are registered trademarks of Siemens AG:

- HMI®
- SIMATIC®
- WinCC®

Style conventions

Text description	Example	Meaning
Text in quotation marks: "Text"	"Add screen"	<ul style="list-style-type: none"> • Terminology that appears in the user interface, for example dialog names, tabs, buttons, menu commands • Required input, for example, limits, tag values. • Path information
Text in quotation marks, separated by a 'greater than' symbol: "Text > Text"	"File > Edit"	Operating sequences, for example, menu commands, shortcut menu commands.
Texts in angle brackets: <Text>	<F1>, <Alt+P>	Keyboard operation
	<ip>, <date>, <time>	Variable values in URLs, path information, folder names, file names or in the user interface

Please observe notes labeled as follows:

Note

A note contains important information about the product described in the manual and its use, or a specific section of the manual to which you should pay particular attention.

Naming conventions

Term	Applies to	
System	<ul style="list-style-type: none"> System Machining center One or more machines 	
Comfort HMI device HMI device Device	<ul style="list-style-type: none"> KP400 Comfort KTP400 Comfort KP700 Comfort TP700 Comfort KP900 Comfort TP900 Comfort KP1200 Comfort TP1200 Comfort 	<ul style="list-style-type: none"> KP1500 Comfort TP1500 Comfort TP1900 Comfort TP2200 Comfort
Key model Key HMI device	<ul style="list-style-type: none"> KP400 Comfort KP700 Comfort KP900 Comfort KP1200 Comfort 	<ul style="list-style-type: none"> KP1500 Comfort
Touch model Touch HMI device	<ul style="list-style-type: none"> KTP400 Comfort TP700 Comfort TP900 Comfort TP1200 Comfort 	<ul style="list-style-type: none"> TP1500 Comfort TP1900 Comfort TP2200 Comfort
Comfort V1 devices	<ul style="list-style-type: none"> KP400 Comfort KTP400 Comfort KP700 Comfort, F-State <19² TP700 Comfort, F-State <22² KP900 Comfort, F-State <18² TP900 Comfort, F-State <19² KP1200 Comfort, F-State <20² TP1200 Comfort, F-State <20² 	<ul style="list-style-type: none"> KP1500 Comfort, MLFB 6AV2124-1QC02-0AX0 TP1500 Comfort, MLFB 6AV2124-0QC02-0AX0 TP1900 Comfort, MLFB 6AV2124-0UC02-0AX0 TP2200 Comfort, MLFB 6AV2124-0XC02-0AX0
Comfort V1.1 devices	<ul style="list-style-type: none"> KP700 Comfort, F-State ≥19² TP700 Comfort, F-State ≥22² KP900 Comfort, F-State ≥18² TP900 Comfort, F-State ≥19² KP1200 Comfort, F-State ≥20² TP1200 Comfort, F-State ≥20² 	

Term	Applies to		
Comfort V2 devices		<ul style="list-style-type: none"> • KP1500 Comfort, MLFB 6AV2124-1QC02-0AX1 • TP1500 Comfort, MLFB 6AV2124-0QC02-0AX1 • TP1900 Comfort, MLFB 6AV2124-0UC02-0AX1 • TP2200 Comfort, MLFB 6AV2124-0XC02-0AX1 	
WinCC ¹	WinCC V11 (TIA Portal) or higher for configuring devices of 12" and smaller	WinCC V11 SP2 HSP Comfort (TIA Portal) or higher for configuring Comfort V1 devices as of 15"	WinCC V14 SP1 HSP 0211 HMI TP1500 - TP2200 Comfort (TIA Portal) or higher for configuring Comfort V2 devices as of 15"

¹ Devices are configurable as of WinCC V11. The description in this manual relates to V14 or higher.

² You can find the F-State (functional status) on the rating plate of the HMI device.

Features of the various device versions:

- Comfort V1: Display sizes 4"...22", with audio double socket and USB socket type Mini-B, Windows CE 6 operating system
- Comfort V1.1: Display sizes 7"...12", with audio OUT and USB socket type Mini-B, Windows CE 6 operating system
- Comfort V2: Display sizes 15"...22", with audio OUT without USB socket type Mini-B, Windows Embedded Compact 2013 operating system

Figures

This manual contains figures of the described devices. The figures can deviate from the particularities of the delivered device.

Picture components are marked with black position numbers on a white background ①, ②, ③, etc.

Steps in the figures are identified with white process numbers on a black background according to the sequence in which they have to be executed: ❶, ❷, ❸, ...

Table of contents

	Preface	3
1	Overview.....	13
1.1	Product description.....	13
1.2	Scope of delivery	15
1.3	Design of the devices.....	16
1.3.1	KP400 Comfort and KTP400 Comfort.....	16
1.3.2	KP700 Comfort to KP1500 Comfort, TP700 Comfort to TP2200 Comfort	18
1.3.3	Interfaces	20
1.4	Accessories.....	22
1.5	The HMI device in the operating process	24
1.6	Software add-ons.....	25
2	Safety instructions.....	27
2.1	General safety instructions.....	27
2.2	Security management for HMI devices	29
2.3	Data protection.....	29
2.4	Notes about usage.....	29
2.5	Use in hazardous areas	31
3	Mounting and connecting the device	33
3.1	Preparing for installation.....	33
3.1.1	Selecting installation location	33
3.1.2	Checking the delivery.....	33
3.1.3	Checking the operating conditions	34
3.1.4	Permitted mounting positions	34
3.1.5	Checking clearances	36
3.1.6	Preparing the mounting cutout	37
3.1.7	Labeling the function keys	38
3.2	Mounting the device.....	41
3.3	Connecting the device	45
3.3.1	Notes on connection.....	45
3.3.2	Equipotential bonding	47
3.3.3	Connecting the power supply.....	49
3.3.4	Connecting the configuration PC.....	51
3.3.5	Connecting the controller	53
3.3.6	Connecting a USB device.....	55
3.3.7	Connecting a printer	56
3.3.8	Connecting an audio device	57
3.3.9	Switching on and testing the device.....	57
3.3.10	Securing the cables.....	59
3.3.11	Securing cables for use in hazardous areas	60
3.4	Removing the device.....	61

4	Commissioning the device	63
4.1	Overview	63
4.1.1	Firmware and software	63
4.1.2	Memory concept.....	63
4.1.3	Changing the memory cards	67
4.1.4	Front operator controls	69
4.2	Operating the device	71
4.2.1	Reference for system keys.....	71
4.2.2	Entering values with system keys	75
4.3	Parameterizing the Comfort Panel	76
4.3.1	Desktop and Start Center	76
4.3.2	Installed programs	77
4.3.3	Security mode	78
4.3.3.1	Overview.....	78
4.3.3.2	Operating the HMI device in password-protected safety mode.....	79
4.3.4	Control Panel.....	80
4.3.4.1	Opening the settings	80
4.3.4.2	Overview of functions.....	80
4.3.4.3	Operating the Control Panel.....	82
4.3.4.4	Display types for the screen keyboard	82
4.3.5	Configuring operation.....	85
4.3.5.1	Changing display brightness	85
4.3.5.2	Change screen orientation	86
4.3.5.3	Configuring the screen keyboard	87
4.3.5.4	Setting the character repeat rate of the screen keyboard	89
4.3.5.5	Setting the double-click	90
4.3.5.6	Calibrating the touch screen	91
4.3.5.7	Restarting the HMI device	92
4.3.6	General settings.....	94
4.3.6.1	Regional and language settings.....	94
4.3.6.2	Setting the date and time	94
4.3.6.3	Changing the password protection.....	96
4.3.6.4	Setting the screen saver.....	97
4.3.6.5	Parameterizing Transfer	99
4.3.6.6	Memory management	102
4.3.6.7	Backing up registry information and temporary data	106
4.3.6.8	Changing the print options	107
4.3.6.9	Displaying general system properties	108
4.3.6.10	Displaying information about the Comfort Panel	109
4.3.6.11	Setting volume and sound	110
4.3.7	Changing Internet settings.....	113
4.3.7.1	Changing general settings	113
4.3.7.2	Setting the proxy server	114
4.3.7.3	Changing Internet security settings.....	115
4.3.7.4	Activating encryption protocols.....	116
4.3.7.5	Importing, displaying and deleting certificates	117
4.3.8	Enabling PROFINET	119
4.3.9	Enabling NTP	121

4.3.10	Configuring network operation	122
4.3.10.1	Overview	122
4.3.10.2	Specifying the computer name of the HMI device	124
4.3.10.3	Entering the IP address and name server	125
4.3.10.4	Changing MPI/PROFIBUS DP settings.....	128
4.3.10.5	Specifying the logon data	129
4.3.10.6	Configuring e-mail	130
4.3.10.7	Configuring Telnet for remote control	131
4.3.10.8	Configure Sm@rt Server.....	133
4.3.10.9	Configure Web Server	134
4.3.11	Functions for service and commissioning	137
4.3.11.1	Saving to external storage medium – backup	137
4.3.11.2	Restoring from external storage medium – Restore	139
4.3.11.3	Updating the operating system	141
4.3.11.4	Load project from external storage medium	144
4.3.11.5	Using automatic backup.....	148
4.3.11.6	Editing IP addresses and communication connections	152
4.3.12	Uninterruptible power supply.....	158
4.3.12.1	Setting the uninterruptible power supply	158
4.3.12.2	State of the uninterruptible power supply	160
5	Commissioning a project	161
5.1	Overview	161
5.2	Operating modes.....	162
5.3	Using existing projects	163
5.4	Data transmission options.....	163
5.5	Transferring a project with WinCC	164
5.5.1	Configuring data channel and setting transfer mode	164
5.5.2	Starting the transfer.....	164
5.5.3	Testing a project	166
5.6	Backup and restore	167
5.6.1	Overview	167
5.6.2	Backing up and restoring data of the HMI device	168
5.7	Updating the operating system	169
5.7.1	Updating the operating system	169
5.7.2	Updating the operating system of the HMI device.....	169
5.8	Managing add-ons and license keys	172
5.8.1	Managing add-ons.....	172
5.8.2	Transferring license keys.....	173
5.8.3	Managing license keys	173
6	Operating a project.....	175
6.1	Overview	175
6.2	Function keys	178
6.3	Direct keys.....	178
6.4	Setting the project language	179
6.5	Input of values.....	180

6.6	Entering and editing numerical values.....	181
6.7	Entering or changing alphanumeric values.....	182
6.8	Displaying infotext.....	183
6.9	Closing the project.....	184
7	Maintenance and care	185
7.1	General information on maintenance and servicing.....	185
7.2	Cleaning the device front.....	185
7.2.1	Clean the touch screen and keyboard cover.....	185
7.2.2	Clean screen for Touch HMI devices	186
7.3	Spare parts and repairs	187
7.4	Recycling and disposal	187
8	Technical information	189
8.1	Software license agreements	189
8.2	Certificates and approvals	189
8.3	Electromagnetic compatibility.....	195
8.4	Mechanical ambient conditions.....	197
8.4.1	Storage conditions.....	197
8.4.2	Operating conditions	197
8.5	Climatic ambient conditions.....	197
8.5.1	Long-term storage	197
8.5.2	Transport and short-term storage.....	198
8.5.3	Operating conditions	198
8.5.4	Climate diagram	199
8.6	Information on insulation tests, protection class and degree of protection.....	200
8.7	Dimension drawings	201
8.7.1	Dimension drawings of the KP400 Comfort	201
8.7.2	Dimension drawings of the KP700 Comfort	202
8.7.3	Dimension drawings of the KP900 Comfort	203
8.7.4	Dimension drawings of the KP1200 Comfort	204
8.7.5	Dimension drawings of the KP1500 Comfort V1	205
8.7.6	Dimension drawings of the KP1500 Comfort V2	206
8.7.7	Dimension drawings of the KTP400 Comfort	207
8.7.8	Dimension drawings of the TP700 Comfort	208
8.7.9	Dimension drawings of the TP900 Comfort	209
8.7.10	Dimension drawings of the TP1200 Comfort	210
8.7.11	Dimension drawings of the TP1500 Comfort V1	211
8.7.12	Dimension drawings of the TP1500 Comfort V2	212
8.7.13	Dimension drawings of the TP1900 Comfort V1	213
8.7.14	Dimension drawings of the TP1900 Comfort V2	214
8.7.15	Dimension drawings of the TP2200 Comfort V1	215
8.7.16	Dimension drawings of the TP2200 Comfort V2	216
8.7.17	Dimensions for labeling strips	217
8.8	Technical specifications	219
8.8.1	KP400 Comfort to KP1200 Comfort, KTP400 Comfort to TP1200 Comfort	219
8.8.2	KP1500 Comfort, TP1500 Comfort to TP2200 Comfort	221

8.9	Bit assignment of the direct keys	224
8.9.1	KTP400 Comfort	224
8.9.2	KP400 Comfort	224
8.9.3	KP700 Comfort	225
8.9.4	TP700 Comfort	225
8.9.5	KP900 Comfort	226
8.9.6	TP900 Comfort	226
8.9.7	KP1200 Comfort	227
8.9.8	TP1200 Comfort	227
8.9.9	KP1500 Comfort	228
8.9.10	TP1500, TP1900 and TP2200 Comfort.....	228
8.10	Description of the interfaces	229
8.10.1	DC24V X80	229
8.10.2	PROFIBUS DP X2.....	229
8.10.3	PROFINET (LAN) X1	230
8.10.4	PROFINET (LAN) X3	230
8.10.5	USB X61/X62	231
8.10.6	USB X60 of the Comfort V1/V1.1 devices.....	231
8.10.7	Audio X90	231
8.11	Communication with controllers	232
8.12	Scope of functions with WinCC.....	235
A	Technical Support	239
A.1	Service and support	239
A.2	Troubleshooting	240
A.3	Application examples and FAQs	240
A.4	System alarms	241
A.5	Information about the manufacturer.....	241
B	Markings and symbols	243
B.1	Safety-relevant symbols	243
C	Abbreviations	245
	Glossary	247

Overview

1.1 Product description

SIMATIC HMI Comfort Panels are a fully redesigned product line of the Touch Panels and Key Panels. The product line includes the following models:

- Five key panels (operated by keyboard) with 4", 7", 9", 12" and 15" displays
- Six touch panels (operated by touch screen) with 7", 9", 12", 15", 19" and 22" displays.
- One Key&Touch Panel (operated by keyboard and touch screen) with 4" display size

All devices offer the same excellent functionality and are configured exclusively with the innovative HMI software, WinCC. The software is integrated into the engineering framework, "Totally Integrated Automation Portal".

Features of the SIMATIC HMI Comfort Panels

Enclosure	Plastic enclosure for the 4" model Aluminum pressure enclosures for all 7" models and larger
Mounting format	Mounting and operation of the touch models in landscape and portrait format The respective format must be selected during the configuration of the user interface. The display orientation must also be changed in the Start Center of the HMI device.
Interfaces	2 PROFINET interfaces (exception: KP400 Comfort and KTP400 Comfort have only 1 PROFINET interface) Additional gigabit PROFINET interface for devices of 15" or more 1 PROFIBUS interface USB 2.0 ports: <ul style="list-style-type: none"> • USB host interface (type A) <ul style="list-style-type: none"> – 1 x for 4" model – 2 x for 7", 9" and 12" models • USB device interface (type Mini B) <ul style="list-style-type: none"> – 1 x with Comfort V1/1.1 devices
Display	High-resolution TFT display in widescreen format with 16 million colors Wide viewing angle Completely dimmable
Operation	Text and numbers are entered using the keypad system familiar from cell phones for the key models. All freely configurable function keys have LEDs All keys have a clear pressure point for additional safety in the operation

1.1 Product description

Software	Internet Explorer to display web pages Viewer for PDF, Excel and Word documents Runtime software with logging and scripting functionality, system diagnostics for SIMATC controllers, display of trends (f(x), f(t)), etc.
Data storage	2 memory card slots <ul style="list-style-type: none">• One slot for storing user data• One slot for using the service concept for simplified restart in the event of service. Project data and device settings are updated automatically on the system card. No data inconsistency in the event of a power failure. Applies to the HMI device and inserted SIMATIC HMI memory cards ≥ 2 GB.
Controller	The system diagnostics of SIMATIC controllers can be read from the HMI device, which means no additional programming device is required.



Device variants for special requirements

The following device variants are available for use in areas with special requirements:

- Comfort PRO Panels, all-round IP65 and Type 4X/12 protected, for use directly at the machine or in harsh environmental conditions.
- Comfort Outdoor Panels for indoor and outdoor areas, e.g. oil & gas, marine or cooling systems.
- Comfort Panels INOX for areas with increased safety and hygiene requirements, e.g. food, beverages and tobacco industries, pharmaceutical industry or fine chemicals industry.

1.2 Scope of delivery

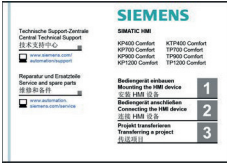
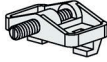
The scope of delivery of the HMI device includes the following components:

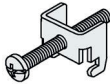
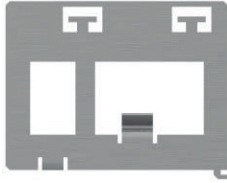
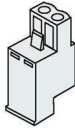
Name	Figure	Quantity	
HMI device		1	
Installation instructions (Quick Install Guide)		1	
Mounting clips with grub screw or cylinder head screw		6	KTP400 Comfort KP400 Comfort
		12	TP700 Comfort KP700 Comfort
		16	TP900 Comfort KP900 Comfort
		12	TP1500 Comfort KP1500 Comfort TP1900 Comfort TP2200 Comfort
Strain relief	Example: Strain relief KTP400/KP400 	1	KTP400 Comfort KP400 Comfort TP700 Comfort KP700 Comfort
Power supply connector		1	

1.3 Design of the devices

1.3.1 KP400 Comfort and KTP400 Comfort

The following sections describe the basic design of the KP400 Comfort and KTP400 Comfort HMI devices.

Front view

The figure below shows the front view of the HMI devices KP400 Comfort (left) and KTP400 Comfort (right):

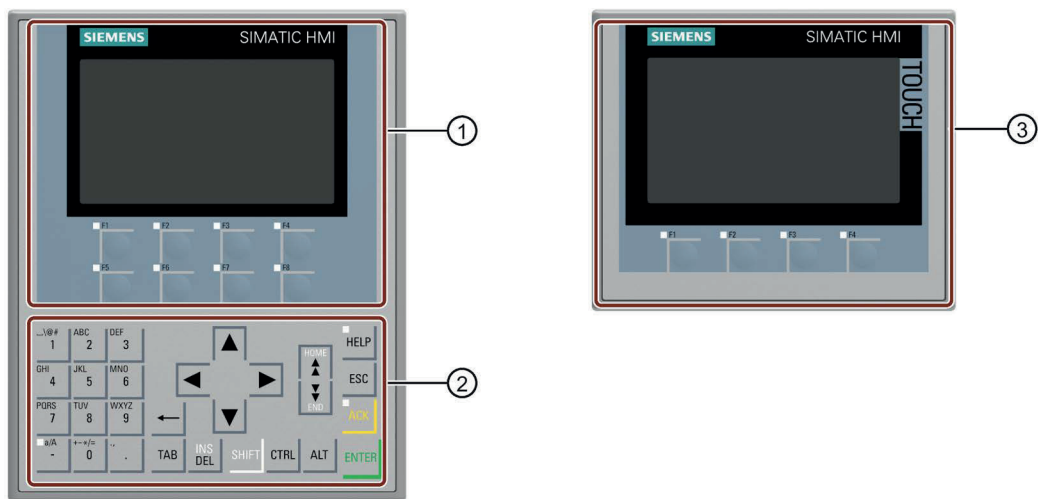

- ① Display with function keys
- ② Keyboard / system keys
- ③ Touch screen display with function keys

Rear view

The figure below shows the rear view of the HMI devices, KP400 Comfort (left) and KTP400 Comfort (right):

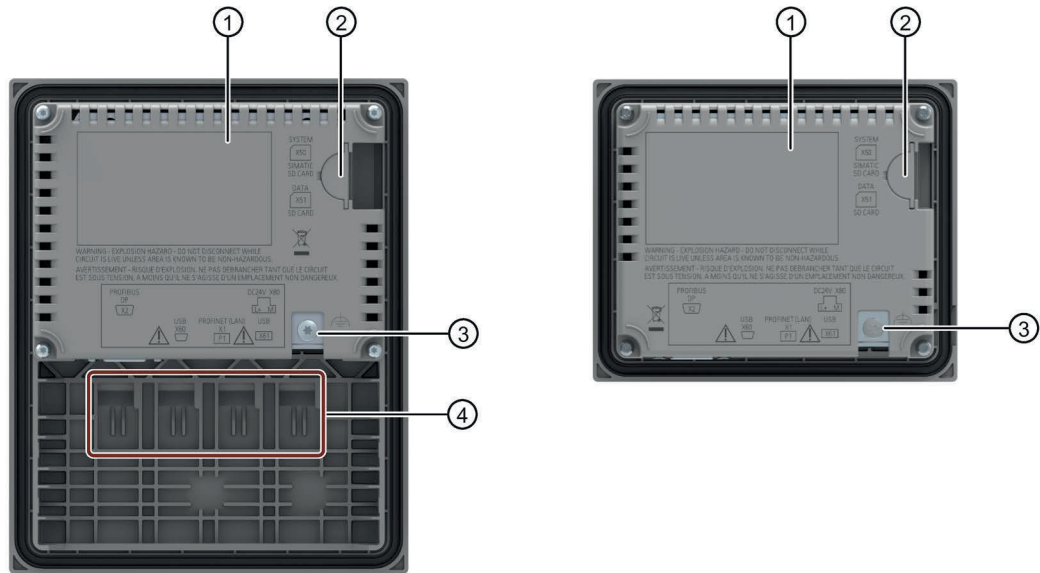

- ① Blank space for the nameplate
- ② Slots for SD memory cards - accessible from the device side
- ③ Connection for functional ground
- ④ Guides for labeling strips

Bottom view and side view

The figure below shows the bottom view and the side view of the KP400 HMI device:

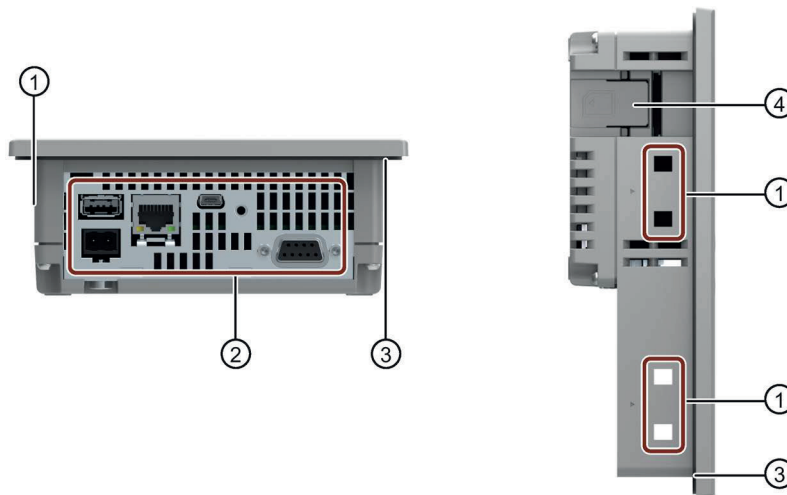

- ① Cutouts for mounting clips
- ② Interfaces
- ③ Mounting seal
- ④ Slots for SD memory cards

1.3.2 KP700 Comfort to KP1500 Comfort, TP700 Comfort to TP2200 Comfort

The following sections describe the basic design of the devices with 7" or larger displays, using the KP700 Comfort and TP700 Comfort as examples. The enclosure dimensions and form for the other models may differ from the illustrations shown.

Front view

The figure below shows the front view of the HMI devices, using the KP700 Comfort and TP700 Comfort as examples.

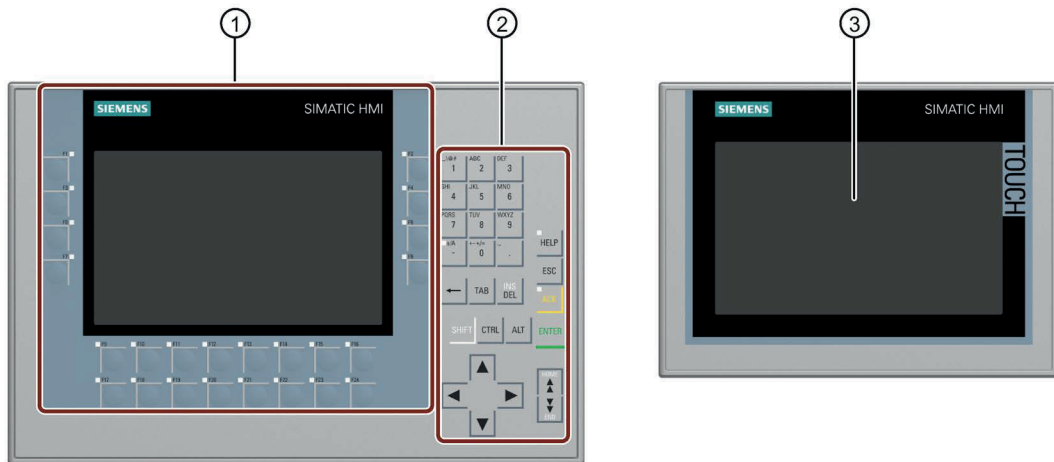

- ① Display with function keys
The number of function keys varies depending on display size
- ② Keyboard / system keys
- ③ Touch screen display

Rear view

Comfort V1/V1.1 devices

The figure below shows back views of Comfort V1/V1.1 devices with KP700 Comfort and TP700 Comfort as examples.

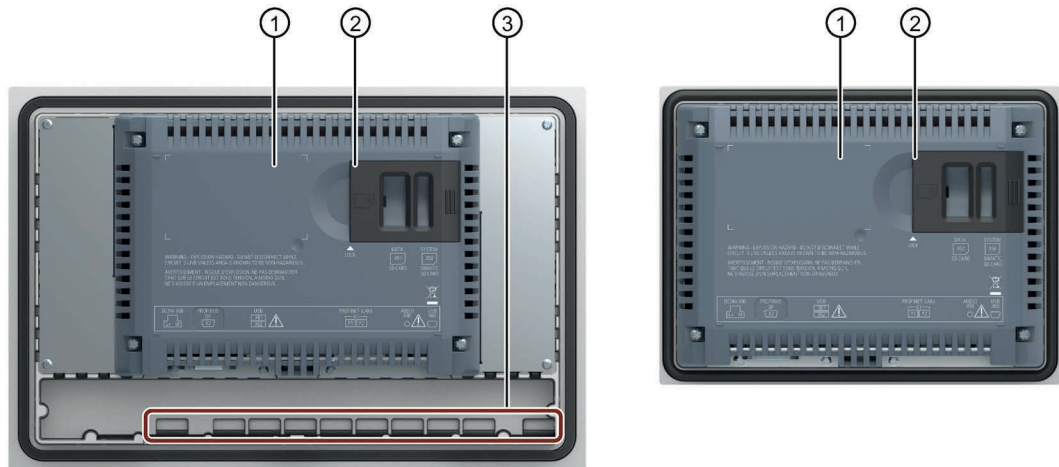

- ① Blank space for the nameplate
- ② Slots for SD memory cards
- ③ Guides for labeling strips

Comfort V2 devices

The figure below shows the back view of Comfort V2 devices with TP1500 Comfort as an example.

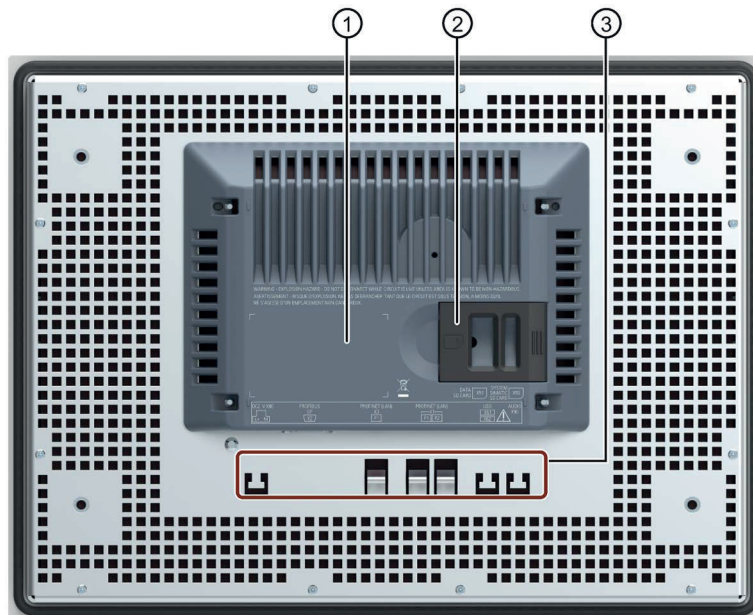

- ① Blank space for the nameplate
- ② Slots for SD memory cards
- ③ Fasteners for cable ties for strain relief

Side view

The figure below shows the side views of the HMI devices with the Comfort V1 devices, KP700 Comfort and TP700 Comfort, as examples.

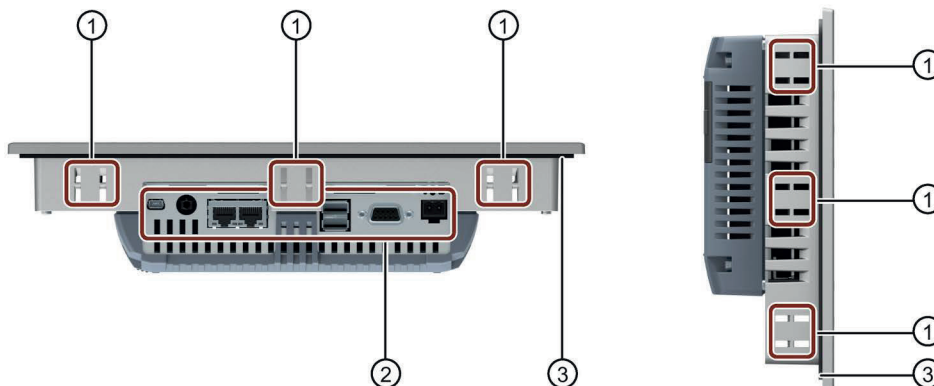

- ① Cutouts for mounting clips
- ② Interfaces
- ③ Mounting seal

1.3.3 Interfaces

Interfaces for the 4" models

The figure below shows the ports of the Comfort V1 devices, KP400 and KTP400 Comfort.

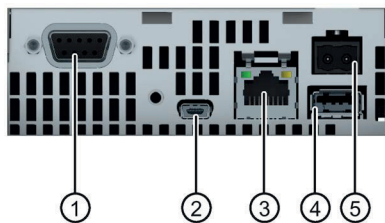

- ① X2 PROFIBUS (Sub-D RS422/485)
- ② X60 USB type Mini B
- ③ X1 PROFINET (LAN), 10/100 Mb
- ④ X61 USB type A
- ⑤ X80 power supply connector

Interfaces for the 7", 9" and 12" models

The figure below shows the interfaces for the following HMI devices:

- KP700 and TP700 Comfort
- KP900 and TP900 Comfort
- KP1200 and TP1200 Comfort

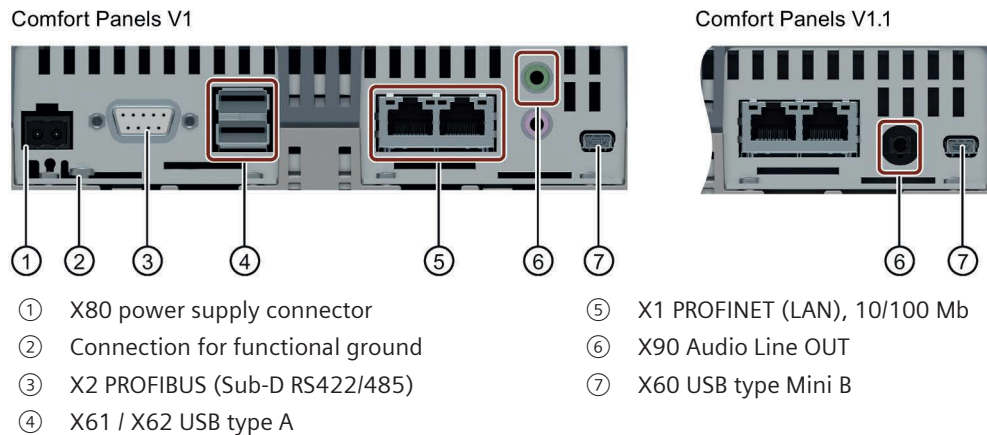

Interfaces for the 15", 19" and 22" models

The figure below shows the interfaces for the following HMI devices:

- KP1500 and TP1500 Comfort
- TP1900 Comfort
- TP2200 Comfort

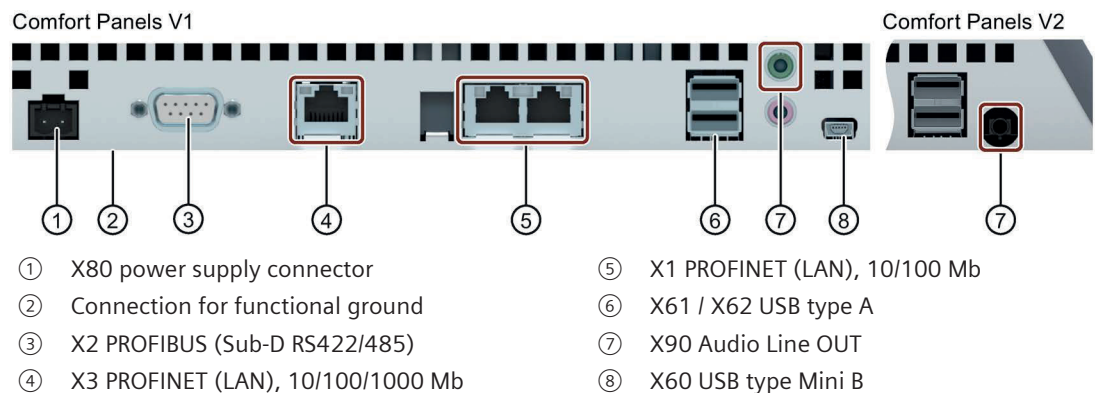

Additional information

Use the X1 or X60 interface to connect a configuration PC. Use the X61 / X62 interfaces to connect peripheral devices such as a printer or keyboard. Use the X90 interface to connect an audio device.

You can fasten the USB and PROFINET connecting cables to the rear panel of the HMI device with cable ties.

With the 4" and 7" models, protect the cables with a separate strain relief. Install the strain relief on the HMI device.

See also

Description of the interfaces (Page 229)

1.4 Accessories

An accessory kit with the necessary accessories is included with the HMI device.

Note

This section contains a selection of accessories that is suitable for your HMI device. You can find additional versions of this selection and the complete accessories portfolio in the Industry Mall on the Internet (<https://mall.industry.siemens.com/mall/en/WW/Catalog/Products/10144445>). Details such as the delivery quantity and technical specifications of accessories can be found in the Industry Mall under the respective article numbers.

You can find an overview of the status and compatibility of the accessories portfolio in the "Cross-list" on the Internet (<https://support.industry.siemens.com/cs/ww/en/view/40466415>).

HMI I/O components

Name	Article number
Converter RS 422 to RS 232 for connecting third-party controllers	6AV6671-8XE00-....
90° elbow adapter for RS422/RS485 interface	6AV6671-8XD00-....
Plug for the power supply of the HMI device, 2-pin, screw technology	6AV6671-8XA00-....
Plug for the power supply of the HMI device, 2x2-pin, spring-loaded terminal technology	6ES7193-4JB00-....

"...." stands for the variant key of the article number.

Protective films

Name	Article number
Protective film 4" widescreen for KTP400 Comfort	6AV2124-6DJ00-....
Protective film 7" widescreen for TP700 Comfort	6AV2124-6GJ00-....
Protective film 9" widescreen for TP900 Comfort	6AV2124-6JJ00-....
Protective film 12" widescreen for TP1200 Comfort	6AV2124-6MJ00-....
Protective film 15" widescreen for TP1500 Comfort	6AV2124-6QJ00-....
Protective film 19" widescreen for TP1900 Comfort	6AV2124-6UJ00-....
Protective film 22" widescreen for TP2200 Comfort	6AV2124-6XJ00-....

"...." stands for the variant key of the article number.

Storage media

Use only the following storage media for the HMI device.

Name	Article number
SIMATIC HMI Memory Card	6AV2181-8XP00-....
SIMATIC HMI USB stick	6AV6881-0AS42-....

"...." stands for the variant key of the article number.

Read the notes on using the memory media in the section "Memory concept (Page 63)".

Fasteners

Name	Article number
Set of plastic mounting clamps for KP400 Comfort and KTP400 Comfort	6AV6671-8XK00-....
Set of aluminum mounting clamps for TP700 Comfort, KP700 Comfort, TP900 Comfort, KP900 Comfort, TP1200 Comfort and KP1200 Comfort	6AV6671-8XK00-....
Set of steel mounting clamps for KP1500 Comfort, TP1500 Comfort, TP1900 Comfort and TP2200 Comfort	6AV6671-8XK00-....
Memory card lock protection for 4" Comfort Panels	6AV2181-4DM10-....
Memory card lock protection for 7" - 22" Comfort Panels	6AV2181-4XM00-....

"...." stands for the variant key of the article number.

Input help

Name	Article number
Touch pen system for resistive and capacitive touch systems	6AV2181-8AV20-...

"...." stands for the variant key of the article number.

Additional USB accessories

Additional USB accessories can be found on the Internet in the following entry:
FAQ 19188460 (<https://support.industry.siemens.com/cs/ww/en/view/19188460>)

Other accessories

You can find additional accessories for SIMATIC HMI devices on the Internet at the following link:

Accessories (<https://mall.industry.siemens.com/mall/en/WW/Catalog/Products/10144445>)

1.5 The HMI device in the operating process

The HMI device is part of the operating process. The following two phases are key to the way the HMI device is integrated in the process:

- Configuration
- Process management

Configuration

During the configuration phase, you create the user interfaces for operation and monitoring of the technical process to a configuration PC with WinCC as of version 11. Configuration also includes:

- Creating project data
- Saving project data
- Testing project data
- Simulating project data

After compiling the configuration, you download the project to the HMI device.

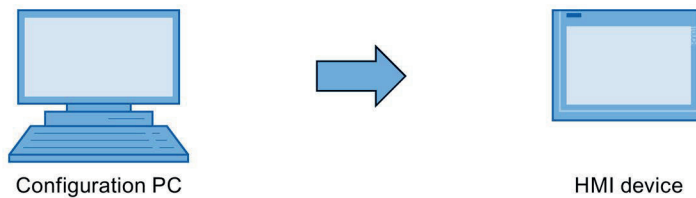

Process management

Process management is marked by two-way communication between HMI device and controller.

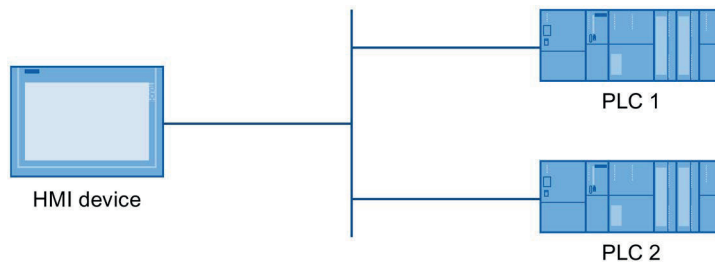

You then use the HMI device to operate and monitor the process.

1.6 Software add-ons

The following software add-ons are available for the HMI devices:

Add-on	Description
WinCC /Sm@rtServer ¹ <ul style="list-style-type: none"> Web Server 	The WinCC /Sm@rtServer add-on enables you to access a remote HMI device from the HMI device or PC via Ethernet. It also enables you to set up communication between different HMI systems. The WinCC /Sm@rtServer option also lets you use the Web Server on the HMI device.
WinCC /Audit ²	The WinCC /Audit add-on extends the HMI device to include functions for recording operations in an audit trail and electronic signature.
WinCC /ProDiag ⁵	Use the option WinCC /ProDiag to configure detailed plant and machine monitoring
Uninterruptable Power Supply (UPS) with USB support ⁴	When interfacing an uninterruptible power supply, the HMI device is shut down in a controlled manner after a buffer time in the event of a power failure. The HMI devices support SITOP DC UPS modules connected via the USB port.
PDF Viewer ³	You can view PDF documents using the PDF Viewer.
Word Viewer ³	The Word Viewer enables you to view Word documents.
Excel Viewer ³	The Excel Viewer enables you to view Excel documents.
Media Player ³	You can use the Media Player to play audio and video files.
Internet Explorer ³	The Internet Explorer provides you access to the Internet.
Printer driver ⁴	The printer driver option enables PostScript, HTML and PDF output for all HMI device print options.

- ¹ Transferred with the project; a license key is required for use up to WinCC V14 (TIA Portal), as of WinCC V14 (TIA Portal), a license key is no longer required
- ² Transferred with the project; a license key is required for use
- ³ Pre-installed; no license key is required for use
- ⁴ Must be transferred as an option; no license key is required for use
- ⁵ You can find information on licensing in the TIA information system

See also

Approved printers for SIMATIC HMI Panels

(<https://support.industry.siemens.com/cs/ww/en/view/11376409>)

Printing with SIMATIC Comfort HMI devices

(<https://support.industry.siemens.com/cs/ww/en/view/58205602>)

Safety instructions

2.1 General safety instructions

The device is designed for operation in industrial areas for operator control and monitoring of plant processes.

Observe the safety and accident prevention instructions applicable to your application in addition to the safety information given in the device documentation.

Open equipment

 WARNING
<p>The device constitutes open equipment on the back side</p> <p>The device constitutes open equipment on the back side. This means that the device may only be integrated in an enclosure or cabinet which provides front access for operating the device. The enclosure or the cabinet must provide protection against electric shock and the spread of fire. The enclosure or the cabinet must meet the requirements for mechanical strength and the degree of protection for the relevant application.</p> <p>Access to the enclosure or cabinet in which the device is installed should only be possible by means of a key or tool and only for qualified personnel.</p>

 WARNING
<p>Electrocution risk when control cabinet is open</p> <p>When you open the control cabinet, there may be a dangerous voltage at certain areas or components.</p> <p>Touching these areas or components can cause electrocution.</p> <p>Disconnect the cabinet from the mains before opening it. Do not plug in or pull out plant components during operation.</p>

Safety of the plant or the system

NOTICE
<p>Safety is the responsibility of the assembler</p> <p>The safety of any plant or system incorporating the equipment is the responsibility of the assembler of the plant or system.</p>

2.1 General safety instructions

ESD



An electrostatically sensitive device is equipped with electronic components. Due to their design, electronic components are sensitive to overvoltage and thus to the discharge of static electricity. Note the corresponding regulations when handling ESD.

Industrial Security

Siemens provides products and solutions with industrial security functions that support the secure operation of plants, systems, machines and networks.

In order to protect plants, systems, machines and networks against cyber threats, it is necessary to implement – and continuously maintain – a holistic, state-of-the-art industrial security concept. Siemens' products and solutions constitute one element of such a concept.

Customers are responsible for preventing unauthorized access to their plants, systems, machines and networks. Such systems, machines and components should only be connected to an enterprise network or the internet if and to the extent such a connection is necessary and only when appropriate security measures (e.g. firewalls and/or network segmentation) are in place.

For additional information on industrial security measures that may be implemented, please visit (<https://www.siemens.com/industrialsecurity>).

Siemens' products and solutions undergo continuous development to make them more secure. Siemens strongly recommends that product updates are applied as soon as they are available and that the latest product versions are used. Use of product versions that are no longer supported, and failure to apply latest updates may increase customer's exposure to cyber threats.

To stay informed about product updates, subscribe to the Siemens Industrial Security RSS Feed under (<https://www.siemens.com/cert>).

Disclaimer for third-party software updates

This product includes third-party software. Siemens AG only provides a warranty for updates/patches of the third-party software, if these have been distributed as part of a Siemens software update service contract or officially released by Siemens AG. Otherwise, updates/patches are undertaken at your own risk. You can find more information about our Software Update Service offer on the Internet at Software Update Service (<https://support.industry.siemens.com/cs/ww/en/view/109759444>).

Notes on protecting administrator accounts

A user with administrator privileges has extensive access and manipulation options in the system.

Therefore, ensure there are adequate safeguards for protecting the administrator accounts to prevent unauthorized changes. To do this, use secure passwords and a standard user account for normal operation. Other measures, such as the use of security policies, should be applied as needed.

2.2 Security management for HMI devices

You can find additional information on security management of HMI devices on the Internet at the following address:

Panel Security Guidelines (<https://support.industry.siemens.com/cs/de/en/view/109481300>)

2.3 Data protection

Siemens observes the data protection guidelines, especially the requirements regarding data minimization (privacy by design). This means the following for this SIMATIC product: The product does not process / save any personal information, but only technical functional data (e.g. time stamps). If the user links this data to other data (e.g. shift plans) or if the user saves personal information on the same medium (e.g. hard disk) and therefore creates a personal reference in the process, the user has to ensure meeting the guidelines regarding data protection.

2.4 Notes about usage

NOTICE
The HMI device is approved for indoor use only.
The HMI device may be damaged if it is operated outdoors.
Operate the HMI device indoors only.

Note**Operate the device only in a normal atmospheric environment**

The technical characteristics of the device described in the operating instructions are guaranteed if you operate the device in normal ambient air conditions with usual air composition.

Note

The device is intended for operation in an SELV/PELV circuit according to IEC/EN 61131 or IEC/EN 61010-2-201 in a dry environment, which means a dry environment on the rear of the device.

You can find additional information in the section "Operating conditions (Page 198)".

Industrial applications

The HMI device is designed for industrial applications. It conforms to the following standards:

- Requirements on interference emission EN 61000-6-4:2019
- Requirements on immunity: EN 61000-6-2:2019

Use in mixed-use zone

Under certain circumstances you can use the HMI device in a mixed-use zone. A mixed-use zone is used for housing and commercial operations that do not have a significant impact on residents.

When you use the HMI device in a mixed-use zone, you must ensure that the limits of the generic standard EN 61000-6-3 regarding emission of radio frequency interference are observed. Suitable measures for achieving these limits for use in a mixed-use zone include:

- Installation of the HMI device in grounded control cabinets
- Use of filters in electrical supply lines

Individual acceptance is required.

Use in residential areas

Note

HMI device not intended for use in residential area

The HMI device is not intended for use in residential areas. Operation of an HMI device in residential areas can have a negative influence on radio or TV reception.

Use with additional measures

The HMI device should not be used at the following locations unless additional measures are taken:

- In locations with a high degree of ionizing radiation
- In locations with severe operating conditions, for example, due to:
 - Corrosive vapors, gases, oils or chemicals
 - Strong electrical or magnetic fields of high intensity
- In systems that require special monitoring, for example, in:
 - Elevators
 - Systems in especially hazardous areas

2.5 Use in hazardous areas

The following warnings apply to operating a device with Ex approval in hazardous areas.

 WARNING
<p>Do not plug or pull connectors in potentially explosive atmospheres</p> <p>When you plug or pull the plug-in connector during operation, there is a risk of an arc over. An explosion can be triggered in the hazardous area due to sparkover, and death or serious bodily injury can occur.</p> <p>Pulling or plugging of plug-in connectors, for example, a 24 V DC power supply connector as well as the memory card is prohibited in the hazardous area.</p> <p>Plug or pull a plug-in connector only when one of the following two requirements is met: The area is no longer hazardous or the device and its plug-in connections are de-energized.</p> <p>To switch off the device, close all open programs or the current project, and switch off the power to the device.</p>

Note on using the HMI device within the scope of UL approval:

 WARNING
<p>Explosion Hazard</p> <p>Do not disconnect while circuit is live unless area is known to be non-hazardous. Substitution of components may impair suitability for Class I, Division 2 or Zone 2.</p> <p>Risque d'Explosion</p> <p>Ne pas déconnecter pendant que le circuit est sous tension, sauf si la zone est non-dangereuse. Le remplacement de composants peut compromettre leur capacité à satisfaire à la Classe I, Division 2 ou Zone 2.</p>

Also read the enclosed documentation for use in potentially explosive atmospheres and the information in the section "Certificates and approvals (Page 189)".

Safety instructions

2.5 Use in hazardous areas

www.nicsanat.com

021-87700210



Mounting and connecting the device

3.1 Preparing for installation

3.1.1 Selecting installation location

Points to observe when selecting the mounting location:

- Position the HMI device so that it is not subjected to direct sunlight.
- Position the HMI device such that it is ergonomically accessible for the operator. Choose a suitable mounting height.
- Ensure that the HMI device air vents are not covered as a result of installation.
- Note the permitted mounting positions.

3.1.2 Checking the delivery

Check the package content for visible signs of transport damage and for completeness.

Note**Damaged parts**

A damaged part will cause the HMI device to malfunction.

Do not install parts damaged during shipment. In the case of damaged parts, contact your Siemens representative.

Check the scope of supply of the HMI device, see section "Scope of delivery (Page 15)".

Additional documents may be included in the delivery.

The documentation is part of the HMI device and is required for subsequent commissioning. Keep all enclosed documentation for the entire service life of the HMI device. You must pass along the enclosed documentation to any subsequent owner or user of the HMI device. Make sure that every supplement to the documentation that you receive is stored together with the operating instructions.

3.1.3 Checking the operating conditions

Note the following aspects before installing the HMI device:

1. Familiarize yourself with the standards, approvals, EMC parameters and technical specifications for operation of the HMI device. This information is available in the following sections:
 - Certificates and approvals (Page 189)
 - Electromagnetic compatibility (Page 195)
2. Check the mechanical and climatic ambient conditions for operation of the HMI device: Technical information (Page 189).
3. Read the notes on the local use of the HMI device: Notes about usage (Page 29).
4. Note the permissible rated current: +24 V DC

3.1.4 Permitted mounting positions

The HMI device is suitable for installation in:

- Mounting cabinets
- Control cabinets
- Switchboards
- Consoles

In the following, all of these mounting options are referred to by the general term "cabinet".

The device is self-ventilated and approved for inclined mounting at angles up to $\pm 35^\circ$ from the vertical.

NOTICE

Damage due to overheating

An inclined installation reduces the convection by the HMI device and therefore the maximum permitted ambient temperature for operation.

If there is sufficient convection from forced ventilation, the HMI device can also be operated in the inclined mounting position up to the maximum permitted ambient temperature for vertical mounting. The HMI device may otherwise be damaged and its certifications and warranty will be void.

The working temperature ranges listed in this section apply to the rear and the front of the HMI device.

For detailed information regarding the permitted ambient temperatures, refer to section "Climatic ambient conditions (Page 197)".

Mounting position

Select one of the approved mounting positions for your HMI device. The approved mounting positions are described in the following sections with KP700 Comfort and TP700 Comfort as examples.

Mounting in landscape format

All HMI devices are suitable for landscape mounting positions.

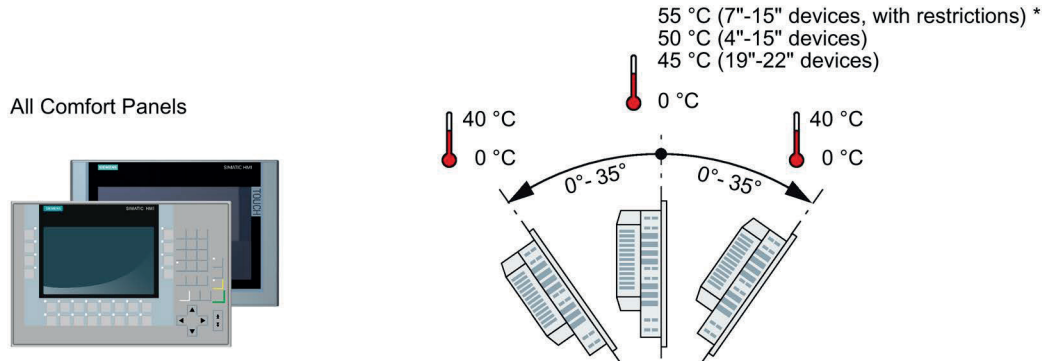

* For 7" to 15" Comfort devices with specific restrictions, an ambient temperature of up to +55 °C is permitted, see the note below.

Note

Extended inclination and ambient temperature range

You can operate 7" to 15" devices with extended inclination and extended temperature range under the following conditions:

- The USB load does not exceed 100 mA per USB port.
- The +24 V DC connection of the PROFIBUS interface is not used.
- The relative humidity conforms to the climate diagram (Page 199).

The following mounting positions and temperature ranges are permitted under the specified conditions:

- Vertical mounting in landscape format with a maximum ambient temperature of +55 °C
- Mounting in landscape format with an inclination of up to 40° from the vertical with a maximum ambient temperature of 40 °C

Mounting in portrait format

The Touch HMI devices are also suitable for mounting in portrait format. Select the appropriate screen format during configuration.

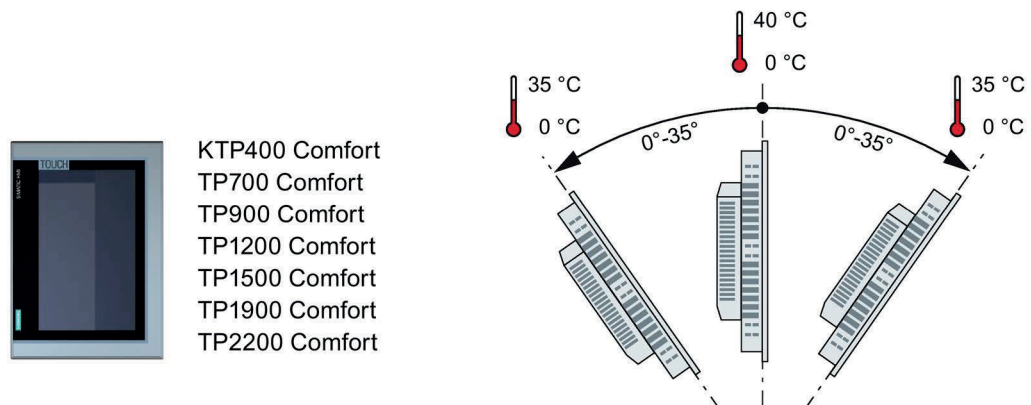

KTP400 Comfort
 TP700 Comfort
 TP900 Comfort
 TP1200 Comfort
 TP1500 Comfort
 TP1900 Comfort
 TP2200 Comfort

3.1.5 Checking clearances

The following clearances are required around the HMI device to ensure sufficient self-ventilation:

- At least 15 mm to both the right and left of the mounting cutout (in x direction) to allow for insertion of the mounting clips during installation
- At least 50 mm above and 50 mm below the mounting cutout (in the y direction) for ventilation
- At least 10 mm behind the rear panel of the HMI device (in the z direction)

The following figure shows the clearances for mounting the KP700 Comfort in landscape and portrait formats as an example:

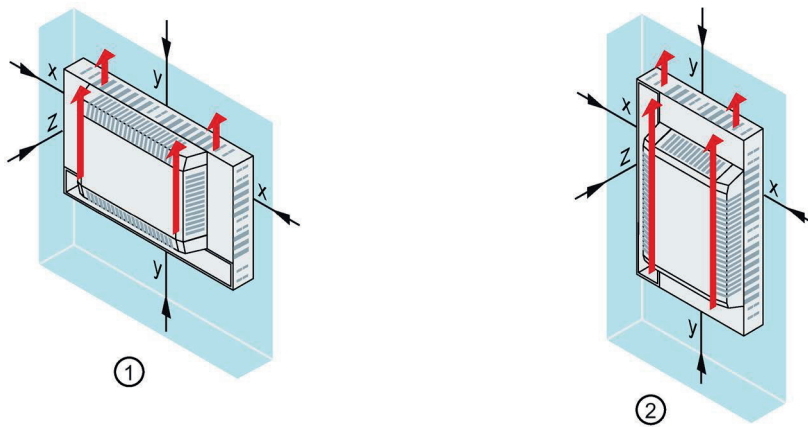

- ① Clearance for mounting in landscape format (all HMI devices)
 - ② Clearance for mounting in portrait format (Touch HMI devices only)
- x At least 15 mm distance
y At least 50 mm distance
z At least 10 mm distance

Note

Ensure that the maximum ambient temperature is not exceeded when mounting the device in a cabinet and especially in a closed enclosure.

3.1.6 Preparing the mounting cutout

Note

Stability of the mounting cutout

The material in the area of the mounting cutout must provide sufficient strength to guarantee lasting and safe mounting of the HMI device.

To achieve the degrees of protection described below, it must be ensured that deformation of the material cannot occur due to the force of the mounting clips or operation of the device.

Degrees of protection and installation area

The degrees of protection of the HMI device can only be guaranteed if the following requirements are met:

- Material thickness at the mounting cutout for a protection rating of IP65 or Front face only Type 4X/Type 12 (indoor use only): 2 mm to 6 mm
- Permissible deviation from plane at the mounting cutout: ≤ 0.5 mm
This condition must also be fulfilled for the mounted HMI device.
- Permissible surface roughness in the area of the seal: ≤ 120 μm (R_z 120)
- The installation area is dry and free from contamination, such as dust or lubricant.

Compatibility of the mounting cutout to other HMI devices

The mounting cutouts of the following HMI devices are compatible with the mounting cutouts of the following predecessor devices:

HMI device	Mounting cutout compatible with
KP400 Comfort	OP 77B
KTP400 Comfort	TP 177B 4"
KP700 Comfort	OP 277 6"
TP700 Comfort	TP 177B 6", MP 177 6", TP 277 6"
KP900 Comfort	MP 277 8" key
KP1500 Comfort	MP 377 12" key

Please note that although the dimensions for the mounting cutout are the same, the device depth and/or the enclosure front dimensions may differ from the respective dimensions of the predecessor devices.

Dimensions of the mounting cutout

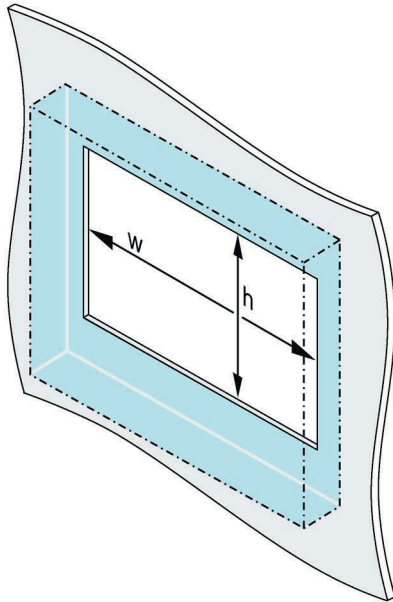

	w_0^{+1}	x	h_0^{+1}	
KP400	135	x	171	mm
KTP400	122	x	98	mm
KP700	281	x	177	mm
TP700	197	x	141	mm
KP900	338	x	206	mm
TP900	250	x	166	mm
KP1200	434	x	268	mm
TP1200	310	x	221	mm
KP1500	450	x	291	mm
TP1500	396	x	291	mm
TP1900	465	x	319	mm
TP2200	542	x	362	mm

Width and height should be reversed accordingly when mounting in portrait format.

3.1.7 Labeling the function keys

Use the labeling strips to label the function keys of the HMI devices based on the project.

You will find labeling strip templates with a scale of 1:1 as a Word file:

- On the Internet at:
Downloads for Comfort Panels
(<https://support.industry.siemens.com/cs/ww/en/ps/14742/dl>)
- In the "Support" folder on the WinCC installation DVD

If you would like to make your own labeling strips, you can find the dimensions under "Dimensions for labeling strips (Page 217)".

Note

Do not write on the keyboard to label the function keys.

Any printable and writable film can be used as labeling strip. The permitted thickness of the labeling strip is 0.15 mm. Do not use paper labeling strips.

Procedure

Proceed as follows:

1. Edit the template on a PC and then print it.
2. Apply a fixation spray film to the labeling strips.
The printout can be made water and smudge-proof with a fixation spray. The color printer ink will not bleed onto the keyboard film as well.
3. Cut out the labeling strip.
4. Cut the corners at a 45° angle so that it is easier to slide the strip into the slot.
5. When the ink has dried, slide the labeling strips into the slot up to the end of the guide.

The figure below shows the guides and labeling strips for the bottom two rows of keys on the KP1200 Comfort.

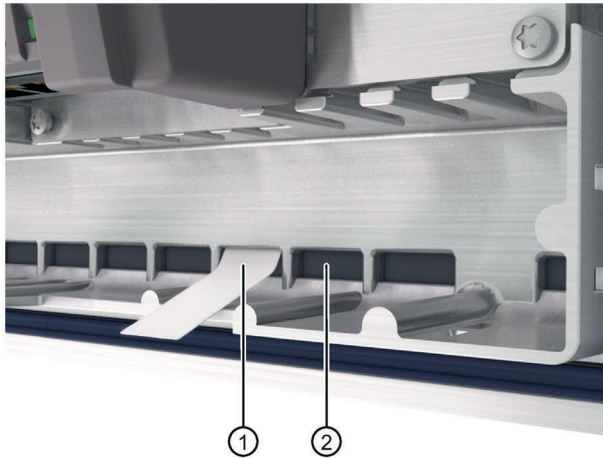

- ① Labeling strips
- ② Guide; the maximum number of guides depends on the HMI device used

The figure below shows the positions of the guides for labeling strips with Comfort V1 device, KP1500 Comfort, as an example.

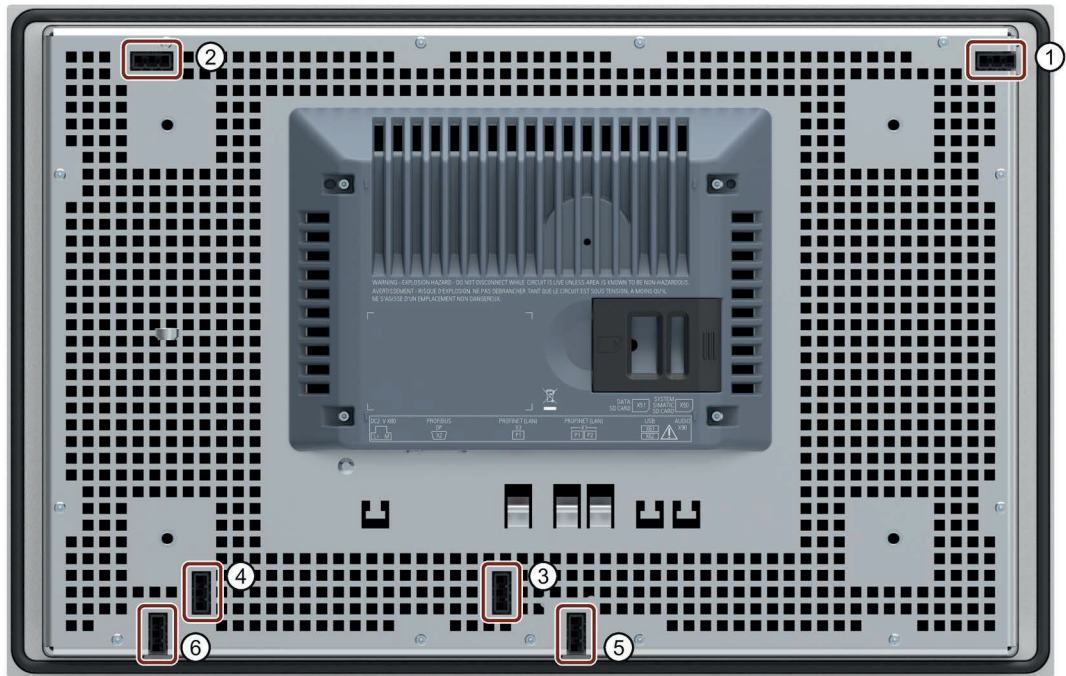

- ① Guide for labeling strips F1, F3 ... F15
- ② Guide for labeling strips F2, F4 ... F16
- ③ Guide for labeling strips F17 ... F22
- ④ Guide for labeling strips F23 ... F26
- ⑤ Guide for labeling strips F27 ... F31
- ⑥ Guide for labeling strips F32 ... F36

Result

The labeling strips protrude approximately 3 cm out of the slot. The template dimensions for the labeling strips are designed in such a way that the labeling of the function keys is correctly placed. Additional securing of the labeling strips is not necessary.

When mounting the HMI device, make sure that the labeling strips do not get jammed between the mounting cutout and the HMI device.



3.2 Mounting the device



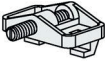

Positions of the mounting clips

To achieve the degree of protection for the HMI device, the positions for the mounting clips shown below must be adhered to.

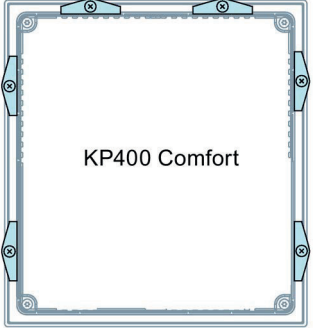
The positions of the mounting clips are marked by stamps on the cutouts. Insert mounting clips in all stamped cutouts.

The following table shows the type, number and position of the mounting clips needed for the respective HMI devices.

Comfort HMI device	Mounting clips		
	Type	Quantity	Position on the HMI device
KTP400	Plastic mounting clips 	4	
KP400		6	

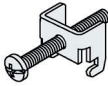
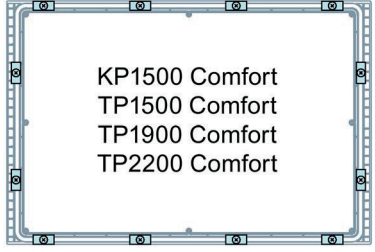
Comfort HMI device	Mounting clips		
	Type	Quantity	Position on the HMI device
TP700	Aluminum mounting clips 	10	 TP700 Comfort
KP700 TP900 TP1200		12	 KP700 Comfort TP900 Comfort TP1200 Comfort
KP900 KP1200		16	 KP900 Comfort KP1200 Comfort
KP1500 TP1500 TP1900 TP2200	Steel mounting clips 	12	 KP1500 Comfort TP1500 Comfort TP1900 Comfort TP2200 Comfort

Requirement

- All packaging components and protective films were removed from the HMI device.
- To install the HMI device, you need the mounting clips from the accessories kit.
- The mounting seal must be installed on the HMI device.

Procedure

Note

Risk of guaranteed degree of protection not being met in case mounting seal is damaged

If the mounting seal is damaged or protrudes beyond the HMI device, the degree of protection is not ensured.

Do not install the HMI device in this case and contact your Siemens representative.

Note

Installation of the HMI device

Always mount the HMI device according to the instructions in this manual.

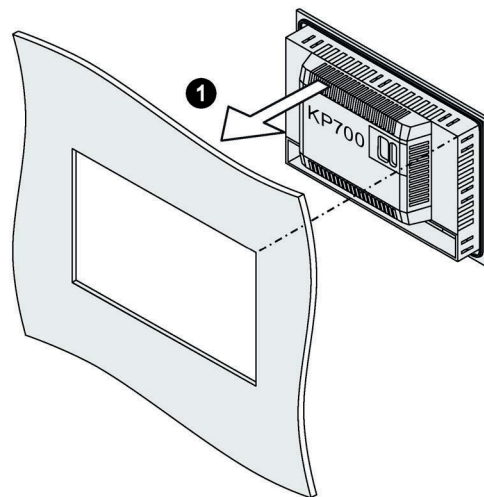

Mounting clips for 4" models:

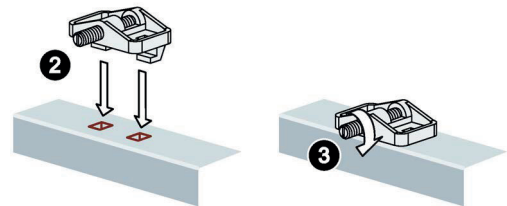

Mounting clips for 7", 9", and 12" models:

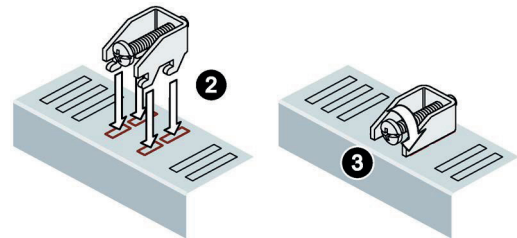

Mounting clips for 15", 19" and 22" models:

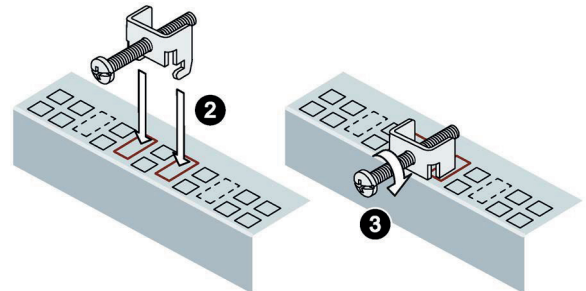

Proceed as follows:

1. Insert the HMI device into the mounting cutout from the front. The figure shows a KP700 Comfort as an example.
2. Insert the mounting clip into the cutout provided on the HMI device.

3.2 Mounting the device

3. Tighten the set screw or the cylinder head screw to secure the mounting clip.

Note

Adhere to the permitted torque when tightening the set screw or the cylinder head screw:

- 4" model: 0.2 Nm
 - 7" to 22" models: 0.5 Nm
-

4. Repeat steps 2 and 3 for all mounting clips.
5. Check the fit of the mounting seal.

Result

The HMI device is mounted and the relevant degree of protection is ensured at the front.

See also

Accessories (Page 22)

3.3 Connecting the device

3.3.1 Notes on connection

Requirement

- The HMI device must be mounted according to the specifications of these operating instructions.

Connecting cables

Use only shielded standard cables as data connecting cables, order information is available on the Internet (<https://mall.industry.siemens.com>).

Note

Separate SELV/PELV circuits from other electric circuits or insulate the cables

The wiring of SELV/PELV circuits must either be separated from the wiring of other non-SELV/PELV electric circuits, or the insulation of all conductors must be rated for the higher voltage. Alternatively, a grounded shield or additional insulation must be installed around the wiring for SELV/PELV circuits or the other electric circuits, based on IEC 60364-4-41.

Note on using the HMI device within the scope of UL approval:

Note

Use copper cables at connectors with terminal connections

Use copper (Cu) cables for all supply lines that are connected to the device with terminals, e.g. 24 V DC power supply cables to the 24 V DC power supply connectors.

Utiliser des câbles en cuivre sur les connexions à bornes

Utilisez des câbles en cuivre (Cu) pour tous les câbles d'alimentation qui sont raccordés à l'appareil par des bornes, par exemple les câbles d'alimentation 24 V CC sur le connecteur d'alimentation 24 V CC.

Connection sequence

NOTICE

Damage to the HMI device

If you do not keep to the connection sequence you could damage the HMI device.

It is crucial that you connect the HMI device in the following order:

1. Equipotential bonding
2. Power supply
Perform a power-up test to ensure the power supply is connected with the correct polarity.
3. Controller
4. Configuration PC if needed
5. I/Os if needed

Disconnect the HMI device by completing the above steps in reverse order.

Connecting the cables

NOTICE

Observe local installation regulations

Observe the local installation regulations and the local installation conditions, such as protective wiring for power supply cables, when connecting the cables.

NOTICE

Thermal stability and insulation of the cables

Use cables with a maximum permissible operating temperature that is at least 20 °C higher than the maximum ambient temperature.

The insulation of the cables must be suitable for the operating voltage.

NOTICE

Short-circuit and overload protection

Different measures for short-circuit and overload protection are required when setting up an entire plant. The type of components and the level of obligation for the protective measures depends on the regulation that applies to your plant configuration.

- When connecting the cables, make sure that you do not bend the contact pins.
- Secure the cable connectors by fastening the connector to the socket with screws.
- Provide adequate strain relief for all connecting cables.
- The pin assignment of the ports is described in the technical specifications.

3.3.2 Equipotential bonding

Differences in electrical potential

Differences in electrical potential can develop between spatially separate system components. Such electrical potential differences can lead to high equalizing currents across the data cables and therefore to the destruction of their interfaces. Equalizing currents can develop if the cable shielding is terminated at both ends and grounded to different system parts.

Differences in potential may develop when a system is connected to different mains supplies.

General requirements for equipotential bonding

Differences in potential must be reduced by means of equipotential bonding in order to ensure trouble-free operation of the relevant components of the electronic system. The following must therefore be observed when installing the equipotential bonding circuit:

- The effectiveness of equipotential bonding increases as the impedance of the equipotential bonding conductor decreases or as its cross-section increases.
- If two system parts are interconnected by means of shielded data cables and their shielding is bonded at both ends to the grounding/protective conductor, the impedance of the additionally installed equipotential bonding cable must not exceed 10% of the shielding impedance.
- The cross-section of an equipotential bonding conductor must be capable of handling the maximum equalizing current. Equipotential bonding cables are required between two control cabinets with a minimum conductor cross-section of 16 mm².
- Use equipotential bonding conductors made of copper or galvanized steel. Establish a large surface contact between the equipotential bonding conductors and the grounding/protective conductor and protect them from corrosion.
- Clamp the shield of the data cable from the HMI device flush at the equipotential bonding rail using suitable cable clamps. The equipotential bonding rail should be as close to the HMI device as possible.
- Route the equipotential bonding conductor and data cables in parallel and with minimum clearance in between.

Note

Equipotential bonding cable

Cable shields are not suitable for equipotential bonding. Always use the prescribed equipotential bonding conductors for this. An equipotential bonding conductor between control cabinets must have a minimum cross-section of 16 mm². The cable between the ground bar and HMI device must have a minimum cross-section of 4 mm². Always use cables with an adequate cross-section when installing MPI and PROFIBUS DP networks. Otherwise, the interface blocks may be damaged or destroyed.

Wiring diagram

The following figure shows the connection of the functional ground for equipotential bonding with KP700 Comfort as an example and similarly applies to the other Comfort devices.

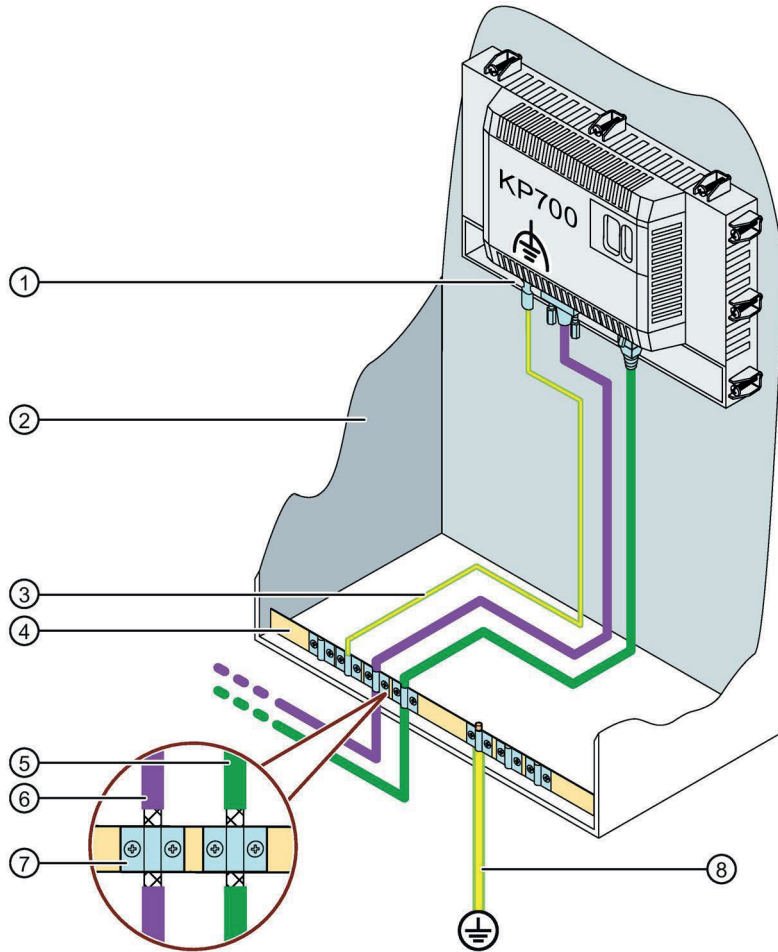

- ① Connection for functional ground
- ② Control cabinet
- ③ Equipotential bonding cable, 4 mm²
- ④ Equipotential busbar for equipotential bonding cables, grounding connection and shield support of the data cables
- ⑤ PROFINET data cable
- ⑥ PROFIBUS data cable
- ⑦ Cable clip
- ⑧ Ground bar, 16 mm²

3.3.3 Connecting the power supply

NOTICE

Safe electrical isolation

For the 24 V DC supply, only use power supply units with safe electrical isolation (SELV/PELV) in line with IEC 61010-2-201.

The supply voltage must be within the specified voltage range. Otherwise, malfunctions at the HMI device cannot be ruled out.

The following applies for a non-isolated system design: Connect the GND 24 V connection from the 24 V power supply output to equipotential bonding for uniform reference potential. You should always select a central point of termination.

NOTICE

External protective wiring required for Comfort V1/V1.1 devices

The following applies to Comfort V1/V1.1 devices: An external protective circuit is required for operation with 24 V DC, see section 7 "Lightning protection and overvoltage protection" in function manual "Designing interference-free controllers

(<https://support.industry.siemens.com/cs/ww/en/view/59193566>)".

Wiring diagram

The following figure shows the connection between the power supply and the HMI device with TP1500 Comfort V2 as an example.

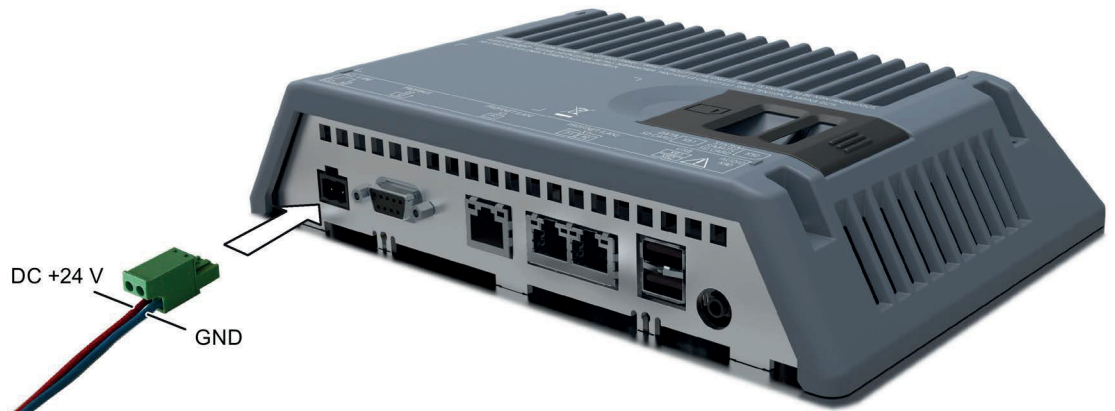

Note when connecting

The power supply connector is contained in the accessory kit. The power supply connector is designed for cables with a maximum cross-section of 1.5 mm². Torque for the screws: 0.5 to 0.6 Nm.

Additional information on the supplied power supply connectors and additional permitted power supply connectors can be found in the section "Accessories (Page 22)."

Connecting the power supply connector

NOTICE

Do not damage the socket

Do not tighten the screws of the power supply connector when it is plugged into the HMI device. The pressure from the screwdriver could damage the HMI device socket.

Connect the power supply cables when the power supply connector is unplugged from the HMI device.

1. Switch off the power supply.
2. Connect the power supply cables to the power supply connector as shown in the above figure, torque 0.5 to 0.6 Nm.
3. Connect the power supply connector to the corresponding socket of the HMI device as shown in the above figure. Check the correct polarity of the cables using the interface marking on the back of the HMI device.

Reverse polarity protection

The HMI device comes with electronic reverse polarity protection which prevents the device from being damaged in case the power supply cables are connected incorrectly.

Connecting the uninterruptible power supply

The following figure shows how to connect an uninterruptible power supply (UPS) to the HMI device with TP1500 Comfort V2 as an example. The uninterruptible power supply is connected to the connection for the power supply and to a Type A USB port of the HMI device.



The following uninterruptible power supplies are supported for connection to the USB port of the HMI device: SITOP DC UPS modules as of a rated power value of 6 A

See also

Setting the uninterruptible power supply (Page 158)

3.3.4 Connecting the configuration PC

Wiring diagram

The following figure shows how to connect a Comfort V1 device to a configuration PC with TP1500 Comfort V1 as an example.

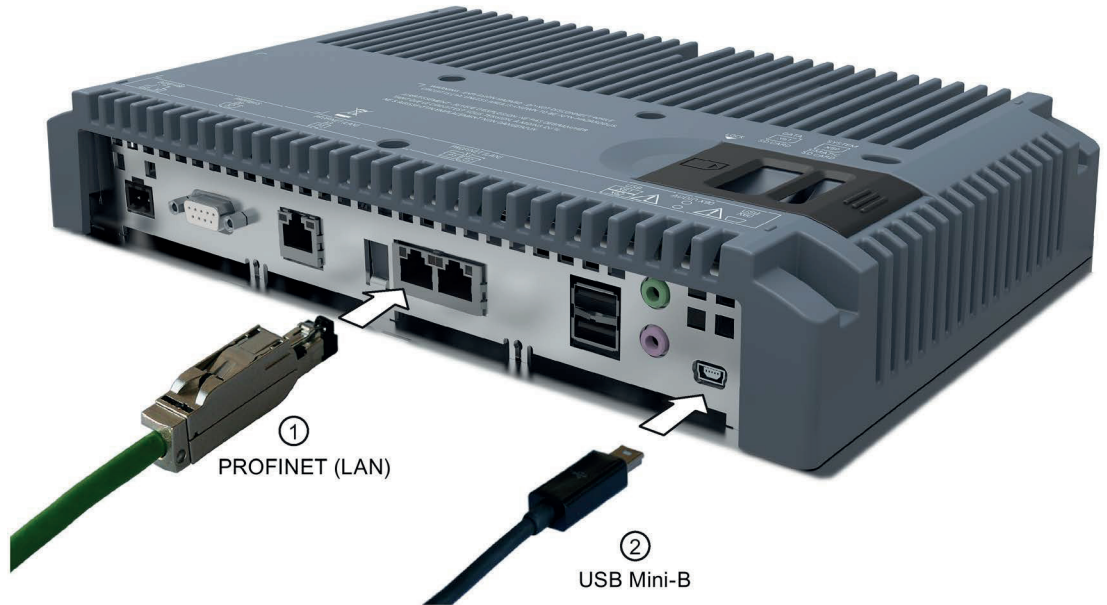

The Comfort V1.1 devices are connected in the same way.

The following figure shows how to connect a Comfort V2 device to a configuration PC with TP1500 Comfort V2 as an example.



3.3 Connecting the device

The interfaces are described in the specifications.

Note

You can also connect the HMI device to the configuration PC via PROFIBUS. But the transmission rate may result in extremely long transfer times.

Information on the USB type Mini-B interface

Note

USB type Mini-B interface only suitable for commissioning

The USB type Mini-B interface is not intended for connecting peripheral devices.

The USB type Mini-B interface may be used for commissioning and maintenance only.

Note

At least USB 2.0 certified cables required

If you use USB cables which are certified below USB 2.0, errors may occur during data transfer.

Use only USB cables that have the marking "Certified HI-SPEED USB 2.0" or higher.

Note

USB cable length maximum 1.5 m

USB cables with lengths of more than 1.5 m do not ensure secure data transfer.

The cable length of the connected USB devices may not exceed 1.5 m.

Procedure

Proceed as follows:

1. Switch off the HMI device.
2. Switch on the configuration PC.
3. Comfort V1/1.1 devices: Connect the HMI device to the configuration PC using either the PROFINET (LAN) interface or the USB type Mini-B interface. Please note the following for USB connection:
 - Connect the USB Mini-B connector of the USB cable to the USB type Mini-B interface of the HMI device.
 - Connect the USB A connector of the USB cable to a free USB interface of the configuration PC.Comfort V2 devices: Connect the HMI device to the configuration PC via the PROFINET (LAN) interface.
4. Switch on the HMI device.

Result

The configuration PC and HMI device are connected.

If you have connected the HMI device directly to the configuration PC using the PROFINET (LAN) interface, you have to assign an IP address to the HMI device afterwards.

If Windows XP is installed on the configuration PC and you have connected the HMI device to the configuration PC via USB, you will be prompted to install the USB driver. You can find the USB driver in the installation folder of WinCC.

Note

Updating the operating system

If there is no serviceable HMI device image on the HMI device, you can only update the operating system by restoring the factory setting. When restoring the factory settings, connect the PC to the HMI device using the PROFINET (LAN) interface.

Note

Connecting multiple HMI devices in succession

If you connect more than one HMI device with the same IP address in succession to a single configuration PC, you need to ping the configuration PC once from the HMI device on each changeover of the HMI device.

3.3.5 Connecting the controller

Wiring diagram

The following figure shows how to connect the HMI device to a controller with TP1500 Comfort V2 as an example.

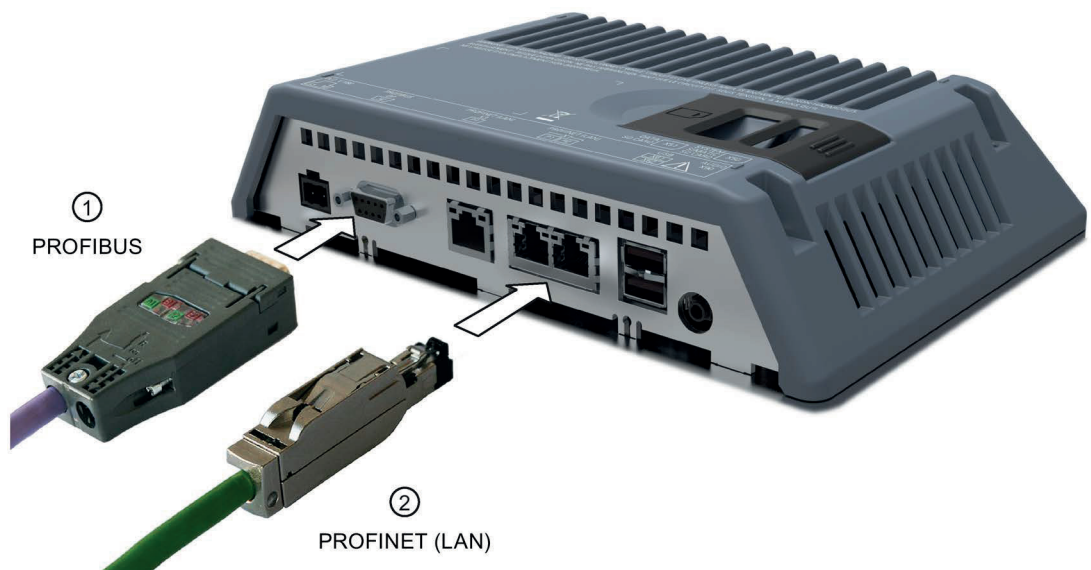

Note

Use approved cables only

If you do not use approved cables to connect a SIMATIC S7 controller, you may experience malfunctions.

Use only approved cables to connect a SIMATIC S7 controller.

Note

Use only straight connectors

Use only straight cables whenever possible to connect a controller. Bent connectors can cover adjacent interfaces.

For KP700 and TP900 Comfort, use only a straight connector at interface X2 PROFIBUS.

Standard cables are available for the connection. Additional information is available on the Internet at Industry Mall (<https://mall.industry.siemens.com>).

Connecting PROFINET

Note

PROFINET IO communication

For instructions regarding the installation of PROFINET networks, refer to the "PROFINET System Description" manual.

The following applies to devices with displays 7" or larger: The HMI device has an internal switch. You can set up a ring topology, for example, with the HMI device without an external switch. Use the X1 interface to set up a ring topology for devices with a 15" display or larger.

See also

Communication with controllers (Page 232)

3.3.6 Connecting a USB device

Below are examples of devices designed for industrial use you can connect to the USB type A interfaces of the HMI device:

- External mouse
- External keyboard
- Printer
- USB stick
- Industrial USB Hub 4, article number 6AV6671-3AH00-0AX0
- Mobile handheld reader ("Barcode Scanner"), article number 6GF3320-OHT01 or 6GF3340-OHT01
- Reader SIMATIC RF1060R ("RFID Reader"), article number 6GT2831-6AA50

Note when connecting

Note**USB type A interface not suitable for commissioning**

The USB type A interface is only intended for the connection of peripheral devices.

Do not use the USB type A interface for commissioning or maintenance.

Note**At least USB 2.0 certified cables required**

If you use USB cables which are certified below USB 2.0, errors may occur during data transfer.

Use only USB cables that have the marking "Certified HI-SPEED USB 2.0" or higher.

Note**USB cable length maximum 1.5 m**

USB cables with lengths of more than 1.5 m do not ensure secure data transfer.

The cable must not be longer than 1.5 m.

Note**Functional problem with USB port**

If you connect a USB device with its own power supply to the USB interface, make sure that the USB ground terminal of the external device is connected to ground.

Note**Excessive rated load on port**

A USB device with too high a power load may possibly cause functional problems.

Observe the values for the maximum load of the USB interface. You will find the values in the section "Technical specifications (Page 219)".

3.3.7 Connecting a printer

Wiring diagram

The following figure shows how to connect the HMI device to a printer with TP1500 Comfort V2 as an example.

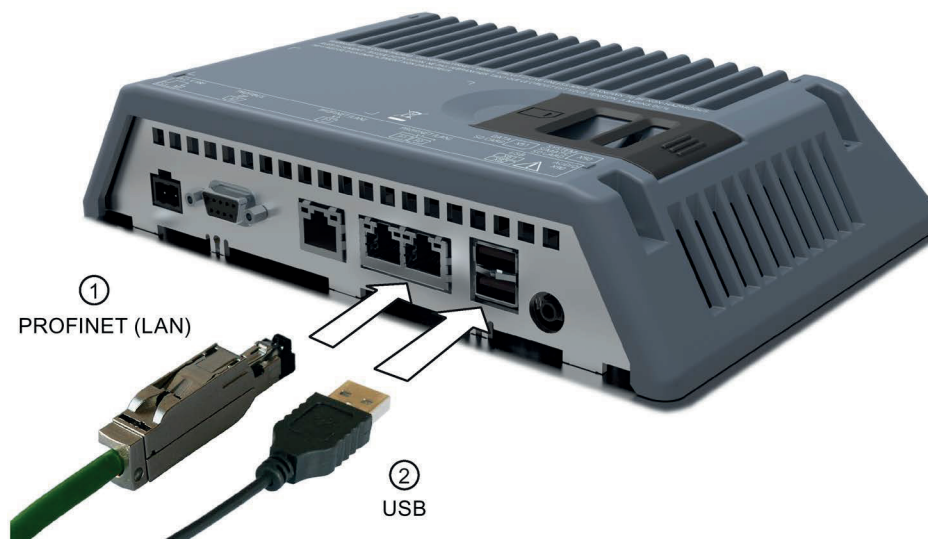

Note when connecting

Note

Cables for data exchange

If you use cables without a metallic netting shield between the HMI device and printer, you may experience functional problems.

Use cables with metal-braided shielding grounded at both ends only for connecting the HMI device and the printer.

Note

Some printers may require that you also set the ASCII character set used in the project on the printer.

You can find a list of current printers and required settings for HMI devices on the Internet at "Approved printers for SIMATIC HMI Panels (<https://support.industry.siemens.com/cs/ww/en/view/11376409>)".

Observe the supplied printer documentation when you connect the printer.

3.3.8 Connecting an audio device

You can use the "Line Out" port for audio output devices, such as active speakers or audio amplifiers.

Note**Cable to "Line Out" interface may cause increased emitted interference**

If you connect an audio device to the "Line-Out" interface, the connection cable of the audio may cause increased emitted interference.

You should only use insufficiently shielded audio devices, such as headsets and headphones, during commissioning at the "Line-Out" interface.

If you use audio devices during productive operation, you need to ensure that the cables of these audio devices are shielded so that they comply with the applicable guidelines relating to emitted interference.

See also

Certificates and approvals (Page 189)

Electromagnetic compatibility (Page 195)

3.3.9 Switching on and testing the device

Procedure

1. Switch on the power supply. The display lights up.

If the HMI device fails to start, you may have crossed the cables on the power supply connector. Check the connected cables and correct the polarity if necessary. Once the operating system starts, the desktop with the Start Center is displayed:

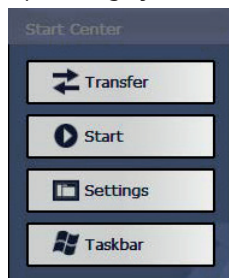

3.3 Connecting the device

The HMI device automatically switches to "Transfer" mode during initial startup under the following circumstances:

- No project is loaded on the HMI device.
- At least one data channel has been configured.

During this process the following dialog appears:

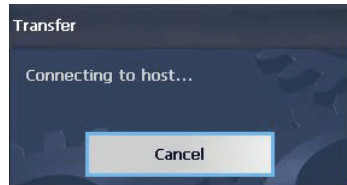

2. Press "Cancel" to stop the transfer.

Result

The desktop with the Start Center is displayed again.

Note

When restarting the system, a project may already be loaded on the HMI device. The project will then start after a configurable delay or when you press the "Start" button.

Use the relevant operating element to close the project.

Refer to your system documentation to find any additional information on this topic.

Function test

Perform a function test following commissioning. The HMI device is fully functional when one of the following states is indicated:

- The "Transfer" dialog is displayed.
- The Start Center is displayed.
- A project is started.

Switching off the HMI device

1. Close the project on the HMI device.
2. Switch off the power supply.

See also

Parameterizing Transfer (Page 99)

3.3.10 Securing the cables

After the switch-on test, secure the connected cables for strain relief using cable ties to the existing fastening elements or to the nearest possible fastening point in the control cabinet.

The figure below shows the fastening components with the TP1500 Comfort V2 device as an example.

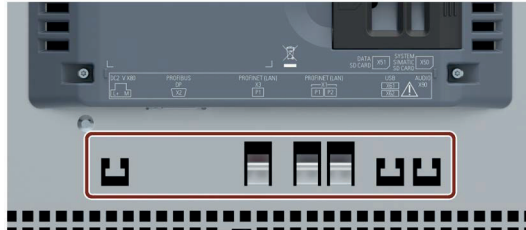

Installing a strain relief

With the 4" and 7" models, protect the cables with a separate strain relief. Install the strain relief on the HMI device.

The following figure shows the fixing elements of the strain relief for the 4" model:

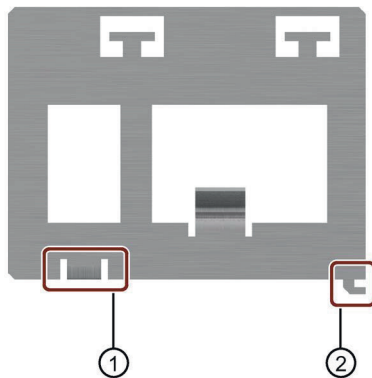

- ① Bore hole for Torx screw
The strain relief plate is fastened with the Torx screw of the connection for functional ground. Before you install the strain relief, remove the Torx screw.
- ② Safety latch

Proceed as follows:

1. Position the strain relief flush with the HMI device.
2. Push the strain relief to the right.
3. Secure the strain relief with the Torx screw.

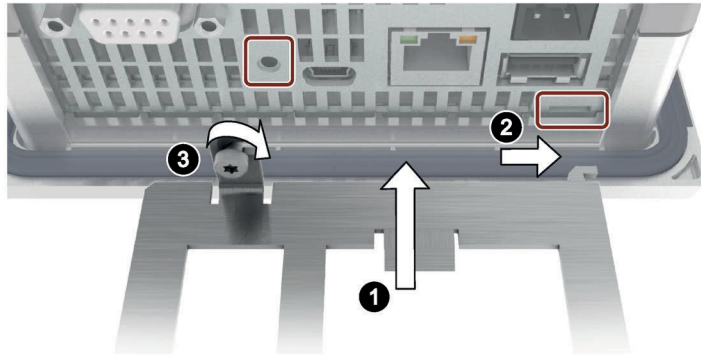

3.3.11 Securing cables for use in hazardous areas

When devices with Ex approval are used in hazardous areas, note that the connectors must be secured in a captive manner at the interfaces.

! WARNING

Explosion hazard from sparks when connectors come loose

If a plug connector comes loose from the associated device interface during operation in a hazardous area, a spark over at the interface may cause an explosion. Death or serious physical injury as well as property damage may result.

For use in hazardous areas, it must be ensured that the plug connectors of the cables are fully connected to the respective interface and cannot come loose from the interfaces in any case. For SIMATIC HMI Comfort Panels, this risk only exists at the USB interfaces.

Secure all connected USB cables directly at the transition between connector and cable to the nearest mounting element using a cable tie. Tighten up all cable ties in such a way that they fully wrap around the respective cable but do not damage the cable.

For securing the connected USB cables, use the appropriate mounting elements, as described in the previous chapter.

The following figure shows an example of how to secure a USB connector in a captive manner.

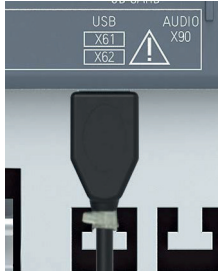

3.4 Removing the device

The HMI device is generally removed in the reverse order used for installing and connecting.

Procedure

Proceed as follows:

1. If a project is running on the HMI device, close the project with the HMI device configured for this purpose. Wait for the Start Center to be displayed.
2. Switch off power to the HMI device.
3. When you use the HMI device in a hazardous area, make sure that one of the two following requirements is met: The area is no longer hazardous or the device and its plug-in connections are de-energized.
4. Remove all cable ties on the HMI device used for strain relief.
5. Remove all plug-in connectors and the equipotential bonding cable from the HMI device.
6. Secure the HMI device so that it cannot fall out of the mounting cutout.
7. Loosen the screws of the mounting clips and remove all mounting clips.
8. Take the HMI device out of the mounting cutout.

See also

Mounting the device (Page 41)

Connecting the device (Page 45)

Commissioning the device

4.1 Overview

4.1.1 Firmware and software

Firmware and software for your HMI device are continually undergoing further developed. Check regularly whether software updates or patches are available for your HMI device and install the latest versions.

You can find the latest updates and patches for your HMI device on the Internet (<https://support.industry.siemens.com>). Enter the article number of your HMI device as a search term and filter the contributions according to the by contribution type "Download".

4.1.2 Memory concept

The HMI devices use the following memory types:

- **Internal memory**
- **Memory card** for data and logs
- **System memory card** for "automatic backup"
- USB port for a **USB storage medium** with data

Note

Using the memory card for logs

Due to the high number of read/write cycles, we recommend that you use the memory card rather than the USB interface for logs.

Internal memory

The following data is saved in the internal memory:

- Operating system
- Project file
- License keys
- User administration
- Recipes*
- Other data, such as documents or media files

* To store recipes in the internal memory, select "\Flash\" as the path in WinCC.

Note

Cyclic write access to the internal memory is not permitted

Cyclic write access to internal memory is not permitted, because it reduces the service life of the internal memory and of the HMI device, for example, during configuration in which permanent system alarms or user-defined messages are generated in the alarm buffer.

Configure an alarm window, check the number and frequency of the alarms that occur. If you expect a permanent load on the internal memory from alarms, adjust the configuration accordingly.

If the alarms do not have to be stored permanently, you can switch off the retentivity of the alarm buffer, see section "Activate/deactivate retentivity of the alarm buffer on the HMI device (Page 105)".

To prolong the service life of your device, you should preferably use external memory cards to store and log data, such as the SIMATIC HMI Memory Card.

Note

Number of permitted files in the root directory of the internal memory

The number of files in the root directory is limited to 256. The number of files is not limited in the subdirectories of the internal memory.

Memory card

The following data is saved on the memory card:

- Logs
- Data backups
- User data
- Recipes^{*)}

^{*)} To store recipes on the memory card, select "\\Storage Card SD1" as the path in WinCC.

You can use commercially available memory cards with the "SD(IO / HC)" or "MMC" format. For reasons of data consistency, Siemens recommends the use of the SIMATIC HMI Memory Card as memory card, see Accessories (Page 22).

Note

Data consistency

When the HMI device is switched off, consistency of the stored data is ensured only for the SIMATIC HMI Memory Card ≥ 2 GB.

With commercially available memory cards, switching off the device may result in the loss of saved data, for example, due to a power failure.

The consistency of data stored in logs is only guaranteed if you use RDB format.

Note

Frequency

Logs are stored at a frequency of approx. 0.2 Hz. This may result in small amounts of data not being saved shortly before a power failure.

Use a UPS to avoid data loss even shortly before a power failure.

System memory card

The system memory card is part of the service concept of the HMI devices. If you enable the "automatic backup" function, all data from the internal memory of the HMI device is transferred to the system memory card. If the HMI device fails, you insert the system memory card into a replacement device. Once the replacement device starts, you can continue working in your project. This way you reduce your system downtimes to a minimum.

The system memory card is not visible in the user interface of the HMI device and it cannot be used for data storage. In order for the HMI device to recognize the system memory card, you have to insert the system memory card into the slot designed for it.

Note

Format of the system memory card

Only a SIMATIC HMI Memory Card ≥ 2 GB may be used as a system memory card. All other memory cards are not recognized as system memory card by the HMI device.

Slots for memory card and system memory card

The slots for memory card and system memory card are on the back of the enclosure for the 7" models. The memory cards and system memory cards are thus accessible at the rear of the cabinet. The memory cards and system memory cards are protected by a safety catch.

The slots are on the back of the enclosure for the 4" models.

The figure below shows the slots with safety catch with the Comfort V1 devices as examples.

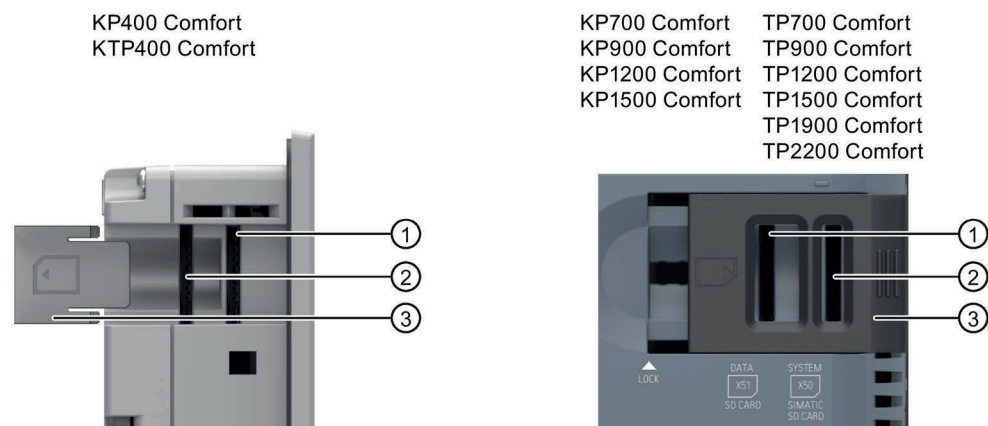

- ① Slot for memory card in the "SD(IO/HC)" or "MMC" format.
Recommendation: SIMATIC HMI memory card
- ② Slot for the system memory card.
Permitted: SIMATIC HMI Memory Card ≥ 2 GB
- ③ Safety catch
KP400 Comfort and KTP400 Comfort: infinitely variable
KP700 Comfort and TP700 Comfort and higher: two-level

4.1.3 Changing the memory cards

The memory cards and system memory cards are protected by a safety catch.

 WARNING
Do not plug or pull a memory card in a hazardous area
If you plug or pull the memory card during operation, you run the risk of a flashover. A flashover can cause an explosion in the hazardous area, resulting in death or severe injuries. Plugging or pulling of a memory card in a hazardous area is prohibited .
Do not plug or pull a memory card until one of the two following requirements is met: The area is no longer hazardous or the device and its plug-in connections are de-energized.

Note**Potential loss of data**

The data on the memory card is lost if you attempt to remove it while the HMI device is accessing its data.

Do not remove the memory card while data is being accessed. Observe the corresponding alarms on the screen.

Note**Do not remove the system memory card for "automatic backup" during operation**

If the "Automatic backup" function is activated, the system memory card may only be removed when the HMI device is switched off. You can find additional information on this subject in the section "Using automatic backup (Page 148)".

Note**Removing the system memory card while the project is running**

If you remove the system storage card while a project is running, the project is ended.

Requirement

No write access to the memory and/or system memory card is currently taking place.

Procedure

Note

Use only a SIMATIC HMI Memory Card as a system memory card

Only the SIMATIC HMI Memory Card ≥ 2 GB may be used as a system memory card. All other memory cards are not recognized as system memory card by the HMI device.

The following description uses a Comfort V1 device with a ≥ 7 " display diagonal as an example.

1. Slide the safety catch into the required position.
2. To remove the memory card and/or system memory card, briefly press the card in question. The card will be released and can be removed. This step is not required during commissioning.

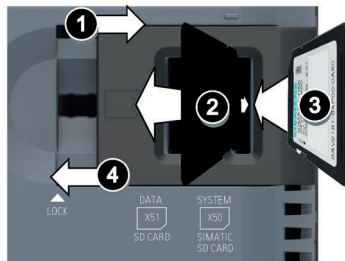

3. Insert the new memory card and/or system memory card.
4. Slide the safety catch back into its original position. When you have inserted the system memory card, you will be prompted by the HMI device to enable the "Automatic Backup" function.

The memory card and/or system memory card is replaced.

See also

Accessories (Page 22)

4.1.4 Front operator controls

Touch HMI devices

You can operate the Touch HMI devices with the touch screen. All operating elements required for operation are displayed on the touch screen once the HMI device has been started.

NOTICE**Damage to the touch screen**

Pointed or sharp objects, abrupt contact, and continuous gesture operation can significantly reduce the life of the touch screen and possibly lead to total failure of the touch screen.

- Do not touch the touch screen with pointed or sharp objects.
- Avoid applying excessive pressure to the touch screen with hard objects.
- Avoid continuous operation of the touch screen with gestures.

NOTICE**Triggering unintended actions**

Touching several operating elements at the same time can trigger unintended actions.

Touch only one operating element on the screen at a time.

Key HMI devices

You operate the key HMI devices using the system keys and the function keys. The functions of the function keys are defined during configuration. The function keys have no function before the project is opened in the HMI device.

The figure below shows the operator controls on the front of the key HMI devices using the KP700 Comfort as an example:

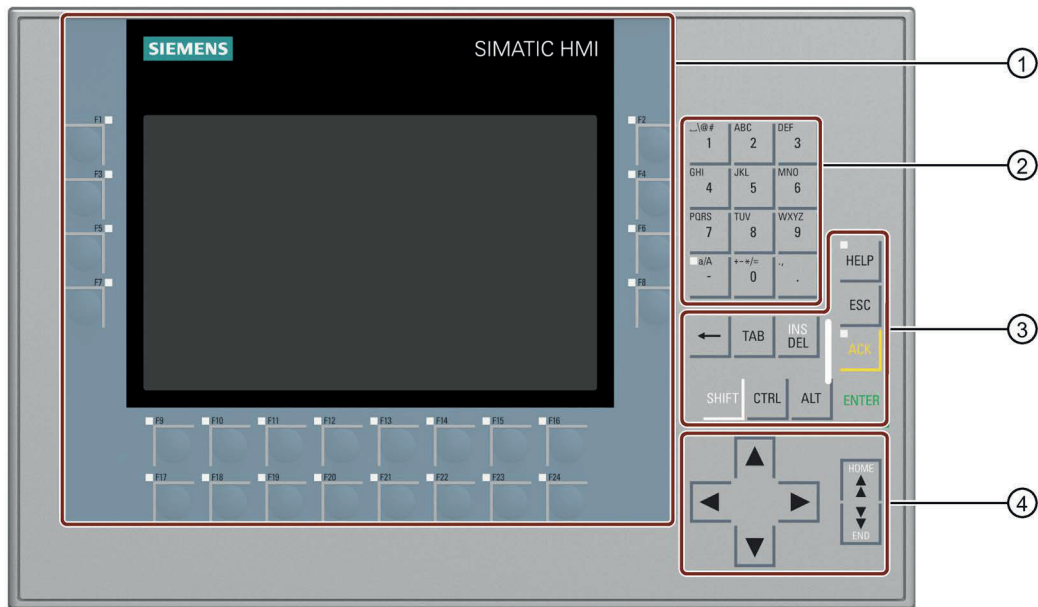

- ① Display and function keys with LED
The number of function keys varies depending on display size
- ② System keys - alphanumeric keys
- ③ System keys – control keys
- ④ System keys - cursor keys

Note

Unintentional action possible

Do not carry out several operations simultaneously. You may otherwise trigger an unintentional action.

Do not press more than two keys at the same time.

Note

Damage to the keyboard possible

Using a hard object to press the keys considerably reduces the service life of the key mechanism.

Always use your fingers to operate the keys of your HMI device.

See also

Accessories (Page 22)

4.2 Operating the device

4.2.1 Reference for system keys

You operate key HMI devices using the system keys.

Alphanumeric assignment of system keys

The following table shows the alphanumeric assignment of the system keys from "0" to "9":

















Key	Alphanumeric assignment
1	<space> @#%?!"':;<>()[]{}€\$&%^°~ _1
2	ABCÄÄ2
3	DEFÈÈ3
4	GHI4
5	JKL5
6	MNOÖ6
7	PRQRSB7
8	TUVÜ8
9	WXYZ9
0	+-*/=0

The characters available for input depend on the entry field involved, e.g. the entry of an alphanumeric value using the system keys.

General functions

















You initiate functions on HMI devices with keys by using a key or keyboard shortcuts. With keyboard shortcuts, hold the first key down. Then press the second button.

The table below shows the system key functions that work both in the Control Panel and in the project:

Key or keyboard shortcut	Function
	Switch between upper and lower case: <ul style="list-style-type: none"> • LED on: Upper case • LED off: Lower case
	Deletes the character left of cursor.
	Moves to the next operating element in the TAB order.
 	Moves to the previous operating element in the TAB order.
	Deletes the character right of cursor.
 	Toggles "overwrite" mode on or off. If "overwrite" mode is switched on, the characters are overwritten to the right of the cursor.
	Cancels an action, for example: <ul style="list-style-type: none"> • Discard entry and close dialog
	Executes a command, for example: <ul style="list-style-type: none"> • Operating buttons • Open dialog or select menu command • Apply value and close dialog
	Moves the cursor, selection or a controller in the specified direction.
	Move the cursor or selection one screen up.
	Move the cursor or selection one screen down.
	Press: Switches to another key mapping. Hold down: Switches between upper and lower case.
	General control function for use in keyboard shortcuts.
	General control function for use in keyboard shortcuts.







Using the operating systems and Explorer

The table below shows the system key functions when using the operating system and the Explorer:

Key or keyboard shortcut		Function
		Enables the taskbar and opens the Start menu.
		Shows the Start Center.
		Opens the task manager.
		Toggles between the desktop and Explorer.
		Navigates to the directory above.
		Selects the first entry.
		Selects the last entry.
		Opens the shortcut menu.
		Displays the properties.





Operating the Control Panel and dialogs

The table below shows the system key functions when operating the Control Panel and dialogs:

Key or keyboard shortcut	Function
	Activates the menu. Use the cursor keys to navigate in the menu.
	Selects or clears a check box.
 	Opens a drop-down list box.
 	Selects a list item without closing the dialog.
	Navigates through tabs or options. Activate the tab or the options, in each case with <TAB>.

Operating a project

The table below shows the system key functions when operating an ongoing project:

Key or keyboard shortcut	Function
	Acknowledges the currently displayed fault or all alarms of an alarm group as group acknowledgment. A lit LED indicates unacknowledged faults.
	Calls up the configured infotext for an operating element. When the LED is lit, it indicates that an infotext is available.
	Enables the operation of an operating element.
 	Position the cursor within an I/O field.

See also

Input of values (Page 180)

Entering and editing numerical values (Page 181)

Entering or changing alphanumeric values (Page 182)

4.2.2 Entering values with system keys

The system keys of the HMI devices have the same operating concept as the keypad of a cell phone. Each system key is assigned several letters and special characters of the alphabet and one number. When you press a system key long enough, the number is automatically inserted.

The figure below shows the entry of an alphanumeric value using system keys for Device name ① and Device description ② of the HMI device:



Requirement

Cursor must be in the text box.

Procedure

Proceed as follows:

1. Press the respective key repeatedly until the desired character is selected in the preview.
The mapping of system keys to letters and numbers can be restricted within a given context.
The desired character is applied in about one second or immediately after pressing a different button.
2. To toggle between upper and a lower case, press <a/A>.



All characters are then either written in upper case or lower case.

3. To navigate within the given character string, use the cursor keys.
4. If you enter values in the Control Panel, you can apply them with <ENTER> or <TAB>:
 - <ENTER>: Closes the dialog.
 - <TAB>: Navigates to the next operating element within the dialog.
5. If you enter values in the project, you can apply them with <ENTER>.

See also

Input of values (Page 180)

Entering and editing numerical values (Page 181)

Entering or changing alphanumeric values (Page 182)

4.3 Parameterizing the Comfort Panel

4.3.1 Desktop and Start Center

Once the HMI device has been started, the display shows the desktop.

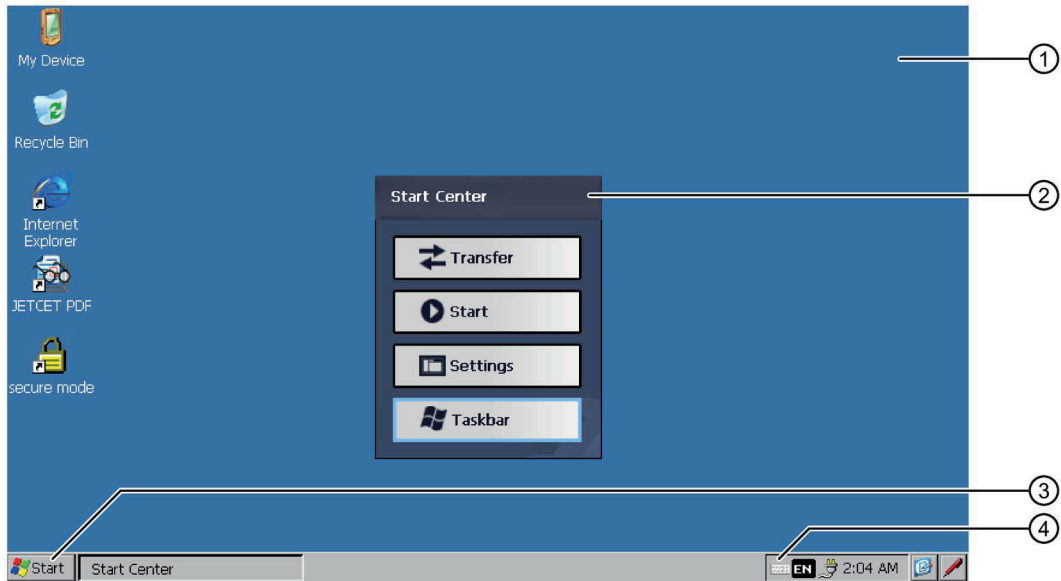

- ① Desktop
- ② Start Center
- ③ Start menu
- ④ Icon for screen keyboard

The Start Center

The Start Center buttons have the following function:

- Transfer – You switch the HMI device to "Transfer" mode.
The transfer is only activated if at least one data channel has been parameterized, see section "Parameterizing Transfer (Page 99)".
- Start – You start the project on the HMI device.
If you do not perform an operation, a project already loaded on the HMI device will start automatically in line with the settings in the Control Panel . If no project is loaded, the Start Center will activate the transfer.
- Settings – You start the Control Panel.
See section "Overview of functions (Page 80)".
- Taskbar – You open the task list and the Start menu.

The Start Center is displayed again if a project on the HMI device has been closed or if it is accessed from the project.







4.3.2 Installed programs

Overview

The following programs are installed on the HMI devices by default:

- Viewers for documents in "PDF", "Excel" and "Word" format
- Media Player
- Internet Explorer

The programs can be found on the desktop or in the Start menu under "Programs". Each of these programs can also be opened from the HMI project.

Program		Icon	Readable file formats
PDF Viewer			PDF
Word Viewer			DOC, RTF
Excel Viewer			XL*
Media Player	Comfort V1/V1.1 devices		WMA, MPEG
	Comfort V2 devices		ASF, WMV, AVI, MP4, WMA, MPA, MP2, MP3, WAV
Internet Explorer			HTML

As of WinCC V14 SP1 (TIA Portal), the programs can be uninstalled or re-installed via ProSave.

Viewer

All viewers share a zoom function. The Excel Viewer also offers the following functions:

- Switch between spreadsheet tabs
- Split the spreadsheet
- Change line height and column width

Media Player

A media player is installed on the HMI device. You can use the Media Player to play video sequences for servicing and maintenance, for example.

Note

The video file names may not contain any special characters except for "_". You can find more information on the Internet in the entry "Videos on Comfort Panels (<https://support.industry.siemens.com/cs/ww/en/view/62101921>)".

Media Player for the HMI device and the Media Player version that can run on a PC differ in terms of functionality.

You can find additional information on the Microsoft website.

Internet Explorer

Internet Explorer for the HMI device and the Internet Explorer version which can run on a PC differ in terms of functionality.

Internet Explorer for the HMI device has separate proxy settings that are independent of the settings in the control panel of the HMI device.

You can find additional information about the Internet Explorer at the Microsoft website.

See also

Setting the proxy server (Page 114)

4.3.3 Security mode

4.3.3.1 Overview

You can protect the desktop icons, the taskbar and the "Settings" and "Taskbar" buttons in the Start Center from unauthorized access. Security mode prevents unauthorized access.

Security mode can be activated if you have assigned a password as described in the section "Changing the password protection (Page 96)". If the password is not entered, only the "Transfer" and "Start" buttons can be operated.

NOTICE
Keep password safe
If the password is no longer available, you have no access to the Control Panel and the taskbar. Secure the password against loss.

4.3.3.2 Operating the HMI device in password-protected safety mode

If security mode has been activated, only the "Transfer" and "Start" buttons can be operated without a password. If you wish to deactivate security mode, you need to delete the password as described in section "Changing the password protection (Page 96)".

Requirement

- A password has been assigned as described in section "Changing the password protection (Page 96)".
- The security mode is displayed, similar to the figure below:

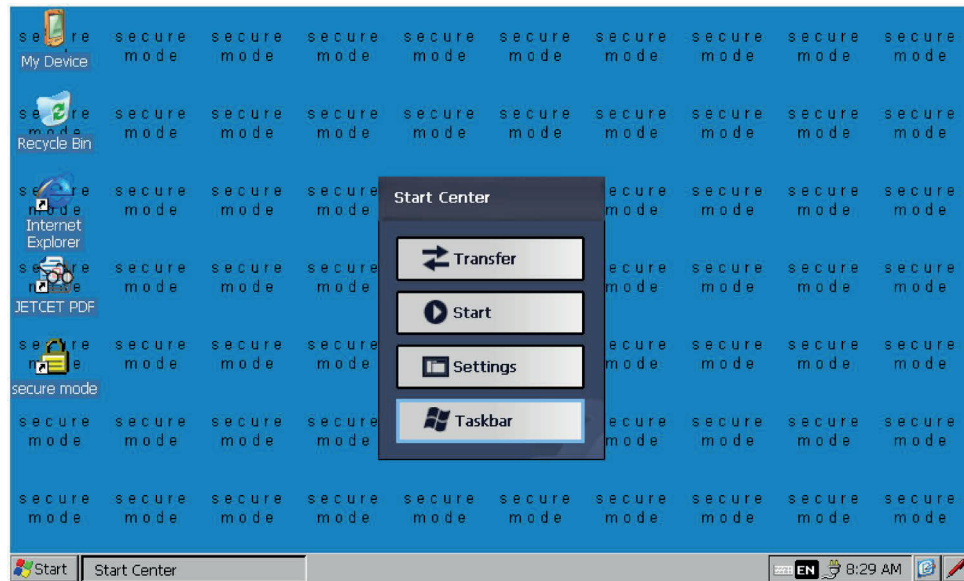

Procedure

1. Operate a password-protected desktop icon, the taskbar or the "Settings" or "Taskbar" button in the Start Center.

The following dialog appears:

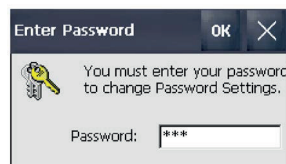

2. Enter the required password.
3. Confirm your entry with "OK".

The dialog will close and the selected operator control open.

4.3.4 Control Panel

4.3.4.1 Opening the settings

The Control Panel can be opened as follows:

- With the "Settings" button in the Start Center.
- In the Start menu via "Settings > Control Panel"



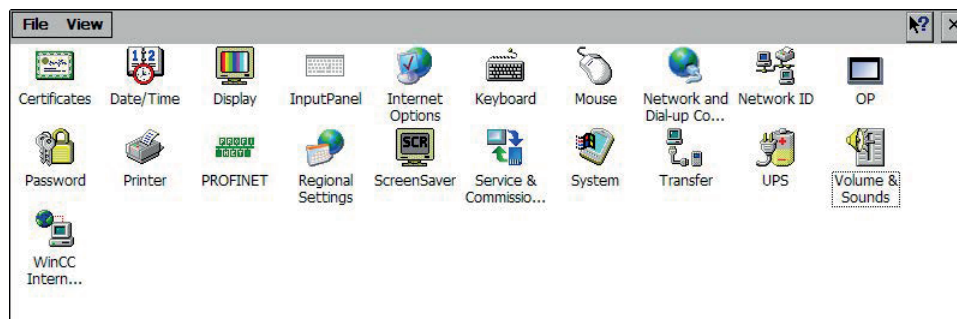





The figure below shows the open Control Panel using the example of an HMI device with 7" display size.















For an HMI device with 4" diagonal display, the label of the icon for the sound settings is "Sounds" instead of "Volume & Sounds".

4.3.4.2 Overview of functions

The table below shows the icons of the Control Panel and provides links to the corresponding function descriptions in the appropriate sections.

Icon	Functional description
	Importing, displaying and deleting certificates (Page 117)
	Setting the date and time (Page 94)
	Changing display brightness (Page 85)
	Change screen orientation (Page 86)
	Configuring the screen keyboard (Page 87)
	Changing general settings (Page 113)
	Setting the proxy server (Page 114)
	Changing Internet security settings (Page 115)
	Activating encryption protocols (Page 116)
	Setting the character repeat rate of the screen keyboard (Page 89)
	Setting the double-click (Page 90)
	Entering the IP address and name server (Page 125)

Icon	Functional description
	Specifying the logon data (Page 129)
	Backing up registry information and temporary data (Page 106)
	Displaying information about the Comfort Panel (Page 109)
	Restarting the HMI device (Page 92)
	Calibrating the touch screen (Page 91)
	Activating memory management (Page 104)
	Activate/deactivate retentivity of the alarm buffer on the HMI device (Page 105) ¹
	Changing the password protection (Page 96)
	Changing the print options (Page 107)
	Enabling NTP (Page 121)
	Enabling PROFINET (Page 119)
	Regional and language settings (Page 94)
	Setting the screen saver (Page 97)
	Saving to external storage medium – backup (Page 137)
	Restoring from external storage medium – Restore (Page 139)
	Updating the operating system (Page 141)
	Load project from external storage medium (Page 144) ²
	Using automatic backup (Page 148)
	Editing IP addresses and communication connections (Page 152)
	Setting volume and sound (Page 110)
	Displaying general system properties (Page 108)
	Displaying the memory distribution (Page 102)
	Specifying the computer name of the HMI device (Page 124)
	Parameterizing Transfer (Page 99)
	Setting the project storage location and start delay (Page 103)
	State of the uninterruptible power supply (Page 160)
	Setting the uninterruptible power supply (Page 158)
	Configuring e-mail (Page 130)
	Configuring Telnet for remote control (Page 131)
	Configure Sm@rt Server (Page 133)
	Configure Web Server (Page 134)

¹ Available in connection with an HMI device image that is compatible with WinCC (TIA Portal) V15.1 or higher.

² Available in connection with an HMI device image that is compatible with WinCC (TIA Portal) V14 or higher.



4.3.4.3 Operating the Control Panel

You can operate the Control Panel using the touch screen. The following steps give a general description of how to operate a function.

Requirement

- The current project has been closed.
- The Start Center is displayed.

Procedure

1. Open the Control Panel using the "Settings" button.
2. Double-click an icon. The corresponding dialog is displayed.
3. Select a tab.
4. Make the desired settings. When you navigate to an entry field, the screen keyboard opens.
5. Your settings are applied with the  button.
To cancel the entry, press the  button. The dialog closes.
6. To close the Control Panel, use the  button.
The Start Center is displayed.

4.3.4.4 Display types for the screen keyboard

The screen keyboard is used for entering alphanumeric, numeric and special characters. As soon as you touch a text box, a numeric or alphanumeric screen keyboard is displayed, depending on the type of the text box.

You can also open the screen keyboard by selecting the icon in the status bar. The icon is shown in the figure in section "Overview of functions (Page 80)".

The procedure for setting the screen keyboard is described in the section "Configuring the screen keyboard (Page 87)".

Representation types for the screen keyboard

You can toggle the screen keyboard display as follows.

Alphanumerical screen keyboard

The alphanumerical screen keyboard has the following levels.

- Normal level
 - HMI device with 4" display



- HMI device with 7" display diagonal or larger

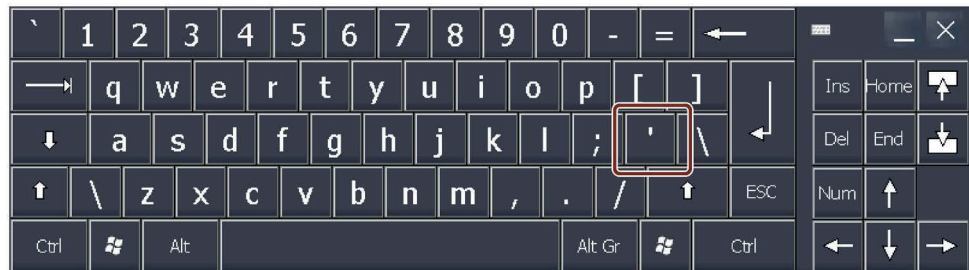

Note

The ' character on the keyboard is only displayed when followed by a space. If the ' character is followed by a letter, then the result will be an accent, such as "á".

- Shift level
 - The shift level has uppercase letters and other special characters.
- The alphanumeric keyboard is always displayed after a restart.

Numerical screen keyboard

By pressing the "Num" button, you can switch between the numerical and alphanumerical screen keyboard.







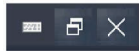



Reduced screen keyboard





You activate the reduced screen keyboard with the  key. The minimized screen keyboard is displayed as follows:



Changing the display of the screen keyboard

Key	Function
	Switching between the numerical and alphanumerical keyboard
	Switching between the normal level and Shift level of the alphanumerical screen keyboard
	Switchover to special characters
	Switching from full display to reduced display
	Switching from reduced display to full display
	Closing of reduced display of the screen keyboard
	Brief touch: Hide screen keyboard Long touch and move at the same time: Move the screen keyboard
	Scaling the screen keyboard. Only available for devices as of a display size of 7" and when the "Show Resize button" option is activated, see section "Configuring the screen keyboard (Page 87)".
	Touch twice: The taskbar opens

Entering data

Key	Function
	Delete character left of cursor
	Delete character right of cursor
	Confirm input
	Cancel input

4.3.5 Configuring operation

4.3.5.1 Changing display brightness

You can use this function to change the brightness of the display by changing the intensity of the backlighting. The intensity of the backlighting can be adjusted with a slider or with the "Reduce brightness" and "Increase brightness" keys.

NOTICE

Reducing backlighting

The brightness of the backlighting decreases with increasing service life. To avoid shortening the service life of the backlighting unnecessarily, set a reduction of the backlighting.

Requirement

The Control Panel is open.

Procedure



1. Open the "Display Properties" dialog using the "Display" icon.

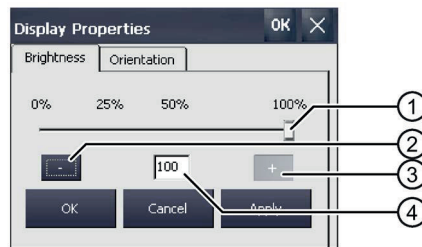

- ① Slider
 - ② Reduce brightness
 - ③ Increase brightness
 - ④ Indicates the set value
2. To increase the brightness, press "+".
The brightness changes by 5% each time you press the key. Maximum possible value: 100%
 3. To reduce the brightness, press "-".
Smallest value that can be set: 25%
 4. To check the setting, press "Apply".
The set brightness value is applied.
 5. Confirm your entry with "OK".
The dialog closes.

The brightness of the display has been changed.

4.3.5.2 Change screen orientation

You use this function to change the screen orientation of a touch HMI device.

Note

Project is deleted when the screen orientation is changed

If you change the screen orientation and a project is located on the HMI device, the project will be deleted when the screen orientation is changed on the HMI device.

The screen orientation of the device must match the screen orientation of the project that is on the HMI device.

Set the screen orientation of the device to match the screen orientation of the project before you transfer the project to the HMI device.

Requirement

The Control Panel is open.

Procedure



1. Open the "Display Properties" dialog using the "Display" icon.
2. Change to the "Orientation" tab.

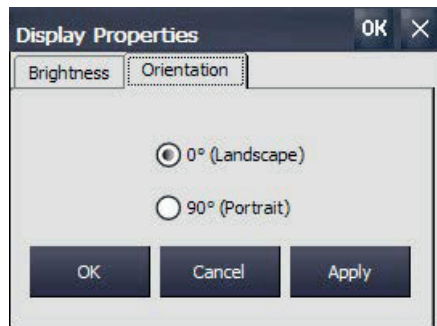

3. If you mount your HMI device horizontally, select the "Landscape" option.
4. If you mount your HMI device vertically, select the "Portrait" option.
5. Confirm the setting with "Apply" or "OK".
The "ATTENTION" dialog informs you that all project data on the HMI device will be deleted when the screen orientation is changed.
6. To change the screen orientation, confirm with "Yes". To cancel, select "No".
If you press "Yes", the screen orientation will be changed.

After the screen orientation change, the HMI device restarts and changes automatically to "Transfer" mode because there is no longer a project on the HMI device.

4.3.5.3 Configuring the screen keyboard

You can use this function to change the size and the position of the screen keyboard.

Requirement

The Control Panel is open.

Procedure



1. Open the "Siemens HMI Input Panel" dialog using the "Input Panel" icon.

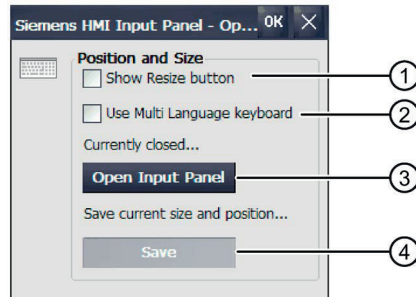

- ① Check box for displaying the "Resize"  button in the screen keyboard, not with 4" devices
- ② Check box for configuring the multilingual screen keyboard, available with an HMI device image that is compatible with WinCC (TIA Portal) V16 or higher. Not with 4" devices.
- ③ Button for opening the screen keyboard
- ④ Button for saving the current position and size of the screen keyboard

2. If you want a scalable screen keyboard on a HMI device with display diagonal $\geq 7"$, select the check box "Show Resize Button".

If "Show Resize Button" is activated, the "Resize"  button is displayed in the open screen keyboard.

3. To open the settings for a multilingual layout of the screen keyboard on an HMI device with display diagonal $\geq 7"$, select the check box "Use Multi Language keyboard". The additional area "Keyboard Layouts" is displayed.

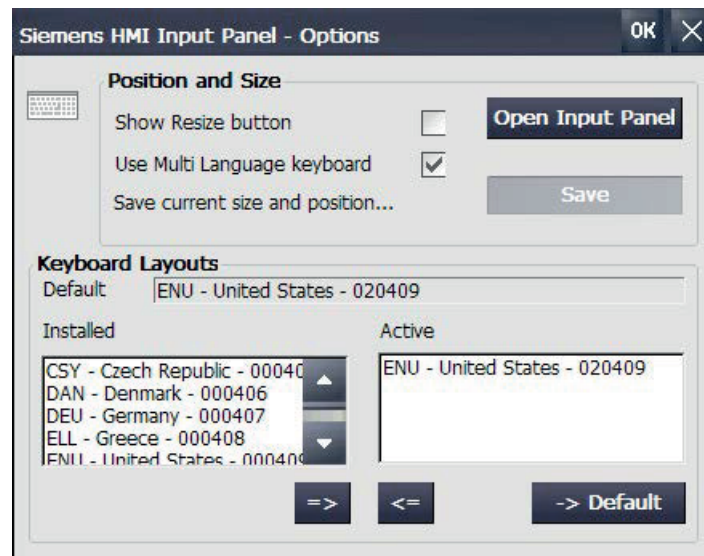

The "Default" display field shows the keyboard layout that is used as default keyboard layout when the HMI device is started.

The "Installed" list contains all keyboard layouts available on the HMI device.



The "Active" list contains all keyboard layouts that can be switched via the screen keyboard.

- With the "=>" button, you add a keyboard layout to the "Active" list.
- With the "<=" button, you remove a keyboard layout from the "Active" list.
- With the "-> Default" button, you define a keyboard layout from the "Active" list as default keyboard layout.

As soon as there is more than one keyboard layout in the "Active" list, another button for the language selection is displayed in the screen keyboard. The following figure shows an example of the English keyboard layout.



With this button, you switch successively between the keyboard layouts entered in the "Active" list.

4. If you want to check the settings, open the screen keyboard with the "Open Input Panel" button. Set the required size and position of the screen keyboard using the following buttons of the screen keyboard:
 - Position the screen keyboard by pressing the "Input Panel"  button and moving it.
 - HMI devices ≥ 7 :
 - Scale the screen keyboard by pressing the "Resize"  button and moving it.
 - Switch the keyboard layout by clicking the button for language selection.
5. Use the "Save" button to save the current settings for size and position of the screen keyboard.
6. Confirm your entries with "OK".

The dialog closes.

The screen keyboard settings have been modified.

4.3.5.4 Setting the character repeat rate of the screen keyboard

You can use this function to set the character repeat and repeat delay for the screen keyboard.

Requirement

The Control Panel is open.

Procedure



1. Open the "Keyboard Properties" dialog using the "Keyboard" icon.

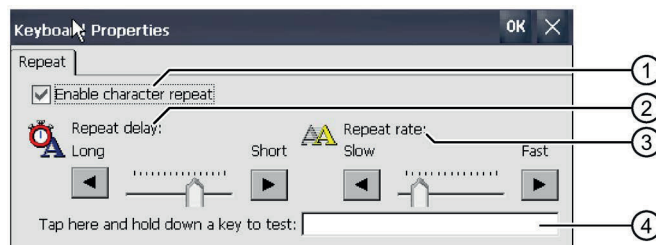

- ① Check box for selecting the character repeat
- ② Slider control and buttons for the delay time before character repeat
- ③ Slider control and buttons for the rate of the character repeat
- ④ Test box

2. If you want to enable character repetition, select the "Enable character repeat" check box.
3. To change the delay, press a button or the slider in the "Repeat delay" group. Moving the slider to the right reduces the delay. Moving it to the left extends the delay time.
4. To change the repeat rate, press a button or the slider in the "Repeat rate" group. Moving the slider to the right speeds up the repeat rate. Moving to the left will slow down the repeat rate.
5. Check the settings for the touch control by touching the test field. The screen keyboard is displayed.
6. Move the screen keyboard as needed.
7. Press a key for a character and keep the key pressed. Check that character repetition occurs and the rate of the character repetition in the test field.
8. If the settings are not ideal, correct them.
9. Confirm your entries with "OK". The dialog closes.

The character repetition and delay are set.

4.3.5.5 Setting the double-click

You start applications in the Control Panel and in the operating system with a double-click. A double-click corresponds to two brief touches.

In the "Mouse Properties" dialog, make the following settings for operation with the touch screen:

- Interval between two touch contacts on the touch screen
- Interval between the two clicks of a double-click

Requirement

The Control Panel is open.

Procedure



1. Open the "Mouse Properties" dialog using the "Mouse" icon.

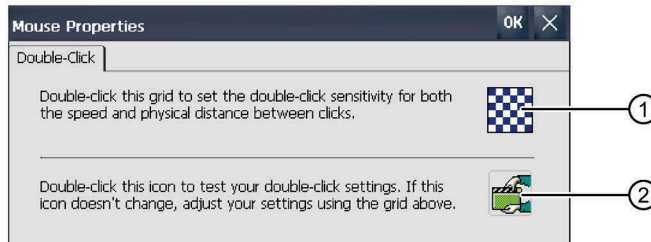

- ① "Checkered pattern" icon
- ② "Test" icon

2. Double-click the "Checkered pattern" icon.
After the double-click, the colors in the pattern are inverted. White boxes become gray. The timeframe for the double-click is saved.



3. Check the double-click: Press the "Test" icon twice in succession. If the double-click is recognized, the "Test" icon is displayed as follows:



4. Repeat steps 2 and 3 as necessary until the settings are okay.
5. Confirm your entry with "OK".
The dialog closes.

The double-click adjustment is completed.

4.3.5.6 Calibrating the touch screen

Parallax may occur on the touch screen depending on the mounting position and perspective. To prevent any resulting operating errors, you may need to calibrate the touch screen.

Requirement

- A touch pen
- The Control Panel is open.

Procedure



1. Open the "OP Properties" dialog using the "OP" icon.
2. Change to the "Touch" tab.

Comfort Panels V1/V1.1



Comfort Panels V2

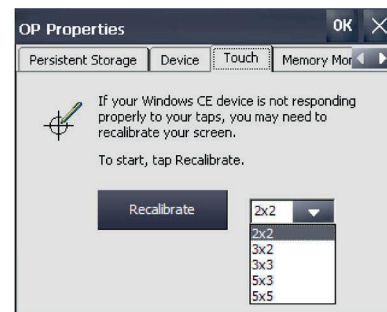

3. Comfort V2 devices: Select the number of calibration points. Press the "Recalibrate" button. The following dialog is displayed:

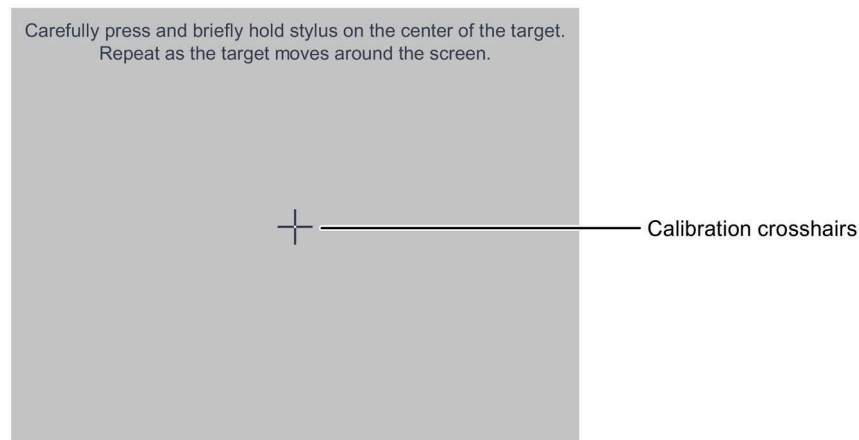

4. Touch the center of the calibration cross until it is shown at the next position. The calibration crosshairs are then displayed at four more positions.

Once you have touched the calibration crosshairs for all positions, the following dialog appears:

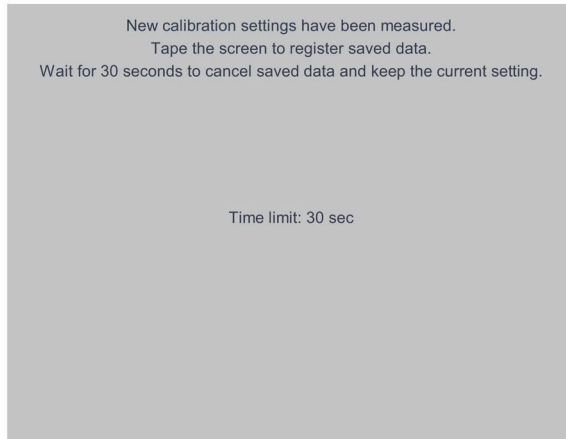

5. Touch the touch screen within the indicated time. The calibration will be saved. The "Touch" tab is displayed once again in the "OP Properties" dialog. If you do not touch the touch screen within the time shown, your original setting will be retained.
6. Close the "OP Properties" dialog with "OK".
The touch screen of the HMI device is calibrated.

4.3.5.7 Restarting the HMI device

You need to perform a restart in the following situations:

- You have enabled or disabled the PROFINET IO direct keys, see section "Enabling NTP (Page 121)".
- You have changed the time zone setting or activated daylight saving time; see section "Setting the date and time (Page 94)".
- You have changed the settings for the screensaver, see section "Setting the screen saver (Page 97)".
- You have changed the retentivity behavior of the alarm buffer, see section "Activate/deactivate retentivity of the alarm buffer on the HMI device (Page 105)".

NOTICE

Data loss

All volatile data is lost with a restart.

Make sure that no project is running on the HMI device and no data is being written to the flash memory.

Requirement

- If you want to restore the factory settings:
The HMI device is connected in accordance with "Connecting the configuration PC (Page 51)".

Procedure



1. Open the "OP Properties" dialog using the "OP" icon.
2. Change to the "Device" tab.



3. Click the "Reboot" button.
The following dialog appears:

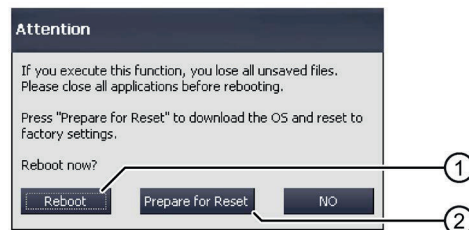

- ① Button for restart
 - ② Button for restoring factory settings and subsequent restart
4. Press one of the following buttons:
 - "Reboot": Restart the HMI device immediately.
 - "Prepare for Reset": Reset the HMI device to factory settings.

Note

Press "Prepare for Reset" to delete the operating system and project data.

Restore the operating system as described in the section "Updating the operating system (Page 141)".

- "No": Do not perform a restart, close the dialog.

4.3.6 General settings

4.3.6.1 Regional and language settings

The date, time and decimal points are displayed differently in different countries. You can adapt the display format to meet the requirements of various regions. The country-specific settings apply to the current project. If the project language is changed, the country-specific settings are also changed.

Requirement

The Control Panel is open.

Procedure



1. Open the "Regional and Language Settings" dialog using the "Regional Settings" icon.

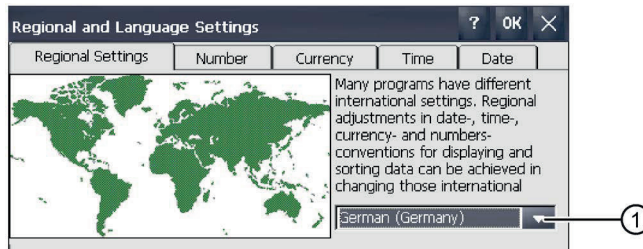

① "Region" selection box

2. Select the required region in the selection box ①.
3. Navigate to the "Number", "Currency", "Time" and "Date" tabs one after the other.
4. Set the required regional settings in the selection field of these tabs.
5. Confirm your entries.
The dialog closes.

The country-specific specifications for the HMI device are now set. "Setting the date and time (Page 94)" describes how to activate daylight saving time.

4.3.6.2 Setting the date and time

You can use this function to set the date and time. The HMI device has an internal buffered clock.

Requirement

The Control Panel is open.

Procedure



1. Open the "Date/Time Properties" dialog using the "Date/Time" icon.

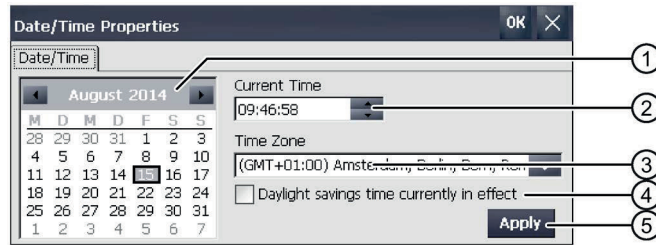

- ① Date selection box
- ② Text box for the time
- ③ Time zone selection box
- ④ Check box for activating and deactivating daylight saving time
- ⑤ Button for applying changes

2. Select the applicable time zone for the HMI device from the "Time Zone" selection box.
3. Press the "Apply" button.
The time of day shown in the "Current Time" field is adjusted correspondingly to the selected time zone.
4. Set the date in the selection box.
5. Set the current time of day in the "Current Time" entry field.
6. Press the "Apply" button.
The entry is applied.

Note

The system does not automatically switch between standard time and daylight saving time.

7. If you want to switch from standard time to daylight saving time, select the "Daylight savings time currently in effect" check box.
With "Apply", the time of day is set one hour ahead.
8. If you want to switch from daylight saving time to standard time, clear the "Daylight savings time currently in effect" check box.
With "Apply", the time of day is set back one hour.
9. Confirm your entries.
The dialog closes.

The settings for the data and time of day have now been changed. The HMI device must be restarted after changes in the following cases:

- You have changed the time zone setting
- You have changed the "Daylight savings time currently in effect" check box setting

See "Restarting the HMI device (Page 92)".

Synchronizing the date and time with the PLC

The date and time of the HMI device can be synchronized with the date and time in the PLC if this has been configured in the project and the control program. Additional information is available here:

"SIMATIC Safety - Configuring and Programming" programming and operating manual (<https://support.industry.siemens.com/cs/ww/en/view/54110126>)

NOTICE
Synchronizing the date and time
If the data and time is not synchronized and time-based reactions are triggered by the HMI device, malfunctions in the PLC may occur.
Synchronize the date and time if time-based reactions are triggered in the PLC.

4.3.6.3 Changing the password protection

You can protect access to the Control Panel with a password. If you configure password protection, "SecureMode" is automatically enabled for the HMI device. "SecureMode" additionally protects the taskbar and the desktop against unauthorized access.

Requirement

The Control Panel is open.

Note

Password not available

If the password is no longer available, the following operator controls are no longer enabled:

- Control Panel
- Taskbar
- Desktop

All data on the HMI device is deleted when you update the operating system!

Therefore, secure the password against loss.

Procedure



1. Open the "Password Properties" dialog using the "Password" icon.

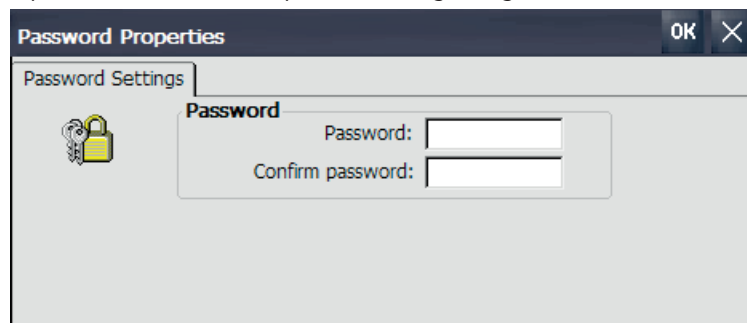

2. Enter the password under "Password".
3. Repeat the password under "Confirm password".
4. Confirm your entry with "OK".

Result

The "secure mode" label is displayed on the desktop:

If you attempt to operate the Control Panel, taskbar or desktop, you are prompted for a password.

Removing password protection and "SecureMode"

To cancel password protection and "SecureMode", delete the entries under "Password" and "Confirm password" in the "Password Properties" dialog.

See also

Operating the HMI device in password-protected safety mode (Page 79)

4.3.6.4 Setting the screen saver

You can set the following time intervals in the Control Panel:

- Automatic activation of the screen saver
- Automatic reduction in the display backlighting

The HMI device exhibits the following behavior based on the settings:

- The screen saver is automatically activated if the HMI device is not operated within the specified period of time.
- Touching the touch screen switches off the screen saver. If you touch a button at the same time, the function assigned to the button is not executed. In addition, the reduction of the backlighting according to the settings of the screen saver is canceled.

NOTICE

Activating the screen saver

Display content that is not changed for a long period can remain dimly visible in the background for a long time. This effect is reversible when you use a screen saver with moving image. Therefore, activate the screen saver of the type "Standard (Flying Windows)".

Requirement

The Control Panel is open.

Procedure



1. Open the "Screensaver" dialog using the "ScreenSaver" icon.

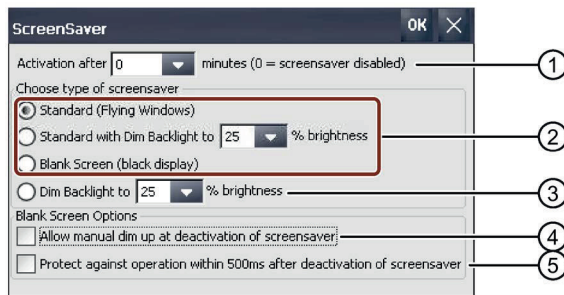

- ① Period of time in minutes before the screen saver is activated
 - ② Type of screen saver
 - ③ Reduced backlighting to a specified value
 - ④ Allow dimming when deactivating the "Blank Screen" screen saver
 - ⑤ Short-term operation lock after deactivating the "Blank Screen" screen saver
2. Enter the number of minutes after which the screen saver is to be activated. The minimum setting is 1 minute and the maximum setting is 360 minutes. Entering "0" disables the screen saver.
3. Select the type of screen saver:
 - Use the "Standard" option to enable the default screensaver.
 - Using the option "Standard with Dim Backlight" you activate the Windows standard screensaver and reduce the backlight to a value between 25% and 90%. If you enter a value outside the range of 25 to 90%, a message will appear and the value is reset to 25%.
 - Use the option "Blank Screen" to activate the disabling of the backlighting of the device.
4. Using the option "Dim Backlight to" you reduce the backlight to a value between 25% and 90%, without activating a screen saver. If you enter a value outside the range of 25 to 90%, a message will appear and the value is reset to 25%.

5. The "Allow manual dim up at deactivation of screensaver" for the "Blank Screen" screen saver works as follows:
 - If the option is activated, you can dim the display brightness on deactivation of the screen saver. The brightness is increased as long as you keep pressing the touch screen.
 - If the option is deactivated, the brightness is increased to the value that was set prior to activation of the screen saver when you touch the touch screen.
6. If you want to delay touch operation for a brief time following deactivation of the "Blank Screen" screensaver, for example, to prevent incorrect operator inputs in connection with option ④, select the "Protect against operation within 500 ms after deactivation of screensaver" check box.
7. Confirm your entries.
The dialog closes.

The screen saver for the HMI device has now been set. You will need to restart the HMI device after the screen saver has been activated. The screen saver is then enabled.

See also

Operating the HMI device in password-protected safety mode (Page 79)

4.3.6.5 Parameterizing Transfer

A project can only be transferred from the configuration PC to the HMI device when at least one data channel is configured and enabled on the HMI device. Follow the procedure below to configure transfer mode.

If you block all data channels, the HMI device is protected against unintentional overwriting of the project data and HMI device image.

Requirement

The Control Panel is open.

Note

If you change the transfer settings while a transfer is in progress and want to confirm with "OK", an error message is displayed.

Procedure



1. Open the "Transfer Settings" dialog using the "Transfer" icon.

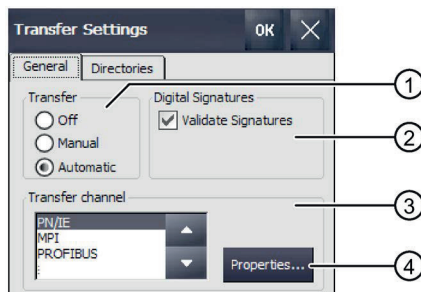

- ① Transfer group
- ② Digital signatures group
- ③ Transfer channel group
- ④ Button for parameter assignment of the transfer channel properties

2. Change to the "General" tab.
3. In the "Transfer" group, select whether you want to enable or disable "Transfer" mode. Select one of the following options:
 - Off – Transfer is not possible
 - Manual – Manual transfer
If you want to initiate a transfer, close the active project and press the "Transfer" button in the Start Center.
 - Automatic – Automatic transfer
A transfer can be remotely triggered from a configuration PC or a programming device. The running project is closed immediately in this case and the transfer is started.

! WARNING

Unintended reactions during automatic transfer

When an automatic transfer starts and the running project is closed immediately, this could cause unintentional reactions to be triggered in the plant. This can result in personal injury or material damage.

Take the following measures to prevent undesired reactions in the plant:

- Select the "Off" or "Manual" setting for "Transfer" after the commissioning phase.
- Assign a password in the Control Panel to restrict access to the transfer settings by unauthorized persons.

4. "Digital signatures" group:

To select the check of the signature during transfer of an HMI device image, select the "Validate Signatures" check box. This function is available in connection with an HMI device image that is compatible with WinCC (TIA Portal) V14 or higher. Image signatures are checked starting with V14. If you transfer an image that is compatible with a version before V14, an error message is displayed.

To transfer an unsigned image that is compatible with a version before V14, clear the "Validate Signatures" check box.

5. Select the required data channel in the "Transfer channel" group.

– PN/IE

The transfer takes place over PROFINET or Industrial Ethernet. An HMI device can communicate as follows:

– With a PLC directly via routing

– Over a switch or over a router in the local network

– MPI

– PROFIBUS

– USB device (with Comfort V1/V1.1 devices)

– Ethernet

6. To call up the addressing of the HMI device, press "Properties".

The necessary inputs can be found in the following sections, depending on the data channel:

– PN/IE: see section "Entering the IP address and name server (Page 125)".

– MPI or PROFIBUS: see section "Changing MPI/PROFIBUS DP settings (Page 128)".

7. Confirm your entries with "OK".

The dialog closes.

The data channel for transfer is configured.

See also

Load project from external storage medium (Page 144)

4.3.6.6 Memory management

Displaying the memory distribution

This function displays the size of the flash memory and its archived data and program data allocation.

Requirement

The Control Panel is open.

Procedure



1. Open the "System Properties" dialog using the "System" icon.
2. Change to the "Memory" tab.

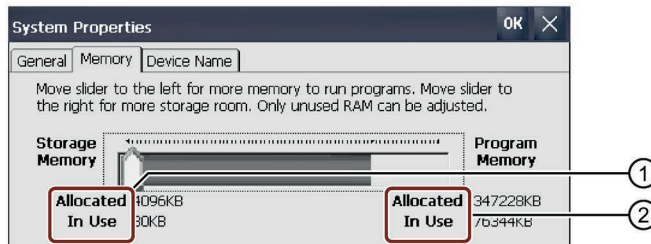

- ① Cache memory, available and used
- ② RAM, available and used

NOTICE

Malfunction

If you change the allocation of the memory, malfunctions may occur.

Do not change the memory allocation in the "Memory" tab unless the message "Insufficient memory" is displayed.

Additional information is available in the information system of the TIA Portal.

Setting the project storage location and start delay

There are various storage locations available for storing the compressed source file of your project, for example, the external memory card or a network drive. This section describes how to set the location and configure the delay time for the project start.

Requirement

The Control Panel is open.

Procedure



1. Open the "Transfer Settings" dialog using the "Transfer" icon.
2. Change to the "Directories" tab.

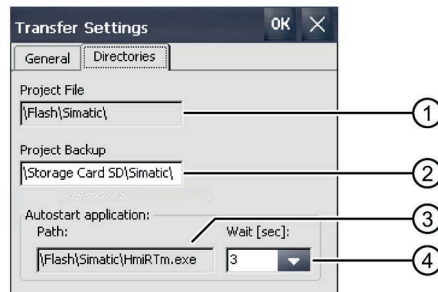

- ① Storage location for project file, cannot be set
- ② Directory where the compressed source file of your project is saved
- ③ Storage location and initialization file for process operation, cannot be set
- ④ Delay time for project start

3. Select a memory location from the "Project Backup" text box.
The storage location can be a storage medium or the local network. During the next backup process, the project's source file is stored in the specified location.
4. Select the desired delay time for project start from the "Wait [sec]" selection box.
The delay time sets how long the Start Center is displayed before the project starts. Permissible values are 1, 3, 5 and 10 seconds, for HMI device image versions $\geq V14$ SP1 additionally: 60 seconds.
You can also select:
 - 0 seconds
The project starts immediately. The Start Center is **not** displayed.
 - Forever
The project does not start. The Start Center is displayed permanently.

Note

For the Start Center to be accessed after the project starts, an operating element must be configured in the project with the "Close project" function.

5. Confirm your entries with "OK".
The dialog closes.

The storage location and delay time for the HMI device are now set.

Activating memory management

Note

Memory management

If you do not activate memory management, undefined states can occur during the runtime of the project.

Requirement

The Control Panel is open.

Procedure

Proceed as follows:

1. Open the "OP Properties" dialog using the "OP" icon.
2. Change to the "Memory Monitoring" tab.

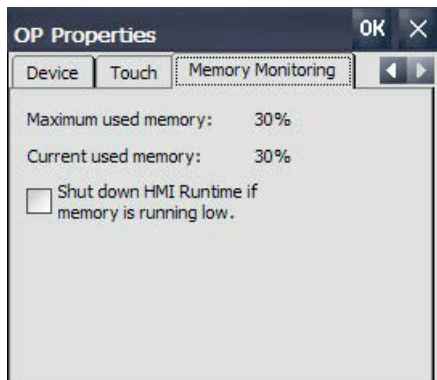

3. If you want to enable memory management, select "Shut down HMI Runtime...".
4. Confirm your entries with "OK".

Result

Memory management is activated. An open project is closed under these circumstances:

- Insufficient RAM
- RAM needs to be reorganized

An alarm is then triggered on the HMI device. Restart the project on the HMI device.

Activate/deactivate retentivity of the alarm buffer on the HMI device

This function is available in connection with an HMI device image that is compatible with WinCC (TIA Portal) V15.1 or higher.

You can use this function to activate or deactivate the retentive alarm buffer. The default setting is "activated".

When the retentivity of the alarm buffer is activated, the retentive alarm data is backed up every two seconds to the internal flash memory of the HMI device. With a high number of alarms, the internal flash memory is subject to an equally high number of read and write cycles.

If the retentivity of the alarm buffer is deactivated, the alarm buffer is emptied and the retentive alarm data is no longer backed up to the internal flash memory. This means the internal flash memory is used less with a high number of alarms.

Note

Backing up data before deactivating the retentivity

When you deactivate the retentivity of the alarm buffer and still need the data in the alarm buffer, back up this data before deactivating the retentivity in a log.

Note

Changing the retentivity behavior using the configuration

As of WinCC (TIA Portal) V15.1 you can also change the retentivity behavior with the "Persistent alarm buffer" function under "Runtime settings > Alarms > General". Default setting in the configuration is "activated". For the project transfer, the setting is applied from the configuration in the Control Panel. If you change the setting in the Control Panel after the project transfer, the changed setting is retained until the next project transfer.

Requirement

The Control Panel is open.

Procedure

Proceed as follows:

1. Open the "OP Properties" dialog using the "OP" icon.
2. Change to the "Message Buffer" tab.

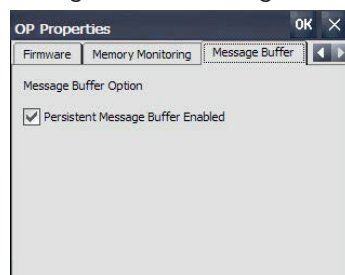

3. You activate or deactivate the retentive message buffer with the "Persistent Message Buffer Enabled..." option, default setting is "activated".

4. Confirm your entries with "OK".
5. Restart the HMI device, see section "Restarting the HMI device (Page 92)".

4.3.6.7 Backing up registry information and temporary data

You can install and uninstall your own software on and from the HMI device. You need to back up the registry settings to flash memory after installation or removal.

You can also save the data in the memory buffer to flash memory.

Requirement

The Control Panel is open.

Procedure



1. Open the "OP Properties" dialog using the "OP" icon.

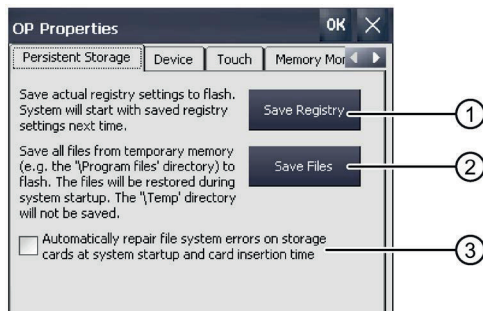

- ① Button for saving registry information
 - ② Button for saving temporary files
 - ③ Automatically repairs file system errors on plug-in storage media during HMI device startup and when a storage medium is inserted.
2. To back up the current registry entries, press the "Save Registry" button. The current registry entries will be backed up in the flash memory. The HMI device loads the saved registry information the next time it boots.
 3. To back up temporary files, press the "Save Files" button. All files from the temporary memory will be backed up in the flash memory. You can access the files saved under "Start > Documents". These files are written back when the HMI device is started. The "\\Temp" directory is not saved.
 4. If you want file system errors on the memory card to be repaired automatically, select the "Automatically repair file ..." check box. If the check box is cleared, a necessary repair of the file system on memory cards is only performed on request.
 5. Confirm your entries with "OK". The dialog closes.

At the next startup, the HMI device will use the registry entries and temporary files set.

4.3.6.8 Changing the print options

The HMI device can print on network printers. You can print hardcopies and reports on a network printer. Line printing of alarms is not possible on a network printer.

The list of current printers and required settings for HMI devices can be found on the Internet at "Approved printers for SIMATIC HMI Panels

(<https://support.industry.siemens.com/cs/ww/en/view/11376409>)".

Requirement

The Control Panel is open.

Procedure



1. Open the "Printer Properties" dialog using the "Printer" icon.

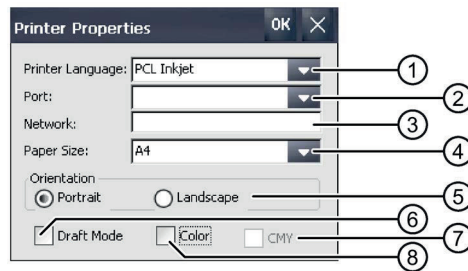

- ① Selection list for the printer
- ② Selection list for the interface
- ③ Network address of the printer
- ④ Drop-down list for printing paper format
- ⑤ "Orientation" group with radio buttons for print orientation
- ⑥ Print quality check box
- ⑦ Check box for color quality, valid only for Brother HL 2700 printer
- ⑧ Color printing check box

2. Select a printer from the "Printer Language" selection list.
3. Select the port for the printer from the "Port" selection list.
4. If you wish to print via the network, enter the printer's network address in the "Network" text box.
5. Select a paper format in the "Paper Size" selection list.
6. Activate a radio button in the "Orientation" group.
 - "Portrait" for printing in Portrait format
 - "Landscape" for printing in Landscape format

7. Select the print quality.
 - Select the "Draft Mode" check box if you wish to print in draft mode.
 - Deactivate the "Draft Mode" check box if you wish to print with higher quality.
8. If the printer selected can print in color and you wish it to do so, select the "Color" check box.
9. If you use a Brother HL 2700 printer, select the "CMY" check box.
This allows you to improve the color quality for the printed pages.
10. Confirm your entries with "OK".
The dialog closes.
The printer is now set as specified.

4.3.6.9 Displaying general system properties

Use this function to display the general system information relating to the operating system, processor and memory. You will need this information when contacting Technical Support (Page 239).

Requirement

The Control Panel is open.

Procedure



- Open the "System Properties" dialog using the "System" icon.
The figure below shows an example for a Comfort V1 device.

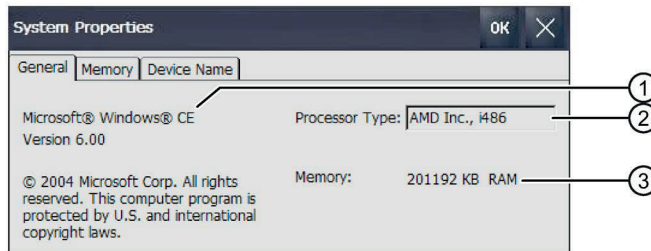

- ① Information on the version and the copyright of the operating system
- ② Processor information
- ③ Information on the size of the RAM

The displayed data relates to the specific device. The processor and memory information may deviate from that for this HMI device.

4.3.6.10 Displaying information about the Comfort Panel

You can use this function to display device-specific information. You will need this information if you contact Technical support (<https://support.industry.siemens.com>).

Requirement

The Control Panel is open.

Procedure



1. Open the "OP Properties" dialog using the "OP" icon.
2. Change to the "Device" tab.

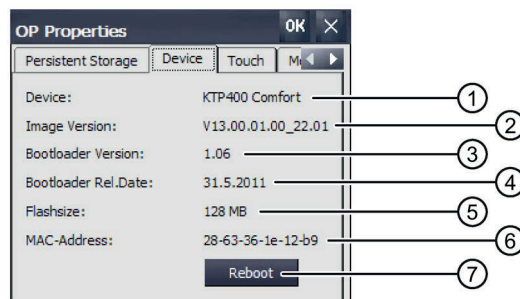

- ① HMI device name
- ② Version of the HMI device image
- ③ Version of the bootloader
- ④ Bootloader release date
- ⑤ Size of the internal flash memory in which the HMI device image and project are stored
- ⑥ MAC address 1 of the HMI device
- ⑦ See "Restarting the HMI device (Page 92)."

Device-specific information is displayed.

Note

The size of the flash memory does not correspond to the available memory for a project, see section "Technical specifications (Page 219)".

4.3.6.11 Setting volume and sound

Volume and acoustic signal of the 4" devices

You can activate an acoustic feedback for keyboard and touch screen operations. An acoustic signal is emitted with each touch or activation of a key.

Requirement

The Control Panel is open.

Note

If you disable each of the settings under "Enable clicks and taps for", no acoustic signals will be output for incorrect operator inputs.

Procedure



Proceed as follows:

1. Open the "Sound" dialog using the "Sound" icon.

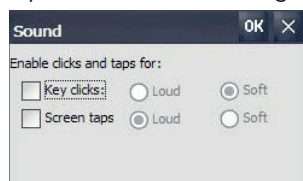

2. To output acoustic signals for operator actions, select the desired options under "Enable clicks and taps for":
 - "Key clicks": Feedback of key operation
 - "Screen taps": Feedback of touch operation
3. Use "Loud" and "Soft" to select between loud and quiet operator feedback.
4. Confirm your entries with "OK".

The properties of acoustic signals are set.

Volume and sound of 7" and larger devices

You can activate an acoustic feedback for keyboard and touch screen operations. A sound is emitted with each touch or activation of a key.

Requirement

The Control Panel is open.

Note

If you deactivate the settings under "Enable sounds for", no more acoustic signals will be emitted during inadvertent operations.

Procedure

Setting volume and enabling sounds

1. Open the "Volume & Sounds Properties" dialog using the "Volume & Sounds" icon.
2. Change to the "Volume" tab.

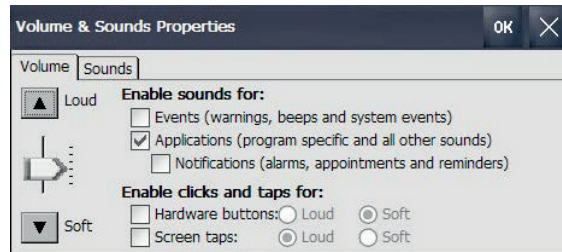



3. To output additional acoustic signals for messages of the HMI device, select the desired options under "Enable sounds for":
 - "Events": Warnings and system events
 - "Applications": Program-specific events
 - "Notifications": Notifications
4. Use the slider or the "Loud" and "Soft" buttons to set the desired volume of the acoustic signals.
5. To output acoustic signals for operator actions, select the desired options under "Enable clicks and taps for":
 - "Hardware buttons": Feedback of key operation
 - "Screen taps": Feedback of touch operation
6. Use "Loud" and "Soft" to select between loud and quiet operator feedback.
7. Confirm your entries with "OK".

Assigning sounds and events

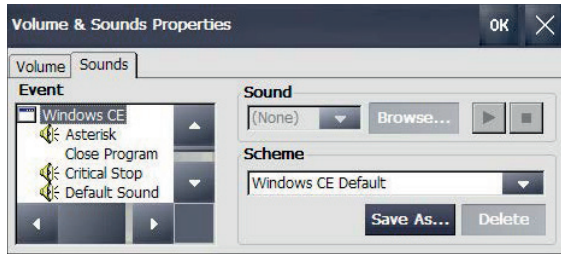
1. Change to the "Sound" tab.



2. Under "Event", select the event to which you want to assign a sound. Events to which a sound is already assigned are marked with a loudspeaker symbol.
3. Select the desired sound for the event under "Sound":
 - Select either a standard sound or use "Browse" to select a "*.WAV" file from the file system.
 - Test the sound with "Play", if required.

 - Stop the output with "Stop", if required.

4. Confirm your entries with "OK".

Sounds and properties of acoustic signals are set.

4.3.7 Changing Internet settings

4.3.7.1 Changing general settings

You can use this function to set the homepage and search engine page for an Internet connection over Internet Explorer.

Requirement

- The Control Panel is open.
- Your system administrator has provided you with the necessary information.

Procedure



1. Open the "Internet Options" dialog using the "Internet Options" icon.

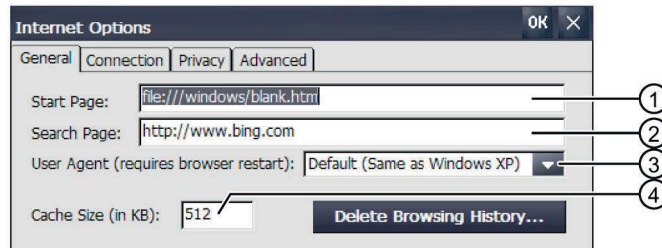

- ① Internet browser homepage
- ② Search engine homepage
- ③ Homepage of your browser
- ④ Memory capacity

2. Enter the homepage for the Internet browser in the "Start Page" text box.
3. Enter the address of the default search engine in the "Search Page" text box.
4. If you want to use your own browser, enter its homepage in the "User Agent" entry field. After making this entry, the browser must be started.
5. Enter the desired cache size in the "Cache Size" entry field.
6. To delete the browser history, press "Delete Browsing History".
7. Confirm your entries with "OK".
The dialog closes.

The general parameters for the Internet browser have been set. The settings take effect the next time you start the Internet browser.

4.3.7.2 Setting the proxy server

Use this function to configure the type of Internet access.

Requirement

- The Control Panel is open.
- Your system administrator has provided you with the necessary information.

Procedure



1. Open the "Internet Options" dialog using the "Internet Options" icon.
2. Change to the "Connection" tab.

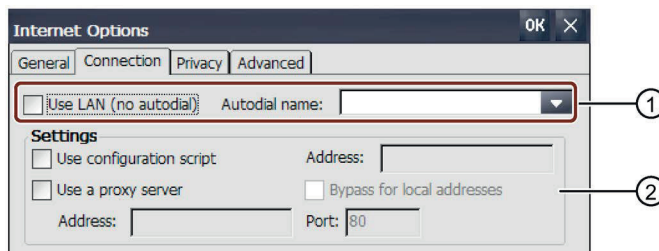

- ① LAN dial-up
- ② LAN configuration

3. If you want to use LAN without automatic dial-up, select the "Use LAN (no autodial)" check box.
4. If you want to use LAN with automatic dial-up, clear the "Use LAN (no autodial)" check box and select the required name in the "Autodial name" list box.
5. If you are using a configuration script, select the "Use configuration script" check box in the "Settings" group.
Enter the address of the script.
6. If you are using a proxy server, select the "Use a proxy server" checkbox.
Specify the address and port of the proxy server. Only the start of the addresses is required. Separate the addresses with a semicolon.
7. To use a local address, select the "Bypass for local addresses" check box.
8. Confirm your entries with "OK".
The dialog closes.

The parameters for the LAN connection have been assigned.

4.3.7.3 Changing Internet security settings

A cookie typically contains information about websites visited; the Internet browser saves this information automatically when you surf the Internet. If you want to restrict the storing of cookies, you can do so on a tab of the "Internet Options" dialog.

Requirement

- The Control Panel is open.
- Your system administrator has provided you with the necessary information.

Procedure



1. Open the "Internet Options" dialog using the "Internet Options" icon.
2. Change to the "Privacy" tab.

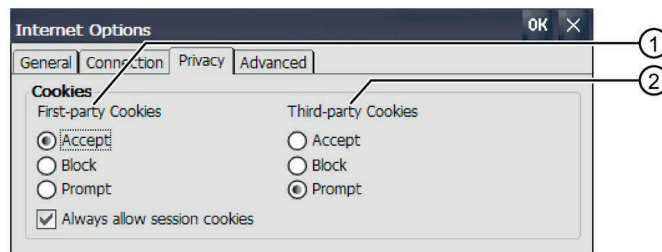

- ① First-party Cookies
- ② Third-party Cookies

3. Select the behavior for handling cookies.
 - "Accept": Cookies will be stored automatically.
 - "Block": Cookies will not be stored.
 - "Prompt": Cookies will be stored after a prompt.
4. If you want to allow cookies that apply only during a single session, select "Always allow session cookies".
5. Confirm your entries with "OK".

The properties for processing cookies are set.

4.3.7.4 Activating encryption protocols

Data can be encrypted for greater data transmission security. Common encryption protocols include SSL and TLS. TLS is a more advanced encryption protocol than SSL. You can activate or deactivate the usage of encryption protocols.

Read "General safety instructions (Page 27)".

Requirement

- The Control Panel is open.
- Your system administrator has provided you with the necessary information.

Procedure



1. Open the "Internet Options" dialog using the "Internet Options" icon.
2. Change to the "Advanced" tab.

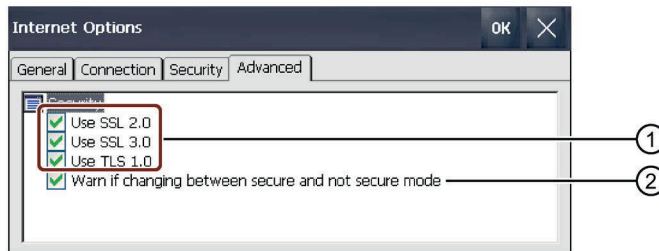

- ① Available encryption protocols
 - ② Warning upon switch between secure and non-secure data transmission
3. Activate the required encryption protocols.

Note

If no encryption protocol is activated, data is sent over the Internet in non-secure mode.

4. If you want to be warned that you are switching between secure and non-secure data transmission, select the "Warn if changing between ..." check box.
5. Confirm your entries with "OK".
The dialog closes.

The encryption protocols are set.

4.3.7.5 Importing, displaying and deleting certificates

You can use this function to import, display and delete certificates. The certificates are proof of an IT qualification and the categories are as follows:

- Certificates that you can trust
- Own certificates
- Certificates from other known providers

A digital certificate consists of structured data, which confirms ownership and other properties of a public key.

Read "General safety instructions (Page 27)".

Requirement

- The Control Panel is open.
- A USB stick with one or more valid certificates is prepared.
- Your system administrator has provided you with the necessary information.

Procedure



1. Open the "Certificates" dialog using the "Certificates" icon.

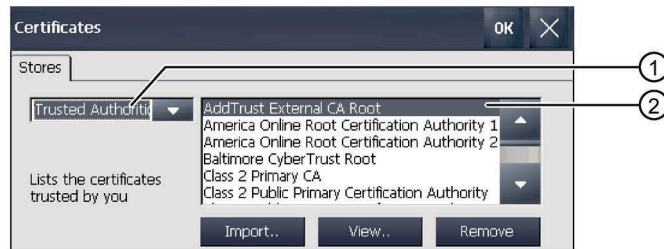

- ① List of trusted certificates
- ② Certificate name

2. Insert the USB stick into the USB port.
3. Select the type of certificate from the selection box:
 - "Trusted Authorities" for trustworthy certificates
 - "My Certificates" for your own certificates
 - "Other Certificates" for other certificates

4. Use the "Import.." button to specify the source from which the certificate will be imported. The following dialog appears:

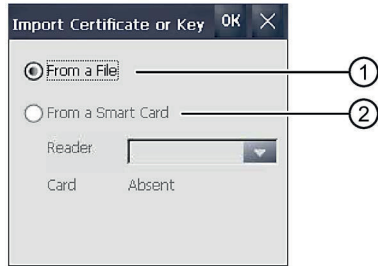

- ① Import from a file
- ② Import from a smart card reader

5. Select "From a File" or "From a Smart Card" if a smart card reader is connected to the HMI device.

Note

The Smart Card reader is not an approved source for importing certificates for the HMI device.

6. Close the dialog with "OK".
7. In the subsequent file selection dialog, select the desired certificate on the USB flash drive and confirm with "OK". The certificate will be imported and displayed in the list on the "Stores" tab.
8. You can use the "View.." button to display the properties of a certificate.

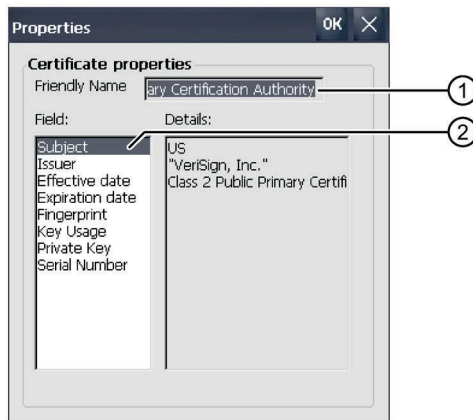

- ① Name of the selected certificate
- ② Identity information and other properties of the selected certificate

9. You can use the "Remove" button to delete a certificate.

Note

The entry is deleted immediately and without further inquiry. If you want to again use a deleted certificate, you need to import it again from a storage medium.

10. Confirm your entries with "OK".

The dialog closes.

The list of certificates on the HMI device is updated.

4.3.8 Enabling PROFINET

PROFINET services must be enabled on the HMI device in the following circumstances:

- The HMI device is connected to the controller over PROFINET.
- Function keys or buttons are configured as PROFINET IO direct keys in the project.
- The backlighting of the HMI device is to be controlled with PROFlenergy.

Note

If you enable PROFINET services, you cannot use the RS 422/RS 485 port as a serial interface.

PROFINET IO direct keys and PROFIBUS DP direct keys are mutually exclusive.

Requirement

The Control Panel is open.

Procedure



1. Open the "Profinet" dialog using the "PROFINET" icon.

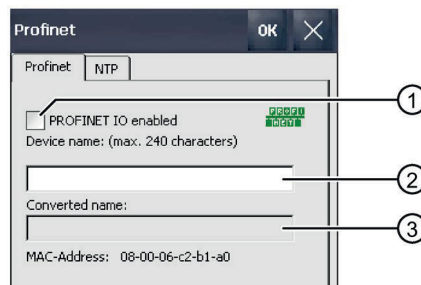

- ① Enables or disables the PROFINET IO direct keys
- ② Text box for the device name
- ③ MAC address of the HMI device

2. Select the "PROFINET IO enabled" check box.

Note

PROFINET device name must match the PROFINET device name in WinCC

If the PROFINET device name does not match the PROFINET device name entered in WinCC, the direct keys will not work.

Use the same PROFINET device names in WinCC and the Control Panel. The device name from WinCC can be automatically applied to the device during the transfer, depending on the settings in the project.

The PROFINET device name is independent of the computer name, which is specified in the Control Panel under "System Properties".

You can find details on configuring the PROFINET device names in the WinCC information system.

3. Enter the PROFINET device name of the HMI device.

The device name must be unique and satisfy the DNS conventions within the local network. These include:

- The length of the name is limited to 240 characters (lower case letters, numbers, hyphens or periods).
- A name component within the device name, i.e. a string between two periods, must not exceed 63 characters.
- Special characters such as umlauts, brackets, underscores, slashes, spaces, etc. are not permitted. The hyphen is the only permitted special character.
- The device name must not start or end with the "-" character.
- The device name must not start with a number.
- The device name must not take the form n.n.n.n (n = 0 ... 999).
- The device name must not start with the character string "port-xyz" or "port-xyz-abcde" (a, b, c, d, e, x, y, z = 0 ... 9).

4. Confirm your entries.
The dialog closes.

5. Restart the HMI device, see section "Switching on and testing the device (Page 57)".

PROFINET is enabled.

Notes on PROFlenergy

If backlighting is switched off, you can switch it on again using PROFlenergy. You can also reactivate backlighting on the HMI device as follows:

- When the touch screen is briefly touched or a key is pressed, the screen brightness is set to full brightness.
- If you press the touch screen or the "Cursor up" key for a long time, the screen brightness increases incrementally.

4.3.9 Enabling NTP

To obtain the time of the HMI device from a time server, you can specify up to four different time servers. The time is synchronized using the "Network Time Protocol". The synchronization cycle applies to all configured time servers.

Requirement

- The HMI device and time server are located in the same network.
- The Control Panel is open.

Procedure



1. Open the "Profinet" dialog using the "PROFINET" icon.
2. Change to the "NTP" tab.

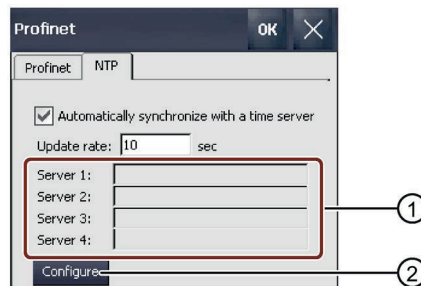

- ① Text box for time servers 1 to 4
- ② Button for configuring the time servers

3. If you want to use the time of a time server, activate "Automatically synchronize with ...".
4. Under "Update rate", enter the time interval in seconds after which the HMI device is to synchronize the time.
Permitted value range: 1 ... 60 000 000 seconds.
5. Press the "Configure" button.
The following dialog is displayed:

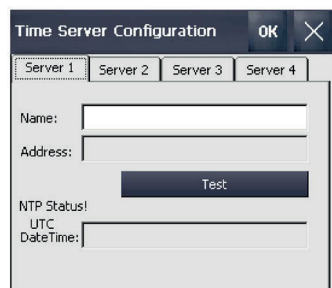

If you do not enter a time, the message "Second field wrong data type." will appear. Enter a time.

6. Enter the DNS name of the time server under "Name".
You can also enter the IP address of the time server.

4.3 Parameterizing the Comfort Panel

7. Use the "Test" button to check the accessibility of the time server.
The communication connection to the time server is established and the time is displayed in the "Date/Time:" display field. The IP address of the time server is also displayed in the "Address" display.
8. Up to three additional time servers can be set up, if needed.
9. Confirm your entries with "OK".

The communication connection to the time server is now set up and immediately active.

4.3.10 Configuring network operation

4.3.10.1 Overview

Introduction

You can connect the HMI device to a PROFINET network by using the Ethernet port.

Note

The HMI device only has client functionality in the PC network. This means that users can access files of a node with TCP/IP server functionality from the HMI device by means of the network. But you cannot access files of the HMI device, for example, from a PC by means of the network.

If you are using the Sm@rtServer option on the HMI device, operator control and monitoring of the HMI device is possible from a Sm@rt Client device. A PC or another HMI device can serve as a Sm@rt Client, for example.

Note

Information on communication using SIMATIC S7 via PROFINET is provided in the online help of WinCC.

The connection to a network offers, for example, the following options:

- Printing on a network printer
- Saving, exporting and importing of recipe data records on or from a server
- Setting up of alarm and data logs
- Transferring a project
- Saving data

Addressing

Within a PROFINET network, computers are usually addressed using computer names. These device names are translated from a DNS or WINS server to TCP/IP addresses. This is why you need a DNS or WINS server for addressing by means of computer names when the HMI device is in a PROFINET network.

The corresponding servers are generally available in PROFINET networks.

Note

The use of TCP/IP addresses to address PCs is not supported by the operating system.

Contact your network administrator if you have questions in this regard.

Printing on a network printer

The operating system of the HMI device does not support line by line alarm logging on a network printer. All other printing functions, for example, hard copy or logs, are available without restriction by means of the network.

Preparation

Before you start with the configuration, request the following network parameters from your network administrator:

- Does the network use DHCP for dynamic assignment of network addresses?
If not, get a new TCP/IP network address for the HMI device.
- Which TCP/IP address does the default gateway have?
- If a DNS network is used, what are the addresses of the name server?
- If a WINS network is used, what are the addresses of the name server?

General procedure for configuring the network

The HMI device must be configured prior to network operation. The configuration is basically divided into the following steps:

Proceed as follows:

1. Enter the device name of the HMI device.
2. Configure the network address.
3. Set the logon information.
4. Save the settings.

You can also configure the network address in the "Devices & Networks" editor in WinCC. You can find more information on this topic in the WinCC online help.

For data exchange, we recommend using the "Option+" software. Additional information can be found on the Internet (<https://support.industry.siemens.com/cs/ww/en/view/92346478>).

4.3.10.2 Specifying the computer name of the HMI device

You can use this function to assign a computer name to the HMI device. The computer name is used to identify the HMI device in the local network.

Requirement

The Control Panel is open.

NOTICE
Computer name must be unique
Communication errors may occur in the local network if you assign a computer name more than once.
Enter a unique computer name in the ""Device name"" text box.

Procedure



1. Open the "System Properties" dialog using the "System" icon.
2. Change to the "Device Name" tab.

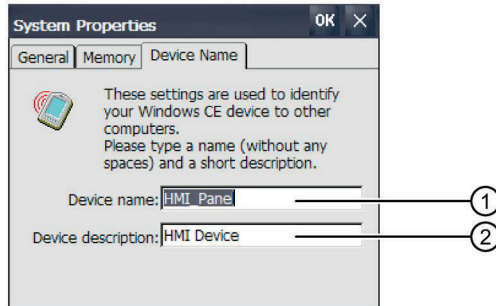

- ① Computer name of the HMI device
 - ② Brief description of the HMI device (optional)
3. Enter the computer name for the HMI device in the "Device name" text box. Enter the name without spaces.
 4. If necessary, enter a description for the HMI device in the "Device description" text box.
 5. Confirm your entries with "OK".
The dialog closes.

The computer name for the HMI device is now set.

4.3.10.3 Entering the IP address and name server

You can change the network settings for the LAN connection under "Network&Dial-Up Connections". You can also configure the properties of the Ethernet ports of the HMI device.

Requirement

The Control Panel is open.

Procedure

Proceed as follows:

1. Open the network adapter display using the "Network&Dial-Up Connections" icon.
The image below shows the network adapter of a KP1500 Comfort.



The second network adapter "PN_X3" is present for the Comfort devices as of 15".

2. Open the "PN_X1" entry.
The 'PN_X1' Settings dialog opens.
3. Change to the "IP Address" tab.

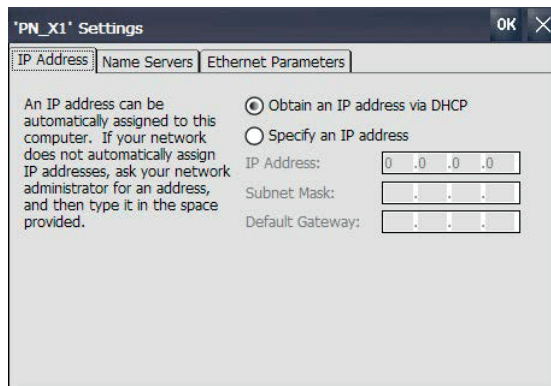

4. Select the type of address assignment:
 - To determine the address automatically, select "Obtain an IP address via DHCP".
 - To determine the address manually, select "Specify an IP address".

5. If you have selected manual address assignment, enter the corresponding addresses under "IP Address", "Subnet Mask" and under "Default Gateway", if necessary.

Note

PROFINET I/O error if the PN_X1 and PN_X3 subnet masks are identical

In principle, the two network adapters may be assigned to a shared physical subnetwork.

If you have enabled PROFINET services for PN_X1 and the IP subnet masks of the two network adapters are identical, PROFINET I/O errors may occur.

Assign a different entry for each network adapter in PROFINET I/O operation under "Subnet Mask".

Note

You can also configure the network address in the "Devices & Networks" editor in WinCC. You can find more information on this topic in the WinCC online help.

6. If a name server is used in the network, change to the "Name Servers" tab.

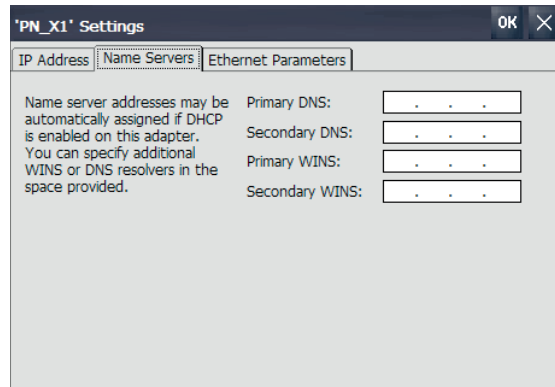

7. Enter the corresponding addresses.

8. If you want to set additional Ethernet parameters, open the "Ethernet Parameters" tab.

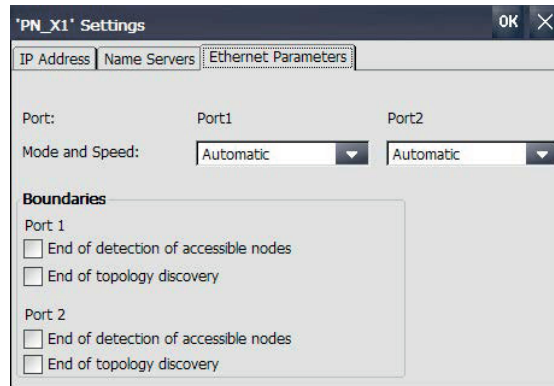

The KP400 Comfort and KTP400 Comfort HMI devices only have one Ethernet interface "Port1".

9. The transmission mode and the speed of the Ethernet ports are set automatically by default. If needed, select the transmission mode and speed for the Ethernet port of the HMI device. You can also set limits for the two Ethernet ports:
- "End of detection of accessible nodes": DCP frames for detecting accessible nodes are not forwarded. Nodes located beyond this Ethernet port are no longer accessible.
 - "End of topology discovery": LLDP frames for topology discovery are not forwarded.

Note

For the HMI devices KP400 Comfort and KTP400 Comfort, only the "End of topology discovery" option is available.

10. Change the limits for the Ethernet ports "Port 1" and "Port 2", if needed. The KP400 Comfort and KTP400 Comfort HMI devices only have one Ethernet interface "Port1".
11. Confirm your entries with "OK".

The LAN connection parameters for the HMI device have been changed.

See also

Parameterizing Transfer (Page 99)

4.3.10.4 Changing MPI/PROFIBUS DP settings

The communication settings for MPI or PROFIBUS DP are defined in the project of the HMI device.

In the following cases, the transfer settings may have to be changed:

- The first time the project is transferred
- If changes are made to the project but are only applied later

Note

Transfer mode using MPI/PROFIBUS DP

The bus parameters are read from the project currently loaded on the HMI device.

The settings for MPI/PROFIBUS DP transfer can be modified. The following steps are required:

- Close the project.
- Change the settings on the HMI device.
- Then return to "Transfer" mode.

The changed MPI/PROFIBUS DP settings will be overwritten in the following cases:

- The project is started again
- A project is transferred and started

Note

Transfer settings

If the HMI device is in "Transfer" mode while changes are made to the transfer settings, the settings only go into effect after the transfer function is restarted.

Requirement

- The "Transfer Settings" dialog is open.
- The transfer channel "MPI" or "PROFIBUS" is selected.

Procedure

1. Open the "MPI" or "PROFIBUS" dialog using the "Properties..." button.

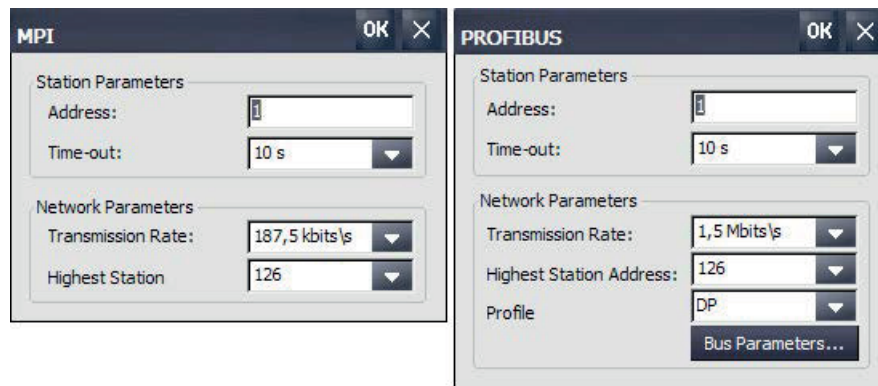

2. Enter the bus address for the HMI device under "Address".

Note

The bus address in the "Address" text box must be unique throughout the MPI/PROFIBUS DP network.

3. Select the transmission rate under "Transmission Rate".
4. Enter the highest station address on the bus under "Highest Station Address" or "Highest Station".
5. PROFIBUS only: Select the desired profile under "Profile".
You can use "Bus Parameters" to display the profile data.

Note

The bus parameters must be the same for all stations in the MPI/PROFIBUS DP network.

6. Confirm your entries with "OK".

The MPI/PROFIBUS DP settings of the HMI device have been changed.

See also

Parameterizing Transfer (Page 99)

4.3.10.5 Specifying the logon data

Use this function to enter the information for logging onto local networks.

Requirement

- The Control Panel is open.
- Your system administrator has provided you with the necessary information.

Procedure



1. Open the "Network ID" dialog using the "Network ID" icon.

2. Enter your user name in the "User name" text box.
3. Enter your password in the "Password" text box.

4. Enter the name of your assigned domain in the "Domain" text box.
5. Confirm your entries with "OK".
The dialog closes.

The logon data has now been set.

4.3.10.6 Configuring e-mail

You use this function to set the SMTP server, sender name and e-mail account for e-mail service.

Requirement

- The Control Panel is open.
- Your system administrator has provided you with the necessary information.

Note

Additional tabs may appear in the "WinCC Internet Settings" dialog. This depends on the options that have been enabled for operating the local network in the project.

Procedure



1. Open the "WinCC Internet Settings" dialog using the "WinCC Internet Settings" icon.
2. Change to the "Email" tab.

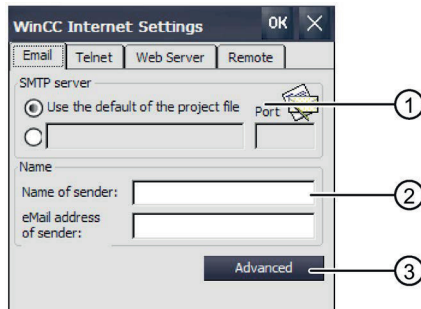

- ① Setting of the SMTP server
 - ② Name of the sender and e-mail account
 - ③ "Advanced" button for additional settings
3. Specify the SMTP server.
 - Select the "Use the default of ..." option if you want to use the SMTP server configured in the project.
 - Clear the "Use the default of ..." option if you do **not** want to use the SMTP server configured in the project. Enter the required SMTP server and the corresponding port.
 4. Enter the name of the sender in the "Name of sender" entry field.
The computer name is an appropriate sender name – see section "Specifying the computer name of the HMI device (Page 124)".

5. Enter the e-mail account you use to send your e-mail in the "eMail address of sender" entry field.
The "eMail address of sender" entry field can remain empty if your e-mail provider allows e-mails to be sent without checking the e-mail account.

6. If you want to make further settings for sending e-mails over an SMTP server, press the "Advanced" button. The following dialog appears:

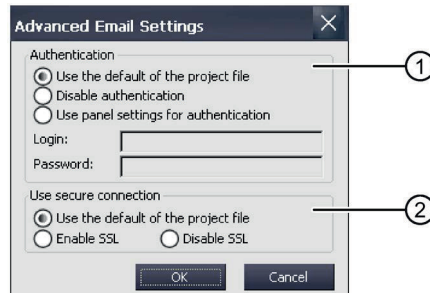

- ① Options for authentication on the SMTP server
- ② Encryption options

7. Specify an option for authentication on the SMTP server.
 - Select the "Use the default of ..." option if you want to use authentication data specified in the project.
 - If you use an SMTP server that does not require authentication, select the "Disable authentication" option.
 - Select the "Use panel settings for authentication" option if you want to use the authentication data specified in the settings of the HMI device instead of those in the project. Enter the user name and password.
8. Enter a secure connection.
 - Select the "Use the default of the project file" option if you want to use the secure connection of the project.
 - Select the "Enable SSL" option if you want to enable SSL.
 - Select the "Disable SSL" option if you want to disable SSL.
9. Confirm your entries with "OK".
The dialog closes.
10. Close the "WinCC Internet Settings" dialog with "OK".
The e-mail settings have been changed.

4.3.10.7 Configuring Telnet for remote control

When the Telnet service is activated, you can remotely control the HMI device via Telnet. As of HMI device image version 16.0.0.4, the specifications under "Authentication" are available.

Requirement

The Control Panel is open.

Procedure



1. Open the "WinCC Internet Settings" dialog using the "WinCC Internet Settings" icon.
2. Change to the "Telnet" tab.

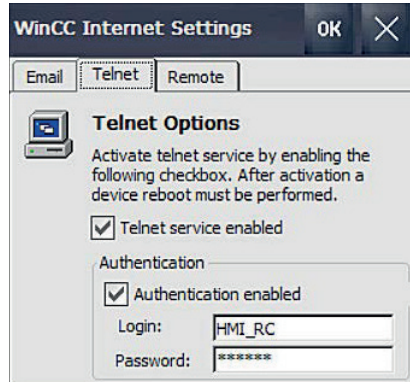

3. If you want to use the Telnet service, select the "Telnet service enabled" option.
4. If you are using a HMI device image version <16.0.0.4, save the setting with "OK".

Activating Telnet authentication

This function is available as of HMI device image version 16.0.0.4. Activate the Telnet authentication as follows:

1. Select the "Authentication enabled" check box.
2. Enter a login and password.
3. Save your settings with "OK".

Changing the login and password

1. Change the login and password.
2. Save your settings with "OK".

The new login and password are active; the previous login and password have been deleted.

Deactivating Telnet authentication

1. Clear the "Authentication enabled" check box.
2. Save your settings with "OK".

Telnet authentication is disabled, login and password are locked. After the Telnet authentication is reactivated, login and password are unlocked again.

Deactivating the Telnet service

When you deactivate the Telnet service, the settings under "Authentication" are blocked. After the Telnet service is reactivated, the previous settings under "Authentication" are unlocked again.

4.3.10.8 Configure Sm@rt Server

You can use this option to configure the Sm@rtServer for the HMI device. You can then access the HMI device using a Web browser, the Sm@rtClient app or other Java-based clients. Operator control and monitoring of the HMI device is possible, depending on the parameter assignment of the Sm@rtServer.

Requirement

- For HMI devices with an image that is compatible with WinCC (TIA Portal) prior to V14, the following applies: The HMI device has a Sm@rt Server license that was transferred to the HMI device via the Automation License Manager. Starting with WinCC (TIA Portal) V14, the Sm@rtServer option for Comfort Panels is license-free.
- The HMI device has a project that was compiled with option "Runtime settings > Services > Remote control > Start Sm@rtServer".
- The Control Panel is open.
- Your system administrator has provided you with the necessary information for parameter assignment of the Sm@rtServer.

Note

The "Remote" tab is only available if the HMI device has a project that was created with the "Start Sm@rtServer" option.

Additional tabs may appear in the "WinCC Internet Settings" dialog. This depends on the options that have been enabled for operating the local network in the project.

Procedure



1. Open the "WinCC Internet Settings" dialog using the "WinCC Internet Settings" icon.
2. Change to the "Remote" tab.

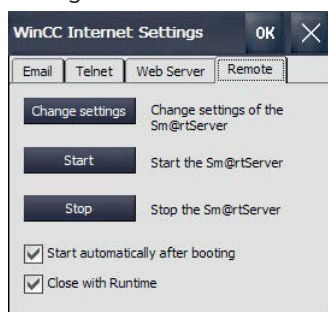

3. Select the options for starting and closing the Sm@rtServer.
 - If the Sm@rtServer is to be started immediately after power-up of the HMI device, select the "Start automatically after booting" option. If this option is disabled, the Sm@rtServer must be started manually using the "Start" button or a corresponding element in the project.
 - Select the "Close with Runtime" option if the Sm@rtServer is to be closed together with the project. If this option is disabled, the Sm@rtServer continues running after the project is closed.

4. Press the "Change Settings" button.

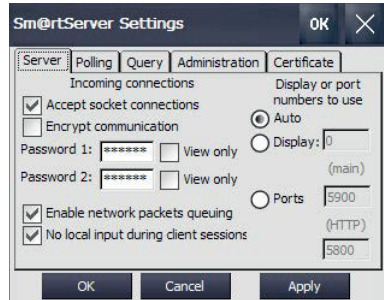

5. Assign two new passwords under "Password 1" and "Password 2". You enter one of the two passwords when accessing the Sm@rtServer.
6. Save the settings using "Apply".
7. Adapt the other settings in the "Server", "Polling", "Query", "Administration" and "Certificate" tabs, if necessary. You can find a description of these settings in the WinCC information system. e.g. by searching for "Sm@rt".
8. Press the "Start" button to start the Sm@rtServer on the HMI device. Use the "Stop" button to close Sm@rtServer.
9. Close the dialog with "OK".

Once the Sm@rtServer has started, you can access the HMI device by specifying the port number and server name/server IP address, e.g. using the Sm@rtClient application or Internet Explorer Version 6 or higher.

Example: The IP address of the Sm@rtServer is 192.168.0.1, and port 5800 is set on the Sm@rtServer.

- Example of call via Internet Explorer: "http://192.168.0.1:5800".
- Example of call via the Sm@rtClient application: "192.168.0.1".

4.3.10.9 Configure Web Server

You can use this option to configure the HMI device as HTTP server. You can then view the HTML pages of the server HMI device using a Web browser or access the tags of the server HMI device using the "SIMATIC HMI HTTP Protocol". Read or write access to the tags is possible, depending on the parameter assignment of the Web Server.

Requirement

- The Web Server is a component of the Sm@rtServer option. For HMI devices with an image that is compatible with WinCC (TIA Portal) prior to V14, the following applies: The HMI device has a Sm@rt Server license that was transferred to the HMI device via the Automation License Manager. Starting with WinCC (TIA Portal) V14, the Sm@rtServer option for Comfort Panels is license-free.

- The HMI device has a project that was compiled with one of the following options in the Runtime settings of the HMI device under "Runtime settings > Services":
 - "HTML pages"
 - "HTTP channel server"
 - "Web Service SOAP"
- The Control Panel is open.
- Your system administrator has provided you with the necessary information for parameter assignment of the Web Server.

Note

The "Web Server" tab is only available if the HMI device has a project that was compiled with one of the three Runtime settings listed under "Requirements".

Additional tabs may appear in the "WinCC Internet Settings" dialog. This depends on the options that have been enabled for operating the local network in the project.

Procedure



1. Open the "WinCC Internet Settings" dialog using the "WinCC Internet Settings" icon.
2. Change to the "Web Server" tab.

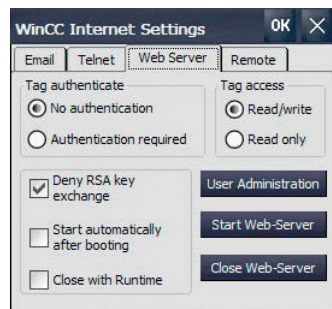

3. In the "Tag acces" group, define the type of access to the tags of the server HMI device.
 - "Read/write": Read and write access
 - "Read only": Read access
4. In the "Tag auhenticate" group, define the authentication required for access to the tags of the server HMI device:
 - "No authentication": No authentication required.
 - "Authentication required": A password is required for access.
Configure a connection with password protection for access using the SIMATIC HMI HTTP Protocol. In this case, you must select the "Authentication required" option; the associated password on the HMI device must match the password of the configured connection.

4.3 Parameterizing the Comfort Panel

5. Select the options for RSA key exchange and for starting and closing the Web server.
 - Enable or disable the "Deny RSA key exchange" option depending on the communication partner. This option is available as of firmware version V16.0.0.0.

In line with recommendations on the use of Transport Layer Security (TLS), RSA key exchange is denied by default as of firmware version 16.0.0.6 because it does not offer Perfect Forward Secrecy. If the communication partner requires RSA key exchange, you can allow this procedure by disabling the "Deny RSA key exchange" option.

If you want to find out which security-relevant protocols a device supports, you can use tools to test the SSL/TSL connection.
 - If the Web Server is to be started immediately after power-up of the HMI device, select the "Start automatically after booting" option. If this option is disabled, the Web Server must be started manually using the "Start Web-Server" button or a corresponding element in the project.
 - Select the "Close with Runtime" option if the Web Server is to be closed together with the project. If this option is disabled, the Web Server continues running after the project is closed.
6. Press the "User Administration" button.
7. Enter the administrator password if you are prompted to do so. The "UserDatabase-Edit" dialog box opens.
8. To create a new user, click "Add" in the "User Manager" tab. Enter a user name and specify a password. The user enters the associated password when accessing the Web Server.
9. Save the settings using "Apply".
10. Change to the "Authorizations" tab.
11. In the "Authorizations" tab you specify the Web authorizations. To use the SIMATIC HTTP server, the user must have the Web authorization "RTCommunication".
12. Save the settings using "Apply" and close the dialog box with "OK".
13. Press the "Start Web-Server" button to start the Web Server on the HMI device.
Use the "Close Web-Server" button to close Web Server.
14. Close the dialog with "OK".

When the Web Server is started, you can use a Web browser to access the service pages available on the HMI device by default, additional pages you have configured yourself or other Internet pages. You can access the tags of the server HMI device with a client via a configured HTTP connection.

Additional information on configuration, types of access and certificates is available in the TIA information system under:

"Visualize processes > Options > WinCC Sm@rtServer".

4.3.11 Functions for service and commissioning

4.3.11.1 Saving to external storage medium – backup

You can use this function to back up the operating system, applications and data from the flash memory of the HMI device to an external storage medium.

Use a SIMATIC HMI Memory card or an industry-compatible USB stick as the storage medium.

Requirement

- The Control Panel is open.
- There is a storage medium with sufficient free capacity in the HMI device.
- Data that must not be overwritten has been saved.

Procedure



1. Open the "Service & Commissioning" dialog using the "Service & Commissioning" icon.

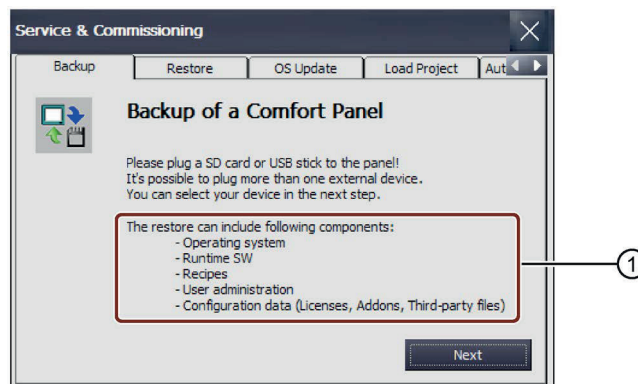

- ① Data that can be backed up

2. Press the "Next" button.

The following dialog appears:

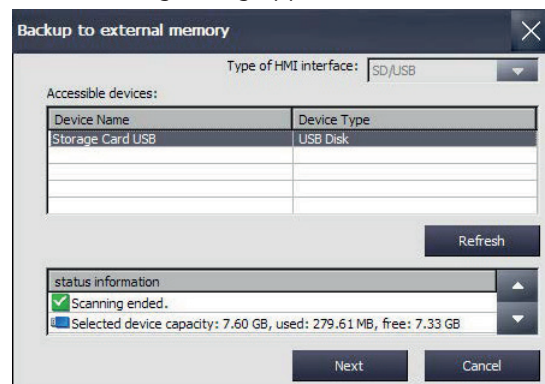

The "0 devices found" message appears if there is no storage medium in the HMI device or if it is defective. Insert a storage media or replace the storage medium.

3. Press the "Refresh" button if necessary.

The "Accessible devices" list is updated and the "status information" field contains information about the selected storage medium. Note the memory capacity displayed.

4. Select a storage medium from the "Accessible devices" list.
5. Press the "Next" button. The following dialog appears:

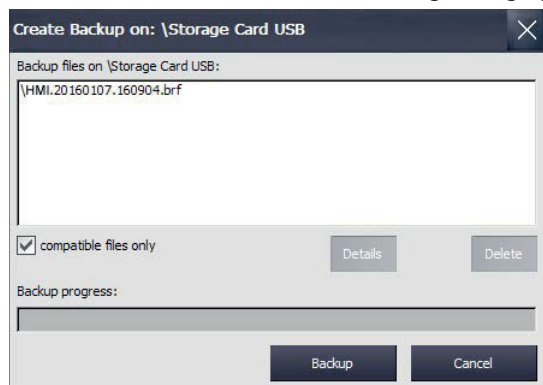

6. If you only want to backup compatible files, select the "compatible files only" check box.
 - Check box cleared:
The list displays all backup files. This gives the user an overview of the files stored on the storage medium.
 - Check box selected:
The list only displays the backups that are compatible with the device currently in use.
7. Press the "Backup" button.
The following dialog appears:

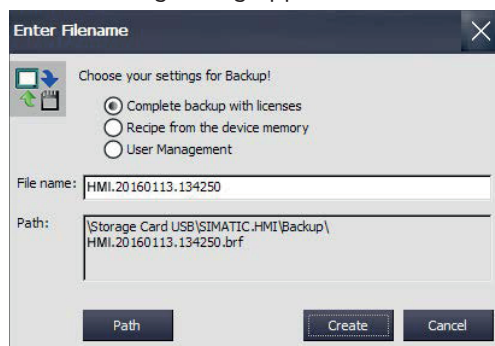

8. Use the option buttons to select the data you want to back up.
9. If required, change the file name in the "File name" field.
10. Press the "Create" button.
The "Create Backup" dialog is displayed. A progress bar shows the status of the data backup. When the backup process is completed, the "Backup operation successfully completed." message is displayed.
11. Acknowledge this message. The dialog closes.
12. Close the "Service & Commissioning" dialog.
The HMI device data is now saved on the storage medium.

See also

Accessories (Page 22)

4.3.11.2 Restoring from external storage medium – Restore

Use this function to restore data from a storage medium to the HMI device.

Compatibility

- The backup of a Comfort V1 device is compatible with the backup of a Comfort V1.1 device.
- The backup of a Comfort V1/1.1 device is **not** compatible with the backup of a Comfort V2 device.

A restore operation deletes the flash memory of the HMI device on confirmation. The data backed up on the storage medium is then transferred.

NOTICE

Data loss

All data on the HMI device, including the project and HMI device password, is deleted during a restore operation. License keys are only deleted after a security prompt.

Back up your data before the restore operation, if necessary.

Requirement

- The Control Panel is open.
- The storage medium with the backed up data is inserted in the HMI device.

Procedure



1. Open the "Service & Commissioning" dialog using the "Service & Commissioning" icon.
2. Change to the "Restore" tab.



3. Press the "Next" button. The "Restore from external memory" dialog is displayed.

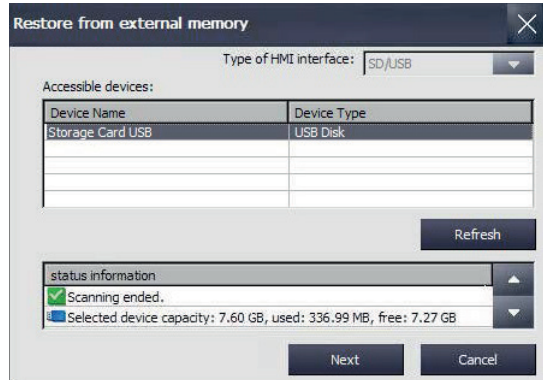

The "0 devices found" message appears if there is no storage medium in the HMI device or if it is defective. Insert a storage media or replace the storage medium.

4. Press the "Refresh" button, if necessary. The "Accessible devices:" group is updated. The HMI device checks the storage medium. Information about this storage medium is displayed in the "status information" field.
5. Select the storage medium with the required backup in the "Accessible devices:" group.
6. Press the "Next" button.

The following dialog is displayed.

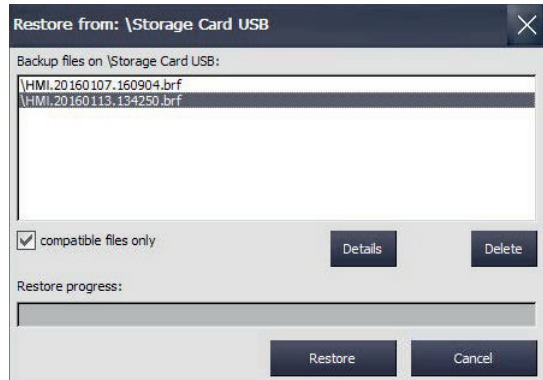

7. Select the required backup file in the "Backup files on" group.
8. If you need information about the selected file, press the "Details" button. The "Properties of backup file" dialog containing the following information is displayed:
 - "Supported": HMI device type that is compatible with the backup file
 - "Image version": Version of the HMI device image that is compatible with the backup file
 - "Image size": Size of the backup file
 - "Creation": Date the backup file was created
9. To delete the selected file, press the "Delete" button. The "Delete confirmation" dialog is displayed. The file will be deleted when you press "OK".

10. To restore the data from the selected file, select "Restore". The following dialog appears:

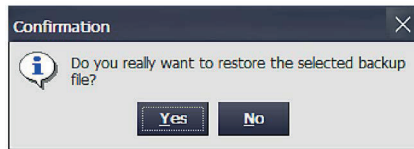

11. Selecting "Yes" restores the data.

The "Transfer" dialog appears. A progress bar shows the status of the restore process. When the restore operation is complete, the "Restore operation successfully completed." message is displayed. The HMI device then restarts.

12. Remove the storage medium, if necessary.

The data from the storage medium is now restored on the HMI device.

Note

After restoring, a recalibration of the touch screen may be required, see also section "Calibrating the touch screen (Page 91)".

4.3.11.3 Updating the operating system

NOTICE

Updating the operating system deletes all data on the HMI device

If you update the operating system, data on the target system are deleted. Therefore, first back up the following data:

- User administration
- Recipes

A reset to the factory settings also deletes the license keys. Back up the license keys as well before restoring the factory settings.

NOTICE

Automatic backup and updating the operating system

When the "Automatic backup" function is activated while the operating system is being updated, the HMI device may not start up again correctly.

If you want to update the operating system of the HMI device and have activated the "Automatic backup" function, follow these steps:

1. Deactivate the "Automatic backup" function.
2. Update the operating system.
3. Activate the "Automatic backup" function.

Leave the system memory card in the HMI device before and during the entire operating system update.

Requirement

- The Control Panel is open.
- A SIMATIC HMI Memory card or an industrial grade USB stick with an HMI device image file including the operating system is plugged into the HMI device.
You can find the HMI device image files, for example, in the WinCC installation directory under "`\\Siemens\Automation\Portal V14\Data\Hmi\Transfer\<HMI device image version>\Images`".

Procedure



1. Open the "Service & Commissioning" dialog using the "Service & Commissioning" icon.
2. Change to the "OS Update" tab.



3. Press the "Next" button.
The "Update OS image from external memory" dialog is displayed.

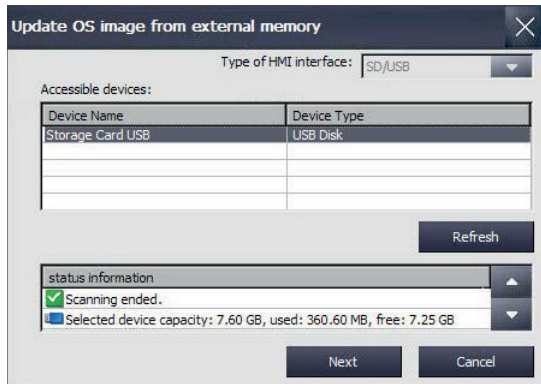

The "0 devices found" message appears if there is no storage medium in the HMI device or if it is defective. Insert a storage media or replace the storage medium.

4. Press the "Refresh" button, if necessary. The "Accessible devices:" group is updated. The HMI device checks the storage medium. Information about this storage medium is displayed in the "status information" field.
5. Select the storage medium with the required HMI device image in the "Accesible devices:" group.

6. Press the "Next" button. The following dialog is displayed.

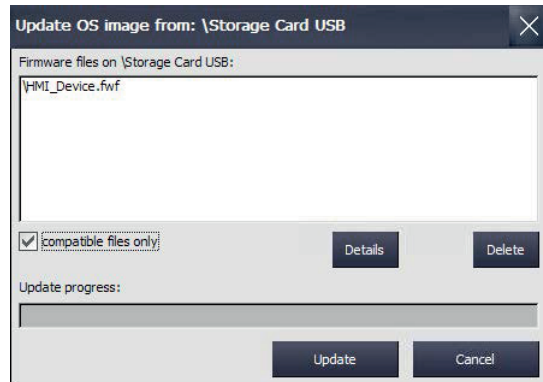

7. Select the required HMI device image file in the "Firmware files on" group.
8. If you need information about the selected file, press the "Details" button. The "Properties of image file" dialog containing the following information is displayed:
 - "Supported": HMI devices that are compatible with the HMI device image
 - "Image version": Version of the HMI device image
 - "Image size": Size of the image file
 - "Creation": Date the image file was created
9. To delete the selected file, press the "Delete" button. The "Delete confirmation" dialog is displayed. The file will be deleted when you press "OK".
10. To restore the data of the selected file, press the "Update" button.

The "Update settings" dialog is displayed.

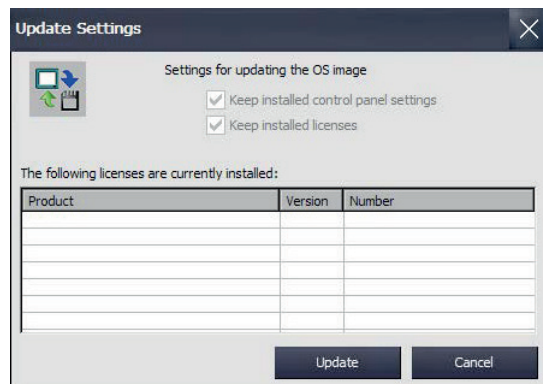

The dialog informs you that the settings in the Control Panel will be kept and offers you the option of keeping or deleting license keys present on the HMI device.

11. Press the "Update" button. The "Update OS Image" dialog is displayed.

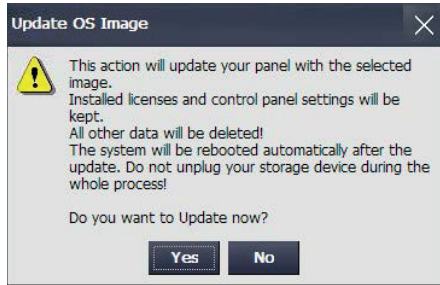

12. Press the "Yes" button to start the restoration of the operating system.

The "Transfer" dialog is displayed. A progress bar shows the status of the restore process. The HMI device then restarts.

The operating system on the HMI device is updated.

Note

After restoring, a recalibration of the touch screen may be required, see also section "Calibrating the touch screen (Page 91)".

See also

Restoring from external storage medium – Restore (Page 139)

4.3.11.4 Load project from external storage medium

This function is available in connection with an HMI device image that is compatible with WinCC (TIA Portal) V14 or higher.

You can use this function to load a project that was backed up to a storage medium in WinCC (TIA Portal) into the HMI device.

You generate the necessary project data in WinCC by configuring the HMI device and then using drag-and-drop to move the folder of the HMI device (e.g. "HMI_1 [<DeviceType>]") to an external storage medium (📁 icon) under "Card Reader/USB memory".

Recommendation: The Runtime and firmware versions of the project should match those of the HMI device.

Requirement

- The Control Panel is open.
- The storage medium with the backed up project is inserted in the HMI device.

Procedure



1. Open the "Service & Commissioning" dialog with the Service & Commissioning icon.
2. Change to the "Load Project" tab.

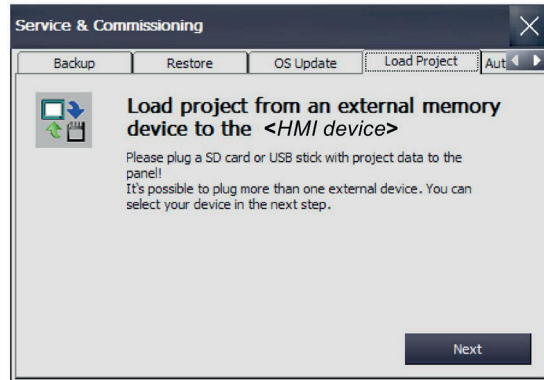

3. Press the "Next" button. The "Load from external memory device" dialog is displayed.

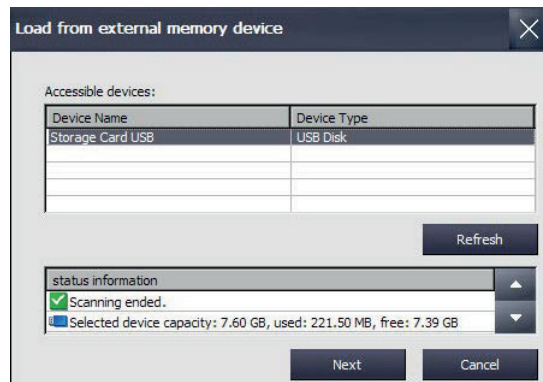

4. Select the storage medium with the project data in the "Accessible devices" group.
5. Press the "Next" button. The projects that are located on the external storage medium are displayed in the following dialog. The following figure shows an example.

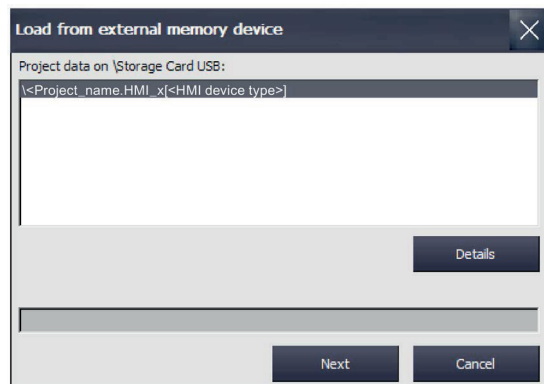

6. Select the project that you want to load into the HMI device. Press the "Details" button to receive additional information about the selected project.

- Press the "Next" button. The HMI device checks whether the project data can be loaded. The result of the check is displayed in the "Load Preview" dialog.

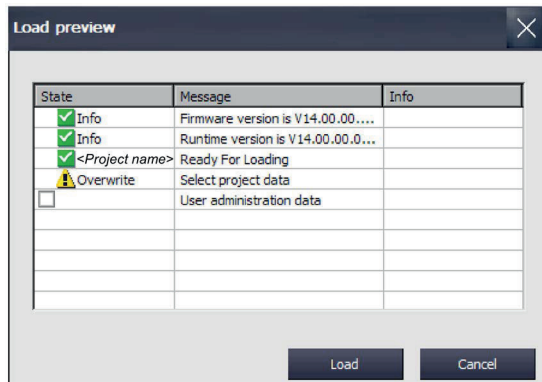

The following messages can be displayed in the "Load Preview" dialog:





- Alarms of type "Information":

Icon	Status	Alarm	Meaning
	Info	Firmware version ... Runtime version ...	Firmware and Runtime version on the HMI device
	Info	Ready For Loading	Project data is suitable for the HMI device

- Alarms of type "Warning" with options:

Icon	Status	Alarm	Meaning
	Overwrite	Select project data	The following lines contain options for overwriting data on the HMI device.
<input type="checkbox"/>		Recipes	Overwrite recipes of the HMI device with the recipes of the project (optional).
<input type="checkbox"/>		User administration data	Overwrite the user administration on the HMI device with the user administration of the project (optional).
<input type="checkbox"/>	Upgrade	Runtime upgrade	Runtime version on the HMI device is older than the Runtime version of the project, versions are compatible, upgrade of Runtime version on the HMI device is optional.
<input type="checkbox"/>	Upgrade	Firmware upgrade	Firmware version on the HMI device is older than the firmware version of the project, versions are compatible, upgrade of firmware on the HMI device is optional.
<input type="checkbox"/>	Downgrade	Runtime downgrade	Runtime version on the HMI device is newer than the Runtime version of the project, versions are compatible, downgrade of Runtime version on the HMI device is optional.
<input type="checkbox"/>	Downgrade	Firmware downgrade	Firmware version on the HMI device is newer than the firmware version of the project, versions are compatible, downgrade of firmware on the HMI device is optional.

- Alarms of type "Error" with option:

Icon	Status	Alarm	Meaning
<input type="checkbox"/> 	Upgrade	Runtime upgrade	Runtime version on the HMI device is older than the Runtime version of the project, versions are incompatible, upgrade of Runtime version on the HMI device is required.
<input type="checkbox"/> 	Upgrade	Firmware upgrade	Firmware version on the HMI device is older than the firmware version of the project, versions are incompatible, upgrade of firmware on the HMI device is required.
<input type="checkbox"/> 	Downgrade	Runtime downgrade	Runtime version on the HMI device is newer than the Runtime version of the project, versions are incompatible, downgrade of Runtime version on the HMI device is required.
<input type="checkbox"/> 	Downgrade	Firmware downgrade	Firmware version on the HMI device is newer than the firmware version of the project, versions are incompatible, downgrade of firmware on the HMI device is optional.
<input type="checkbox"/> 	Download	Runtime download	There is no Runtime software on the HMI device, e.g. after update of the operating system. Runtime software must be downloaded.

NOTICE

Data loss

If you enable the "Firmware upgrade" or "Firmware downgrade" option, the operating system of the HMI device will be updated. All data on the HMI device, including the HMI device password, is deleted in the process. Settings in the Start Center are retained. License keys are backed up to the external storage medium before the operating system update.

Back up your data before the load operation, if necessary.

NOTICE

Automatic backup and updating the operating system

When the "Automatic backup" function is activated while the operating system is being updated, the HMI device may not start up again correctly.

If you want to update the operating system of the HMI device and have activated the "Automatic backup" function, follow these steps:

1. Deactivate the "Automatic backup" function.
2. Update the operating system.
3. Activate the "Automatic backup" function.

Leave the system memory card in the HMI device before and during the entire operating system update.

The project can be loaded into the HMI device if no "Error..."-type alarms occur or if all "Upgrade/Downgrade" options were enabled for the "Error..."-type alarms.

8. Press the "Load" button to transfer the project data with the selected options to the HMI device.

The new project starts on the HMI device after the load operation.

See also

Updating the operating system (Page 141)

4.3.11.5 Using automatic backup

When you activate the "Automatic backup" function, the data of the HMI device is automatically backed up to the system memory card during operation in form of a backup including firmware. Backup is synchronized. You can insert the system memory card into any HMI device of the same type. After data is copied and a restart has been performed, the HMI device of the same type is operational.

Note

Use only a SIMATIC HMI Memory Card as the system memory card.

Only the SIMATIC HMI Memory Card ≥ 2 GB may be used as a system memory card. All other memory cards are not recognized as system memory card by the HMI device.

Note

System memory card in a device of a different type

If you use the system memory card of an HMI device in an HMI device of a different type, an error message is displayed.

For service purposes, use a system memory card only in HMI devices of the same type.

Note

Do not remove the system memory card for "automatic backup" during operation

If the "Automatic backup" function is activated, the system memory card may only be removed when the HMI device is switched off.

NOTICE

Automatic backup and updating the operating system

When the "Automatic backup" function is activated while the operating system is being updated, the HMI device may not start up again correctly.

If you want to update the operating system of the HMI device and have activated the "Automatic backup" function, follow these steps:

1. Deactivate the "Automatic backup" function.
2. Update the operating system.
3. Activate the "Automatic backup" function.

Leave the system memory card in the HMI device before and during the entire operating system update.

The "Automatic Backup" is enabled in the delivery state of the device.

Requirement

- The Control Panel is open.

Enabling and disabling automatic backup



1. Open the "Service & Commissioning" dialog using the "Service & Commissioning" button.
2. Change to the "Automatic Backup" tab.

If the "Automatic Backup" function was enabled ("Enabled: Yes"), the "Disable & Reboot" button is displayed.



You can see whether or not a system memory card is inserted under "Attached:".

- "Attached: Yes" means that a system memory card is in the corresponding slot of the HMI device. The "Safely remove" button is also displayed. Always use the "Safely remove" function to remove the system memory card from the HMI device.
- "Attached: No" means that no system memory card is in the corresponding slot of the HMI device or that the system memory card was not recognized.

If the "Automatic Backup" function is currently disabled ("Enabled: No"), the "Enable & Reboot" button is displayed.

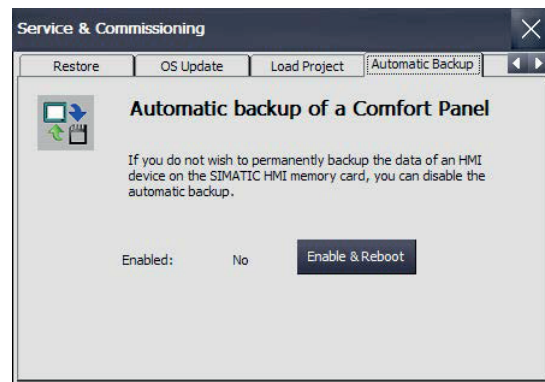

3. Press the "Disable & Reboot" or "Enable & Reboot" button to disable or enable the automatic backup.
The "System card" dialog is displayed.
4. Press the "Yes" button.

Note

There is no message whether a storage medium is inserted / not inserted.

An automatic restart is carried out.

Applications

We differentiate between the following different cases, depending on whether the system memory card was previously used for automatic backup:

Using the system memory card without automatically backed up data

1. In the "Service & Commissioning" dialog, "Automatic Backup" tab, check whether the "Automatic Backup" function is enabled.
 - If the function is enabled, close the dialog.
 - If the function is not enabled, press the "Enable & Reboot" button.
2. Insert the SIMATIC HMI Memory Card without automatic backup into the slot for the system memory card.

If the system memory card was recognized and read, the "Use system card" dialog is displayed as follows:

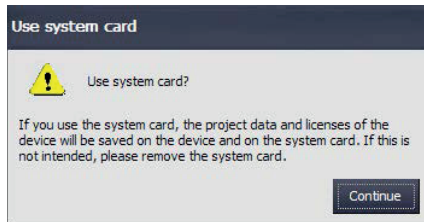

3. Press the "Continue" button. The device copies the data that is required for the "Automatic Backup" function onto the system memory card.

The "Automatic Backup" function is then available.

Using system memory card with automatically backed up data, no project data on the HMI device

1. In the "Service & Commissioning" dialog, "Automatic Backup" tab, check whether the "Automatic Backup" function is enabled.
 - If the function is enabled, close the dialog.
 - If the function is not enabled, press the "Enable & Reboot" button.
2. Insert the SIMATIC HMI Memory Card without automatic backup into the slot for the system memory card.

If the system memory card was recognized and read, the "Use system card" dialog is displayed as follows:

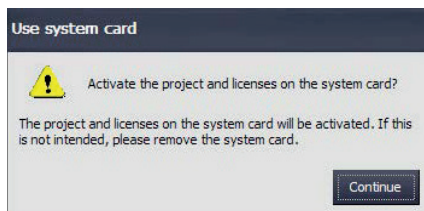

3. Press the "Continue" button.

The data of the system memory card is transferred to the HMI device.

After the data transfer, the state of the HMI device is the same as that of the HMI device used to generate the automatic backup.

Using system memory card with automatic backup, project data on the device

NOTICE**Data loss**

All data on the HMI device, including the project and HMI device password, is deleted during a restore operation. License keys are only deleted after a security prompt.

Back up your data before the restore operation, if necessary.

1. In the "Service & Commissioning" dialog, "Automatic Backup" tab, check whether the "Automatic Backup" function is enabled.
 - If the function is enabled, close the dialog.
 - If the function is not enabled, press the "Enable & Reboot" button.
2. Insert the SIMATIC HMI Memory Card with automatic backup into the slot for the system memory card.

If the system memory card was recognized and read, the "Use system card" dialog is displayed as follows:

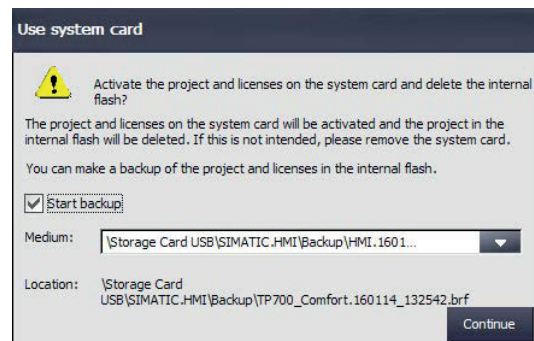

3. Select the "Start backup" check box in order to create a backup of the device data on an external storage medium before the device data is overwritten by the data on the system memory card. Select the corresponding path and file name under "Medium:".
4. Press the "Continue" button. If the "Start backup" check box was selected, the device then creates a corresponding data backup.

The data of the system memory card is then transferred to the HMI device.

After the data transfer, the state of the HMI device is the same as that of the HMI device used to generate the automatic backup.

See also

Accessories (Page 22)

Saving to external storage medium – backup (Page 137)

Changing the memory cards (Page 67)

4.3.11.6 Editing IP addresses and communication connections

Overview

This section describes how you can, from your HMI device, change the IP addresses of controllers and other HMI devices in the subnet of your HMI device and adapt the associated communication connections accordingly. This gives you the ability to create a project, transfer it to multiple HMI devices and then adapt the respective controller connections without changing the project.

If you change the IP addresses of other devices in the subnet of your HMI device, the following steps are required:

- Update IP address and device name; see section "Assigning IP address and device name (Page 152)"
- Update communication connection; see section "Configuring a communication connection (Page 156)".

The following functions are also available:

- A scan function to list the HMI devices and PLC in the subnet.
- Filter function for the scan results
- Check assignment of IP addresses and device names for HMI devices and PLCs.
- Project IP addresses and device names for HMI devices and PLCs can be restored.

Assigning IP address and device name

You can use the "Assign IP" function to edit the IP address and device name of target devices in the subnet of your HMI device. The target device can be a controller or another HMI device.

Requirement

- The Control Panel is open.
- For HMI devices, the following applies: The project that runs on the target device is closed.
- For controllers, the following applies:
 - The controller is of type S7-300, S7-400, S7-1200 or S7-1500.
 - HMI access is allowed in the settings.
 - The controller is in "STOP" state.
- Your system administrator has provided you with the necessary information.

Procedure



1. Open the "Service & Commissioning" dialog using the "Service & Commissioning" icon.
2. Change to the "IP Config" tab.

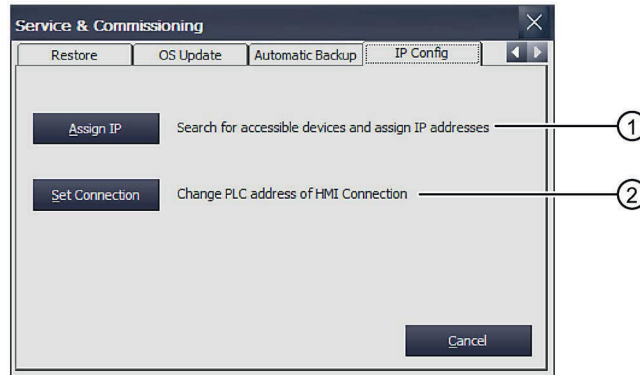

- ① Button for changing IP address and device name
- ② Button for changing the configured communication connections

3. Open the "Assign IP" dialog using the "Assign IP" button.

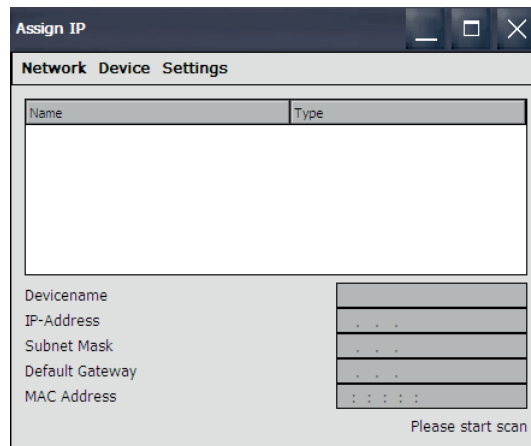

The following functions are available in the menu bar of this dialog:

Menu	Submenu/Entry		Function
Network	Scan	Start	Start search for available devices in the subnet of the HMI device
		Stop	Stop search for available devices in the subnet of the HMI device
	Exit		Close the "Assign IP" dialog
Device	Download	IP	Update IP address of the selected device
		Devicename	Update device name of the selected device
		All	Update IP address and device name of the selected controller
	Flash		Causes the display of the selected HMI device or the "RUN/STOP" LED of the selected controller to flash
	Reset to Factory		Deletes the IP address and device name of the selected device, provided that this function is supported by the selected device and allowed by the security settings.
Settings	Filter	All devices	Find all controllers in the subnet of the HMI device
		MAC Address	Find a controller with a specific MAC address
		Device Type	Find controllers of a certain type
	Interface		Select the interface of the HMI device for the search

4. Use "Settings > Interface" to select the interface of the HMI device that is connected to the subnet that is to be searched for other devices, e.g. X1.
5. If necessary, select "Settings > Filter" to find a controller with a specific MAC address or controllers of a certain type.
6. Select "Network > Scan > Start".
The search for accessible devices located in the subnet of your HMI device is started.
7. To stop scanning, press "Network > Scan > Stop".
The scanning is stopped and the devices already found are shown in the list.

8. Select the target device whose IP address and device name you want to change. The following figure shows an example.

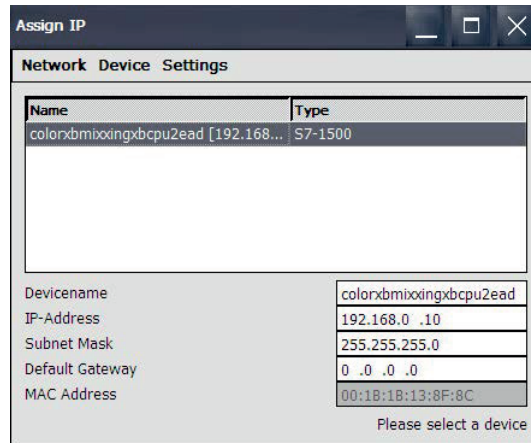

To identify the selected device in the plant, you can use the "Device > Flash" function. The "Flash" function causes the display of the selected HMI device or the "RUN/STOP" LED of a controller to flash.

To reset the IP address and device name of the target device to factory settings, you use the "Device > Reset to Factory" function. This function can only be run if it is supported by the target device and permitted by its security settings.

9. Make the desired changes in the entry fields.
10. Transfer the data to the target device using "Device > Download" and one of the following options.
- "IP": The IP address on the target device is updated.
 - "Device name": The device name of the target device is updated.
 - "All": The IP address and device name of the target device are updated.

A status message is output at the bottom right indicating whether the update was successful.

Configuring a communication connection

If you have changed one or more IP addresses of controllers using the "Assign IP" function, you must then adapt the associated configured connections so that your device can communicate with the controller. You do this using the "Set Connection" function.

Requirement

- The Control Panel is open.
- For HMI devices, the following applies: The project that runs on the target device is closed.
- For controllers, the following applies:
 - The controller is of type S7-1200 or S7-1500.
 - HMI access is allowed in the settings.
 - The controller is in "STOP" state.
- Your system administrator has provided you with the necessary information.

Procedure

The communication connection can only be configured for S7-1200 and S7-1500 controllers.

1. Open the "Service & Commissioning" dialog using the "Service & Commissioning" icon.
2. Change to the "IP Config" tab.

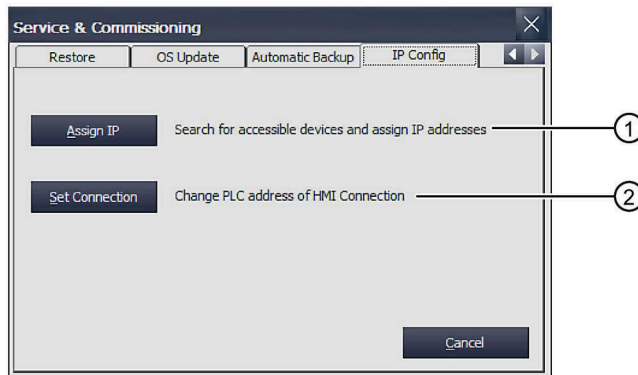

- ① Button for changing IP address and device name
- ② Button for changing the configured communication connections

3. Open the "Set Connection" dialog using the "Set Connection" button.

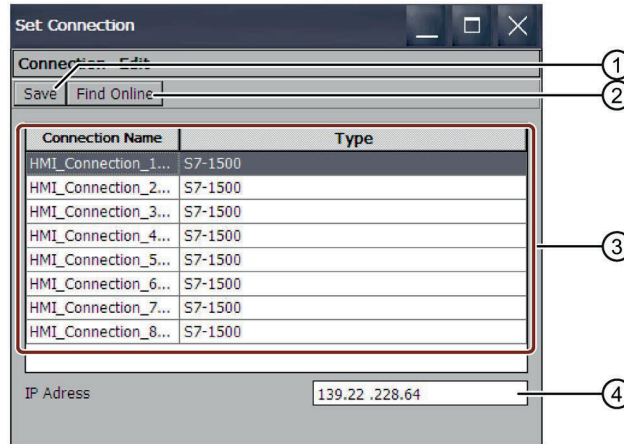

- ① Save setting
- ② Selected communication connection
- ③ List of configured communication connections
- ④ Text box for the IP address

The following functions are available in the menu bar of this dialog:

Menu	Submenu/Entry	Function	
Connection	Save	Saves the selected connection parameters	
	Exit	Close the "Set Connection" dialog	
Edit	Find Online	Find controllers in the subnet of your HMI device	
	Restore to Project	Selected PLC	Overwrite IP address of the selected device with the IP address from the project.
		All	Update IP address and device name of the selected controller

4. Press the "Find Controller" button.
The configured communication connections are listed in the "Connection Name" column. Under "Type", you will find the corresponding S7-1200 or S7-1500 controller. Select the controller to which you want to establish the communication connection.
The message "No connection available in ProjectSettings.hsf data." is displayed:
- If no project has been loaded
 - If there is no communication connection to an S7-1200/S7-1500 in the project
5. If the IP address is to be changed, select the relevant communication connection.
The corresponding IP address is displayed in the "IP address" field.
6. Enter the required IP address in the "IP address" text box.
7. Select "Save".
The change is saved.
8. Confirm with "OK".
The dialog closes.

9. Restart the HMI device.

The communication connection is configured.

See also

Communication with controllers (Page 232)

4.3.12 Uninterruptible power supply

4.3.12.1 Setting the uninterruptible power supply

An uninterruptible power supply (UPS) ensures that the HMI device is shut down in a controlled manner after a configurable buffer time in the event of a power failure. This avoids the loss of data. Connect the UPS to the USB port of the HMI device. You can also configure a message or the controlled shutdown of the HMI device when the UBS port is faulty.

SITOP DC UPS modules with a rated current of 6 A or more are supported as uninterruptible power supplies.

Requirement

- The Control Panel is open.
- A UPS is connected to the 24 V DC connection and the USB port of the HMI device.
- The "Uninterruptable Power Supply (UPS) with USB support" option was transferred to the HMI device with ProSave.

Procedure



1. Open the "UPS Properties" dialog using the "UPS" icon.
2. Change to the "Configuration" tab.

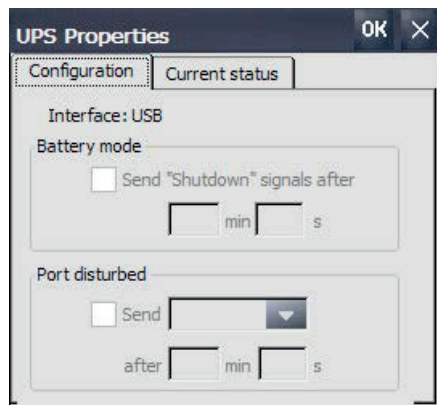

3. If a controlled shutdown of the HMI device is to be performed following interruption of the power supply:
 - Select the check box in the "Battery mode" area.
 - Under "min" and "s", enter the time after which the active project on the HMI device is automatically closed.

NOTICE**Undefined device status if UPS buffer time is insufficient**

If the UPS used cannot sustain the power supply for the configured time period, the HMI device is not shut down in a controlled manner. This may result in damage to the HMI device.

Make sure that the UPS employed can sustain the power supply over the set time period.

4. If the port to which the UPS is connected is faulty and the HMI device is supposed to respond:
 - Select the check box in the "Port disturbed" area.
 - Under "min" and "s", enter the time after which the message is displayed or the active project on the HMI device is automatically closed.
5. Confirm your entries with "OK".
Port monitoring for the UPS is set.

See also

State of the uninterruptible power supply (Page 160)

Connecting the power supply (Page 49)

4.3.12.2 State of the uninterruptible power supply

If you have connected a UPS to a USB port of the HMI device, you can display the monitoring status of this port.

Requirement

- The Control Panel is open.
- A UPS is connected to the 24 V DC connection and the USB port of the HMI device.
- The "Uninterruptable Power Supply (UPS) with USB support" option was transferred to the HMI device with ProSave.
- UPS settings are configured.

Procedure



1. Open the "UPS Properties" dialog using the "UPS" icon.
2. Change to the "Current status" tab.

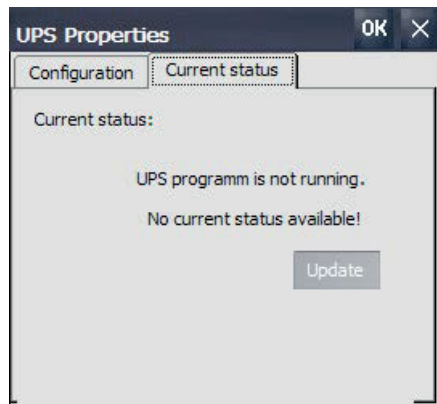

3. Refresh the monitoring status with "Update", if needed.
4. Confirm your entries with "OK".

The current monitoring state for the UPS is displayed.

See also

Setting the uninterruptible power supply (Page 158)

Commissioning a project

5.1 Overview

Configuration phase

A project – the process image of the working process – is produced during configuration to visualize automated working processes. The process displays for the project contain displays for values and alarms which provide information about process statuses. The process control phase follows the configuration phase.

Process control phase

The project must be transferred to the HMI device if it is to be used in process control. Another prerequisite for process control is that the HMI device is connected online to a controller. Current working processes - operating and observing - can then be subject to process control.

Transferring the project to the HMI device

You can transfer a project to an HMI device as follows:

- Transfer from a configuration PC or from an external storage medium
- Restore from a PC using ProSave
In this case, a backed up project is transferred from a PC to the HMI device. The configuration software does not have to be installed on this PC.
- Insert a system memory card containing data from an HMI device of the same type
You can find more information under "Using automatic backup (Page 148)"
- Restore a backup/restore file of an external storage medium from an HMI device of the same type (Restore)

Commissioning and recommissioning

Initial commissioning and recommissioning differ in the following respects:

- During initial commissioning, there is still no project on the HMI device. The HMI device also has this state after update of the operating system.
- When recommissioning, any project already on the HMI device is replaced.

5.2 Operating modes

Operating modes

The HMI device may be in the following operating modes:

- Offline
- Online
- Transfer

Changing the operating mode

The configuration engineer must have configured an appropriate operating element to allow a change of the operating mode on the HMI device during ongoing operation.

Refer to your system documentation to find any additional information on this topic.

"Offline" operating mode

In this mode, there is no communication between the HMI device and the controller. Even though the HMI device can be operated, it cannot exchange data with the controller.

"Online" operating mode

In this mode, the HMI device and the controller communicate with each other. You can operate the system on the HMI device according to your system configuration.

"Transfer" mode

In this mode, you can transfer a project from the configuration PC to the HMI device or backup and restore HMI device data, for example.

The following options are available for setting "Transfer" mode on the HMI device:

- When the HMI device starts up
Start "Transfer" mode manually in the HMI device Start Center.
- During ongoing operation
Start the "Transfer" mode manually within the project using an operating element. The HMI device toggles to "Transfer" mode when automatic mode is set and a transfer is initiated on the configuration PC.

5.3 Using existing projects

To use an existing WinCC flexible project in WinCC, migrate the project to WinCC.

To convert the project of a Comfort V1/1.1 device to a Comfort V2 device, use WinCC (TIA Portal) V14 SP1 or later and switch the HMI device in WinCC.

You can find more information on this topic in the WinCC online help.

See also

Migration of plants to SIMATIC (TIA Portal) Visualization
(<https://support.industry.siemens.com/cs/ww/en/view/76878921>)

5.4 Data transmission options

The following table shows the options for data transmission between an HMI device and the configuration PC.

Type	Data channel to PC	HMI device
Backup	MPI/PROFIBUS DP	Yes
	USB type mini B	Yes
	PROFINET ¹	Yes
	Ethernet	Yes
Restoring	MPI/PROFIBUS DP	Yes
	USB type mini B	Yes
	PROFINET ¹	Yes
	Ethernet	Yes
Updating the operating system	MPI/PROFIBUS DP	Yes
	USB type mini B	Yes
	PROFINET ¹	Yes
	PROFINET, with reset to factory settings ¹	Yes
	Ethernet	Yes
Transferring a project	MPI/PROFIBUS DP	Yes
	USB type mini B	Yes
	PROFINET ¹	Yes
	Ethernet	Yes
Installing or removing an add-on	MPI/PROFIBUS DP	Yes
	USB type mini B	Yes
	PROFINET ¹	Yes
	Ethernet	Yes
License key transferring or transferring back	MPI/PROFIBUS DP	Yes
	USB type mini B	Yes
	PROFINET ¹	Yes
	Ethernet	Yes

¹ Select "PN/IE" as the access point

5.5 Transferring a project with WinCC

5.5.1 Configuring data channel and setting transfer mode

Requirement

- The project on the HMI device is complete.

Procedure

1. Proceed as described in the section "Configuring transfer (Page 99)".
2. Set the operating mode "Transfer" in the "Start Center".

5.5.2 Starting the transfer

For a project to run on the HMI device, the project must be transferred to the HMI device from the configuration PC. With a transfer, you particularly specify whether to overwrite existing data on the HMI device such as "User management" or "Recipe data".

Note

- You can transfer a single project using the configuration software or using Pack&Go . On HMI devices with an HMI device image that is compatible with WinCC (TIA Portal) V14 or higher, you can also transfer an individual project using an external storage medium.
 - With automatic transfer, the HMI device only switches to "Transfer" mode automatically if the project is running on the HMI device.
 - If automatic transfer is activated on the HMI device and a transfer is initiated on the configuration PC, the project currently running is automatically closed.
-

Automatic transfer

Automatic transfer is particularly suited for the test phase of a new project because transfer is remote controlled. When automatic transfer is activated, the HMI device automatically switches to "Transfer" mode as soon as a project transfer is started on a connected configuration PC.

Requirement

- The project to be transferred has been opened in WinCC.
- The project tree is displayed.
- The configuration PC is connected to the HMI device.
- Transfer mode is set on the HMI device.

Procedure

1. Select the "Download to device > Software" command in the shortcut menu of the HMI device.
2. When the "Extended download to device" dialog opens, configure the "Transfer settings". Make sure that the "Transfer settings" match the "Transfer settings on the HMI device":
 - Select the "Ethernet" protocol.
With Ethernet or PROFINET you can also configure the network address in the "Devices & Networks" editor in WinCC. You can find more information on this topic in the online help of WinCC (TIA Portal).
 - Configure the corresponding interface parameters on the configuration PC.
 - Make the specific interface or protocol settings on the HMI device as required.
 - Click "Download".

You can open the "Extended download to device" dialog at any time using the menu command "Online > Extended download to device...".

The "Load Preview" dialog opens. The project is compiled at the same time. The result is displayed in the "Load Preview" dialog.

3. Check the displayed default settings and change them, if necessary.
4. Click "Download".

The project is transferred to the selected HMI device. If errors or warnings occur during the transfer, alarms are displayed in the Inspector window under "Info> Download".

When the transfer is completed successfully, the project is executable on the HMI device.

NOTICE

Deactivating automatic transfer

If you do not deactivate automatic transfer after the commissioning phase, the HMI device can be inadvertently switched to transfer mode. The transfer mode can trigger unintentional reactions in the system.

Deactivate automatic transfer and lock access to the transfer settings. Assign a password in the Control Panel. This locks access to the "Transfer Settings" dialog and prevents unauthorized changes.

5.5.3 Testing a project

The options for testing a project are as follows:

- Test the project on the configuration PC
You can test a project on a configuration PC, using a simulator. You can find detailed information on this in the online help of WinCC (TIA Portal).
- Offline testing of the project on the HMI device
Offline testing means that communication between the HMI device and the controller is down while the test is being carried out.
- Online testing of the project on the HMI device
Online testing means that the HMI device and the controller communicate with each other during testing.

Perform the tests, starting with the "Offline test", followed by the "Online test".

Note

You should always test the project on the HMI device on which the project will be used.

The test increases the certainty that the project will run error-free on the HMI device.

Requirement

- The project has been transferred to the HMI device.
- The HMI device is in "Offline" mode for the offline test.
- The HMI device is in "Online" mode for the online test.

Procedure

Offline test

In "Offline" mode, you can test individual project functions on the HMI device without them being affected by the controller. Controller tags, therefore, are not updated.

- Test the operating elements and visualization of the project as far as possible without connection to the controller.

Online test

In "Online" mode, you can test individual project functions on the HMI device without them being affected by the controller. Controller tags are updated in this case. You have the option to test all communication-related functions, such as alarms, etc.

- Test the operating elements and views of the project.
 - Check that the screens are correctly displayed.
 - Check the screen navigation.
 - Check the input objects.
 - Enter tag values.

5.6 Backup and restore

5.6.1 Overview

Backup and restore

A data backup saves the contents of the internal memory in a backup/restore file (.brf) on a configuration PC or on an external storage medium. The backup/restore file does not contain alarm logs and process value logs. These logs are saved separately on an external storage medium. Back up these logs manually if required. If the HMI device is integrated in a network, you can also back up the data on a network drive.

The following data is backed up in the backup/restore file:

- Project and HMI device image
- User administration
- Recipe data
- License keys

Use WinCC for backup and restore on a configuration PC.

General information

Note**Power failure**

If a complete restore operation is interrupted due to power failure on the HMI device, the operating system of the HMI device may be deleted. In this case, you have to reset the HMI device to its factory settings. The HMI device automatically switches to "bootstrapping" mode.

Note**Compatibility conflict**

If an alarm is output on the HMI device warning of a compatibility conflict during the restore operation, the operating system must be updated.

5.6.2 Backing up and restoring data of the HMI device

Note

Use the restore function only for project data on HMI devices that were configured with the same configuration software.

Requirement

- The HMI device is connected to the configuration PC.
- The HMI device is selected in the project tree.
- If a server is used for data backup: The configuration PC has access to the server.

Backing up data of the HMI device

To back up the data of the HMI device, follow these steps:

1. Select the "Backup" command in the "Online > HMI device maintenance" menu.
The "SIMATIC ProSave" dialog opens.
2. Under "Data type", select which data of the HMI device should be saved.
3. Under "Save as", enter the name of the backup file.
4. Click "Start Backup".

This starts the data backup. The backup process can take time, depending on the connection selected.

Restoring data of the HMI device

To restore the data of the HMI device, follow these steps:

1. Select the "Restore" command in the "Online > HMI device maintenance" menu.
2. Under "Opening...", enter the name of the backup file.
Information about the selected backup file is displayed under "Content".
3. Click "Start Restore".

This starts the restoration. This process can take time, depending on the connection selected.

Backup/Restore via "Backup/Restore" dialog in the HMI device Control Panel

The "Backup/Restore" function is approved for MMC and SD memory cards as well as USB storage media.

5.7 Updating the operating system

5.7.1 Updating the operating system

Introduction

If the operating system version of an HMI device is not compatible with the configuration, you need to update the operating system of the HMI device. Depending on the protocol used, the operating system on the HMI device is updated automatically upon prompting when the project is loaded. Thereafter, the loading continues. Otherwise, the loading of the project is canceled. In this case, you have to start the update of the operating system manually.

Updating the operating system

To update the operating system of an HMI device, connect the HMI device to the configuration PC. If possible, use the interface with the highest bandwidth, such as Ethernet, to make this connection.

"Reset to factory settings"

If the operating system on the HMI device is no longer functional, update your operating system and restore the factory settings on the HMI device. If the HMI device detects the fault itself, the HMI device automatically restarts in "bootstrapping" mode and issues a corresponding message.

5.7.2 Updating the operating system of the HMI device

If possible, use the interface with the highest bandwidth, such as Ethernet, to make the connection.

NOTICE

Updating the operating system deletes all data on the HMI device

If you update the operating system, data on the target system is deleted. Therefore, first back up the following data:

- User administration
- Recipes

A reset to the factory settings also deletes the license keys. Back up the license keys as well before restoring the factory settings.

NOTICE

Automatic backup and updating the operating system

When the "Automatic backup" function is activated while the operating system is being updated, the HMI device may not start up again correctly.

If you want to update the operating system of the HMI device and have activated the "Automatic backup" function, follow these steps:

1. Deactivate the "Automatic backup" function.
2. Update the operating system.
3. Activate the "Automatic backup" function.

Leave the system memory card in the HMI device before and during the entire operating system update.

Note

Calibrating the touch screen

After the update, you may have to recalibrate the touch screen.

Requirement

- The HMI device is connected to the configuration PC.
- The PG/PC interface is set.
- The HMI device is selected in the project tree.
- The HMI device is switched on.

Updating the operating system

The configuration settings from "Devices & Networks" are used to establish a connection between the HMI device and the configuration PC.

To update the operating system, follow these steps:

1. Select the "Update operating system" command in the "Online > HMI device maintenance" menu.
The "SIMATIC ProSave [OS-Update]" dialog box opens. The path to the image of the operating system is already set.
2. If needed, select another path for the operating system image that you wish to transfer to the HMI device.
3. Click "Update OS".

This starts the update. The update operation can take time, depending on the connection selected.

The HMI device is reset to the factory settings.

To restore the factory settings on the HMI device, follow these steps:

1. Set the HMI device to "bootstrapping" mode.
 - Open the "OP Properties" dialog on the HMI device in the Control Panel.
 - Switch to the "Device" tab and select "Reboot".

The "Attention" dialog box opens.

 - Select "Prepare for Reset".

The HMI device restarts and switches to "bootstrapping" mode. If you do not reset the HMI device to the factory settings, the HMI device restarts after 10 minutes.
2. Select the "Update operating system" command in the "Online > HMI device maintenance" menu on the configuration PC in WinCC.

The "SIMATIC ProSave [OS-Update]" dialog box opens. The path to the image of the operating system is already set.
3. If needed, select another path for the operating system image that you wish to transfer to the HMI device.
4. Enable "Reset to factory settings".
5. Enter the MAC address of the HMI device.
6. Click "Update OS".

The operation can take some time.

Result

The operating system of the HMI device is now operational and updated to the latest version.

5.8 Managing add-ons and license keys

5.8.1 Managing add-ons

Introduction

You can install the following add-ons on an HMI device:

- Add-ons supplied with WinCC
- Add-ons purchased separately from WinCC

The HMI device type determines which add-ons can be installed.

For an overview of available add-ons, refer to "Introduction to WinCC".

Requirement

- The HMI device is connected to the configuration PC.
- The PG/PC interface is set.
- The HMI device is selected in the project tree.
- The HMI device is switched on.

Procedure

To install an add-on on the HMI device, follow these steps:

1. Select the "Options" command in the "Online > HMI device maintenance" menu.
All available add-ons and those already installed are shown.
2. You may also click "Device status" to display the add-ons installed on the HMI device.
3. To install an add-on on the HMI device, select the add-on and use ">>" to transfer it to the list of installed add-ons.
4. Click "<<" to remove an add-on from the HMI device.
5. To start the installation or removal, click "OK".

Result

The selected add-ons have been installed on the HMI device or removed from the HMI device.

See also

Transferring license keys (Page 173)

5.8.2 Transferring license keys

Introduction

You need a license key for WinCC Runtime add-ons to use them on an HMI device. The required licenses are usually supplied as license keys on a data medium, for example, a USB stick. You can also obtain the license keys from a license server.

Use the "Automation License Manager" to transfer the license keys to or from an HMI device. The "Automation License Manager" is installed automatically with WinCC.

NOTICE

Backing up license keys

To prevent the deletion of the license keys, you need to back them up in the following situation:

- Prior to restoring a complete database from the backup copy

See also

Managing add-ons (Page 172)

5.8.3 Managing license keys

Requirement

- The HMI device is connected to the configuration PC or to the PC with the "Automation License Manager".
- If you use the configuration PC: The HMI device is selected in the project tree.

Procedure

To transfer the license keys, follow these steps:

1. Open the "Automation License Manager". On a PC without a WinCC installation, open the "Automation License Manager" from the Windows Start menu.

The "Automation License Manager" starts.

2. Select the "Connect HMI device" command in the "Edit > Connect Target System" menu.

The "Connect target system" dialog opens.

3. Select the "device type" of your HMI device.

4. Select the "connection".

5. Configure the corresponding "connection parameters", depending on the selected connection.

6. Click "OK".

The connection to the HMI device is established. The connected HMI device is displayed in the left area of the "Automation License Manager".

7. Transfer the license keys to the HMI device:

- In the left area, select the drive on which the license keys are located.

The license keys are shown in the right area.

- Select the license keys.
- Drag-and-drop the license keys to the HMI device.

You can also remove license keys from the HMI device by means of drag-and-drop.

Alternative procedure

On a PC with a WinCC installation, you can also launch the "Automation License Manager" from WinCC: Select the "Authorize/License" command in the "Online > HMI device maintenance" menu.

Result

The license keys are transferred to the HMI device.

To back up the license keys on the HMI device, drag them from the HMI device to an available drive.

Operating a project

6.1 Overview

Operator input options

The hardware of the HMI device determines which of the following operator control options are available:

- Touch screen
The operating elements shown in the dialogs are touch-sensitive. They are basically operated in the same way as mechanical keys. You activate operating elements by touching them with your finger. To double-click them, touch an operating element twice in succession.
- HMI device keyboard
The operating elements shown in the screens are selected and operated using the keys of the HMI device.
- External keyboard, connected via USB
- External mouse, connected via USB

 **CAUTION**

Damage to the touch screen

Do not touch the touch screen with pointed or sharp objects. Otherwise, you can damage the plastic membrane of the touch screen.

Do not apply excessive pressure to the touch screen with hard objects, and avoid continuous operation with gestures. Both will substantially reduce the service life of the touch screen and can even lead to total failure.

The following paragraphs provide instructions for operating a project with the touch screen and the keyboard.

Operating a project with an external keyboard

An external keyboard can be used to operate a project in exactly the same way as with the HMI keyboard or screen keyboard.

Note

The function keys of the external keyboard are disabled.

Operating a project with an external mouse

The project can be operated with an external mouse in exactly the same way as with the HMI touch screen. Click the described operating elements with the mouse.

Unintentional actions



CAUTION

Unintentional reactions to simultaneous operations

Do not carry out several operations simultaneously. Otherwise, you may trigger unintentional reactions.

- With touch control:

Touch only one operating element on the screen at a time.

- With key control:

Do not press more than two function keys at the same time.

Exception: The keyboard shortcut <CTRL+ALT+DEL> can also be used with the system keys. Note that the "Lock Task Switching" option can be activated in the project in the Runtime settings of the HMI device.

Observing the system documentation

Some operations with the project may require in-depth knowledge about the specific system on the part of the operator. If you use jog mode, for example, proceed with care. Refer to your system documentation to find any additional information on this topic.

Operation feedback from operating elements

The HMI device provides operation feedback as soon as it detects that an operating element has been selected. This operation feedback is independent of any communication with the controller. Therefore, this operation feedback does not indicate whether the relevant action is actually executed or not.

Optical feedback from operating elements

The operating element receives the focus and is selected. The configuration engineer can also configure the selection of an operating element so that it deviates from the standard. Refer to your system documentation to find any additional information on this topic.

The type of optical feedback depends on the operating element:

- Buttons

The HMI device generates different views for the "Pressed" and "Unpressed" states, provided the configuration engineer has configured a 3D effect:

- "Pressed" state:



- "Unpressed" state:



The configuration engineer determines the appearance of a selected field, for example, line width and color for the focus.

- Invisible buttons

By default, invisible buttons are not displayed as pressed when they are touched. No optical operation feedback is provided in this case.

The configuration engineer may, however, configure invisible buttons so that their outline appears as lines when touched. This outline remains visible until you enable another operating element.

- I/O fields

When you select an I/O field, the content of the I/O field is displayed against a colored background. With touch operation, a screen keyboard opens for entering values.

Acoustic feedback from operating elements

An acoustic signal is generated as soon as the HMI device detects that the touch screen has been touched or a key has been pressed. You can activate or deactivate this acoustic operation feedback.

Note

The acoustic feedback is only possible if you interact with the project directly on the touch screen or press one of the keys of the HMI device. If you use an external mouse or keyboard for interaction, no acoustic signal is issued.

Acoustic feedback does not mean that the action has been performed.

Acoustic signal for inadvertent operations

If you try to enter an invalid character, the HMI device issues an acoustic signal in accordance with the setting.

6.2 Function keys

Function keys

Function key assignment is defined during configuration. The configuration engineer can assign function keys globally and locally.

Function keys are available only on key HMI devices.

Function keys with global function assignment

A globally assigned function key always triggers the same action on the HMI device or in the controller regardless of the screen displayed. Such an action could be, for example, the activation of a screen or the closure of an alarm window.

Function keys with local function assignment

A function key with local function assignment is screen-specific and is therefore only effective within the active screen.

The function assigned locally to a function key can vary from screen to screen.

The function key of a screen can be assigned one function only, either a global or local one. The local assignment function takes priority over the global setting.

The configuration engineer can assign function keys in such a way that you can manipulate operating elements with function keys, for example, the alarm view, trend view, recipe view or status/force.

6.3 Direct keys

Introduction

Direct keys on the HMI device are used to set bits in the I/O area of a SIMATIC S7.

Direct keys enable operations with short reaction times that are, for example, a jog mode requirement.

Note

Direct keys are still active when the HMI device is in "offline" mode.

Note

If you operate a function key with direct key functionality in a running project, the direct key function is always executed, independent of the current screen contents.

Note

You can only use direct keys when there is a connection by means of PROFIBUS DP or PROFINET IO.

Direct keys result in additional basic load on the HMI device.

Note**Direct key LEDs**

If keys of the HMI device that are equipped with an LED are used as direct keys over PROFINET IO, the following applies:

- After the device is switched on, the LEDs of the direct keys do not light up.
 - As soon as the PROFINET IO connection is established, the LEDs of the direct keys light up.
 - If no direct key communication exists or a PROFINET IO communication error occurs, e.g. due to faulty check bits, the LEDs of the direct keys are no longer lit.
-

Direct keys

The following objects can be configured as a direct key:

- Buttons
- Function keys

You can also define image numbers in the case of HMI devices with touch operation. In this way, the configuration engineer can configure the direct keys on an image-specific basis.

You can find detailed information on configuring direct keys in the online help for WinCC under "Visualizing processes > Communicating with controllers".

6.4 Setting the project language

Introduction

The HMI device supports multilingual projects. You must have configured a corresponding operating element which lets you change the language setting on the HMI device during runtime.

The project always starts with the language set in the previous session.

Requirement

- The required language for the project must be available on the HMI device.
- The language switching function must be logically linked to a configured operating element, such as a button.

Selecting a language

You can change project languages at any time. Language-specific objects are immediately output to the screen in the new language when you switch languages.

The following options are available for switching the language:

- A configured operating element switches from one language to the next in a list
- A configured operating element directly sets the desired language

Refer to your system documentation to find any additional information on this topic.

6.5 Input of values

If you select an I/O field in the project using the tab sequence or by touch, the entire field content is selected. The screen keyboard appears on a touch HMI device.

Procedure

Proceed as follows:

1. To overwrite the value:
 - Enter the new value using the system keys or the screen keyboard.
2. To change the value:
 - Key HMI device: Deselect the content with <SHIFT+Right>.
 - Touch HMI device: Deselect the content with any cursor key.
 - Move the cursor to the desired location and change the value.
3. Close the value entry.

Result

The value of the I/O field is set.

See also

Entering and editing numerical values (Page 181)

Entering or changing alphanumeric values (Page 182)

Entering values with system keys (Page 75)

Reference for system keys (Page 71)

6.6 Entering and editing numerical values

Introduction

You enter numerical values depending on a type of HMI device, either with the system keys or the screen keyboard. You can also connect an external keyboard.

Note

When the screen keyboard is open, job mailbox 51, "Select screen" has no function.

- With key HMI devices, only the numbers on the system keys are available.
- With touch HMI devices, a numerical screen keyboard opens.

Date and time

Date and time are entered in the same way as numerical values.

Note

When entering the date and time, note that their format is determined by the configured project language.

Entering hexadecimal values

If the configuration engineer has configured the I/O field as "Hexadecimal display", the letters "A" to "F" are available in addition to the numbers.

With touch devices, the alphanumeric screen keyboard appears in this case. The keys "G" to "Z" are not used. When you press the keys, a beep is emitted.

Limit test of numerical values

Tags can be assigned limits. If you enter a value outside these limits it will not be accepted, for example, "80" is rejected if the configured limit is "78". When an alarm window is configured, a system alarm is generated on the HMI device. Regardless of this, the original value is displayed again.

Decimal places for numerical values

The configuration engineer can specify the number of decimal places for a numerical text box. The number of decimal places is checked when you enter a value in this type of I/O field.

- Decimal places in excess of the limit are ignored.
- Empty decimal places are filled with "0".

Requirement

Cursor is in an I/O field.

Procedure

Proceed as follows:

1. Enter the desired value using the system keys or the screen keyboard.
2. Discard the entry with <ESC>, if necessary.
3. Conclude your entry with <ENTER>.

Result

The numerical value has been changed. If you have discarded the entry, the I/O field remains empty or the original value is displayed.

See also

Input of values (Page 180)

Entering values with system keys (Page 75)

Reference for system keys (Page 71)

6.7 Entering or changing alphanumeric values

Introduction

Depending on the type of HMI device, you enter alphanumeric values either with the system keys or the screen keyboard. You can also connect an external keyboard.

Note

When the screen keyboard is open, job mailbox 51, "Select screen" has no function.

- With key HMI devices, all characters on the system keys are available.
 - With touch HMI devices, an alphanumeric screen keyboard opens.
-

Note

The screen keyboard display is independent of the configured project language.

Requirement

Cursor is in an I/O field.

Procedure

Proceed as follows:

1. Enter the desired value using the system keys or the screen keyboard.
2. Discard the entry with <ESC>, if necessary.
3. Conclude your entry with <ENTER>.

Result

The alphanumeric value has been entered or changed. If you have discarded the entry, the I/O field remains empty or the original value is displayed.

See also

Input of values (Page 180)

Entering values with system keys (Page 75)

Reference for system keys (Page 71)

6.8 Displaying infotext

The configuration engineer uses infotexts to provide additional information and operating instructions. The configuration engineer can configure infotexts on screens and operating elements.

The infotext of an I/O field may contain, for example, information on the value to be entered.

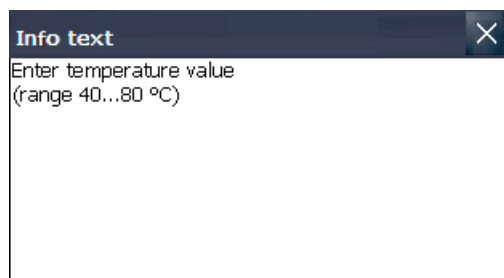

If an infotext is configured for an operating element, the infotext is displayed on the HMI device as follows:

- With touch devices, the <Help> key is shown in the screen keyboard.



- With key HMI devices, the LED of the <HELP> key lights up.



Requirement

Operating element with the configured infotext is selected.

Procedure

Proceed as follows:

1. Press the <HELP> key.
The infotext for the operating element is displayed.
2. Use the cursor keys to scroll as needed.

Note

Switching between displayed infotext

The configuration engineer can configure infotext for an I/O field and the associated screen. You can switch between two infotexts by touching the infotext window.

3. Close the window with the infotext.

Alternative procedure

Depending on your configuration, infotext can also be called by means of a configured operating element.

Refer to your system documentation to find any additional information on this topic.

6.9 Closing the project

Procedure

Proceed as follows:

1. Use the corresponding operating element object to close the project. Wait for the Start Center to be displayed.
2. Switch off power to the HMI device.

Maintenance and care

7.1 General information on maintenance and servicing

Observe the following when servicing and repairing protective equipment e.g. such as ground circuits or overvoltage protection components:

- Observe the maintenance and replacement intervals.
- Replace system components, including external cables, fuses and batteries only with equivalent components approved by the respective manufacturer.

7.2 Cleaning the device front

7.2.1 Clean the touch screen and keyboard cover

The HMI device is designed for low-maintenance operation. You should still clean the touch screen and keyboard film regularly.

Observe the information on chemical resistance (<https://support.industry.siemens.com/cs/ww/en/view/39718396>).

Requirement

- Damp cleaning cloth
- Dishwashing liquid or foaming screen cleaning agent

Procedure

Note

Unintentional response

If you clean the touch screen or an HMI device with a keyboard film when it is switched on, you may cause incorrect operator inputs.

Switch off the HMI device or, during ongoing operation, clean the touch screen only when it is in a locked state. Note that the touch screen lock automatically ends after 15 seconds.

Note

Avoid damage to the front

Using compressed air or steam cleaners, or aggressive solutions or scouring agents will damage the HMI device.

Do not clean the HMI device with compressed air or steam jet blowers. Do not use aggressive solvents or scouring powder.

7.2 Cleaning the device front

Proceed as follows:

1. Switch off the HMI device or lock the touch screen.
2. Spray the cleaning solution onto a cleaning cloth.
Do not spray directly onto the HMI device.
3. Clean the HMI device.
When cleaning the display wipe from the screen edge inwards.

7.2.2 Clean screen for Touch HMI devices

The touch screen of the HMI device can be cleaned when it is switched on and a project is running. An operating element must be available in the project that can be used to call the "clean" screen. Once the clean screen is activated, touch screen operation is locked for a configured period of time. The time the touch screen is locked can be set between 5 and 30 seconds. The time remaining for the lockout is indicated by a progress bar.

Note

Unintentional responses

When cleaning the touch screen, an unintentional response in the controller can be triggered by touching keys.

Always open the clean screen or switch off the HMI device before you clean the touch screen while the system is running.

Note

Cannot be operated when the clean screen is active

When the clean screen is active, operations on the HMI device are not possible.

Wait for the period of the clean screen to lapse. Then you can operate the system again with the HMI device.

Note

No clean screen with HMI devices with touch screen and function keys

The clean screen is not available for HMI devices with touch screen and function keys. In this case, configure a screen without operating elements, for example.

7.3 Spare parts and repairs

Repairs

Contact your Siemens representative (<https://www.siemens.com/aspa>). Filter by expertise, product and region.

Your contact person will let you know if a product can be repaired and how to return it.

Contact your representative before returning a product, including when you would like to request prioritized handling of your repair, a cost estimate, a repair report or an examination report.

The representative can also provide information about spare parts, if available.

Spare parts

Spare parts and accessories for the HMI device can be found in section "Accessories (Page 22)".

7.4 Recycling and disposal

Due to the low levels of pollutants in the HMI devices described in these operating instructions, they can be recycled.

Contact a certified disposal service company for electronic scrap for environmentally sustainable recycling and disposal of your old devices and dispose of the device according to the relevant regulations in your country.

Maintenance and care

7.4 Recycling and disposal

www.nicsanat.com

021-87700210



Technical information

8.1 Software license agreements

Microsoft licenses

License fees for the pre-installed Microsoft operating system on the HMI devices are paid directly by Siemens to the Microsoft company.

No COA label ("Certificate of Authenticity") and no other proof of license is required for the HMI device.

Open Source Software

Read the software license agreements for Open Source Software on the supplied "Open Source Software License Conditions" data medium.

8.2 Certificates and approvals

Approvals

Note

The following overview shows possible approvals.

The HMI device itself is approved as shown on the rear panel labels.

CE approval



The devices meet the general and safety-related requirements of the following EU Directives and conform with the harmonized European standards (EN) published in the official gazettes of the European Union and confirmed in the EU declarations of conformity:

- 2014/30/EU "Electromagnetic Compatibility" (EMC Directive)
- 2014/34/EU "Equipment and protective systems for use in hazardous areas" (Explosion protection directive)
- 2011/65/EU "Directive of the European Parliament and of the Council of 8 June 2011 on the restriction of the use of certain hazardous substances in electrical and electronic equipment" (RoHS Directive)

EU Declaration of Conformity

The EU Declarations of Conformity are available to the relevant authorities at the following address:

Siemens AG
Digital Industries
Factory Automation
DI FA TI COS
Postfach 1963
D-92209 Amberg

You can also download these on the Internet using the keyword "Declaration of Conformity" at the following address: Certificates for Comfort Panels
(<https://support.industry.siemens.com/cs/ww/en/ps/14742/cert>)

UKCA marking



The devices fulfil the general and safety-related requirements of the following regulations and related amendments and comply with the designated British standards (BS) published in the official consolidated list of the British Government.

- Electromagnetic Compatibility Regulations 2016 (EMC)
- The Restriction of the Use of Certain Hazardous Substances in Electrical and Electronic Equipment Regulations 2012 (RoHS)

When the device has Ex approval, the following also applies:

- Equipment and Protective Systems Intended for use in Potentially Explosive Atmospheres Regulations 2016 (Explosion Protection)

UK Declarations of Conformity

The UK Declarations of Conformity are available to the relevant authorities at the following address:

Siemens AG
Digital Industries
Factory Automation
DI FA TI COS
P.O. Box 1963
D-92209 Amberg

You can also download these on the Internet using the keyword "Declaration of Conformity" at the following address: Certificates for Comfort Panels
(<https://support.industry.siemens.com/cs/ww/en/ps/14742/cert>)

UL approval

Observe the following information:

- The device shall be supplied from an isolating source, rated 24 VDC.
- Only for use in LAN, not for connection to telecommunication circuits.



7" to 12" devices

Underwriters Laboratories Inc. (E116536)
in accordance with

- UL 61010-1 and UL 61010-2-201
- CAN/CSA C22.2 No. 61010-1 and 61010-2-201

All other devices

Underwriters Laboratories Inc.
in accordance with

- UL 508 (Industrial Control Equipment)
- CAN/CSA C22.2 No. 142 (Process Control Equipment)

or



7" to 12" devices

Underwriters Laboratories Inc. (E222109)
in accordance with

- UL 61010-1 and UL 61010-2-201
- CAN/CSA C22.2 No. 61010-1 and 61010-2-201
- UL 121201 (Hazardous Location)
- CAN/CSA C22.2 No. 213 (Hazardous Location)

All other devices

Underwriters Laboratories Inc.
in accordance with

- UL 508 (Industrial Control Equipment)
- CAN/CSA C22.2 No. 142 (Process Control Equipment)
- ANSI/ISA 12.12.01
- CAN/CSA C22.2 No. 213 (Hazardous Location)

Approved for use in

- Class I, Division 2, Group A, B, C, D T4 or
- Class I, Zone 2, Group IIC T4 or
- non-hazardous locations

Approved for use in

- Class I, Division 2, Group A, B, C, D T4 or
- Class I, Zone 2, Group IIC T4 or
- non-hazardous locations

FM Approval



Factory Mutual Research (FM) conforming to

- Approval Standard Class Number 3611, 3600, 3810
- ANSI/ISA 61010-1
- ANSI/UL 121201
- ANSI/NEMA 250
- CAN/CSA C22.2 No. 0-10
- CAN/CSA-C22.2 No. 94
- CAN/CSA C22.2 No. 213
- CAN/CSA C22.2 No. 61010-1

Approved for use in

- Class I, Division 2, Group A, B, C, D T4
- Class I, Zone 2, Group IIC T4

Installation Instructions for cFMus:

WARNING – Do not remove or replace while circuit is live when a flammable or combustible atmosphere is present.

WARNING – Substitution of components may impair suitability of the equipment.

CAUTION – To prevent injury, read the manual before use.

WARNING – The equipment is intended to be installed within an enclosure/control cabinet. The inner service temperature of the enclosure/control cabinet corresponds to the ambient temperature of the module. Use cables with a maximum permitted operating temperature of at least 20 °C higher than the maximum ambient temperature.

ATEX/UKEX/IECEx approval

Notes on use in hazardous areas

Observe the following FAQ regarding the use of an HMI device in hazardous areas: ATEX-FAQ (<https://support.industry.siemens.com/cs/ww/en/view/291285>)

When using the device in hazardous areas, ensure that all plugs connected to the device are secured in a captive manner, see section "Securing cables for use in hazardous areas (Page 60)".

You can find more information about explosion protection, EC/EU declarations of conformity and other certificates on the Internet at the following address: Certificates for Comfort Panels (<https://support.industry.siemens.com/cs/ww/en/ps/14742/cert>)

ATEX/UKEX approval

For an HMI device with "Ex" marking, the following approvals apply according to the following standards.

- Standards:
 - EN IEC 60079-0
 - EN IEC 60079-7
 - EN 60079-31

- Approvals:

	II 3 G	Ex ec IIC T4 Gc
	II 3 D	Ex tc IIIC T 70 °C Dc

IECEx approval

For an HMI device with "IECEx" marking, the following approvals apply according to the following standards.

- Standards:
 - IEC 60079-0
 - IEC 60079-7
 - IEC 60079-31

- Approvals:

	Ex ec IIC T4 Gc
	Ex tc IIIC T 70°C Dc

CCCEX approval



The following approvals according to the following standards are valid for a device with the "CCC" marking.

- Standards:
 - GB/T 3836.1 (Explosive atmospheres - Part 1: Equipment - General requirements)
 - GB/T 3836.3 (Explosive atmospheres - Part 3: Equipment protection by increased safety "e")
 - GB/T 3836.31 (Explosive atmospheres - Part 31: Equipment dust ignition protection by enclosure "t")
- Approvals:
 - Ex ec IIC T4 Gc
 - Ex tc IIIC T70°C Dc

Special conditions of use

- The front of the HMI device provides a degree of protection of at least IP65.
The front of the HMI device must be installed in a certified enclosure which offers a degree of protection of at least IP54 in accordance with GB/T 3836.1 for Group II, IP54 in accordance with GB/T 3836.1 for Group IIIA and IIIB, and IP6X in accordance with GB/T 3836.1 for Group IIIC.
During use, make allowances for the ambient conditions.
- The equipment shall be installed in such a way that the risk of mechanical danger is low.
- To avoid an electrostatic charge, wipe the enclosure surface with a damp cloth only.
- Expanded inclination and temperature range for TP700/900/1200/1500 Comfort devices, when the following conditions are met:
 - The load on the USB ports does not exceed a total of 100 mA.
 - The +24 V DC connection of the PROFIBUS interface is not used.
 - The relative humidity during operation is 10% to 60%, without condensation.The following mounting positions and temperature ranges are permitted under the specified conditions:
 - Landscape format without inclination at an ambient temperature of up to +55 °C.
 - Landscape format with 40° inclination at an ambient temperature of up to +40 °C.
- When used in an area requiring the use of equipment with EPL Gc, the following additional conditions apply:
 - The equipment shall only be used in an area of not more than pollution degree 2, as defined in GB/T 16935.1.
 - Provisions shall be made to prevent the rated voltage from being exceeded by transient disturbances of more than 119 V.

IEC 61010-2-201/IEC 61131-2

The devices meet the requirements and criteria of the IEC 61010-2-201 and/or IEC 61131-2 standard.

- IEC 61010-2-201, Safety regulations for electrical equipment for measurement, control, and laboratory use: Particular requirements for control equipment
- IEC 61131-2, Programmable controllers: Equipment requirements and testing

RCM AUSTRALIA/NEW ZEALAND



This product meets the requirements of EN 61000-6-4 Generic standards – Emission standard for industrial environments.

KOREA



This product satisfies the requirement of the Korean Certification (KC Mark).

이 기기는 업무용(A급) 전자파 적합기기로서 판매자 또는 사용자는 이 점을 주의하시기 바라며 가정 외의 지역에서 사용하는 것을 목적으로 합니다.

Note that this device conforms to Limit Class A for emission of radio interference. This device can be used in all areas except the residential area.

Eurasian Customs Union marking



EAC (Eurasian Conformity)

- Customs union of Russia, Belarus and Kazakhstan
- Declaration of conformity according to Technical Regulations of the Customs Union (TR CU)

WEEE label (European Union)



Disposal instructions, observe the local regulations and the section "Recycling and disposal (Page 187)".

Marine approvals

The following marine approvals are provided for the device.

- ABS (American Bureau of Shipping)
- BV (Bureau Veritas)
- DNV (Det Norske Veritas)
- LRS (Lloyds Register of Shipping)
- RINA (Registro Italiano Navale)
- Class NK (Nippon Kaiji Kyokai)
- KR (Korean Register of Shipping)
- CCS (China Classification Society)

After successful acceptance, the certificates are available on the Internet at the following address:

Certificates for Comfort Panels

<http://support.automation.siemens.com/WW/view/en/47182890/134200>

8.3 Electromagnetic compatibility

The HMI device satisfies, among other things, the requirements of the EMC guidelines of the European domestic market.

EMC-compatible installation of the HMI device

The EMC-compliant installation of the HMI device and the application of interference-proof cable is the basis for interference-free operation.

Observed the following manuals in addition to these operating instructions:

- Designing interference-free controllers
(<https://support.industry.siemens.com/cs/ww/en/view/59193566>)
- Industrial Ethernet / PROFINET - Passive network components
(<https://support.industry.siemens.com/cs/ww/en/view/84922825>)
- PROFIBUS networks (<https://support.industry.siemens.com/cs/ww/en/view/1971286>)

Pulse-shaped disturbance

The following table shows the electromagnetic compatibility of modules with regard to pulse-shaped interference. The precondition for electromagnetic compatibility is that the HMI device meets the specifications and guidelines for electrical installation.

Pulse-shaped interference	Tested with	Performance level equivalence
Electrostatic discharge in accordance with IEC 61000-4-2	Air discharge: 8 kV	3
	Contact discharge: 6 kV (front)	
	Contact discharge: 4 kV (rear)	2
Bursts (high-speed transient interferences) in accordance with IEC 61000-4-4	2 kV supply cable 1 kV signal line, < 30 m	3
	2 kV signal line, > 30 m	4
High-energy single pulse (surge) in accordance with IEC 61000-4-5 ¹	Asymmetrical coupling (line to ground):	
	• 1 kV supply cable, DC voltage	2
	• 1 kV signal line/data cable, > 30 m	
	Symmetrical coupling (line to line):	
	• 0.5 kV power cable, DC voltage	2
• 1 kV signal line, > 30 m	3	

¹ The following applies to Comfort V1/V1.1 devices: External protective circuit required, see Function Manual "Designing interference-free controllers", section 7 "Lightning protection and overvoltage protection"

You can find the Function Manual "Designing interference-free controllers" for download on the Internet (<https://support.industry.siemens.com/cs/ww/en/view/59193566>).

Sinusoidal interference

The following table shows the EMC behavior of the modules with respect to sinusoidal interference. This requires the HMI device to meet the specifications and directives for electrical installation.

Sinusoidal interference	Test values
HF radiation (electromagnetic fields) according to IEC 61000-4-3	Comfort V1/V1.1 devices: 80% amplitude modulation at 1 kHz <ul style="list-style-type: none"> • to 10 V/m from 80 MHz ... 1 GHz • to 10 V/m from 1.4 GHz ... 2 GHz • to 1 V/m from 2 GHz ... 2.7 GHz
	Comfort V2 devices: 80% amplitude modulation at 1 kHz <ul style="list-style-type: none"> • To 10 V/m in the range 80 MHz to 1 GHz • To 3 V/m in the range 1.4 GHz to 6 GHz
HF current feed on cables and cable shields according to IEC 61000-4-6	Test voltage 10 V with 80% amplitude modulation at 1 KHz in the 10 KHz to 80 MHz range
Magnetic field intensity	50/60 Hz; 100 A/m RMS

Emission of radio interference

The following table shows the interference emission from electromagnetic fields according to EN 61000-6-4, measured at the following distance.

Radiated emission (emitted interference)

Frequency range	Measuring distance	Interference emission
30 ... 230 MHz	10 m	< 40 dB ($\mu\text{V/m}$) quasi-peak
230 ... 1000 MHz	10 m	< 47 dB ($\mu\text{V/m}$) quasi-peak
1 ... 3 GHz	3 m	< 76 dB peak and < 56 dB average
3 ... 6 GHz	3 m	< 80 dB peak and < 60 dB average

Emission of radio interference voltages

Frequency range	Interference emission
0.150 ... 0.5 MHz	< 79 dB quasi-peak and < 66 dB average
0.5 ... 30 MHz	< 73 dB quasi-peak and < 60 dB average

See also

EMC information in section "Notes about usage (Page 29)".

8.4 Mechanical ambient conditions

8.4.1 Storage conditions

The following information is for a device that is transported and stored in its original packaging.

The device was tested according to IEC 60721-3-2:2018 Class 2M4 with the following amendments and limitations:

Type of condition	Permitted range
Free fall	≤ 0.3 m
Vibration according to IEC 60068-2-6	5 .. 8.4 Hz, deflection 3.5 mm 8.4 ... 500 Hz, acceleration 1 g
Shock according to IEC 60068-2-27	250 m/s ² , 6 ms, 1000 shocks

8.4.2 Operating conditions

The following information applies to a device installed according to the specifications in these operating instructions.

The device was tested based on IEC 60721-3-3:2002 Class 3M3 with the following amendments and limitations:

Type of condition	Permitted range
Vibration according to IEC 60068-2-6	5 ... 8.4 Hz, deflection 3.5 mm 8.4 ... 200 Hz, acceleration 1 g
Shock according to IEC 60068-2-27	150 m/s ² , 11 ms, 3 shocks

Shock pulses within the specified range can be transferred to the display but do not impact the functionality of the device.

8.5 Climatic ambient conditions

8.5.1 Long-term storage

The following information applies to a device that is stored in its original packaging for longer than two weeks.

The device meets the requirements of IEC 60721-3-1:2018 Class 1K21.

8.5.2 Transport and short-term storage

The following information applies to a device that is transported in the original packaging and weather-proof packaging, and stored from some time.

The device was tested according to IEC 60721-3-2:2018 Class 2K11 with the following amendments and limitations:

Type of condition	Permitted range
Temperature	-20 ... 60 °C
Atmospheric pressure	1140 ... 660 hPa, corresponds to an elevation of -1000 to 3500 m
Relative humidity	10 ... 90 %
Pollutant concentration	In accordance with ANSI/ISA-71.04-2013 severity level G3

Note

If dewing has developed, wait until the HMI device has dried completely before switching it on. Do not expose the HMI device to direct radiation from a heater.

8.5.3 Operating conditions

The following information applies to a device installed according to the specifications in these operating instructions.

The HMI device is designed for weatherproof and stationary operation according to IEC 60721-3-3.

The device was tested according to IEC 60721-3-3:2019 Class 3K22 with the following amendments and limitations:

Type of condition	Mounting position	Permitted range
Temperature, Mounting in landscape format	Vertical	0 ... 50 °C ¹
	Inclined, maximum inclination 35°	0 ... 40 °C
Temperature, Mounting in portrait format	Vertical	0 ... 40 °C
	Inclined, maximum inclination 35°	0 ... 35 °C
Atmospheric pressure ² , operation elevation	1140 ... 795 hPa, corresponds to an elevation of -1000 to 2000 m	
Relative humidity	From 10 ... 90%, no condensation at the rear of the device	
Pollutant concentration	According to ANSI/ISA-71.04-2013 severity level G3	

¹ TP1900 Comfort and TP2200 Comfort: 0 ... 45 °C

² No pressure difference is allowed inside and outside the enclosure / control cabinet

Read the Notes on use (Page 29).

Also observe the climate diagram in the following section and the specifications for the extended inclination and ambient temperature range; see section "Permitted mounting positions (Page 34)".

Note

The system components connected to the HMI device, the power supply for example, must also be suited to the respective operating conditions.

8.5.4 Climate diagram

The diagram below shows the extended range for temperature and humidity during continuous operation based on IEC 60721-3-3:2019 Class 3K22.

The information applies to a device installed in landscape without inclination.

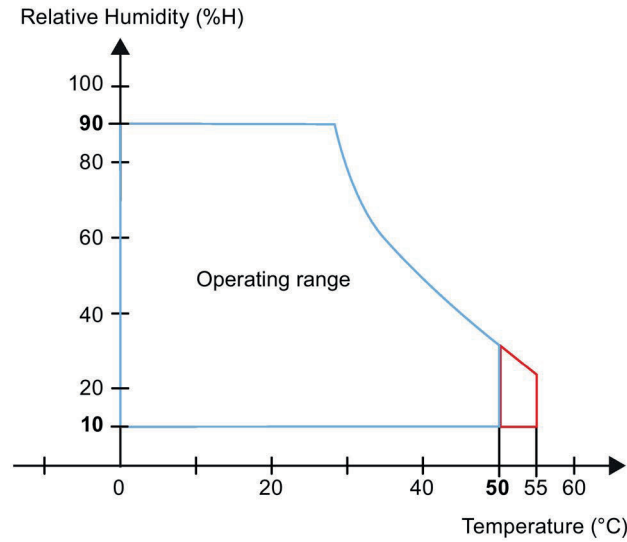

Red: Extended temperature range of 7-15" devices; see section "Permitted mounting positions (Page 34)".

8.6 Information on insulation tests, protection class and degree of protection

Insulation test

The insulation strength is demonstrated in the type test with the following test voltages in accordance with IEC 61010-2-201/IEC 61131-2:

Circuit	Insulation tested with (type test)
Rated voltage U_e 24 V	707 V DC to other circuits / to ground
Ethernet connector	1500 V AC

Degree of pollution and overvoltage category

The device meets the following requirements according to IEC 61010-2-201/IEC 61131-2:

Degree of pollution	2
Overvoltage category	II

Protection class

Protection class III according to IEC 61010-2-201/IEC 61131-2.

Protection against foreign objects and water

The device meets the requirements according to IEC 60529 and UL50.

Device side	Degree of protection
Front	When mounted: <ul style="list-style-type: none">• IP65 according to IEC 60529• Type 4X/Type 12 (indoor use only) according to UL50
Rear panel	IP20 Protection against contact with standard test probes. There is no protection against the ingress of water, dust and noxious gas.

The front protection rating can only be guaranteed if the mounting seal lies flush against the mounting cutout. Read the corresponding information in section "Preparing the mounting cutout (Page 37)".

8.7 Dimension drawings

8.7.1 Dimension drawings of the KP400 Comfort

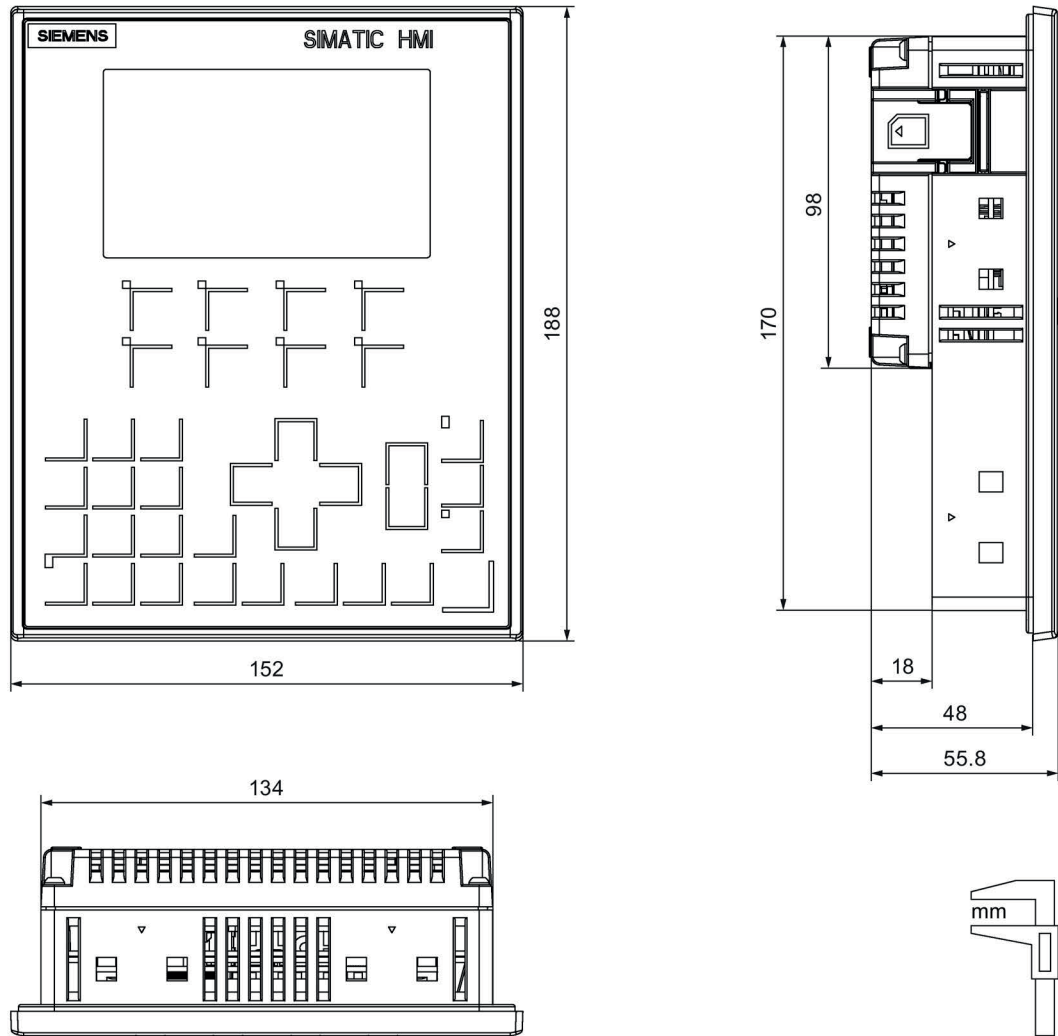

8.7.2 Dimension drawings of the KP700 Comfort

The following figures show the dimension drawings of the Comfort V1/V1.1 devices.

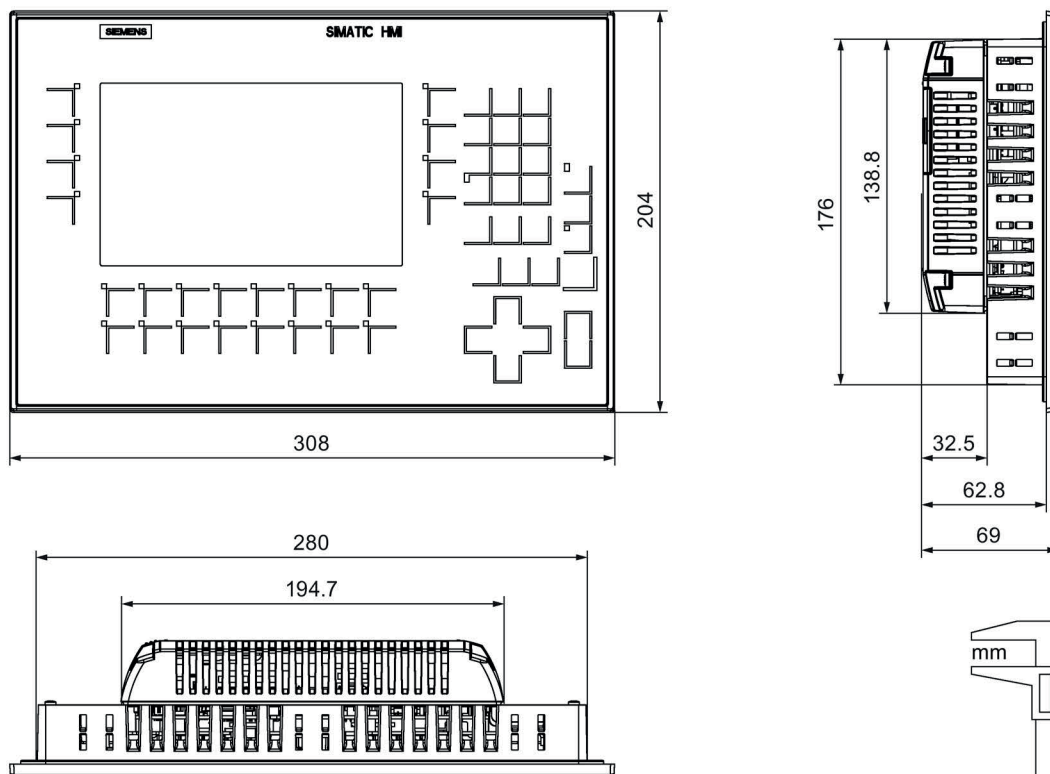

8.7.3 Dimension drawings of the KP900 Comfort

The following figures show the dimension drawings of the Comfort V1/V1.1 devices.

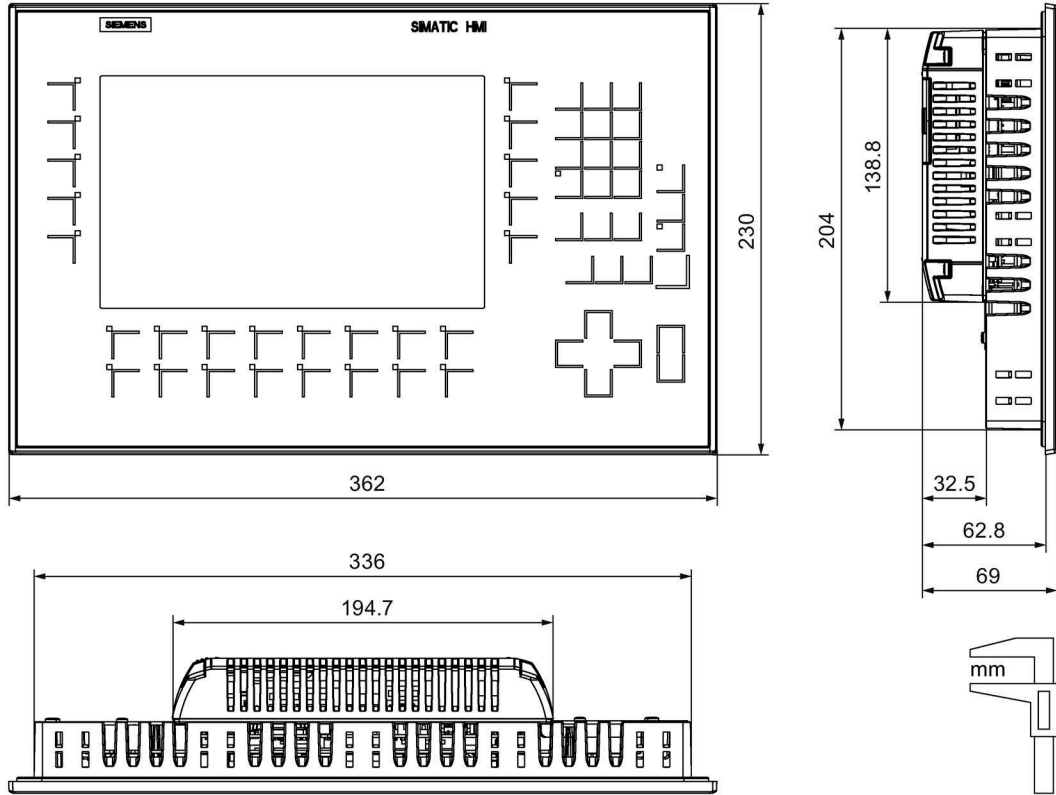

8.7.4 Dimension drawings of the KP1200 Comfort

The following figures show the dimension drawings of the Comfort V1/V1.1 devices.

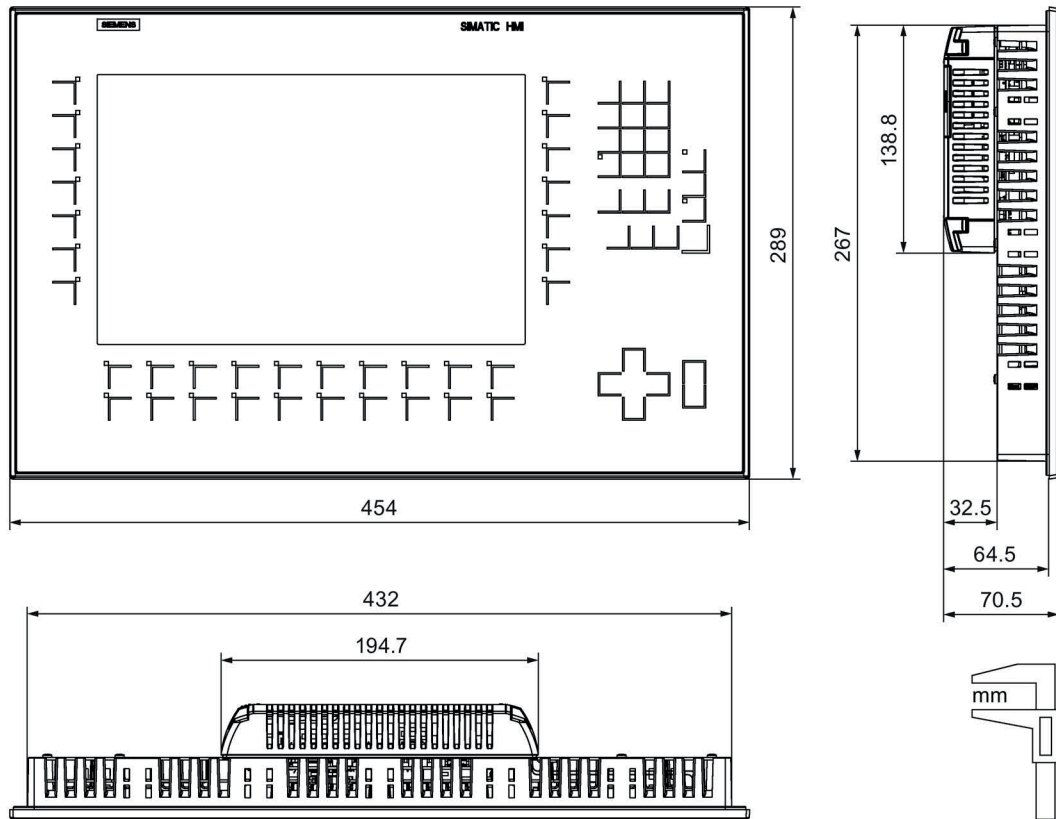

8.7.5 Dimension drawings of the KP1500 Comfort V1

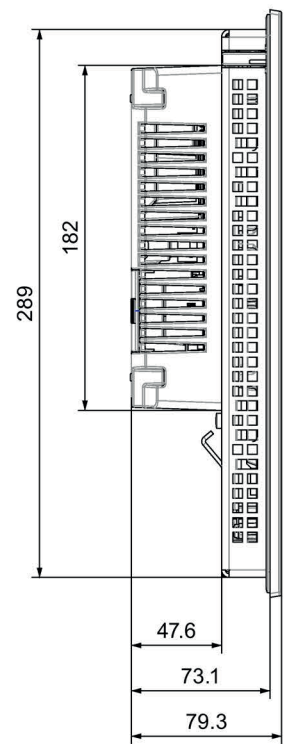
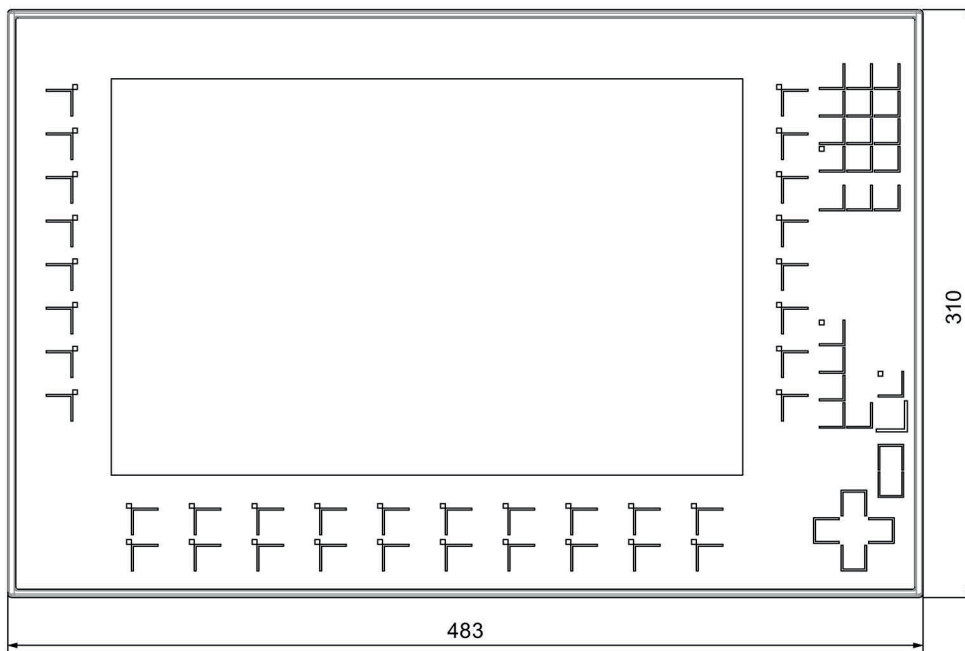
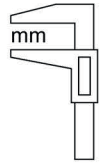
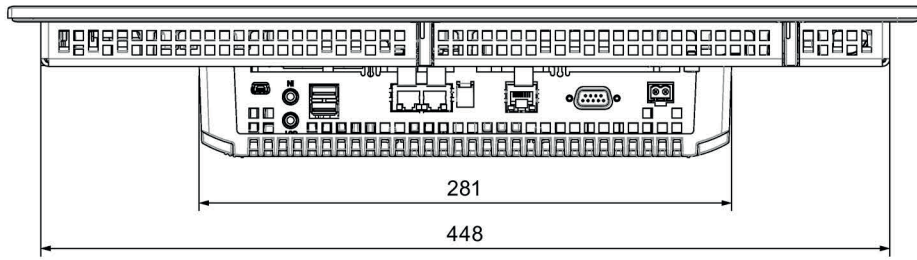

8.7.6 Dimension drawings of the KP1500 Comfort V2

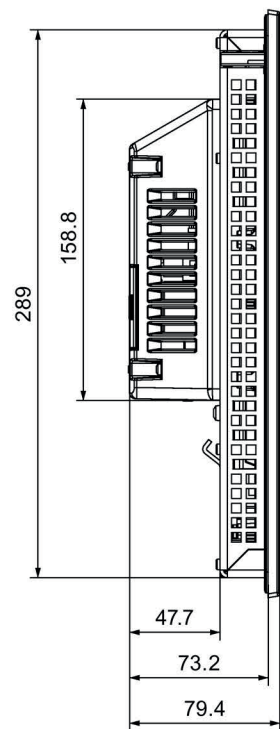
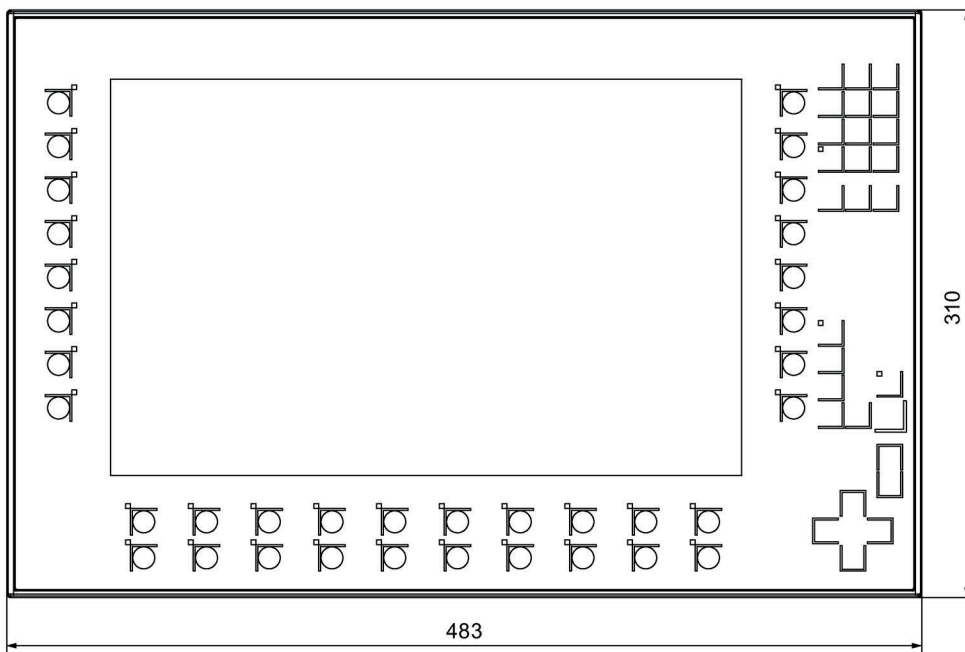
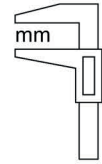
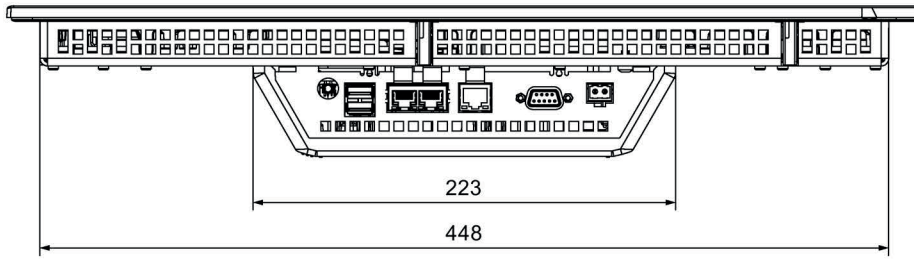

8.7.7 Dimension drawings of the KTP400 Comfort

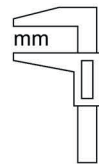
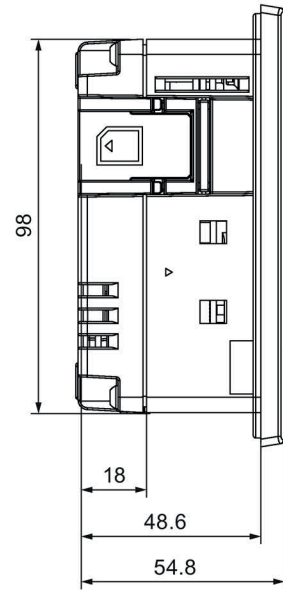
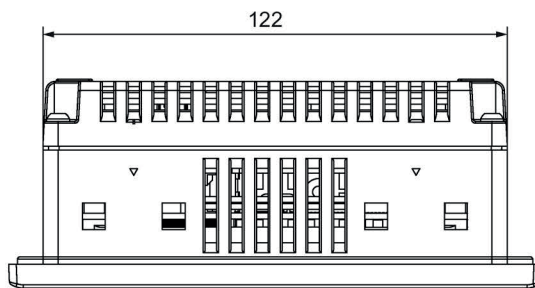
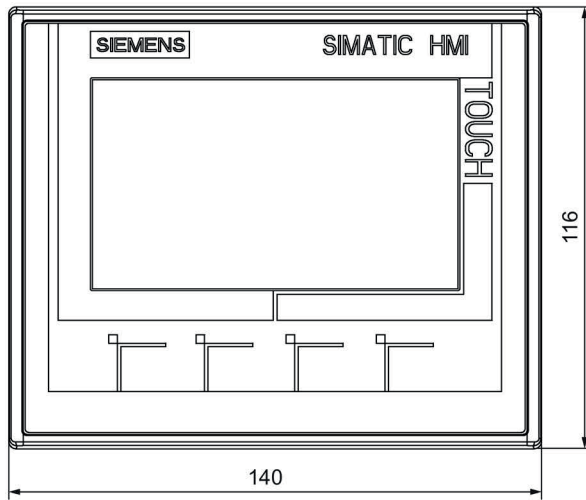

8.7.8 Dimension drawings of the TP700 Comfort

The following figures show the dimension drawings of the Comfort V1/V1.1 devices.

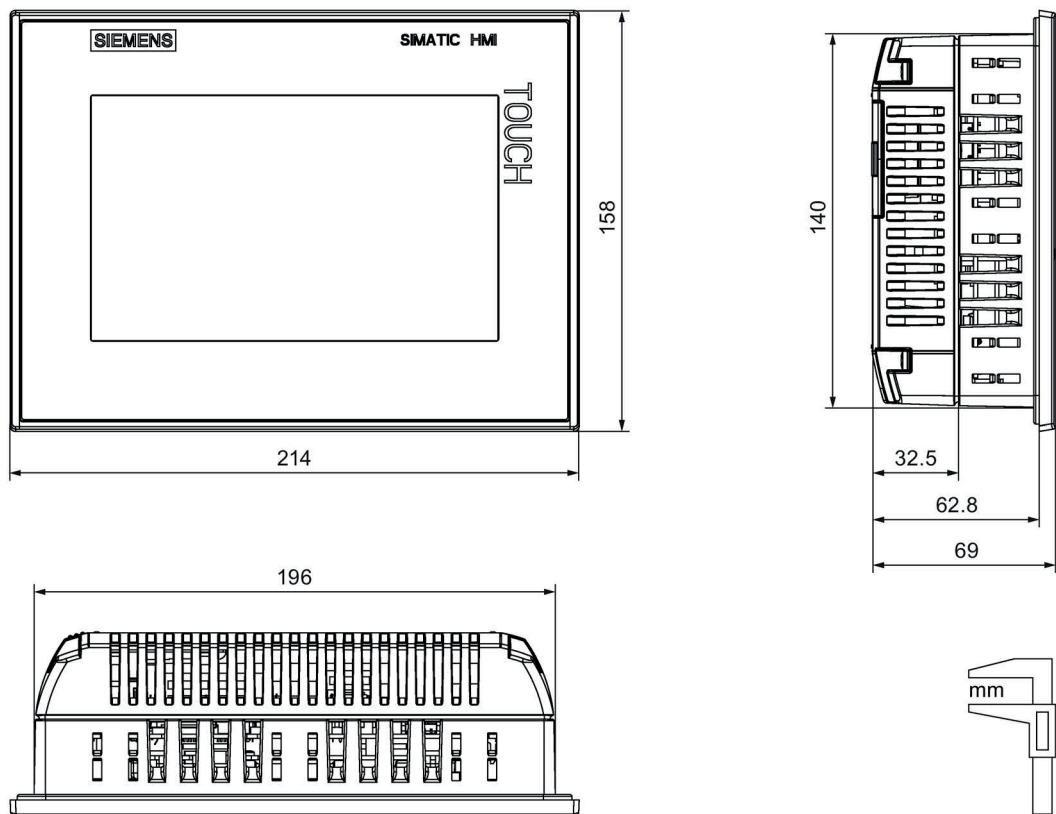

8.7.9 Dimension drawings of the TP900 Comfort

The following figures show the dimension drawings of the Comfort V1/V1.1 devices.

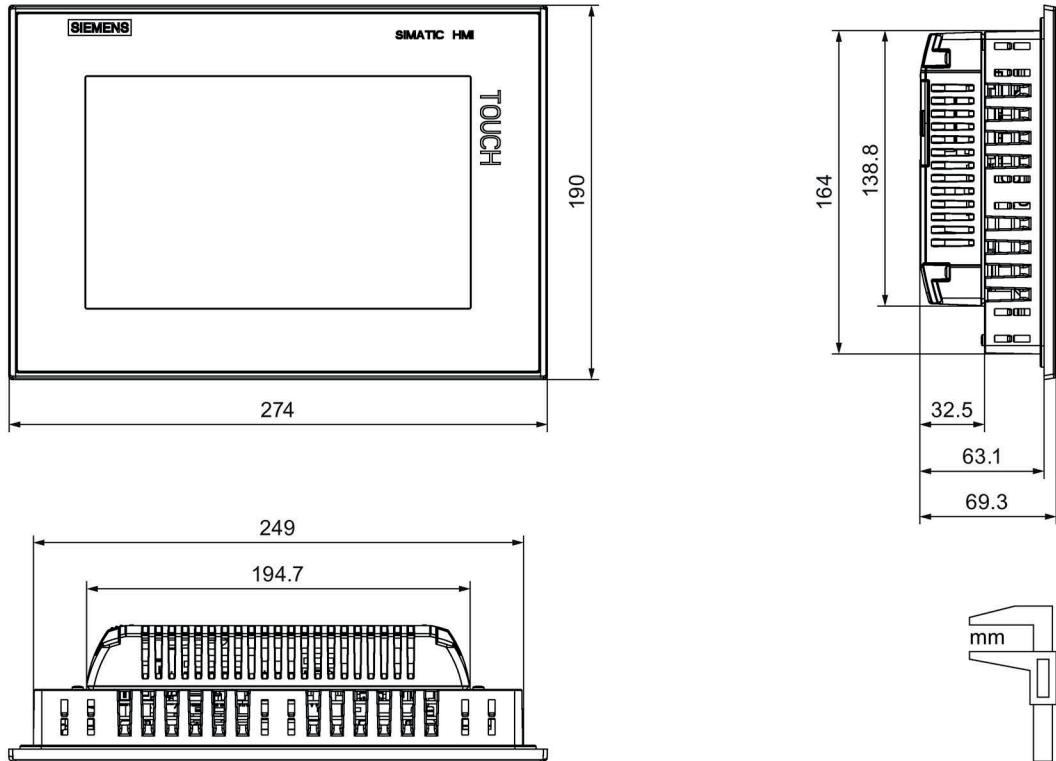

8.7.10 Dimension drawings of the TP1200 Comfort

The following figures show the dimension drawings of the Comfort V1/V1.1 devices.

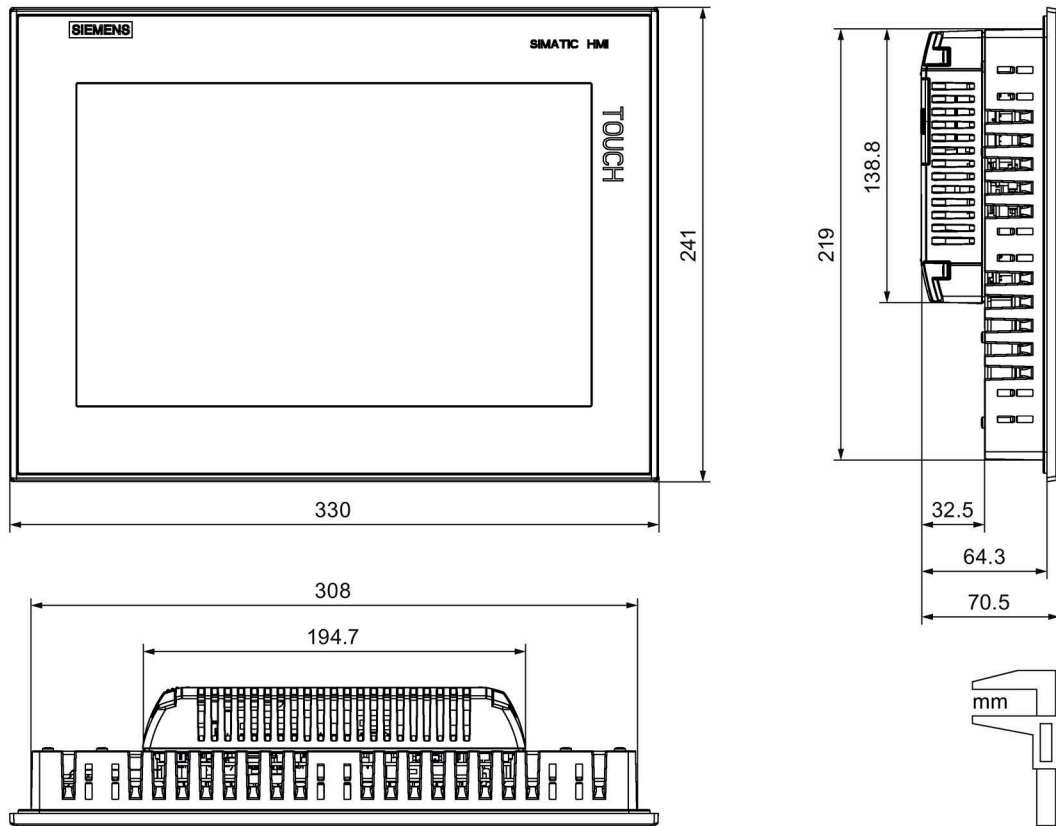

8.7.11 Dimension drawings of the TP1500 Comfort V1

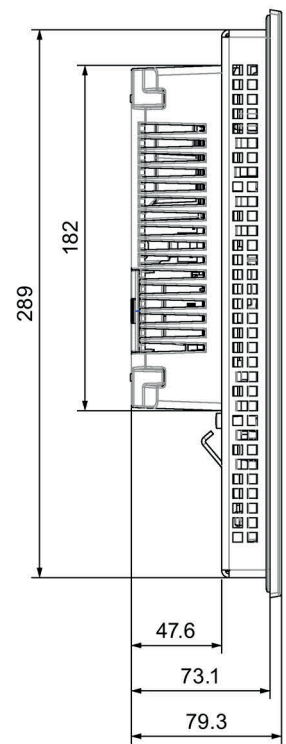
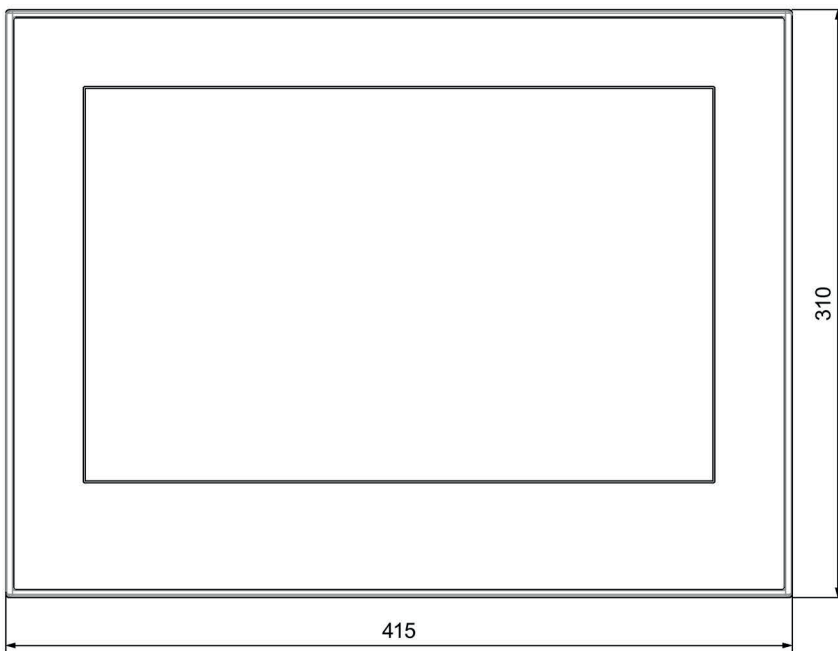
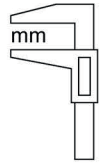
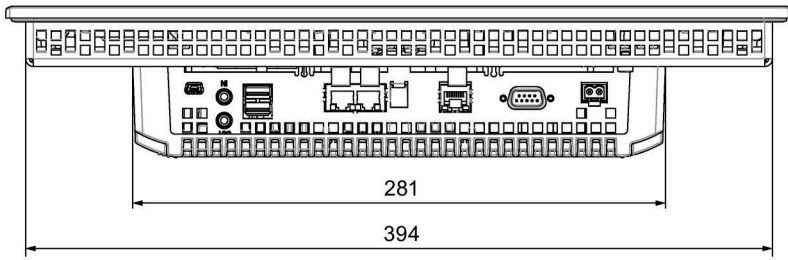

8.7.12 Dimension drawings of the TP1500 Comfort V2

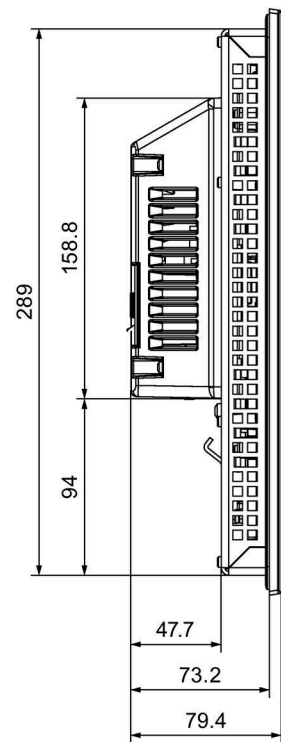
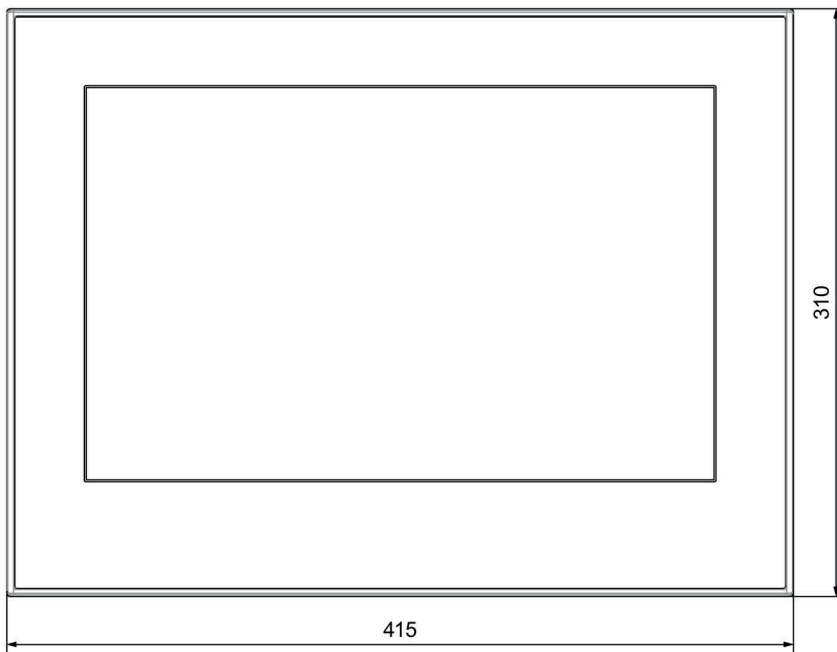
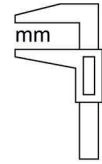
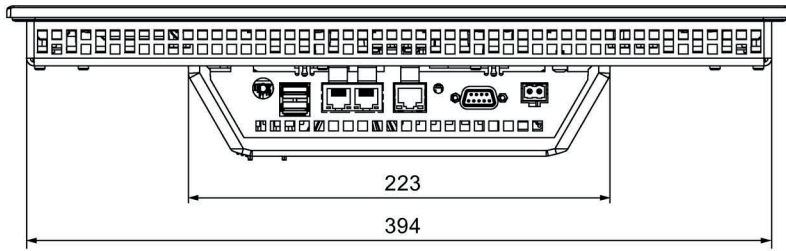

8.7.13 Dimension drawings of the TP1900 Comfort V1

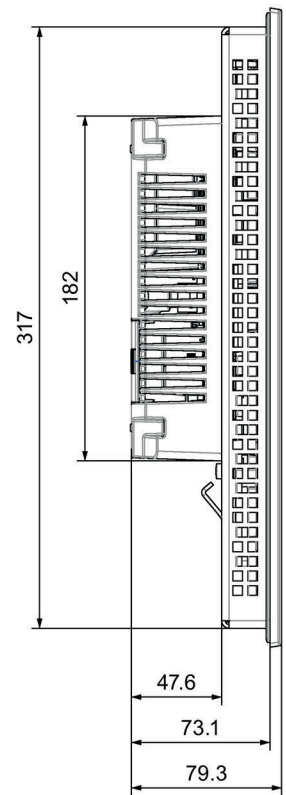
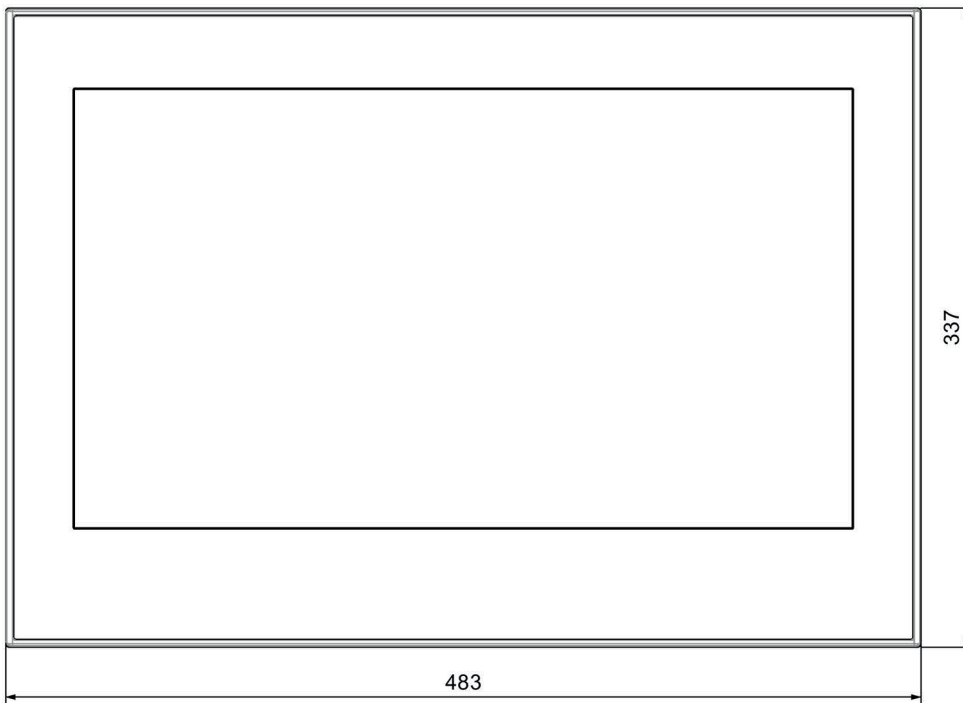
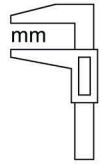
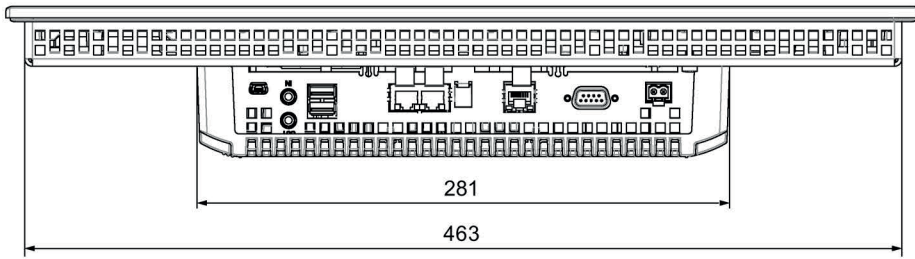

8.7.14 Dimension drawings of the TP1900 Comfort V2

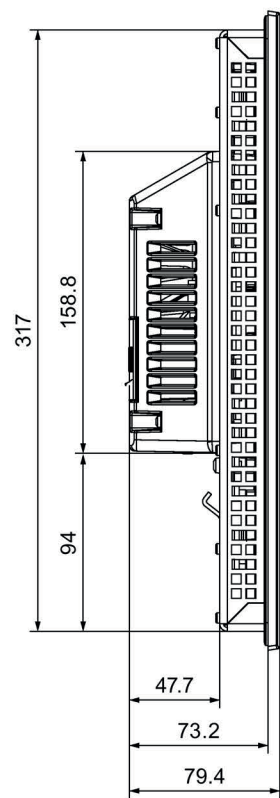
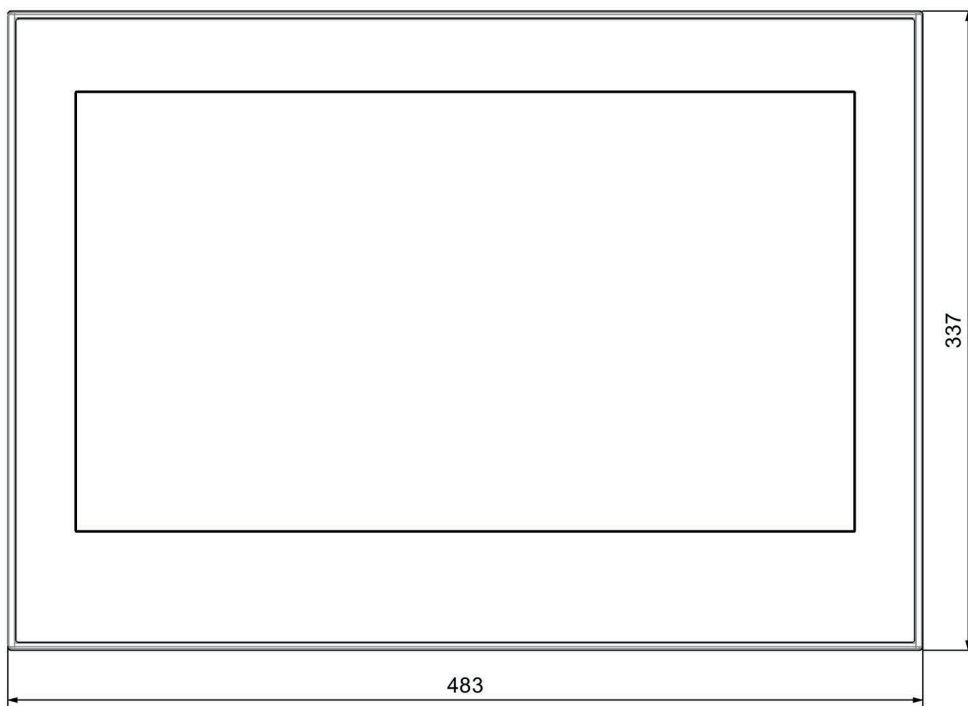
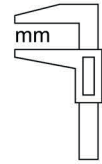
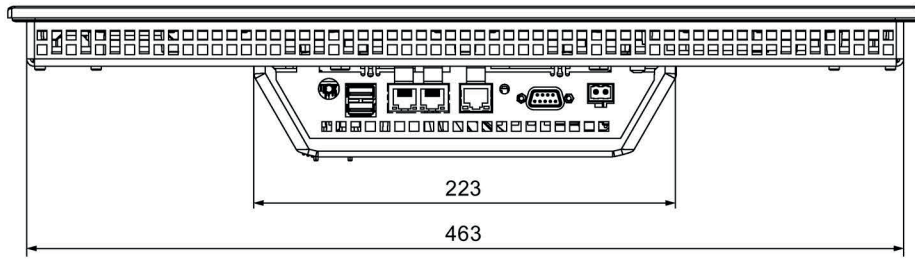

8.7.15 Dimension drawings of the TP2200 Comfort V1

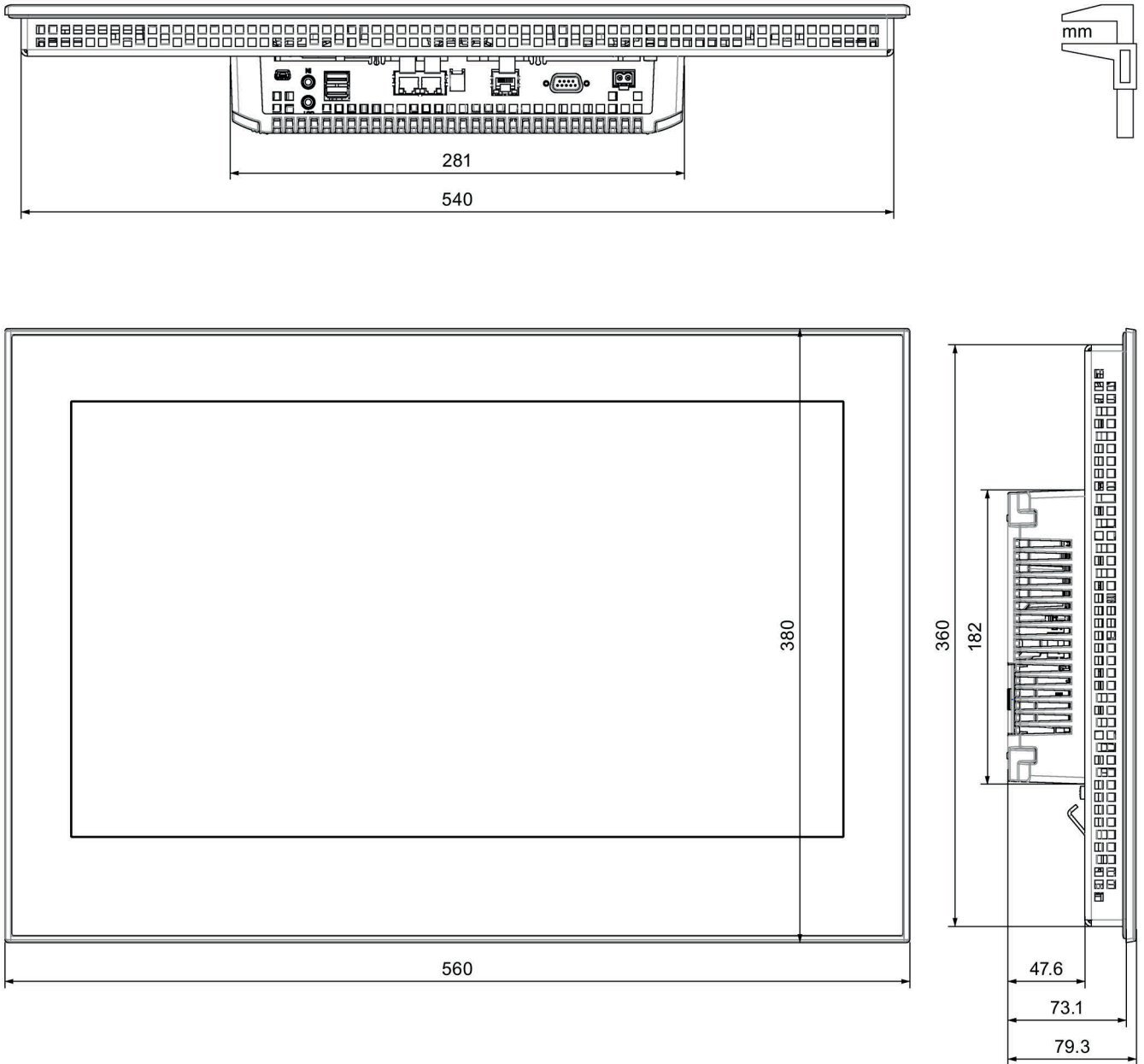

8.7.16 Dimension drawings of the TP2200 Comfort V2

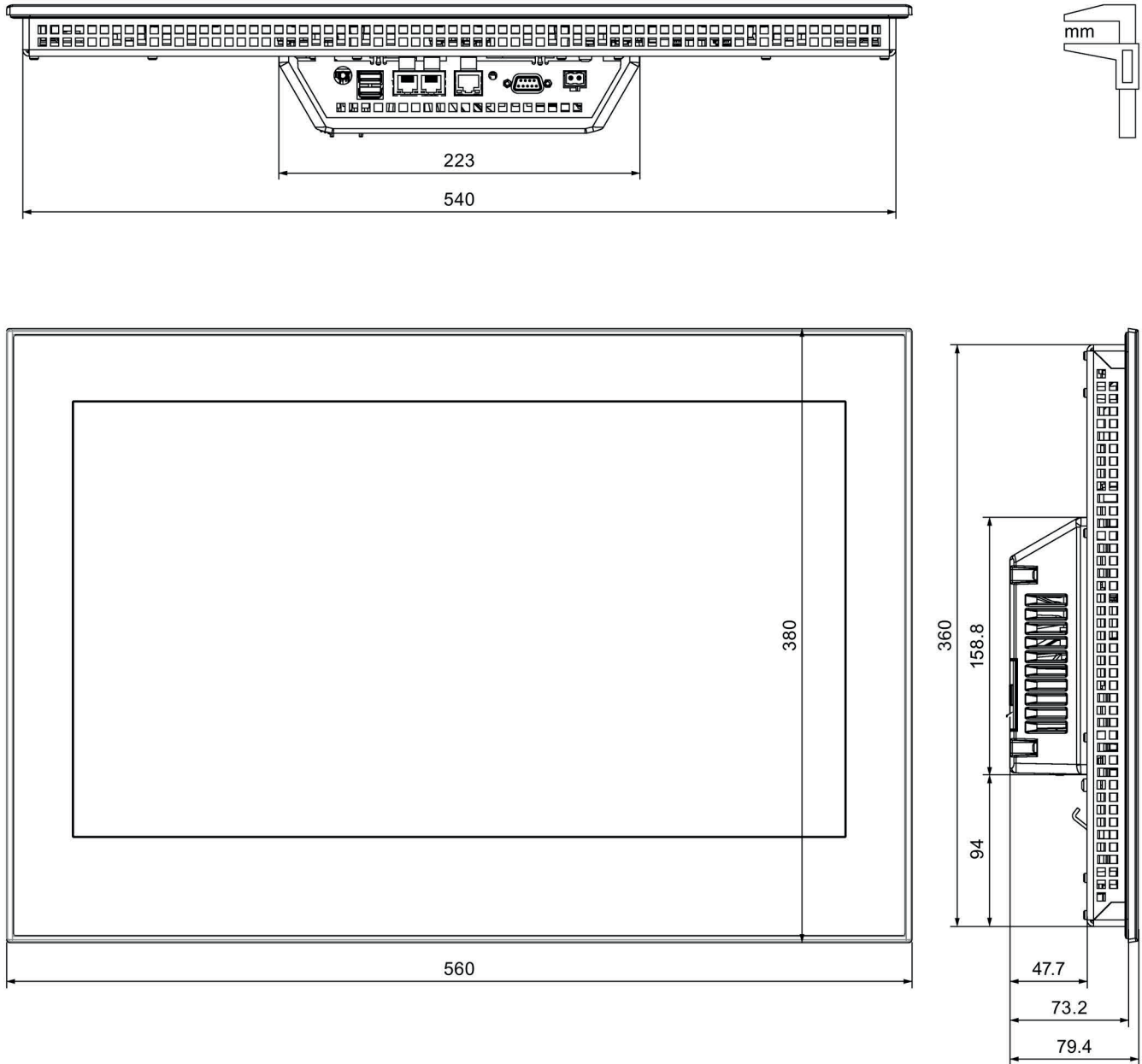

8.7.17 Dimensions for labeling strips

This section contains the labeling strip dimensions for the key variants of the Comfort Panels. All dimensions are specified in mm.

You will find labeling strip templates with a scale of 1:1 as a Word file:

- On the Internet under the following address: Downloads for Comfort Panels (<https://support.industry.siemens.com/cs/ww/en/ps/14742/dl>)
- In the "Support" folder on the WinCC installation DVD

Labeling strips for KP400 Comfort and KTP400 Comfort

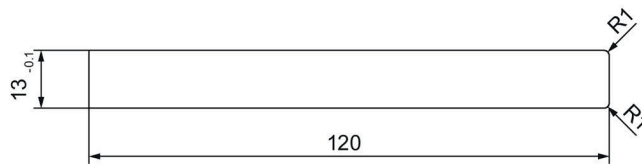

Labeling strips for KP700 Comfort

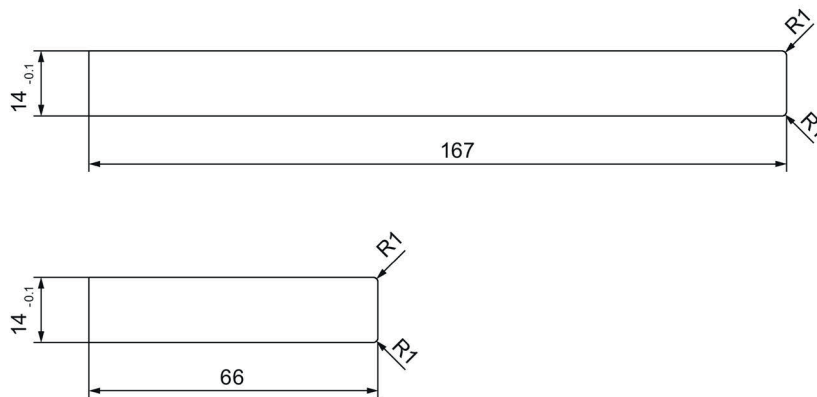

Labeling strips for KP900 Comfort

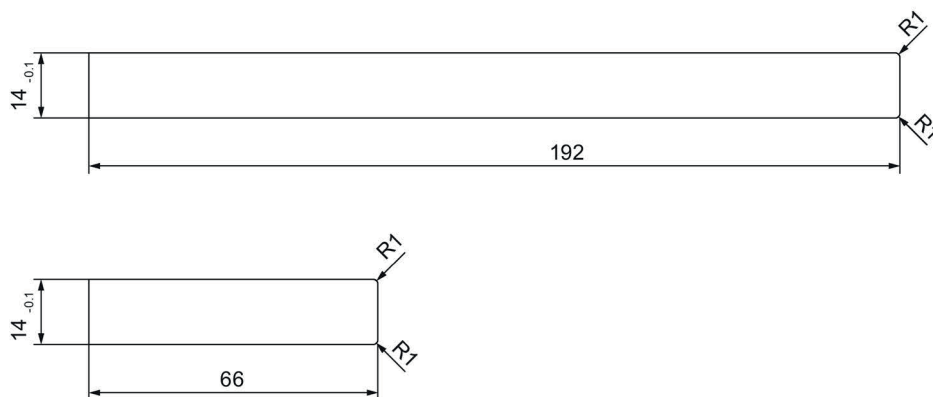

Labeling strips for KP1200 Comfort

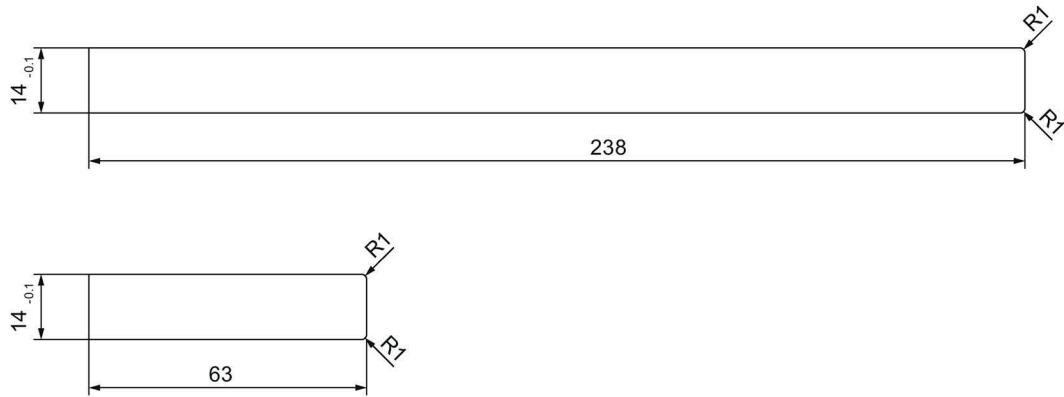

Labeling strips for KP1500 Comfort

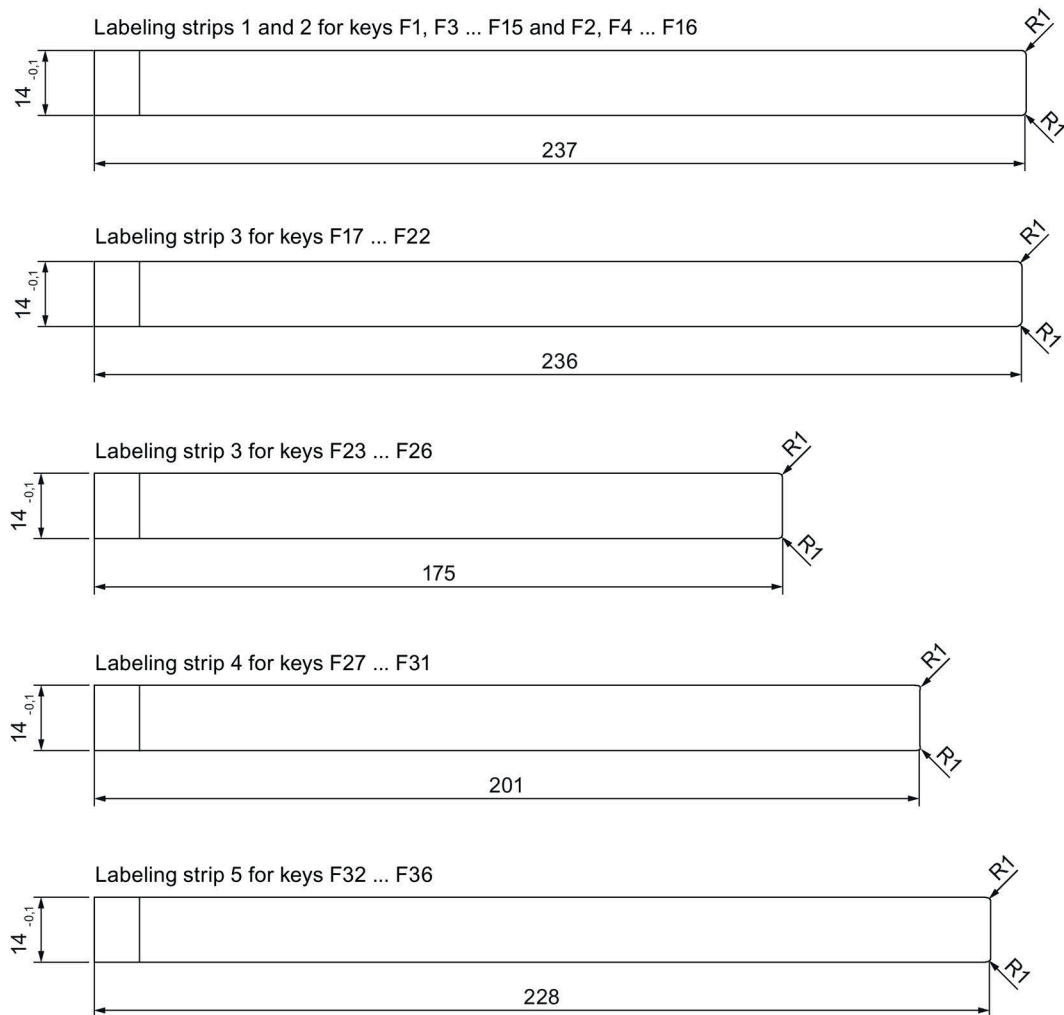

8.8 Technical specifications

8.8.1 KP400 Comfort to KP1200 Comfort, KTP400 Comfort to TP1200 Comfort

Weight

Comfort HMI devices	KP400 Comfort	KTP400 Comfort	KP700 Comfort	TP700 Comfort	KP900 Comfort	TP900 Comfort	KP1200 Comfort	TP1200 Comfort
Weight without packaging	0.8 kg	0.6 kg	2.2 kg	1.4 kg	2.7 kg	1.9 kg	4.4 kg	2.8 kg

Display

Comfort HMI devices	KP400 Comfort	KTP400 Comfort	KP700 Comfort	TP700 Comfort	KP900 Comfort	TP900 Comfort	KP1200 Comfort	TP1200 Comfort
Type	LCD TFT with extended viewing angle							
Active display area	4.3" 95.0 x 53.8 mm		7.0" 152.4 x 91.4 mm		9.0" 195.0 x 117.0 mm		12.1" 261.1 x 163.2 mm	
Resolution	480 x 272 pixels		800 x 480 pixels				1280 x 800 pixels	
Possible colors	Up to 16 million							
Brightness control	Yes, from 0 to 100 ¹ , 0 = backlighting off							
Backlighting	LED							
Half Brightness Life Time (MTBF ²)	80000 h							
Pixel error class in accordance with ISO 9241-307	II			I				

¹ Via WinCC: Complete range, via Control Panel: Minimum to 100

² MTBF: Operating hours after which the maximum brightness is reduced by half compared to the original value. MTBF is increased by using the integrated dimming function, for example time-controlled via screen saver or centrally via PROFInergy.

Input device

Comfort HMI devices	KP400 Comfort	KTP400 Comfort	KP700 Comfort	TP700 Comfort	KP900 Comfort	TP900 Comfort	KP1200 Comfort	TP1200 Comfort
Keyboard (numeric/alpha entry)	Yes	Yes	Yes	No	Yes	No	Yes	No
Touch screen (analog resistive)	No	Yes	No	Yes	No	Yes	No	Yes
Function keys	8	4	24	No	26	No	34	No
Labeling strips	Yes	Yes	Yes	No	Yes	No	Yes	No

Memory

Comfort HMI devices	KP400 Comfort	KTP400 Comfort	KP700 Comfort	TP700 Comfort	KP900 Comfort	TP900 Comfort	KP1200 Comfort	TP1200 Comfort
Usable memory for application data	4 MB		12 MB					
Usable memory for recipe data ¹	512 KB		2 MB					
Additional memory for options	4 MB		12 MB					
Data memory card ²	1 x MMC/SD combination slot							
System memory card ²	1 x SD slot							

¹ Can be extended via memory card

² Memory cards are available as SIMATIC HMI accessories

Interfaces

Comfort HMI devices	KP400 Comfort	KTP400 Comfort	KP700 Comfort	TP700 Comfort	KP900 Comfort	TP900 Comfort	KP1200 Comfort	TP1200 Comfort
1 x RS 422/485 (PROFIBUS)	Max. 12 Mbps, applies to DP operations							
Ethernet (PROFINET)	1 x RJ45 10/100 Mbps		2 x RJ45 10/100 Mbps ¹					
Audio	-		Line Out					
USB 2.0	1 x Host ² 1 x Device ³		2 x Host ² 1 x Device ³					

¹ With integrated switch (one IP address only)

² USB type A, maximum load 500 mA, equivalent to USB standard 2.0

³ USB type Mini-B (5-pin), equivalent to USB standard 2.0

Power supply

Comfort HMI devices	KP400 Comfort	KTP400 Comfort	KP700 Comfort	TP700 Comfort	KP900 Comfort	TP900 Comfort	KP1200 Comfort	TP1200 Comfort
Rated voltage	24 V DC							
Permitted voltage range	+19.2 V ... +28.8 V							
Mains and voltage buffering time	20 ms, corresponds to PS2 according to IEC 61131-2							
Rated current	0.13 A		0.5 A		0.75 A		0.85 A	
Rated current (min. ... max.), load-dependent	0.13 ... 0.55 A		0.5 ... 0.85 A		0.75 ... 1.05 A		0.85 A ... 1.20 A	
Inrush current I^2t	0.5 A ² s							
Power consumption ¹	3.1 W		12 W		18 W		20 W	
Maximum permitted transients	35 V (500 ms)							
Minimum time between two transients	50 s							
Internal protection	Yes							

¹ The power loss generally corresponds to the specified value for power consumption.

Miscellaneous

Comfort HMI devices	KP400 Comfort	KTP400 Comfort	KP700 Comfort	TP700 Comfort	KP900 Comfort	TP900 Comfort	KP1200 Comfort	TP1200 Comfort
Buffered real-time clock ¹	Yes							
Audio reproduction	Onboard beeper		Integrated or external via Line OUT					

¹ Battery backup typically 6 weeks

8.8.2 KP1500 Comfort, TP1500 Comfort to TP2200 Comfort

Weight

Comfort V1 devices	KP1500 Comfort V1	TP1500 Comfort V1	TP1900 Comfort V1	TP2200 Comfort V1
Weight without packaging	5.4 kg	5.2 kg	6.5 kg	7.1 kg

Comfort V2 devices	KP1500 Comfort V2	TP1500 Comfort V2	TP1900 Comfort V2	TP2200 Comfort V2
Weight without packaging	4.7 kg	4.4 kg	5.6 kg	6.7 kg

Display

Comfort HMI devices	KP1500 Comfort	TP1500 Comfort	TP1900 Comfort	TP2200 Comfort
Type	LCD TFT with extended viewing angle		LCD TFT	LCD TFT with extended viewing angle
Active display area	15.4" 331.2 x 207.0 mm		18.5" 409.8 x 230.4 mm	21.5" 475.2 x 267.3 mm
Resolution	1280 x 800 pixels		1366 x 768 pixels	1920 x 1080 pixels
Possible colors	Up to 16 million			
Brightness control	Yes, from 0 to 100 ¹ , 0 = backlighting off			
Backlighting	LED		LED	LED
Half Brightness Life Time (MTBF ²)	80000 h		50000 h	30000 h
Pixel error class in accordance with ISO 9241-307	I			

¹ Via WinCC: Complete range, via Control Panel: Minimum to 100

² MTBF: Operating hours after which the maximum brightness is reduced by half compared to the original value. MTBF is increased by using the integrated dimming function, for example time-controlled via screen saver or centrally via PROflenergy.

Input device

Comfort HMI devices	KP1500 Comfort	TP1500 Comfort	TP1900 Comfort	TP2200 Comfort
Keyboard (numeric/alpha entry)	Yes		No	
Touch screen (analog resistive)	No		Yes	
Function keys	36		No	
Labeling strips	Yes		No	

Memory

Comfort HMI devices	KP1500 Comfort	TP1500 Comfort	TP1900 Comfort	TP2200 Comfort
Usable memory for application data	24 MB			
Usable memory for recipe data ¹	4 MB			
Additional memory for options	24 MB			
Data memory card ²	1 x MMC/SD combination slot			
System memory card ²	1 x SD slot			

¹ Can be extended via memory card

² Memory cards are available as SIMATIC HMI accessories

Interfaces

Comfort HMI devices	KP1500 Comfort	TP1500 Comfort	TP1900 Comfort	TP2200 Comfort
1 x RS 422/485 (PROFIBUS)	Max. 12 Mbps, applies to DP operations			
Ethernet (PROFINET)	2 x RJ45 10/100 Mbps ¹			
Ethernet (PROFINET basic functionality)	1 x RJ45 10/100/1000 Mbps			
Audio	Line Out			
USB 2.0	2 x Host ² 1 x Device ³			

¹ With integrated switch (one IP address only)

² USB type A, maximum load 500 mA, equivalent to USB standard 2.0

³ USB type Mini-B (5-pin); not with Comfort V2 devices; equivalent to USB standard 2.0

Power supply

Comfort V1 devices	KP1500 Comfort V1	TP1500 Comfort V1	TP1900 Comfort V1	TP2200 Comfort V1
Rated voltage	24 V DC			
Permitted voltage range	+19.2 V ... +28.8 V			
Mains and voltage buffering time	20 ms, corresponds to PS2 according to IEC 61131-2			
Rated current	1.5 A		1.3 A	2.2 A
Rated current (min. ... max.), load-dependent	1.5 ... 3.5 A		1.3 ... 3.7 A	
Inrush current I ² t	0.5 A ² s			
Power consumption ¹	36 W		32 W	53 W
Maximum permitted transients	35 V (500 ms)			
Minimum time between two transients	50 s			
Internal protection	Yes			

¹ The power loss generally corresponds to the specified value for power consumption.

Comfort V2 devices	KP1500 Comfort V2	TP1500 Comfort V2	TP1900 Comfort V2	TP2200 Comfort V2
Rated voltage	24 V DC			
Permitted voltage range	+19.2 V to +28.8 V			
Rated current	1.7 A		1.7 A	1.7 A
Rated current, load-dependent	1.45 ... 2.1 A		1.4 ... 2.1 A	
Inrush current I ² t	0.5 A ² s			
Power consumption ¹	41 W		41 W	41 W
Maximum permitted transients	35 V (500 ms)			
Minimum time between two transients	50 s			
Internal protection	Yes			

¹ The power loss generally corresponds to the specified value for power consumption.

Miscellaneous

Comfort HMI devices	KP1500 Comfort	TP1500 Comfort	TP1900 Comfort	TP2200 Comfort
Buffered real-time clock ¹	Yes			
Audio reproduction	Integrated or external via Line OUT			

¹ Battery backup typically 6 weeks

8.9 Bit assignment of the direct keys

The following figures show the assignment of the keys and LEDs to the bytes in the controller process image.

Additional information may be available in your system documentation.

8.9.1 KTP400 Comfort

HMI device	Inputs	Outputs
Touch operation	4 bytes	-

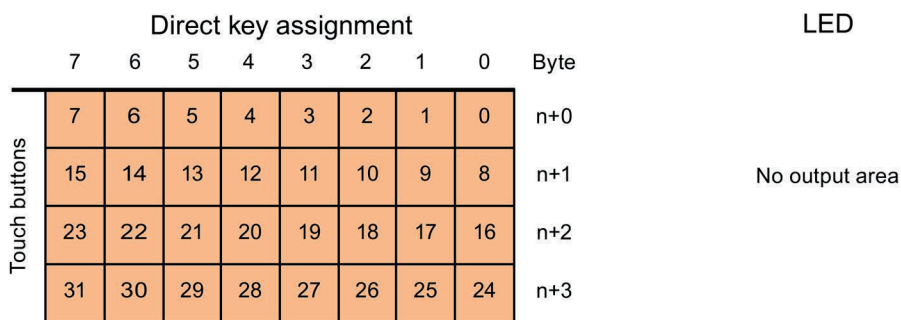

HMI device	Inputs	Outputs
Key operation	1 byte	1 byte

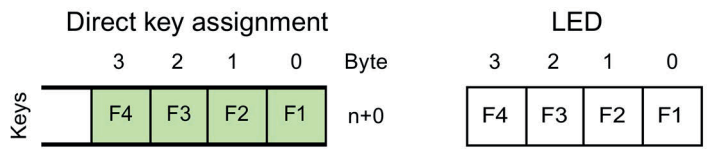

8.9.2 KP400 Comfort

Inputs	Outputs
1 byte	1 byte

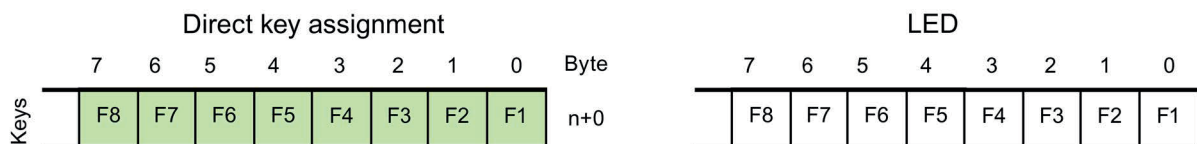

8.9.3 KP700 Comfort

Inputs	Outputs
3 bytes	3 bytes

Direct key assignment

	7	6	5	4	3	2	1	0	Byte
Keys	F8	F7	F6	F5	F4	F3	F2	F1	n+0
	F16	F15	F14	F13	F12	F11	F10	F9	n+1
	F24	F23	F22	F21	F20	F19	F18	F17	n+2

LED

	7	6	5	4	3	2	1	0
F8	F7	F6	F5	F4	F3	F2	F1	
F16	F15	F14	F13	F12	F11	F10	F9	
F24	F23	F22	F21	F20	F19	F18	F17	

8.9.4 TP700 Comfort

Inputs	Outputs
4 bytes	--

Direct key assignment

	7	6	5	4	3	2	1	0	Byte
Touch buttons	7	6	5	4	3	2	1	0	n+0
	15	14	13	12	11	10	9	8	n+1
	23	22	21	20	19	18	17	16	n+2
	31	30	29	28	27	26	25	24	n+3

LED

No output area

8.9.5 KP900 Comfort

Inputs	Outputs
4 bytes	4 bytes

Direct key assignment								LED																	
								Byte																	
								7	6	5	4	3	2	1	0										
Keys	7	6	5	4	3	2	1	0	n+0	F8	F7	F6	F5	F4	F3	F2	F1	F8	F7	F6	F5	F4	F3	F2	F1
	F16	F15	F14	F13	F12	F11	F10	F9	n+1	F16	F15	F14	F13	F12	F11	F10	F9	F16	F15	F14	F13	F12	F11	F10	F9
	F24	F23	F22	F21	F20	F19	F18	F17	n+2	F24	F23	F22	F21	F20	F19	F18	F17	F24	F23	F22	F21	F20	F19	F18	F17
								F26	F25	n+3								F18	F17						

8.9.6 TP900 Comfort

Inputs	Outputs
5 bytes	--

Direct key assignment								LED																	
								Byte																	
								7	6	5	4	3	2	1	0										
Touch buttons	7	6	5	4	3	2	1	0	n+0	7	6	5	4	3	2	1	0	No output area							
	15	14	13	12	11	10	9	8	n+1	15	14	13	12	11	10	9	8								
	23	22	21	20	19	18	17	16	n+2	23	22	21	20	19	18	17	16								
	31	30	29	28	27	26	25	24	n+3	31	30	29	28	27	26	25	24								
	39	38	37	36	35	34	33	32	n+4	39	38	37	36	35	34	33	32								

8.9.7 KP1200 Comfort

Inputs		Outputs	
5 bytes		5 bytes	

Direct key assignment								LED											
		7	6	5	4	3	2	1	0			7	6	5	4	3	2	1	0
Keys		F8	F7	F6	F5	F4	F3	F2	F1	n+0		F8	F7	F6	F5	F4	F3	F2	F1
		F16	F15	F14	F13	F12	F11	F10	F9	n+1		F16	F15	F14	F13	F12	F11	F10	F9
		F24	F23	F22	F21	F20	F19	F18	F17	n+2		F24	F23	F22	F21	F20	F19	F18	F17
		F32	F31	F30	F29	F28	F27	F26	F25	n+3		F32	F31	F30	F29	F28	F27	F26	F25
								F34	F33	n+4								F34	F33

8.9.8 TP1200 Comfort

Inputs		Outputs	
5 bytes		--	

Direct key assignment								LED											
		7	6	5	4	3	2	1	0			7	6	5	4	3	2	1	0
Touch buttons		7	6	5	4	3	2	1	0	n+0	No output area								
		15	14	13	12	11	10	9	8	n+1									
		23	22	21	20	19	18	17	16	n+2									
		31	30	29	28	27	26	25	24	n+3									
		39	38	37	36	35	34	33	32	n+4									

8.9.9 KP1500 Comfort

Inputs	Outputs
5 bytes	5 bytes

Direct key assignment

	7	6	5	4	3	2	1	0	Byte
Keys	F8	F7	F6	F5	F4	F3	F2	F1	n+0
	F16	F15	F14	F13	F12	F11	F10	F9	n+1
	F24	F23	F22	F21	F20	F19	F18	F17	n+2
	F32	F31	F30	F29	F28	F27	F26	F25	n+3
				F36	F35	F34	F33		n+4

LED

	7	6	5	4	3	2	1	0
F8	F7	F6	F5	F4	F3	F2	F1	
F16	F15	F14	F13	F12	F11	F10	F9	
F24	F23	F22	F21	F20	F19	F18	F17	
F32	F31	F30	F29	F28	F27	F26	F25	
				F36	F35	F34	F33	

8.9.10 TP1500, TP1900 and TP2200 Comfort

Inputs	Outputs
5 bytes	--

Direct key assignment

	7	6	5	4	3	2	1	0	Byte
Touch buttons	7	6	5	4	3	2	1	0	n+0
	15	14	13	12	11	10	9	8	n+1
	23	22	21	20	19	18	17	16	n+2
	31	30	29	28	27	26	25	24	n+3
	39	38	37	36	35	34	33	32	n+4

LED

No output area

8.10 Description of the interfaces

8.10.1 DC24V X80

Power supply 24 V DC 2-pin

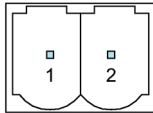

Pin	Meaning
1	+24 V DC
2	Ground

8.10.2 PROFIBUS DP X2

Serial interface, 9-pin sub-D socket, female

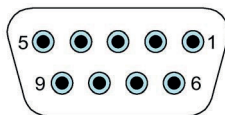

Pin	Assignment for the RS422	Assignment for the RS485
1	NC	NC
2	GND 24 V	GND 24 V
3	TxD+	Data signal B (+)
4	RxD+	RTS
5	GND 5 V, floating	GND 5 V, floating
6	+5 VDC, floating	+5 VDC, floating
7	+24 VDC, out (max. 100 mA)	+24 VDC, out (max. 100 mA)
8	TxD-	Data signal A (-)
9	RxD-	NC

8.10.3 PROFINET (LAN) X1

PROFINET (LAN) 10/100 Mbps, RJ45 socket

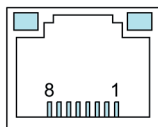

Pin	Name	Meaning
1	Tx+	Data output +
2	Tx-	Data output -
3	Rx+	Data input +
4	NC	Not assigned
5	NC	Not assigned
6	Rx-	Data input -
7	NC	Not assigned
8	NC	Not assigned

8.10.4 PROFINET (LAN) X3

PROFINET (LAN) 10/100/1000 Mbps, RJ45 socket

Models of 15" and more have this interface.

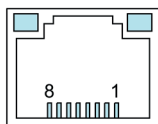

Pin	Name	Meaning
1	D1+	Bi-directional data 1+
2	D1-	Bi-directional data 1-
3	D2+	Bi-directional data 2+
4	D3+	Bi-directional data 3+
5	D3-	Bi-directional data 3-
6	D2-	Bi-directional data 2-
7	D4+	Bi-directional data 4+
8	D4-	Bi-directional data 4-

8.10.5 USB X61/X62

USB Type A

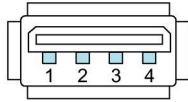

Pin	Name	Meaning
1	VBUS	+5 V, out, max. 500 mA
2	D-	Data channel, bidirectional
3	D+	Data channel, bidirectional
4	GND	Ground

8.10.6 USB X60 of the Comfort V1/V1.1 devices

USB Type Mini-B

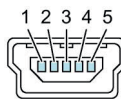

Pin	Name	Meaning
1	VBUS	Not assigned
2	D-	Data channel, bidirectional
3	D+	Data channel, bidirectional
4	ID	Not assigned
5	GND	Ground

8.10.7 Audio X90

Audio, associated connector:

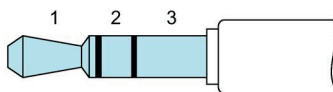

Pin	Name	Meaning
1	L	Left audio channel
2	R	Right audio channel
3	GND	Ground

8.11 Communication with controllers

Number of connections

Connection	KP400 Comfort KTP400 Comfort	KP700 Comfort to KP1500 Comfort TP700 Comfort to TP2200 Comfort
Number using a bus connection	4	8
Number of connections based on "SIMATIC HMI HTTP Protocol"	4	8

Note

Communication faults with PROFINET IO

If you enable PROFINET services in the Control Panel of the HMI device, communication problems can occur if you use controllers from other manufacturers.

Controllers that are not compatible with PROFINET services are noted in the following table in the footnote. Do not enable PROFINET services for these controllers.

Controllers

The table below shows the controllers and the communication drivers which can be used with the HMI devices.

Controller	HMI devices
SIMATIC S7-1500	Yes
SIMATIC S7-1200	Yes
SIMATIC S7-300/400	Yes
SIMATIC S7-200	Yes
SIMATIC HTTP protocol	Yes
LOGO!	Yes
Allen-Bradley EtherNet/IP	Yes
Allen-Bradley DF1	Yes ^{1,2}
Mitsubishi MC TCP/IP	Yes
Mitsubishi FX	Yes ²
Modicon Modbus TCP/IP	Yes
Modicon Modbus RTU	Yes ²
Omron Hostlink	Yes ²

¹ Direct communication with PLC 5 with the KF2 module, otherwise only released via the optional RS422-RS232 converter, article number 6AV6 671-8XE00-0AX0.

² PROFINET IO must be disabled.

Using secure HMI communication

As of TIA Portal V17, HMI devices support secure HMI communication in combination with a controller that also supports secure HMI communication.

For detailed information on secure HMI communication, see:

- In the TIA information system under "Edit devices and networks > Configure devices and networks > Configure networks > Secure communication"
- In the S7-1500, ET200 communication manual (<https://support.industry.siemens.com/cs/ww/en/view/59192925>)

The following sections describe the main steps for using secure HMI communication on the HMI device.

Configuring secure HMI communication

1. Configure the HMI device with an alarm control.

Note

Without the alarm control you cannot detect errors when establishing a connection.

2. Configure the CPU with the required security settings. Select a PLC communication certificate to secure the HMI connection or have a PLC communication certificate generated by the TIA Portal.
3. Configure the HMI connection between CPU and HMI device.
4. Download the project into the CPU and the HMI device. During the project transfer, the PLC communication certificate and, if necessary, also a required CA certificate (certificate authority) is transferred to the CPU and to the HMI device.

Note

Updating and loading the CPU configuration requires a new download to the HMI device

If the configuration of the CPU is changed and downloaded to the controller, the PLC communication certificate of the controller is updated. In this case, the PLC communication certificate of the HMI device must also be updated by means of a new project download.

Trusting the PLC communication certificate

During the connection setup the CPU transfers the PLC communication certificate to the HMI device. Distinguish between the following cases:

- If the PLC communication certificate already has the status "trusted" on the HMI device, secure HMI communication is automatically established between CPU and HMI device.
- If the PLC communication certificate is not yet available in the "trusted" status on the HMI device, the alarm control of the HMI device displays an alarm that the CPU is not trusted along with an error code.

In this case, you must label the PLC communication certificate on the HMI device as "trusted".

To label the PLC communication certificate as "trusted", follow these steps.

1. Open the file manager via the Windows CE desktop icon "My Device".
2. Navigate to the "\\flash\simatic\SystemRoot\OMS\Untrusted" directory. There you will find the PLC communication certificate of the CPU.
3. Copy the PLC communication certificate of the CPU to the directory "\\flash\simatic\SystemRoot\OMS\Trusted".
4. Restart the HMI Runtime software.

Secure HMI communication can be established when the PLC communication certificate has the status "trusted" on the HMI device.

Note

Changing a connection

In the Control Panel, you can disconnect the active controller connection and establish a new connection to a controller with a different IP address. The newly connected controller must belong to the same device class (S7-1200, S7-1500, etc.) and support the same security level of communication.

It is not possible to switch back and forth between control connections with and without secure HMI communication.

See also

Configuring a communication connection (Page 156)

8.12 Scope of functions with WinCC

The tables below show the objects which can be integrated in a project for an HMI device.

Note

The specified values are maximum values of the individual objects. Simultaneous use of multiple objects with their maximum value can lead to problems in the active project.

Alarms

Object	Specification	HMI devices		
		KP400 Comfort KTP400 Comfort	KP700 Comfort to KP1200 Comfort, TP700 Comfort to TP1200 Comfort	KP1500 Comfort, TP1500 Comfort to TP2200 Comfort
Alarms	Number of discrete alarms	2000	4000	6000
	Number of analog alarms	50	200	
	Alarm length	80 characters		
	Number of tags / process values in an alarm	Max. 8		
	Number of alarm classes	32		
	Display	Alarm window, alarm view		
	Acknowledge error alarm individually	Yes		
	Edit alarm	Yes		
	Alarm indicator	Yes		
ALARM_S	Display S7 alarms	Yes		
Message buffer with retentivity ¹	Alarm buffer capacity	256	1024	
	Simultaneously queued alarm events	64	500	
	View alarm	Yes		
	Delete alarm buffer	Yes		
	Print alarms line by line	Yes		

¹ As of WinCC V15.1 retentivity can be deactivated.

Note

Read the notes on using the internal memory

If too many alarms are written to the alarm buffer in short time intervals, the life of the internal memory and thus the service life of the HMI device will be reduced.

When configuring alarms, read the notes on the internal memory in the section "Memory concept (Page 63)".

Tags, values and lists

Object	Specification	HMI devices		
		KP400 Comfort KTP400 Comfort	KP700 Comfort to KP1200 Comfort, TP700 Comfort to TP1200 Comfort	KP1500 Comfort, TP1500 Comfort to TP2200 Comfort
Tags	Quantity	1024	2048	4096
Limit value monitoring	Input/output	Yes		
Linear scaling	Input/output	Yes		
Text lists	Quantity	300	500 ¹	
Graphics lists	Quantity	100	500 ¹	

¹ The maximum total of text and graphics lists is 500.

Screens

Object	Specification	HMI devices		
		KP400 Comfort KTP400 Comfort	KP700 Comfort to KP1200 Comfort, TP700 Comfort to TP1200 Comfort	KP1500 Comfort, TP1500 Comfort to TP2200 Comfort
Screens	Quantity	500		750
	Objects per screen	50	400	600
	Tags per screen	50	400	400
	Complex objects per screen (for example, bars)	5	20	40
	Template	Yes		

Recipes

Object	Specification	HMI devices		
		KP400 Comfort KTP400 Comfort	KP700 Comfort to KP1200 Comfort, TP700 Comfort to TP1200 Comfort	KP1500 Comfort, TP1500 Comfort to TP2200 Comfort
Recipes	Quantity	100	300	500
	Data records per recipe	200	500	1000
	Entries per data record	200	1000	2000
	Recipe memory	512 KB	2 MB	4 MB
	Storage location ¹	<ul style="list-style-type: none"> Memory card (MMC/SD) USB storage medium Network drive 		

¹ The number of recipe data records may be restricted by the capacity of the storage medium.

Logs

Note

The HMI devices are suitable for the logging of relatively small volumes of data.

Manage the data in several adjacent logs in a segmented circular log. The use of a large circular log has a negative effect on performance.

Object	Specification	HMI devices		
		KP400 Comfort KTP400 Comfort	KP700 Comfort to KP1200 Comfort, TP700 Comfort to TP1200 Comfort	KP1500 Comfort, TP1500 Comfort to TP2200 Comfort
Logs	Number of logs	10	50	
	Number of partial logs in a segmented circular log	400		
	Entries per log ¹	10000	20000	50000
	Filing format	CSV with ANSI character set, RDB, TXT		
	Storage location	<ul style="list-style-type: none"> • Memory card • USB storage medium • Network drive 		

¹ The number of entries in the log may be restricted by the capacity of the storage medium.

Read the notes on using logs in the section "Memory concept (Page 63)".

Safety

Object	Specification	HMI devices		
		KP400 Comfort KTP400 Comfort	KP700 Comfort to KP1200 Comfort, TP700 Comfort to TP1200 Comfort	KP1500 Comfort, TP1500 Comfort to TP2200 Comfort
User view	Number of user groups	50		
	Number of users	50		
	Number of authorizations/ user permissions	32		

Infotexts

Object	Specification	HMI devices		
		KP400 Comfort KTP400 Comfort	KP700 Comfort to KP1200 Comfort, TP700 Comfort to TP1200 Comfort	KP1500 Comfort, TP1500 Comfort to TP2200 Comfort
Infotexts	Length (no. of characters)	500 (depending on font)		
	For alarms	Yes		
	For screens	Yes		
	For screen objects (e.g. I/O field, switch, button, invisible button)	Yes		

Additional functions

Object	Specification	HMI devices		
		KP400 Comfort KTP400 Comfort	KP700 Comfort to KP1200 Comfort, TP700 Comfort to TP1200 Comfort	KP1500 Comfort, TP1500 Comfort to TP2200 Comfort
Screen settings	Touch screen calibration ¹	Yes		
	Brightness setting	Yes		
Language change	Number of languages per project	32		
VBScript	User-specific extension of the functionality	Yes		
	Number of scripts	50	100	200
Graphic objects	Vector and pixel graphics	Yes		
Trends	Quantity	50	300	400
Task planner	Number of tasks	10	48	
Text objects	Quantity	2500	40000	
Direct keys	PROFIBUS DP direct keys	Yes		
	PROFINET IO direct keys	Yes		

¹ For HMI devices with touch screen only

Technical Support

A.1 Service and support

You can find additional information and support for the products described on the Internet at the following addresses:

- Technical support (<https://support.industry.siemens.com>)
- Support request form (<https://www.siemens.com/supportrequest>)
- After Sales Information System SIMATIC IPC/PG (<https://www.siemens.com/asis>)
- SIMATIC Documentation Collection (<https://www.siemens.com/simatic-tech-doku-portal>)
- Your local representative (https://www.automation.siemens.com/aspa_app)
- Training center (<https://siemens.com/sitrain>)
- Industry Mall (<https://mall.industry.siemens.com>)

When contacting your local representative or Technical Support, please have the following information at hand:

- MLFB of the device
- BIOS version for industrial PC or image version of the device
- Other installed hardware
- Other installed software

Current documentation

Always use the current documentation available for your product. You can find the latest edition of this manual and other important documents by entering the article number of your device on the Internet (<https://support.industry.siemens.com>). If necessary, filter the comments for the entry type "Manual".

Tools & downloads

Please check regularly if updates and hotfixes are available for download to your device. The download area is available on the Internet at the following link:

After Sales Information System SIMATIC IPC/PG (<https://www.siemens.com/asis>)

A.2 Troubleshooting

This section contains information on localizing and rectifying possible faults.

Error message	Possible cause	Remedy
"System card is missing or defective"	No system memory card inserted.	Insert a system memory card. Use only the SIMATIC HMI Memory Card \geq 2 GB.
	System memory card is defective.	Replace the defective system memory card with a new SIMATIC HMI Memory Card. To continue working without the service concept, acknowledge the error message each time the HMI device is started. You can use the "Do not show this message again" option to suppress the error message. To reactivate the service concept, you have to insert an intact system memory card.
"System card error"	The system memory card from a device of a different type has been inserted.	Replace the system memory card with the system memory card of a device of the same type.
		You can use the system memory card with the device without using the data of the system memory card. In this case, all the data in the "System Card\SIMATIC.HMIActive" folder will be deleted. To back up this data, activate the "Start backup" check box and specify the storage medium. Then click on the "Continue" button.

A.3 Application examples and FAQs

Application examples

You can find application examples on the Internet at the following address:

Application examples Comfort Panels

(<https://support.industry.siemens.com/cs/ww/en/ps/14742/ae>).

FAQs

Frequently asked questions on Comfort Panels are available on the Internet at the following address:

FAQs Comfort Panels (<https://support.industry.siemens.com/cs/ww/en/ps/14742/faq>).

A.4 System alarms

System alarms on the HMI device provide information about internal states of the HMI device and the controller.

Note

System alarms are only indicated if an alarm window was configured. System alarms are output in the language currently set on your HMI device.

System alarm parameters

System alarms may contain encrypted parameters which are relevant to troubleshooting because they provide a reference to the source code of the runtime software. These parameters are output after the text "Error code:".

Read the notes on configuring system alarms and using the alarm buffer in the section "Memory concept (Page 63)".

Description of the system alarms

A listing of all system alarms for your HMI device is provided in the online help of your configuration software.

A.5 Information about the manufacturer

Siemens AG is the manufacturer of the HMI devices described in this document.











The manufacturer address is:

Siemens AG
Digital Industries
Postfach 48 48
90026 NÜRNBERG
GERMANY

Markings and symbols





B.1 Safety-relevant symbols

The following table describes symbols that can be added to your SIMATIC device, to its packaging or to an enclosed document in addition to the symbols described in the manuals.

Symbol	Meaning	Reference
	General danger sign Caution / Attention You must following the operating instructions. The operating instructions contain information on the type of the potential hazard and enable you to identify risks and implement countermeasures.	ISO 7000 No. 0434B, DIN ISO 7000 No. 0434B
 ONLY EX MODULES	Attention, only relevant for modules with Ex approval	
	Follow the instructions	ISO 7010 M002
	May be installed by qualified electricians only	IEC 60417 No. 6182
 F<2N DISPLAY F<4N HOUSING	Mechanical load for HMI devices	
 CABLE SPEC.	Connection cables must be designed for the ambient temperature	
 EMC	EMC-compliant installation	
 U = 0V	No mounting or pulling & plugging under voltage	
 230V MODULES	Dangerous electrical voltage for 230V modules	ANSI Z535.2
 24V MODULES	Protection class III, supply only with protective low voltage (SELV/PELV)	IEC 60417-1-5180 "Class III equipment"

Markings and symbols

B.1 Safety-relevant symbols

Symbol	Meaning	Reference
 INDOOR USE ONLY INDUSTRIAL USE ONLY	Only for industrial applications and indoor areas (control cabinet)	
	Device is to be integrated or installed in a control cabinet	
 ZONE 2 USE CABINET IP54	Integrate or install devices approved for Ex Zone 2 in a control cabinet with at least IP54	
 ZONE 22 USE CABINET IP6x	Integrate or install devices approved for Ex Zone 22 in a control cabinet with at least IP6x	

Abbreviations

C

ANSI	American National Standards Institution
CPU	Central Processing Unit
CSV	Comma Separated Values
CTS	Clear To Send
DC	Direct Current
DCD	Data Carrier Detect
DHCP	Dynamic Host Configuration Protocol
DIL	Dual-in-Line (electronic chip housing design)
DNS	Domain Name System
DP	Distributed I/O
DSN	Data Source Name
DSR	Data Set Ready
DTR	Data Terminal Ready
IO	Input and Output
ESD	Components and modules endangered by electrostatic discharge
EMC	Electromagnetic Compatibility
EN	European standard
ES	Engineering System
ESD	Components and modules endangered by electrostatic discharge
GND	Ground
HF	High Frequency
HMI	Human Machine Interface
IEC	International Electronic Commission
IF	Interface
IP	Internet Protocol
LED	Light Emitting Diode
MAC	Media Access Control
MOS	Metal Oxide Semiconductor
MPI	Multipoint Interface (SIMATIC S7)
MS	Microsoft
MTBF	Mean Time Between Failures
n. c.	Not connected
OP	Operator Panel
PC	Personal Computer
PG	Programming device
PPI	Point-to-Point Interface (SIMATIC S7)
RAM	Random Access Memory
PELV	Protective Extra Low Voltage
RJ45	Registered Jack Type 45
RTS	Request to send

RxD	Receive Data
SD Memory Card	Abbreviation of Secure Digital Memory Card
SELV	Safety Extra Low Voltage
SP	Service Pack
PLC	Programmable Logic Controller
SUB-D	Subminiature D (plug)
TAB	Tabulator
TCP/IP	Transmission Control Protocol/Internet Protocol
TFT	Thin Film Transistor
TxD	Transmit Data
UL	Underwriter's Laboratory
USB	Universal Serial Bus
UPS	Uninterruptible power supply
WINS	Windows Internet Naming Service

Glossary

"Transfer" mode

The "Transfer" operating mode is an operating mode of the HMI device in which an executable project is transferred from the configuration PC to an HMI device.

Acknowledge

Acknowledgment of an alarm confirms that it has been noted.

Alarm logging

Output of user-specific alarms to a printer, in parallel to their output to the HMI device screen.

Alarm, "Incoming" event

Moment at which an alarm is triggered by the controller or HMI device.

Alarm, "Outgoing" event

Moment at which the initiation of an alarm is reset by the controller.

Alarm, acknowledgment

Acknowledgment of an alarm confirms that it has been noted.

Alarm, user-specific

A user-specific alarm report specific operating states of a system interconnected to the HMI device via the controller.

Automation system

An automation system is a controller of the SIMATIC S7 series, for example SIMATIC S7-1500.

Boot loader

The boot loader is used to start the operating system and is started automatically after power on of the HMI device. The Start Center opens after the operating system has loaded.

Commercial goods

In addition to their own accessories, Siemens AG is also offering high-quality accessories from well-known manufacturers as commercial goods. Commercial goods are qualified in a brief power-up test but do not go through the system test of the Siemens AG. The technical properties of commercial goods can deviate from the properties guaranteed by comparable products of the Siemens AG. Commercial goods are identified as such in the online catalog of the Siemens AG. Technical specifications, drivers, certificates, test verification documents, etc. are supplied by the respective manufacturer to Siemens AG and are also available for download in the online catalog or technical support of the Siemens AG.

configuration PC

A configuration PC is a programming device or PC on which system projects are created using engineering software.

Configuration software

Configuration software is used to create projects used for the purpose of process visualization. WinCC represents such configuration software, for example.

Controller

Controller is a general term for devices and systems with which the HMI device communicates, for example SIMATIC S7.

Degree of protection

The degree of protection specifies a standard of electronic equipment for a variety of ambient conditions – and the protection of humans against potential danger when using this equipment.

The degree of protection classified by IP differs from the protection class. But both involve protection against touching dangerous electric voltage. The degree of protection also classifies the protection of equipment against dirt and moisture.

Display duration

Defines whether a system alarm is displayed on the HMI device and the duration of the display.

EMC

Electromagnetic compatibility (EMC) refers to a usually desirable state, in which technical equipment does not disturb one another with unwanted electrical or electromagnetic effects. Electromagnetic compatibility deals with technical and regulatory questions of undesired, mutual influence in electrical engineering.

Event

Functions are triggered by defined incoming events. Events can be configured. Events which can be assigned to a button include "Press" and "Release", for example.

Field

Area reserved in configured screens for the input and output of values.

Flash memory

Flash memory is a non-volatile memory with EEPROM chips that is implemented either as mobile storage medium, or as permanently installed memory module on the motherboard.

Function key

Function keys on the HMI device can be assigned user-specific functions. The functions assigned to these keys are defined during configuration. The assignment of the function keys may be specific to an active screen or independent of it.

Half Brightness Life Time

Time period after which brightness is reduced to 50% of the original value. The specified value depends on the operating temperature.

Hardcopy

Output of the screen content to a printer.

HMI device

An HMI device is a device used for the operation and monitoring of machines and systems. The machine or system states are visualized on the HMI device by means of graphic objects or signal lamps. The operator controls of the HMI device allow the operator to interact with the processes of the machine or system.

HMI device image

The HMI device image is a file that can be transferred from the configuration PC to the HMI device. The HMI device image contains the operating system for the HMI device and the elements of the runtime software required to run a project.

I/O field

An I/O field enables the input or output of values on the HMI device which are transferred to the controller.

Infotext

An infotext is a configured information on objects within a project. Infotext for an alarm, for example, may contain information on the cause of the fault and troubleshooting routines.

Job mail

A job mail triggers a function for the controller on the HMI device.

Object

An object is a project element such as a screen or an alarm. Objects are used to view or enter texts and values on the HMI device.

Operating element

An operating element is a component of a project used to enter values and trigger functions. A button, for example, is an operating element.

Process visualization

Process visualization is the representation of technical processes by means of text and graphic elements. Configured system screens allow operator intervention in active system processes using the input and output data.

Project

A project is the result of a configuration using a configuration software. The project normally contains several screens with embedded system-specific objects, basic settings and alarms. A project configured with WinCC is saved in a file with extension "*.ap1x", where "x" stands for the version key. Example: "MyProject.ap14" for a WinCC V14 project.

Project file, executable

An executable project file is the file generated for a particular HMI device within the scope of configuration. The executable project file is transferred to the associated HMI device where it is used to operate and monitor systems. The executable project file is always stored on the HMI device under "\Flash\Simatic".

The file extension of an executable project file is "*.fwf".

Protection class

The protection class is used in electrical engineering to classify and identify electrical equipment in relation to existing safety measures designed to prevent electric shock. There are three protection classes for electrical equipment.

Recipe

A recipe is a combination of tags that form a fixed data structure. The configured data structure can be assigned data in the configuration software or on the HMI device and is then referred to as a record. The use of recipes ensures that all data assigned to a data record is transferred synchronously to the controller.

Runtime software

The runtime software is a process visualization software used to test a project on a configuration PC.

Screen

A screen is a form of visualization for all logically related process data in a system. The representation of the process data can be visually supported by graphic objects.

Screen object

A screen object refers to objects such as rectangles, I/O fields or alarm views which are configured for visualization or operation of the system.

System

General term referring to machines, processing centers, systems and processes which are operated and monitored on an HMI device.

System alarm

A system alarm is assigned to the "System" alarm class. A system alarm refers to internal states on the HMI device and the controller.

Tab order

The tab order defined in the course of project engineering determines the sequence for activating objects by pressing the <TAB> key.

Tag

A tag is a defined memory location to which values can be written and from which values can be read. This can be done from the controller or the HMI device. We distinguish between external tags (process tags) and internal tags, depending on whether or not the tag is interconnected with the controller.

Transfer

Transfer of a runtime project from the configuration PC to the HMI device.

WinCC

WinCC (TIA Portal) is the engineering software for configuring SIMATIC Panels, SIMATIC Industrial PCs and standard PCs with WinCC Runtime Advanced visualization software or the WinCC Runtime Professional SCADA system.