

ACS800

www.nicsanat.com
021-87700210



Firmware Manual
ACS800 Standard Control Program 7.x

www.nicsanat.com

021-87700210



ABB



ACS800 Standard Control Program 7.x

Firmware Manual

3AFE64527592 REV L

EN

EFFECTIVE: 2011-08-25

Table of contents

Table of contents

Introduction to the manual

Chapter overview	13
Compatibility	13
Safety instructions	13
Reader	13
Contents	13
Product and service inquiries	14
Product training	14
Providing feedback on ABB Drives manuals	14

Start-up and control through the I/O

Chapter overview	15
How to start-up the drive	15
How to perform the guided start-up (covers all essential settings)	15
How to perform the limited start-up (covers only the basic settings)	17
How to control the drive through the I/O interface	21
How to perform the ID Run	22
ID Run Procedure	22

Control panel

Chapter overview	25
Overview of the panel	25
Panel operation mode keys and displays	26
Status row	26
Drive control with the panel	27
How to start, stop and change direction	27
How to set speed reference	28
Actual signal display mode	29
How to select actual signals to the display	29
How to display the full name of the actual signals	30
How to view and reset the fault history	30
How to display and reset an active fault	31
About the fault history	31
Parameter mode	32
How to select a parameter and change the value	32
How to adjust a source selection (pointer) parameter	33
Function mode	34
How to enter an assistant, browse and exit	35
How to upload data from a drive to the panel	36

How to download data from the panel to a drive	37
How to set the contrast of the display	38
Drive selection mode	39
How to select a drive and change its panel link ID number	39
Reading and entering packed boolean values on the display	40

Program features

Chapter overview	41
Start-up Assistant	41
Introduction	41
The default order of the tasks	41
List of tasks and the relevant drive parameters	42
Contents of the assistant displays	43
Local control vs. external control	43
Local control	44
External control	44
Settings	44
Diagnostics	44
Block diagram: start, stop, direction source for EXT1	45
Block diagram: reference source for EXT1	45
Reference types and processing	46
Settings	46
Diagnostics	46
Reference trimming	47
Settings	47
Example	48
Programmable analogue inputs	49
Update cycles in the Standard Control Program	49
Settings	49
Diagnostics	49
Programmable analogue outputs	50
Update cycles in the Standard Control Program	50
Settings	50
Diagnostics	50
Programmable digital inputs	51
Update cycles in the Standard Control Program	51
Settings	51
Diagnostics	51
Programmable relay outputs	52
Update cycles in the Standard Control Program	52
Settings	52
Diagnostics	52
Actual signals	53
Settings	53
Diagnostics	53
Motor identification	53
Settings	53
Power loss ride-through	54
Automatic Start	54

Settings	54
Safe torque off (STO)	55
Diagnostics	55
Prevention of unexpected start-up (POUS)	55
Safely-limited speed (SLS) (AS7R firmware version only)	56
Settings	56
Diagnostics and control	56
DC Magnetising	57
Settings	57
DC Hold	57
Settings	57
Flux Braking	57
Settings	58
Flux Optimisation	58
Settings	58
Acceleration and deceleration ramps	59
Settings	59
Critical speeds	59
Settings	59
Constant speeds	59
Settings	59
Speed controller tuning	60
Settings	60
Diagnostics	60
Speed control performance figures	61
Torque control performance figures	61
Scalar control	62
Settings	62
IR compensation for a scalar controlled drive	62
Settings	62
Hexagonal motor flux	63
Settings	63
Programmable protection functions	63
AI<Min	63
Settings	63
Panel Loss	63
Settings	63
External Fault	63
Settings	63
Motor Thermal Protection	64
Motor temperature thermal model	64
Use of the motor thermistor	64
Settings	64
Stall Protection	65
Settings	65
Underload Protection	65
Settings	65
Motor Phase Loss	65
Settings	65
Earth Fault Protection	66

Settings	66
Communication Fault	66
Settings	66
Supervision of optional IO	66
Settings	66
Preprogrammed faults	66
Overcurrent	66
DC overvoltage	66
DC undervoltage	67
Drive temperature	67
Enhanced drive temperature monitoring for ACS800, frame sizes R7 and R8	67
Settings	68
Diagnostics	68
Short circuit	68
Input phase loss	68
Control board temperature	68
Overfrequency	68
Internal fault	68
Operation limits	68
Settings	68
Power limit	69
Automatic resets	69
Settings	69
Supervisions	69
Settings	69
Diagnostics	69
Parameter lock	69
Settings	69
Process PID control	70
Block diagrams	70
Settings	71
Diagnostics	71
Sleep function for the process PID control	71
Example	72
Settings	72
Diagnostics	72
Motor temperature measurement through the standard I/O	73
Settings	74
Diagnostics	74
Motor temperature measurement through an analogue I/O extension	75
Settings	76
Diagnostics	76
Adaptive Programming using the function blocks	76
DriveAP	76
Control of a mechanical brake	77
Example	77
Operation time scheme	78
State shifts	79
Settings	80
Diagnostics	80

Master/Follower use of several drives	80
Settings and diagnostics	80
Jogging	81
Settings	82
Reduced Run function	82
Settings	82
Diagnostics	82
User load curve	83
Overload	83
Settings	84
Diagnostics	84

Application macros

Chapter overview	85
Overview of macros	85
Note on external power supply	86
Parameter settings	86
Factory macro	87
Default control connections	88
Hand/Auto macro	89
Default control connections	90
PID Control macro	91
Connection example, 24 VDC / 4...20 mA two-wire sensor	91
Default control connections	92
Torque Control macro	93
Default control connections	94
Sequential Control macro	95
Operation diagram	95
Default control connections	96
User macros	97

Actual signals and parameters

Chapter overview	99
Terms and abbreviations	99
01 ACTUAL SIGNALS	100
02 ACTUAL SIGNALS	102
03 ACTUAL SIGNALS	102
04 ACTUAL SIGNALS	103
09 ACTUAL SIGNALS	103
10 START/STOP/DIR	105
11 REFERENCE SELECT	107
12 CONSTANT SPEEDS	113
13 ANALOGUE INPUTS	116
14 RELAY OUTPUTS	119
15 ANALOGUE OUTPUTS	125
16 SYST CTRL INPUTS	127
20 LIMITS	130
21 START/STOP	132

22 ACCEL/DECEL	135
23 SPEED CTRL	138
24 TORQUE CTRL	140
25 CRITICAL SPEEDS	140
26 MOTOR CONTROL	141
27 BRAKE CHOPPER	143
30 FAULT FUNCTIONS	144
31 AUTOMATIC RESET	150
32 SUPERVISION	151
33 INFORMATION	152
34 PROCESS VARIABLE	153
35 MOT TEMP MEAS	155
40 PID CONTROL	157
42 BRAKE CONTROL	162
45 ENERGY OPT	164
50 ENCODER MODULE	165
51 COMM MODULE DATA	166
52 STANDARD MODBUS	166
60 MASTER/FOLLOWER	166
70 DDCS CONTROL	168
72 USER LOAD CURVE	169
83 ADAPT PROG CTRL	171
84 ADAPTIVE PROGRAM	172
85 USER CONSTANTS	173
90 D SET REC ADDR	174
92 D SET TR ADDR	175
95 HARDWARE SPECIF	175
96 EXTERNAL AO	178
98 OPTION MODULES	181
99 START-UP DATA	186

Fieldbus control

Chapter overview	191
System overview	191
Redundant fieldbus control	192
Setting up communication through a fieldbus adapter module	193
Setting up communication through the Standard Modbus Link	195
Modbus addressing	196
Setting up communication through Advant controller	197
Drive control parameters	199
The fieldbus control interface	202
The Control Word and the Status Word	203
References	203
Fieldbus reference selection and correction	203
Reference handling	204
Actual Values	205
Block diagram: Control data input from fieldbus when a type Rxxx fieldbus adapter is used	206
Block diagram: Actual value selection for fieldbus when a type Rxxx fieldbus adapter is used	207
Block diagram: Control data input from fieldbus when a type Nxxx fieldbus adapter is used	208

Block Diagram: Actual value selection for fieldbus when a type Nxxx fieldbus adapter is used	209
Communication profiles	210
ABB Drives communication profile	210
03.01 MAIN CONTROL WORD	211
03.02 MAIN STATUS WORD	212
Fieldbus reference scaling	214
Generic Drive communication profile	215
Drive commands supported by the Generic Drive communication profile	216
Fieldbus reference scaling	217
CSA 2.8/3.0 communication profile	218
CONTROL WORD for the CSA 2.8/3.0 communication profile	218
STATUS WORD for the CSA 2.8/3.0 communication profile	218
Diverse status, fault, alarm and limit words	219
03.03 AUXILIARY STATUS WORD	219
03.04 LIMIT WORD 1	220
03.05 FAULT WORD 1	220
03.06 FAULT WORD 2	221
03.07 SYSTEM FAULT WORD	222
03.08 ALARM WORD 1	222
03.09 ALARM WORD 2	223
03.13 AUXILIARY STATUS WORD 3	223
03.14 AUXILIARY STATUS WORD 4	224
03.15 FAULT WORD 4	224
03.16 ALARM WORD 4	225
03.17 FAULT WORD 5	225
03.18 ALARM WORD 5	226
03.19 INT INIT FAULT	226
03.30 LIMIT WORD INV	227
03.31 ALARM WORD 6	227
03.32 EXT IO STATUS	228
03.33 FAULT WORD 6	228
04.01 FAULTED INT INFO	229
04.02 INT SC INFO	230

Fault tracing

Chapter overview	231
Safety	231
Warning and fault indications	231
How to reset	231
Fault history	231
Warning messages generated by the drive	232
Warning messages generated by the control panel	239
Fault messages generated by the drive	240

Analogue Extension Module

Chapter overview	249
Speed control through the analogue extension module	249
Basic checks	249

Settings of the analogue extension module and the drive	249
Parameter settings: bipolar input in basic speed control	250
Parameter settings: bipolar input in joystick mode	251

Additional data: actual signals and parameters

Chapter overview	253
Terms and abbreviations	253
Fieldbus addresses	253
Rxxx adapter modules (such as RPBA-01, RDNA-01, etc.)	253
Nxxx adapter modules (such as NPBA-12, NDNA-02, etc.)	253
NPBA-12 Profibus Adapter	253
NIBA-01 InterBus-S Adapter	254
NMBP-01 ModbusPlus® Adapter and NMBA-01 Modbus Adapter	254
Actual signals	255
Parameters	258

Control block diagrams

Chapter overview	267
Reference control chain, sheet 1: FACTORY, HAND/AUTO, SEQ CTRL and T CTRL macros (continued on the next page ...)	268
Reference control chain sheet 1: PID CTRL macro (continued on the next page ...)	270
Reference control chain sheet 2: All macros (continued on the next page ...)	272
Handling of Start, Stop, Run Enable and Start Interlock	274
Handling of Reset and On/Off	275

Index

Introduction to the manual

Chapter overview

The chapter includes a description of the contents of the manual. In addition it contains information about the compatibility, safety and intended audience.

Compatibility

The manual is compatible with Standard Control Program versions ASXR7360 and AS7R7363. See parameter [33.01 SOFTWARE VERSION](#).

Safety instructions

Follow all safety instructions delivered with the drive.

- Read the **complete safety instructions** before you install, commission, or use the drive. The complete safety instructions are given at the beginning of the Hardware Manual.
- Read the **software function specific warnings and notes** before changing the default settings of the function. For each function, the warnings and notes are given in this manual in the section describing the related user-adjustable parameters.

Reader

The reader of the manual is expected to know the standard electrical wiring practices, electronic components, and electrical schematic symbols.

Contents

The manual consists of the following chapters:

- [Start-up and control through the I/O](#) instructs in setting up the application program, and how to start, stop and regulate the speed of the drive.
- [Control panel](#) gives instructions for using the panel.
- [Program features](#) contains the feature descriptions and the reference lists of the user settings and diagnostic signals.
- [Application macros](#) contains a short description of each macro together with a connection diagram.
- [Actual signals and parameters](#) describes the actual signals and parameters of the drive.
- [Fieldbus control](#) describes the communication through the serial communication links.

- *Fault tracing* lists the warning and fault messages with the possible causes and remedies.
- *Analogue Extension Module*, describes the communication between the drive and the analogue I/O extension (optional).
- *Additional data: actual signals and parameters* contains more information on the actual signals and parameters.
- *Control block diagrams* contains block diagrams concerning reference control chains and handling of Start, Stop, Run Enable and Start Interlock.

Product and service inquiries

Address any inquiries about the product to your local ABB representative, quoting the type code and serial number of the unit in question. A listing of ABB sales, support and service contacts can be found by navigating to www.abb.com/drives and selecting *Sales, Support and Service network*.

Product training

For information on ABB product training, navigate to www.abb.com/drives and select *Training courses*.

Providing feedback on ABB Drives manuals

Your comments on our manuals are welcome. Go to www.abb.com/drives and select *Document Library – Manuals feedback form (LV AC drives)*.

Start-up and control through the I/O

Chapter overview

The chapter instructs how to:

- do the start-up
- start, stop, change the direction of rotation, and adjust the speed of the motor through the I/O interface
- perform an Identification Run for the drive.

How to start-up the drive

There are two start-up methods between which the user can select: Run the Start-up Assistant, or perform a limited start-up. The Assistant guides the user through all essential settings to be done. In the limited start-up, the drive gives no guidance: The user goes through the very basic settings by following the instructions given in the manual.

- **If you want to run the Assistant**, follow the instructions given in section [How to perform the guided start-up \(covers all essential settings\)](#) on page 15.
- **If you want to perform the limited start-up**, follow the instructions given in section [How to perform the limited start-up \(covers only the basic settings\)](#) on page 17.

How to perform the guided start-up (covers all essential settings)

Before you start, ensure you have the motor nameplate data on hand.

SAFETY	
	<p>The start-up may only be carried out by a qualified electrician.</p> <p>The safety instructions must be followed during the start-up procedure. See the appropriate hardware manual for safety instructions.</p>
<input type="checkbox"/>	<p>Check the installation. See the installation checklist in the appropriate hardware/installation manual.</p>
<input type="checkbox"/>	<p>Check that the starting of the motor does not cause any danger.</p> <p>De-couple the driven machine if:</p> <ul style="list-style-type: none"> - there is a risk of damage in case of incorrect direction of rotation, or - a Standard ID Run needs to be performed during the drive start-up. (ID Run is essential only in applications which require the ultimate in motor control accuracy.)



POWER-UP		
<input type="checkbox"/>	<p>Apply the main power. The control panel first shows the panel identification data ...</p> <p>... then the Identification Display of the drive ...</p> <p>... then the Actual Signal Display ...</p> <p>...after which the display suggests starting the Language Selection. (If no key is pressed for a few seconds, the display starts to alternate between the Actual Signal Display and the suggestion on selecting the language.)</p> <p>The drive is now ready for the start-up.</p>	<pre>CDP312 PANEL Vx.xx ACS800 ID NUMBER 1 1 -> 0.0 rpm 0 FREQ 0.00 Hz CURRENT 0.00 A POWER 0.00 % 1 -> 0.0 rpm 0 *** INFORMATION *** Press FUNC to start Language Selection</pre>
SELECTING THE LANGUAGE		
<input type="checkbox"/>	<p>Press the FUNC key.</p>	<pre>Language Selection 1/1 LANGUAGE ? [ENGLISH] ENTER:OK ACT:EXIT</pre>
<input type="checkbox"/>	<p>Scroll to the desired language by the arrow keys (▲ or ▼) and press ENTER to accept.</p> <p>(The drive loads the selected language into use, shifts back to the Actual Signal Display and starts to alternate between the Actual Signal Display and the suggestion on starting the guided motor set-up.)</p>	<pre>1 -> 0.0 rpm 0 *** INFORMATION *** Press FUNC to start guided Motor Setup</pre>
STARTING THE GUIDED MOTOR SET-UP		
<input type="checkbox"/>	<p>Press FUNC to start the guided motor set-up.</p> <p>(The display shows which general command keys to use when stepping through the assistant.)</p>	<pre>Motor Setup 1/10 ENTER: Ok/Continue ACT: Exit FUNC: More Info</pre>
<input type="checkbox"/>	<p>Press ENTER to step forward.</p> <p>Follow the instructions given on the display.</p>	<pre>Motor Setup 2/10 MOTOR NAMEPLATE DATA AVAILABLE? ENTER:Yes FUNC:Info</pre>

How to perform the limited start-up (covers only the basic settings)

Before you start, ensure you have the motor nameplate data at your hand.

SAFETY			
	<p>The start-up may only be carried out by a qualified electrician.</p> <p>The safety instructions must be followed during the start-up procedure. See the appropriate hardware manual for safety instructions.</p>		
<input type="checkbox"/>	<p>Check the installation. See the installation checklist in the appropriate hardware/installation manual.</p>		
<input type="checkbox"/>	<p>Check that the starting of the motor does not cause any danger.</p> <p>De-couple the driven machine if:</p> <ul style="list-style-type: none"> - there is a risk of damage in case of incorrect direction of rotation, or - a Standard ID Run needs to be performed during the drive start-up. (ID Run is essential only in applications which require the ultimate in motor control accuracy.) 		
POWER-UP			
<input type="checkbox"/>	<table border="0" style="width: 100%;"> <tr> <td style="vertical-align: top;"> <p>Apply the main power. The control panel first shows the panel identification data ...</p> <p>... then the Identification Display of the drive ...</p> <p>... then the Actual Signal Display ...</p> <p>...after which the display suggests starting the Language Selection. (If no key is pressed for a few seconds, the display starts to alternate between the Actual Signal Display and the suggestion on starting the Language Selection.)</p> <p>Press ACT to remove the suggestion on starting the language selection.</p> <p>The drive is now ready for the limited start-up.</p> </td> <td style="vertical-align: top; font-family: monospace; padding-left: 20px;"> <pre> CDP312 PANEL Vx.xx ACS800 ID NUMBER 1 1 -> 0.0 rpm 0 FREQ 0.00 Hz CURRENT 0.00 A POWER 0.00 % 1 -> 0.0 rpm 0 *** INFORMATION *** Press FUNC to start Language Selection 1 -> 0.0 rpm 0 FREQ 0.00 Hz CURRENT 0.00 A POWER 0.00 % </pre> </td> </tr> </table>	<p>Apply the main power. The control panel first shows the panel identification data ...</p> <p>... then the Identification Display of the drive ...</p> <p>... then the Actual Signal Display ...</p> <p>...after which the display suggests starting the Language Selection. (If no key is pressed for a few seconds, the display starts to alternate between the Actual Signal Display and the suggestion on starting the Language Selection.)</p> <p>Press ACT to remove the suggestion on starting the language selection.</p> <p>The drive is now ready for the limited start-up.</p>	<pre> CDP312 PANEL Vx.xx ACS800 ID NUMBER 1 1 -> 0.0 rpm 0 FREQ 0.00 Hz CURRENT 0.00 A POWER 0.00 % 1 -> 0.0 rpm 0 *** INFORMATION *** Press FUNC to start Language Selection 1 -> 0.0 rpm 0 FREQ 0.00 Hz CURRENT 0.00 A POWER 0.00 % </pre>
<p>Apply the main power. The control panel first shows the panel identification data ...</p> <p>... then the Identification Display of the drive ...</p> <p>... then the Actual Signal Display ...</p> <p>...after which the display suggests starting the Language Selection. (If no key is pressed for a few seconds, the display starts to alternate between the Actual Signal Display and the suggestion on starting the Language Selection.)</p> <p>Press ACT to remove the suggestion on starting the language selection.</p> <p>The drive is now ready for the limited start-up.</p>	<pre> CDP312 PANEL Vx.xx ACS800 ID NUMBER 1 1 -> 0.0 rpm 0 FREQ 0.00 Hz CURRENT 0.00 A POWER 0.00 % 1 -> 0.0 rpm 0 *** INFORMATION *** Press FUNC to start Language Selection 1 -> 0.0 rpm 0 FREQ 0.00 Hz CURRENT 0.00 A POWER 0.00 % </pre>		
MANUAL START-UP DATA ENTERING (parameter group 99)			
<input type="checkbox"/>	<table border="0" style="width: 100%;"> <tr> <td style="vertical-align: top;"> <p>Select the language. The general parameter setting procedure is described below.</p> <p>The general parameter setting procedure:</p> <ul style="list-style-type: none"> - Press PAR to select the Parameter Mode of the panel. - Press the double-arrow keys (▲ or ▼) to scroll the parameter groups. - Press the arrow keys (⬆ or ⬇) to scroll parameters within a group. - Activate the setting of a new value by ENTER. - Change the value by the arrow keys (⬆ or ⬇), fast change by the double-arrow keys (▲ or ▼). - Press ENTER to accept the new value (brackets disappear). </td> <td style="vertical-align: top; font-family: monospace; padding-left: 20px;"> <pre> 1 -> 0.0 rpm 0 99 START-UP DATA 01 LANGUAGE ENGLISH 1 -> 0.0 rpm 0 99 START-UP DATA 01 LANGUAGE [ENGLISH] </pre> </td> </tr> </table>	<p>Select the language. The general parameter setting procedure is described below.</p> <p>The general parameter setting procedure:</p> <ul style="list-style-type: none"> - Press PAR to select the Parameter Mode of the panel. - Press the double-arrow keys (▲ or ▼) to scroll the parameter groups. - Press the arrow keys (⬆ or ⬇) to scroll parameters within a group. - Activate the setting of a new value by ENTER. - Change the value by the arrow keys (⬆ or ⬇), fast change by the double-arrow keys (▲ or ▼). - Press ENTER to accept the new value (brackets disappear). 	<pre> 1 -> 0.0 rpm 0 99 START-UP DATA 01 LANGUAGE ENGLISH 1 -> 0.0 rpm 0 99 START-UP DATA 01 LANGUAGE [ENGLISH] </pre>
<p>Select the language. The general parameter setting procedure is described below.</p> <p>The general parameter setting procedure:</p> <ul style="list-style-type: none"> - Press PAR to select the Parameter Mode of the panel. - Press the double-arrow keys (▲ or ▼) to scroll the parameter groups. - Press the arrow keys (⬆ or ⬇) to scroll parameters within a group. - Activate the setting of a new value by ENTER. - Change the value by the arrow keys (⬆ or ⬇), fast change by the double-arrow keys (▲ or ▼). - Press ENTER to accept the new value (brackets disappear). 	<pre> 1 -> 0.0 rpm 0 99 START-UP DATA 01 LANGUAGE ENGLISH 1 -> 0.0 rpm 0 99 START-UP DATA 01 LANGUAGE [ENGLISH] </pre>		

- Select the Application Macro. The general parameter setting procedure is given above.

The default value FACTORY is suitable in most cases.

- Select the motor control mode. The general parameter setting procedure is given above.

DTC is suitable in most cases. The SCALAR control mode is recommended

- for multimotor drives when the number of the motors connected to the drive is variable
- when the nominal current of the motor is less than 1/6 of the nominal current of the inverter
- when the inverter is used for test purposes with no motor connected.

- Enter the motor data from the motor nameplate:

v		Hz	kW	r/min	A	cos φ	I _A /I _N	t _E /s
690 Y	50	30	1475	32.5	0.83			
400 D	50	30	1475	56	0.83			
660 Y	50	30	1470	34	0.83			
380 D	50	30	1470	59	0.83			
415 D	50	30	1475	54	0.83			
440 D	60	35	1770	59	0.83			

380 V input voltage

- motor nominal voltage

Allowed range: $1/2 \cdot U_N \dots 2 \cdot U_N$ of ACS800. (U_N refers to the highest voltage in each of the nominal voltage ranges: 415 VAC for 400 VAC units, 500 VAC for 500 VAC units and 690 VAC for 600 VAC units.)

- motor nominal current

Allowed range: approx. $1/6 \cdot I_{2hd} \dots 2 \cdot I_{2hd}$ of ACS800 ($0 \dots 2 \cdot I_{2hd}$ if parameter 99.04 = SCALAR)

- motor nominal frequency

Range: 8 ... 300 Hz

- motor nominal speed

Range: 1 ... 18000 rpm

- motor nominal power

Range: 0 ... 9000 kW

```
1 -> 0.0 rpm 0
99 START-UP DATA
02 APPLICATION MACRO
[ ]
```

```
1 -> 0.0 rpm 0
99 START-UP DATA
04 MOTOR CTRL MODE
[DTC]
```

Note: Set the motor data to exactly the same value as on the motor nameplate. For example, if the motor nominal speed is 1440 rpm on the nameplate, setting the value of parameter 99.08 MOTOR NOM SPEED to 1500 rpm results in the wrong operation of the drive.

```
1 -> 0.0 rpm 0
99 START-UP DATA
05 MOTOR NOM VOLTAGE
[ ]
```

```
1 -> 0.0 rpm 0
99 START-UP DATA
06 MOTOR NOM CURRENT
[ ]
```

```
1 -> 0.0 rpm 0
99 START-UP DATA
07 MOTOR NOM FREQ
[ ]
```

```
1 -> 0.0 rpm 0
99 START-UP DATA
08 MOTOR NOM SPEED
[ ]
```

```
1 -> 0.0 rpm 0
99 START-UP DATA
09 MOTOR NOM POWER
[ ]
```

	<p>When the motor data has been entered, two displays (warning and information) start to alternate. Move to next step without pressing any key.</p> <p>Note: If you select STANDARD ID Run, the brake is opened when the Start command is given from the control panel and the brake remains open until the STANDARD ID Run is completed. If you select ID MAGN, the brake is kept closed during the ID Run sequence.</p>	<pre> 1 -> 0.0 rpm O ACS800 ** WARNING ** ID MAGN REQ 1 -> 0.0 rpm I *** Information *** Press green button to start ID MAGN </pre>
<input type="checkbox"/>	<p>Select the motor identification method.</p> <p>The default value ID MAGN (ID Magnetisation) is suitable for most applications. It is applied in this basic start-up procedure. If your selection is ID Magnetisation, move to next step without pressing any key.</p> <p>The ID Run (STANDARD or REDUCED) should be selected if:</p> <ul style="list-style-type: none"> - The operation point is near zero speed constantly, and/or - Operation at torque range above the motor nominal torque within a wide speed range and without any measured speed feedback is required. <p>If your selection is ID Run, continue by following the separate instructions given a few pages ahead in section How to perform the ID Run on page 22.</p>	
IDENTIFICATION MAGNETISATION (with Motor ID Run selection ID MAGN)		
<input type="checkbox"/>	<p>Press the LOC/REM key to change to local control (L shown on the first row).</p> <p>Press  to start the Identification Magnetisation. The motor is magnetised at zero speed for 20 to 60 s. Three warnings are displayed:</p> <p>The first warning is displayed when the magnetisation starts.</p> <p>The second warning is displayed while the magnetisation is on.</p> <p>The third warning is displayed after the magnetisation is completed.</p>	<pre> 1 L -> 1242.0 rpm I ** WARNING ** MOTOR STARTS 1 L-> 0.0 rpm I ** WARNING ** ID MAGN 1 L-> 0.0 rpm O ** WARNING ** ID DONE </pre>

DIRECTION OF ROTATION OF THE MOTOR

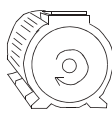
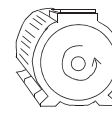
□	<p>Check the direction of rotation of the motor.</p> <ul style="list-style-type: none"> - Press ACT to get the status row visible. - Increase the speed reference from zero to a small value by pressing REF and then the arrow keys (▲, ▼, ▲ or ▼). - Press ⏻ to start the motor. - Check that the motor is running in the desired direction. - Stop the motor by pressing ⏹. <p>To change the direction of rotation of the motor:</p> <ul style="list-style-type: none"> - Disconnect the main power from the drive, and wait 5 minutes for the intermediate circuit capacitors to discharge. Measure the voltage between each input terminal (U1, V1 and W1) and earth with a multimeter to ensure that the frequency converter is discharged. - Exchange the position of two motor cable phase conductors at the motor terminals or at the motor connection box. - Verify your work by applying the main power and repeating the check as described above. 	<pre> 1 L-> [xxx] rpm I FREQ xxx Hz CURRENT xx A POWER xx % </pre> <div style="display: flex; justify-content: space-around; align-items: center;"> <div style="text-align: center;">  <p>forward direction</p> </div> <div style="text-align: center;">  <p>reverse direction</p> </div> </div>
---	--	--

SPEED LIMITS AND ACCELERATION/DECELERATION TIMES

□	Set the minimum speed.	<pre> 1 L-> 0.0 rpm 0 20 LIMITS 01 MINIMUM SPEED [] </pre>
□	Set the maximum speed.	<pre> 1 L-> 0.0 rpm 0 20 LIMITS 02 MAXIMUM SPEED [] </pre>
□	Set the acceleration time 1. Note: Check also acceleration time 2, if two acceleration times will be used in the application.	<pre> 1 L-> 0.0 rpm 0 22 ACCEL/DECEL 02 ACCELER TIME 1 [] </pre>
□	Set the deceleration time 1. Note: Set also deceleration time 2, if two deceleration times will be used in the application.	<pre> 1 L-> 0.0 rpm 0 22 ACCEL/DECEL 03 DECELER TIME 1 [] </pre>

The drive is now ready for use.

How to control the drive through the I/O interface

The table below instructs how to operate the drive through the digital and analogue inputs, when:

- the motor start-up is performed, and
- the default (factory) parameter settings are valid.

PRELIMINARY SETTINGS	
Ensure the Factory macro is active.	See parameter 99.02 .
If you need to change the direction of rotation, change the setting of parameter 10.03 to REQUEST.	
Ensure the control connections are wired according to the connection diagram given for the Factory macro.	See chapter Application macros .
Ensure the drive is in external control mode. Press the LOC/REM key to change between external and local control.	In External control, there is no L visible on the first row of the panel display.
STARTING AND CONTROLLING THE SPEED OF THE MOTOR	
Start by switching digital input DI1 on.	1 -> 0.0 rpm I FREQ 0.00 Hz CURRENT 0.00 A POWER 0.00 %
Regulate the speed by adjusting the voltage of analogue input AI1.	1 -> 500.0 rpm I FREQ 16.66 Hz CURRENT 12.66 A POWER 8.33 %
CHANGING THE DIRECTION OF ROTATION OF THE MOTOR	
Forward direction: Switch digital input DI2 off.	1 -> 500.0 rpm I FREQ 16.66 Hz CURRENT 12.66 A POWER 8.33 %
Reverse direction: Switch digital input DI2 on.	1 <- 500.0 rpm I FREQ 16.66 Hz CURRENT 12.66 A POWER 8.33 %
STOPPING THE MOTOR	
Switch off digital input DI1.	1 -> 500.0 rpm O FREQ 0.00 Hz CURRENT 0.00 A POWER 0.00 %

How to perform the ID Run

The drive performs the ID Magnetisation automatically at the first start. In most applications there is no need to perform a separate ID Run. The ID Run (Standard or Reduced) should be selected if:

- The operation point is near zero speed, and/or
- Operation at torque range above the motor nominal torque within a wide speed range and without any measured speed feedback is required.

The Reduced ID Run is to be performed instead of the Standard if it is not possible to disengage the driven machine from the motor.

Note: If you select STANDARD ID Run, the brake is opened when the Start command is given from the control panel and the brake remains open until the STANDARD ID Run is completed. If you select ID MAGN, the brake is kept closed during the ID Run sequence.

ID Run Procedure

Note: If parameter values (Group 10 to 98) are changed before the ID Run, check that the new settings meet the following conditions:

- 20.01 MINIMUM SPEED ≤ 0 rpm
- 20.02 MAXIMUM SPEED $> 80\%$ of motor rated speed
- 20.03 MAXIMUM CURRENT $\geq 100\% \cdot I_{hd}$
- 20.04 MAXIMUM TORQUE $> 50\%$

-
- Ensure that the panel is in the local control mode (L displayed on the status row). Press the **LOC/REM** key to switch between modes.
 - Change the ID Run selection to STANDARD or REDUCED.

```

1 L ->1242.0 rpm      O
99 START-UP DATA
10 MOTOR ID RUN
[STANDARD]
  
```

- Press **ENTER** to verify selection. The following message will be displayed:



```

1 L ->1242.0 rpm      O
ACS800
**WARNING**
ID RUN SEL
  
```

- To start the ID Run, press the  key. The Start Interlock (digital input DI_IL) and Run Enable signals (parameter 16.01 RUN ENABLE) must be active.

Warning when the ID Run is started	Warning during the ID Run	Warning after a successfully completed ID Run
1 L -> 1242.0 rpm I ACS800 **WARNING** MOTOR STARTS	1 L -> 1242.0 rpm I ACS800 **WARNING** ID RUN	1 L -> 1242.0 rpm I ACS800 **WARNING** ID DONE

In general it is recommended not to press any control panel keys during the ID run. However:

- The Motor ID Run can be stopped at any time by pressing the control panel stop key ().
- After the ID Run is started with the start key () , it is possible to monitor the actual values by first pressing the **ACT** key and then a double-arrow key ().

www.nicsanat.com

021-87700210

NIC SANAT

نیک صنعت



Control panel

Chapter overview

The chapter describes how to use the control panel CDP 312R.

The same control panel is used with all ACS800 series drives, so the instructions given apply to all ACS800 types. The display examples shown are based on the Standard Control Program; displays produced by other application programs may differ slightly.

Overview of the panel

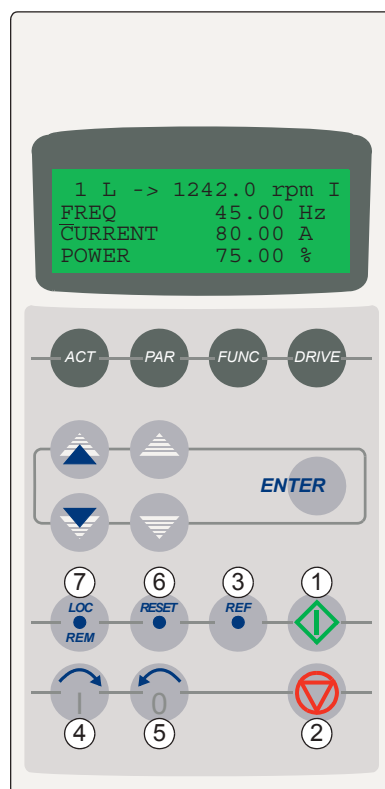

The LCD type display has 4 lines of 20 characters.

The language is selected at start-up (parameter [99.01](#)).

The control panel has four operation modes:

- Actual Signal Display Mode (ACT key)
- Parameter Mode (PAR key)
- Function Mode (FUNC key)
- Drive Selection Mode (DRIVE key)

The use of single arrow keys, double arrow keys and ENTER depend on the operation mode of the panel.

The drive control keys are:

No.	Use
1	Start
2	Stop
3	Activate reference setting
4	Forward direction of rotation
5	Reverse direction of rotation
6	Fault reset
7	Change between Local / Remote (external) control

Panel operation mode keys and displays

The figure below shows the mode selection keys of the panel, and the basic operations and displays in each mode.

Actual Signal Display Mode

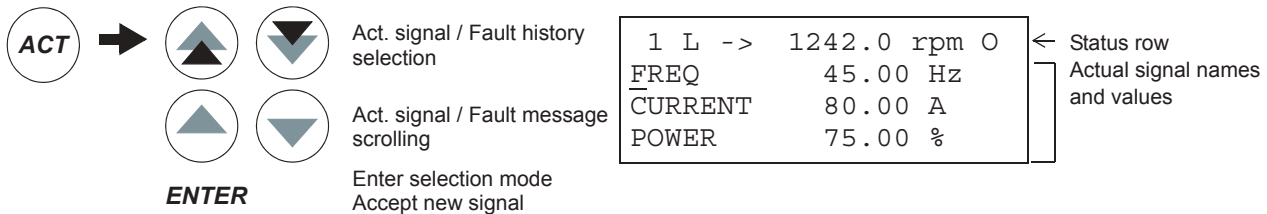

Parameter Mode

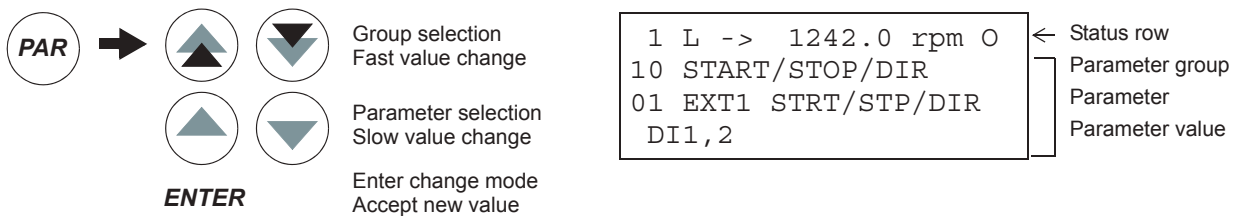

Function Mode

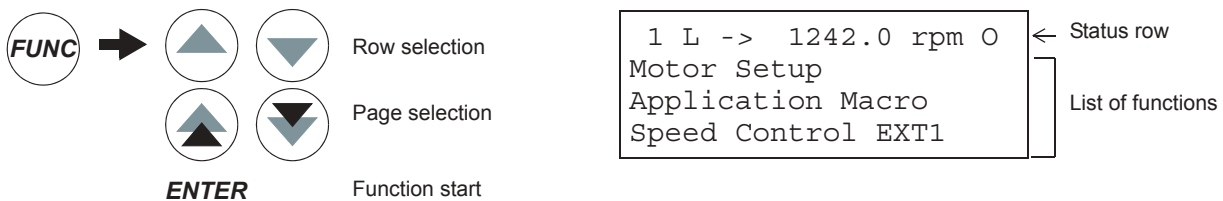

Drive Selection Mode

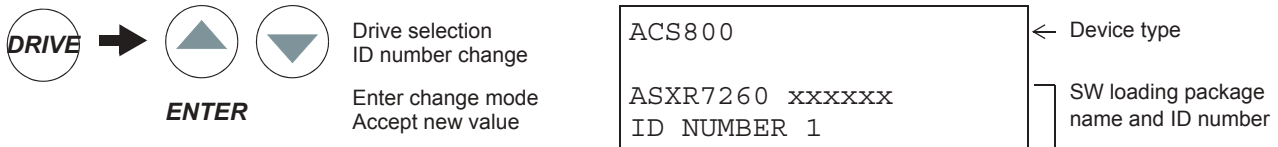

Status row

The figure below describes the status row digits.

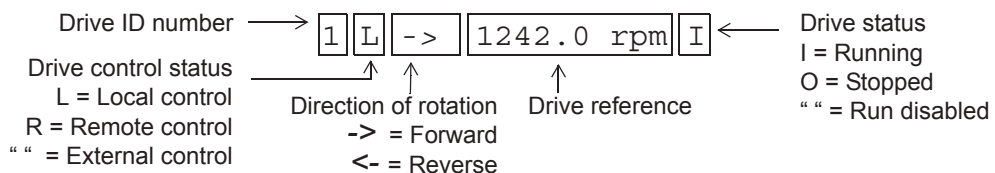







Drive control with the panel

The user can control the drive with the panel as follows:

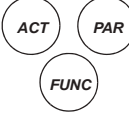
- start, stop, and change direction of the motor
- give the motor speed reference or torque reference
- give a process reference (when the process PID control is active)
- reset the fault and warning messages
- change between local and external drive control.









The panel can be used for control of the drive control always when the drive is under local control and the status row is visible on the display.

How to start, stop and change direction

Step	Action	Press Key	Display
1.	To show the status row.		1 L ->1242.0 rpm I FREQ 45.00 Hz CURRENT 80.00 A POWER 75.00 %
2.	To switch to local control. (only if the drive is not under local control, i.e. there is no L on the first row of the display.)		1 L ->1242.0 rpm I FREQ 45.00 Hz CURRENT 80.00 A POWER 75.00 %
3.	To stop		1 L ->1242.0 rpm O FREQ 45.00 Hz CURRENT 80.00 A POWER 75.00 %
4.	To start		1 L ->1242.0 rpm I FREQ 45.00 Hz CURRENT 80.00 A POWER 75.00 %
5.	To change the direction to reverse.		1 L <-1242.0 rpm I FREQ 45.00 Hz CURRENT 80.00 A POWER 75.00 %
6.	To change the direction to forward.		1 L ->1242.0 rpm I FREQ 45.00 Hz CURRENT 80.00 A POWER 75.00 %



How to set speed reference

Step	Action	Press Key	Display
1.	To show the status row.	  	1 ->1242.0 rpm I FREQ 45.00 Hz CURRENT 80.00 A POWER 75.00 %
2.	To switch to local control. (Only if the drive is not under local control, i.e. there is no L on the first row of the display.)		1 L ->1242.0 rpm I FREQ 45.00 Hz CURRENT 80.00 A POWER 75.00 %
3.	To enter the Reference Setting function.		1 L ->[1242.0 rpm] I FREQ 45.00 Hz CURRENT 80.00 A POWER 75.00 %
4.	To change the reference. (slow change) (fast change)	   	1 L ->[1325.0 rpm] I FREQ 45.00 Hz CURRENT 80.00 A POWER 75.00 %
5.	To save the reference. (The value is stored in the permanent memory; it is restored automatically after power switch-off.)	ENTER	1 L -> 1325.0 rpm I FREQ 45.00 Hz CURRENT 80.00 A POWER 75.00 %

Actual signal display mode

In the Actual Signal Display Mode, the user can:



- show three actual signals on the display at a time
- select the actual signals to display
- view the fault history
- reset the fault history.

The panel enters the Actual Signal Display Mode when the user presses the **ACT** key, or if he does not press any key within one minute.

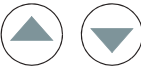
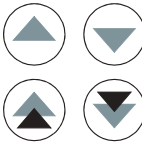
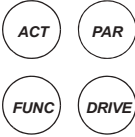
How to select actual signals to the display





Step	Action	Press key	Display
1.	To enter the Actual Signal Display Mode.		1 L -> 1242.0 rpm I FREQ 45.00 Hz CURRENT 80.00 A POWER 75.00 %
2.	To select a row (a blinking cursor indicates the selected row).		1 L -> 1242.0 rpm I FREQ 45.00 Hz CURRENT 80.00 A POWER 75.00 %
3.	To enter the actual signal selection function.	ENTER	1 L -> 1242.0 rpm I 1 ACTUAL SIGNALS 04 CURRENT 80.00 A
4.	To select an actual signal. To change the actual signal group.		1 L -> 1242.0 rpm I 1 ACTUAL SIGNALS 05 TORQUE 70.00 %
5.a	To accept the selection and to return to the Actual Signal Display Mode.	ENTER	1 L -> 1242.0 rpm I FREQ 45.00 Hz TORQUE 70.00 % POWER 75.00 %
5.b	To cancel the selection and keep the original selection. The selected keypad mode is entered.		1 L -> 1242.0 rpm I FREQ 45.00 Hz CURRENT 80.00 A POWER 75.00 %

How to display the full name of the actual signals

Step	Action	Press key	Display
1.	To display the full name of the three actual signals.	Hold 	1 L -> 1242.0 rpm I FREQUENCY CURRENT POWER
2.	To return to the Actual Signal Display Mode.	Release 	1 L -> 1242.0 rpm I FREQ 45.00 Hz CURRENT 80.00 A POWER 75.00 %

How to view and reset the fault history



Note: The fault history cannot be reset if there are active faults or warnings.

Step	Action	Press key	Display
1.	To enter the Actual Signal Display Mode.		1 L -> 1242.0 rpm I FREQ 45.00 Hz CURRENT 80.00 A POWER 75.00 %
2.	To enter the Fault History Display.		1 L -> 1242.0 rpm I 1 LAST FAULT +OVERCURRENT 6451 H 21 MIN 23 S
3.	To select the previous (UP) or the next fault/warning (DOWN). To clear the Fault History.	 	1 L -> 1242.0 rpm I 2 LAST FAULT +OVERVOLTAGE 1121 H 1 MIN 23 S 1 L -> 1242.0 rpm I 2 LAST FAULT H MIN S
4.	To return to the Actual Signal Display Mode.		1 L -> 1242.0 rpm I FREQ 45.00 Hz CURRENT 80.00 A POWER 75.00 %

How to display and reset an active fault



WARNING! If an external source for start command is selected and it is ON, the drive will start immediately after fault reset. If the cause of the fault has not been removed, the drive will trip again.

Step	Action	Press Key	Display
1.	To display an active fault.		1 L -> 1242.0 rpm ACS800 ** FAULT ** ACS800 TEMP
2.	To reset the fault.		1 L -> 1242.0 rpm 0 FREQ 45.00 Hz CURRENT 80.00 A POWER 75.00 %

About the fault history

The fault history restores information on the latest events (faults, warnings and resets) of the drive. The table below shows how the events are stored in the fault history.

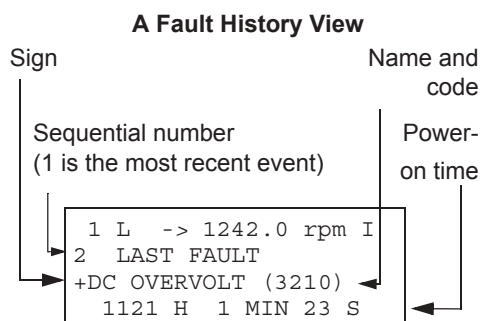

Event	Information on display
Drive detects a fault and generates a fault message	Sequential number of the event and LAST FAULT text. Name of the fault and a "+" sign in front of the name. Total power-on time.
User resets the fault message.	Sequential number of the event and LAST FAULT text. -RESET FAULT text. Total power-on time.
Drive generates a warning message.	Sequential number of the event and LAST WARNING text. Name of the warning and a "+" sign in front of the name. Total power-on time.
Drive deactivates the warning message.	Sequential number of the event and LAST WARNING text. Name of the warning and a "-" sign in front of the name. Total power-on time.













Parameter mode

In the Parameter Mode, the user can:

- view the parameter values
- change the parameter settings.









The panel enters the Parameter Mode when the user presses the **PAR** key.

How to select a parameter and change the value

Step	Action	Press key	Display
1.	To enter the Parameter Mode.		1 L -> 1242.0 rpm O 10 START/STOP/DIR 01 EXT1 STRT/STP/DIR DI1,2
2.	To select a group.	 	1 L -> 1242.0 rpm O 11 REFERENCE SELECT 01 KEYPAD REF SEL REF1 (rpm)
3.	To select a parameter within a group.	 	1 L -> 1242.0 rpm O 11 REFERENCE SELECT 03 EXT REF1 SELECT AI1
4.	To enter the parameter setting function.	ENTER	1 L -> 1242.0 rpm O 11 REFERENCE SELECT 03 EXT REF1 SELECT [AI1]
5.	To change the parameter value. - (slow change for numbers and text) - (fast change for numbers only)	   	1 L -> 1242.0 rpm O 11 REFERENCE SELECT 03 EXT REF1 SELECT [AI2]
6a.	To save the new value.	ENTER	1 L -> 1242.0 rpm O 11 REFERENCE SELECT 03 EXT REF1 SELECT AI2
6b.	To cancel the new setting and keep the original value, press any of the mode selection keys. The selected mode is entered.	   	1 L -> 1242.0 rpm O 11 REFERENCE SELECT 03 EXT REF1 SELECT AI1

How to adjust a source selection (pointer) parameter

Most parameters define values that are used directly in the drive application program. Source selection (pointer) parameters are exceptions: They point to the value of another parameter. The parameter setting procedure differs somewhat from that of the other parameters.

Step	Action	Press Key	Display
1.	See the table above to - enter the Parameter Mode - select the correct parameter group and parameter - enter the parameter setting mode	     ENTER	1 L ->1242.0 rpm 0 84 ADAPTIVE PROGRAM 06 INPUT1 [±000.000.00]
2.	To scroll between the inversion, group, index and bit fields. ¹⁾	 	1 L ->1242.0 rpm 0 84 ADAPTIVE PROGRAM 06 INPUT1 [±000. <u>000</u> .00]
3.	To adjust the value of a field.	 	1 L ->1242.0 rpm 0 84 ADAPTIVE PROGRAM 06 INPUT1 [±000. <u>018</u> .00]
4.	To accept the value.	ENTER	

1)

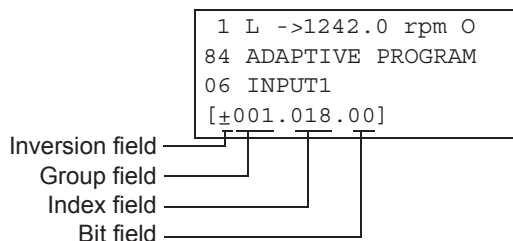

Inversion field inverts the selected parameter value. Plus sign (+): no inversion, minus (-) sign: inversion.

Bit field selects the bit number (relevant only if the parameter value is a packed boolean word).

Index field selects the parameter index.

Group field selects the parameter group.

Note: Instead of pointing to another parameter, it is also possible to define a constant by the source selection parameter. Proceed as follows:

- Change the inversion field to C. The appearance of the row changes. The rest of the line is now a constant setting field.
- Give the constant value to the constant setting field.
- Press Enter to accept.

Function mode

In the Function Mode, the user can:

- start a guided procedure for adjusting the drive settings (assistants)
- upload the drive parameter values and motor data from the drive to the panel.
- download group 1 to 97 parameter values from the panel to the drive. ¹⁾
- adjust the contrast of the display.



The panel enters the Function Mode when the user presses the **FUNC** key.

¹⁾ The parameter groups 98, 99 and the results of the motor identification are not included by default. The restriction prevents downloading of unfit motor data. In special cases it is, however, possible to download all. For more information, please contact your local ABB representative.

How to enter an assistant, browse and exit

The table below shows the operation of the basic keys which lead the user through an assistant. The Motor Setup task of the Start-up Assistant is used as an example.

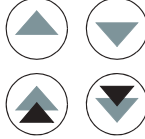
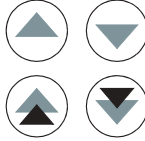
The Start-up Assistant is not available in Scalar mode or when the parameter lock is on. (99.04 MOTOR CTRL MODE = SCALAR or 16.02 PARAMETER LOCK = LOCKED or 16.10 ASSIST SEL = OFF)

Step	Action	Press Key	Display
1.	To enter the Function Mode.		1 L -> 1242.0 rpm 0 Motor Setup Application Macro Speed Control EXT1
2.	To select a task or function from the list (a flashing cursor indicates the selection). Double arrows: To change page to see more assistants/ functions.		1 L -> 1242.0 rpm 0 Motor Setup Application Macro Speed Control EXT 1
3.	To enter the task.	ENTER	Motor Setup 1/10 ENTER: Ok/Continue ACT: Exit FUNC: More Info
4.	To accept and continue.	ENTER	Motor Setup 2/10 MOTOR NAMEPLATE DATA AVAILABLE? ENTER:Yes FUNC:Info
5.	To accept and continue.	ENTER	Motor Setup 3/10 MOTOR NOM VOLTAGE? [0 V] ENTER:Ok RESET:Back
6.	a. To adjust the requested drive parameter. b. To ask for information on the requested value. (To scroll the information displays and return to the task).	 FUNC  FUNC, ACT	Motor Setup 3/10 MOTOR NOM VOLTAGE? [415 V] ENTER:Ok RESET:back INFO P99.05 Set as given on the motor nameplate. ▲
7.	a. To accept a value and step forward. b. To cancel the setting and take one step back.	ENTER RESET	Motor Setup 4/10 MOTOR NOM CURRENT? [0.0 A] ENTER:Ok RESET:Back Motor Setup 3/10 MOTOR NOM VOLTAGE? [415 V] ENTER:Ok RESET:back

Step	Action	Press Key	Display
8.	To cancel and exit. Note: 1 x ACT returns to the first display of the task.	2 x ACT	1 L -> 0.0 rpm 0 FREQ 0.00 Hz CURRENT 0.00 A POWER 0.00 %

How to upload data from a drive to the panel

Note:





- Upload before downloading.
- Ensure the firmware of the destination drive is the same (e.g. standard firmware).
- Before removing the panel from a drive, ensure the panel is in remote operating mode (change with the LOC/REM key).
- Stop the drive before downloading.

Before upload, repeat the following steps in each drive:

- Setup the motors.
- Activate the communication to the optional equipment. (See parameter group [98 OPTION MODULES](#).)

Before upload, do the following in the drive from which the copies are to be taken:





- Set the parameters in groups 10 to 97 as preferred.
- Proceed to the upload sequence (below).

Step	Action	Press Key	Display
1.	Enter the Function Mode.		1 L -> 1242.0 rpm 0 Motor Setup Application Macro Speed Control EXT1
2.	Enter the page that contains the upload, download and contrast functions.		1 L -> 1242.0 rpm 0 UPLOAD <=<= DOWNLOAD =>=> CONTRAST 4
3.	Select the upload function (a flashing cursor indicates the selected function).	 	1 L -> 1242.0 rpm 0 UPLOAD <=<= DOWNLOAD =>=> CONTRAST 4
4.	Enter the upload function.	ENTER	1 L -> 1242.0 rpm 0 UPLOAD <=<=
5.	Switch to external control. (No L on the first row of the display.)		1 -> 1242.0 rpm 0 UPLOAD <=<= DOWNLOAD =>=> CONTRAST 4











Step	Action	Press Key	Display
6.	Disconnect the panel and reconnect it to the drive into which the data will be downloaded.		

How to download data from the panel to a drive

Consider the notes in section [How to upload data from a drive to the panel](#) on page 36.

Step	Action	Press Key	Display
1.	Connect the panel containing the uploaded data to the drive.		
2.	Ensure the drive is in local control (L shown on the first row of the display). If necessary, press the LOC/REM key to change to local control.		1 L -> 1242.0 rpm I FREQ 45.00 Hz CURRENT 80.00 A POWER 75.00 %
3.	Enter the Function Mode.		1 L -> 1242.0 rpm O Motor Setup Application Macro Speed Control EXT1
4.	Enter the page that contains the upload, download and contrast functions.		1 L -> 1242.0 rpm O UPLOAD <=<=<=<= DOWNLOAD =>=>=>=> CONTRAST 4
5.	Select the download function (a flashing cursor indicates the selected function).	 	1 L -> 1242.0 rpm O UPLOAD <=<=<=<= DOWNLOAD =>=>=>=> CONTRAST 4
6.	Start the download.	ENTER	1 L -> 1242.0 rpm O DOWNLOAD =>=>=>=>

How to set the contrast of the display

Step	Action	Press Key	Display
1.	Enter the Function Mode.		1 L -> 1242.0 rpm O Motor Setup Application Macro Speed Control EXT1
2.	Enter the page that contains the upload, download and contrast functions.		1 L -> 1242.0 rpm O U <u>P</u> LOAD <=<=<= D <u>O</u> WNL <u>O</u> A <u>D</u> =>=>=> C <u>O</u> N <u>T</u> R <u>A</u> S <u>T</u> 4
3.	Select a function (a flashing cursor indicates the selected function).	 	1 L -> 1242.0 rpm O U <u>P</u> LOAD <=<=<= D <u>O</u> WNL <u>O</u> A <u>D</u> =>=>=> C <u>O</u> N <u>T</u> R <u>A</u> S <u>T</u> 4
4.	Enter the contrast setting function.	ENTER	1 L -> 1242.0 rpm O C <u>O</u> N <u>T</u> R <u>A</u> S <u>T</u> [4]
5.	Adjust the contrast.	 	1 L -> 1242.0 rpm C <u>O</u> N <u>T</u> R <u>A</u> S <u>T</u> [6]
6.a	Accept the selected value.	ENTER	1 L -> 1242.0 rpm O U <u>P</u> LOAD <=<=<= D <u>O</u> WNL <u>O</u> A <u>D</u> =>=>=> C <u>O</u> N <u>T</u> R <u>A</u> S <u>T</u> 6
6.b	Cancel the new setting and retain the original value by pressing any of the mode selection keys. The selected mode is entered.	   	1 L -> 1242.0 rpm I F <u>R</u> E <u>Q</u> 45.00 Hz C <u>U</u> R <u>R</u> E <u>N</u> T 80.00 A P <u>O</u> W <u>E</u> R 75.00 %

Drive selection mode

In normal use the features available in the Drive Selection Mode are not needed; the features are reserved for applications where several drives are connected to one panel link. (For more information, see the *Installation and Start-up Guide for the Panel Bus Connection Interface Module, NBCI*, [3AFY58919748 (English)]).

In the Drive Selection Mode, the user can:



- Select the drive with which the panel communicates through the panel link.
- Change the identification number of a drive connected to the panel link.
- View the status of the drives connected on the panel link.

The panel enters the Drive Selection Mode when the user presses the **DRIVE** key.

Each on-line station must have an individual identification number (ID). By default, the ID number of the drive is 1.

Note: The default ID number setting of the drive should not be changed unless the drive is to be connected to the panel link with other drives on-line.

How to select a drive and change its panel link ID number

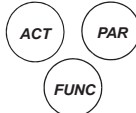
Step	Action	Press key	Display
1.	To enter the Drive Selection Mode.		ACS800 ASAAA5000 xxxxxxx ID NUMBER 1
2.	To select the next drive/view. The ID number of the station is changed by first pressing ENTER (the brackets round the ID number appear) and then adjusting the value with arrow buttons. The new value is accepted with ENTER . The power of the drive must be switched off to validate its new ID number setting. The status display of all devices connected to the Panel Link is shown after the last individual station. If all stations do not fit on the display at once, press the double-arrow up to view the rest of them.		ACS800 ASAAA5000 xxxxxxx ID NUMBER 1 1 ⤴ Status Display Symbols: ⤴ = Drive stopped, direction forward ⤵ = Drive running, direction reverse F = Drive tripped on a fault
3.	To connect to the last displayed drive and to enter another mode, press one of the mode selection keys. The selected mode is entered.		1 L -> 1242.0 rpm I FREQ 45.00 Hz CURRENT 80.00 A POWER 75.00 %

Reading and entering packed boolean values on the display

Some actual values and parameters are packed boolean, i.e. each individual bit has a defined meaning (explained at the corresponding signal or parameter). On the control panel, packed boolean values are read and entered in hexadecimal format.

In this example, bits 1, 3 and 4 of the packed boolean value are ON:

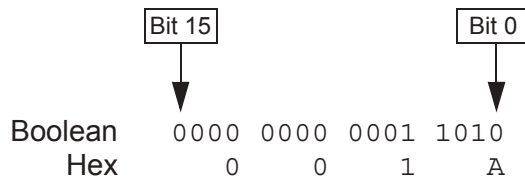

Program features

Chapter overview

The chapter describes program features. For each feature, there is a list of related user settings, actual signals, and fault and warning messages.

Start-up Assistant

Introduction

The assistant guides the user through the start-up procedure, helping the user to feed the requested data (parameter values) to the drive. The assistant also check that the entered values are valid, i.e. within the allowed range. At the first start, the drive suggests entering the first task of the assistant, Language Select, automatically.

The Start-up Assistant is divided into tasks. The user may activate the tasks either one after the other as the Start-up Assistant suggests, or independently. The user may also adjust the drive parameters in the conventional way without using the assistant at all.

See chapter [Control panel](#) on how to start the assistant, browse and exit.

Note: Option modules assistant is not supported from firmware version AS7R7363 onwards.

The default order of the tasks

Depending on the selection made in the Application task (parameter 99.02), the Start-up Assistant decide which consequent tasks it suggests. The default tasks are shown in the table below.

Application Selection	Default Tasks
FACTORY, SEQ CTRL	Language Select, Motor Set-up, Application, Option Modules, Speed Control EXT1, Start/Stop Control, Protections, Output Signals
HAND/AUTO	Language Select, Motor Set-up, Application, Option Modules, Speed Control EXT2, Start/Stop Control, Speed Control 1, Protections, Output Signals
T CTRL	Language Select, Motor Set-up, Application, Option Modules, Torque Control, Start/Stop Control, Speed Control EXT1, Protections, Output Signals
PID CTRL	Language Select, Motor Set-up, Application, Option Modules, PID Control, Start/Stop Control, Speed Control EXT1, Protections, Output Signals

List of tasks and the relevant drive parameters

Name	Description	Set parameters
Language Select	Selecting the language	99.01
Motor Set-up	Setting the motor data Performing the motor identification. (If the speed limits are not in the allowed range: Setting the limits).	99.05, 99.06, 99.09, 99.07, 99.08, 99.04 99.10 (20.8, 20.07)
Application	Selecting the application macro	99.02, parameters associated to the macro
Option Modules	Activating the option modules	Group 98, 35, 52
Speed Control EXT1	Selecting the source for the speed reference (If AI1 is used: Setting analogue input AI1 limits, scale, inversion) Setting the reference limits Setting the speed (frequency) limits Setting acceleration and deceleration times (Setting up the brake chopper if activated by parameter 27.01) (If 99.02 is not SEQ CTRL: Setting constant speeds)	11.03 (13.01, 13.02, 13.03, 13.04, 13.05, 30.01) 11.04, 11.05 20.02, 20.01, (20.08, 20.07) 22.02, 22.03 (Group 27, 20.05, 14.01) (Group 12)
Speed Control EXT2	Selecting the source for the speed reference (If AI1 is used: Setting analogue input AI1 limits, scale, inversion) Setting the reference limits	11.06 (13.01, 13.02, 13.03, 13.04, 13.05, 30.01) 11.08, 11.07
Torque Control	Selecting the source for the torque reference (If AI1 is used: Setting analogue input AI1 limits, scale, inversion) Setting the reference limits Setting the torque ramp up and ramp down times	11.06 (13.01, 13.02, 13.03, 13.04, 13.05, 30.01) 11.08, 11.07 24.01, 24.02
PID Control	Selecting the source for the process reference (If AI1 is used: Setting analogue input AI1 limits, scale, inversion) Setting the reference limits Setting the speed (reference) limits Setting the source and limits for the process actual value	11.06 (13.01, 13.02, 13.03, 13.04, 13.05, 30.01) 11.08, 11.07 20.02, 20.01 (20.08, 20.07) 40.07, 40.09, 40.10
Start/Stop Control	Selecting the source for start and stop signals of the two external control locations, EXT1 and EXT2 Selecting between EXT1 and EXT2 Defining the direction control Defining the start and stop modes Selecting the use of Run Enable signal Setting the ramp time for the Run Enable function	10.01, 10.02 11.02 10.03 21.01, 21.02, 21.03 16.01, 21.07 22.07
Protections	Setting the torque and current limits	20.03, 20.04
Output Signals	Selecting the signals indicated through the relay outputs RO1, RO2, RO3 and optional RO's (if installed) Selecting the signals indicated through the analogue output AO1, AO2 and optional AO's (if installed). Setting the minimum, maximum, scaling and inversion.	Group 14 15.01, 15.02, 15.03, 15.04, 15.05, (Group 96)

Contents of the assistant displays

There are two types of displays in the Start-up Assistant: The main displays and the information displays. The main displays prompt the user to feed in information or answer a question. The assistant steps through the main displays. The information displays contain help texts for the main displays. The figure below shows a typical example of both and explanations of the contents.

Main Display		Information Display
1	Motor Setup 3/10	INFO P99.05
2	MOTOR NOM VOLTAGE?	Set as given on the motor nameplate.
3	[0 V]	
4	ENTER:Ok RESET:Back	▲▲
↓		
1	Name of the assistant, step number / total number of steps	Text INFO, index of parameter to be set
2	Request/question	Help text ...
3	Feed-in field	... help text continued
4	Commands: accept value and step forward or cancel and step backwards	double arrow symbol (indicates that the text continues)

Local control vs. external control

The drive can receive start, stop and direction commands and reference values from the control panel or through digital and analogue inputs. An optional fieldbus adapter enables control over an open fieldbus link. A PC equipped with DriveWindow can also control the drive.

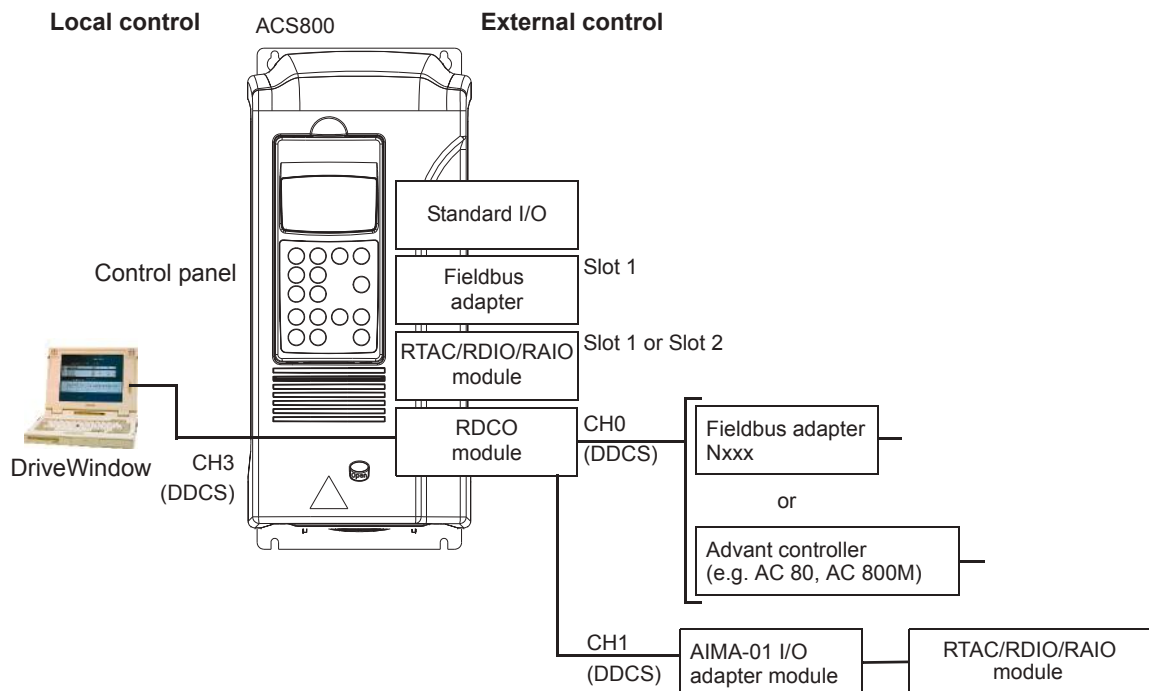

Local control

The control commands are given from the control panel keypad when the drive is in local control. L indicates local control on the panel display.

1 (L) -> 1242 rpm I

The control panel always overrides the external control signal sources when used in local mode.

External control

When the drive is in external control, the commands are given through the standard I/O terminals (digital and analogue inputs), optional I/O extension modules and/or the fieldbus interface. In addition, it is also possible to set the control panel as the source for the external control.

External control is indicated by a blank on the panel display or with an R in those special cases when the panel is defined as a source for external control.

1 () -> 1242 rpm I

External Control through the Input/
Output terminals, or through the
fieldbus interfaces

1 (R) -> 1242 rpm I

External Control by control panel

The user can connect the control signals to two external control locations, EXT1 or EXT2. Depending on the user selection, either one is active at a time. This function operates on a 12 ms time level.

Settings

Panel key	Additional information
LOC/REM	Selection between local and external control
Parameter	
11.02	Selection between EXT1 and EXT2
10.01	Start, stop, direction source for EXT1
11.03	Reference source for EXT1
10.02	Start, stop, direction source for EXT2
11.06	Reference source for EXT2
Group 98 OPTION MODULES	Activation of the optional I/O and serial communication

Diagnostics

Actual signals	Additional information
01.11, 01.12	EXT1 reference, EXT2 reference
03.02	EXT1/EXT2 selection bit in a packed boolean word

Block diagram: start, stop, direction source for EXT1

The figure below shows the parameters that select the interface for start, stop, and direction for external control location EXT1.

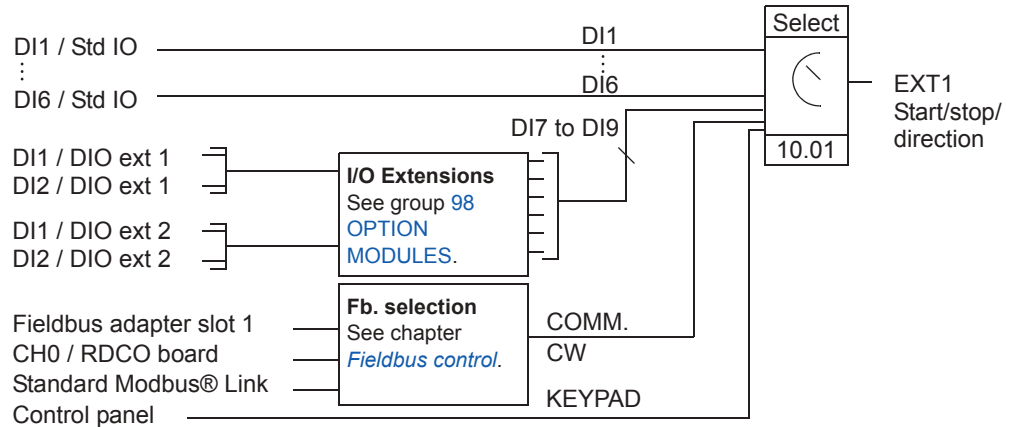

DI1 / Std IO = Digital input DI1 on the standard I/O terminal block

DI1 / DIO ext 1 = Digital input DI1 on the digital I/O extension module 1

Block diagram: reference source for EXT1

The figure below shows the parameters that select the interface for the speed reference of external control location EXT1.

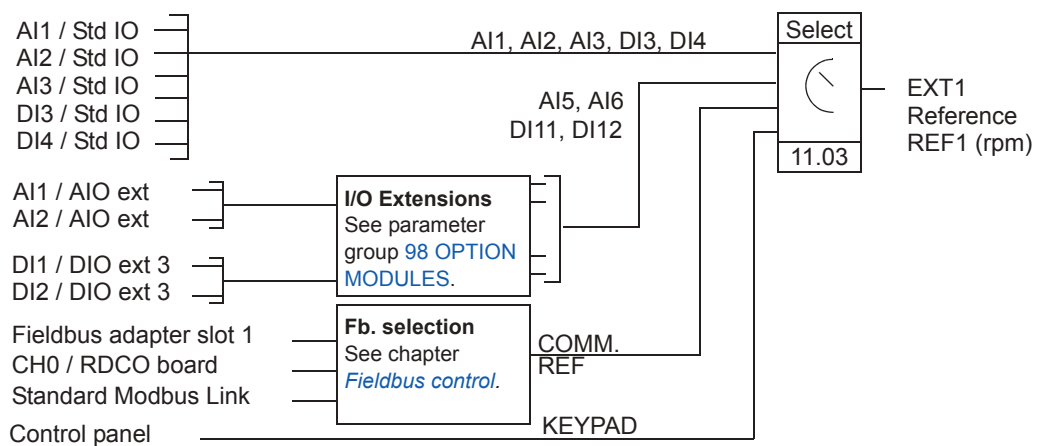

AI1 / Std IO = Analogue input AI1 on the standard I/O terminal block

AI1 / AIO ext = Analogue input AI1 on the analogue I/O extension module

Reference types and processing

The drive can accept a variety of references in addition to the conventional analogue input signal and control panel signals.

- The drive reference can be given with two digital inputs: One digital input increases the speed, the other decreases it.
- The drive accepts a bipolar analogue speed reference. This feature allows both the speed and direction to be controlled with a single analogue input. The minimum signal is full speed reversed and the maximum signal is full speed forward.
- The drive can form a reference out of two analogue input signals by using mathematical functions: Addition, subtraction, multiplication, minimum selection, and maximum selection.
- The drive can form a reference out of an analogue input signal and a signal received through a serial communication interface by using mathematical functions: addition and multiplication.

It is possible to scale the external reference so that the signal minimum and maximum values correspond to a speed other than the minimum and maximum speed limits.

Settings

Parameter	Additional information
Group 11 REFERENCE SELECT	External reference source, type and scaling
Group 20 LIMITS	Operating limits
Group 22 ACCEL/DECEL	Speed reference acceleration and deceleration ramps
Group 24 TORQUE CTRL	Torque reference ramp times
Group 32 SUPERVISION	Reference supervision

Diagnostics

Actual signal	Additional information
01.11, 01.12	Values of external references
Group 02 ACTUAL SIGNALS	The reference values in different stages of the reference processing chain.
Parameter	
Group 14 RELAY OUTPUTS	Active reference / reference loss through a relay output
Group 15 ANALOGUE OUTPUTS	Reference value

Reference trimming

In reference trimming, the external %-reference (External reference REF2) is corrected depending on the measured value of a secondary application variable. The block diagram below illustrates the function.

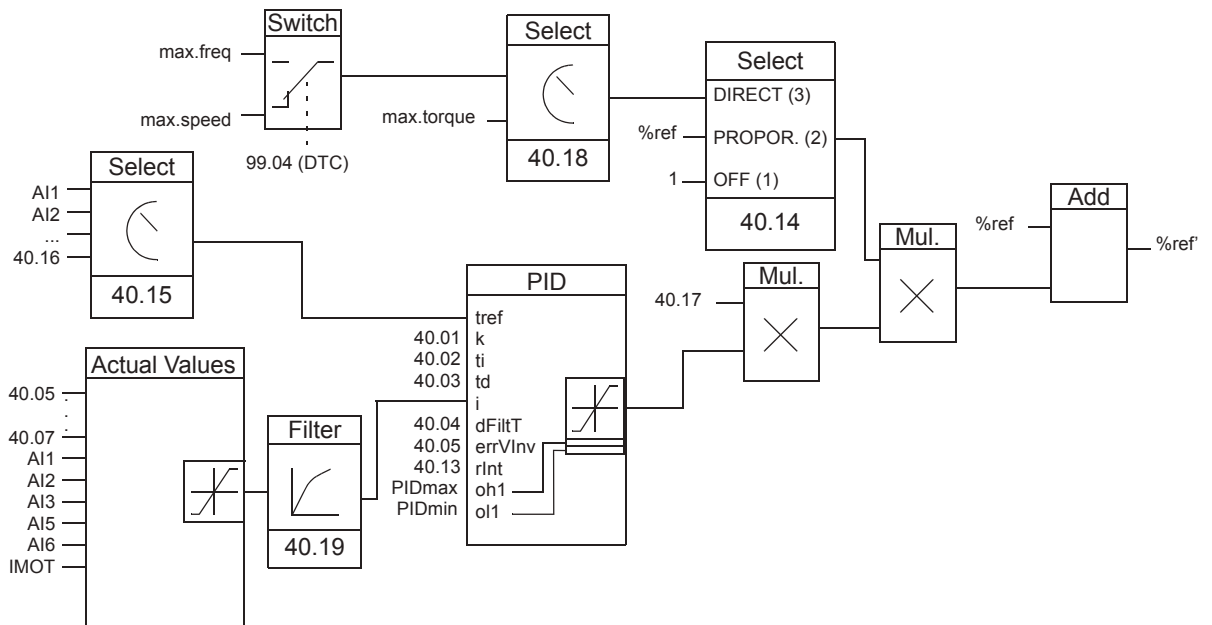

%ref= The drive reference before trimming
 %ref' = The drive reference after trimming
 max. speed= Par. 20.02 (or 20.01 if the absolute value is greater)
 max. freq = Par. 20.08 (or 20.07 if the absolute value is greater)
 max. torq = Par. 20.14 (or 20.13 if the absolute value is greater)

Settings

Parameter	Additional information
40.14...40.18	Trimming function settings
40.01...40.13, 40.19	PID control block settings
Group 20 LIMITS	Drive operation limits

Example

The drive runs a conveyor line. It is speed-controlled but the line tension also needs to be taken into account: If the measured tension exceeds the tension setpoint, the speed will be slightly decreased, and vice versa.

To accomplish the desired speed correction, the user:

- activates the trimming function and connects the tension setpoint and the measured tension to it
- tunes the trimming to a suitable level.

Speed controlled conveyor line

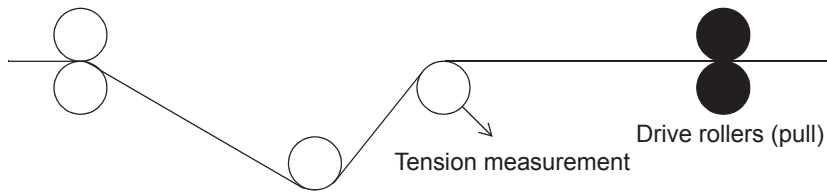

Simplified block diagram

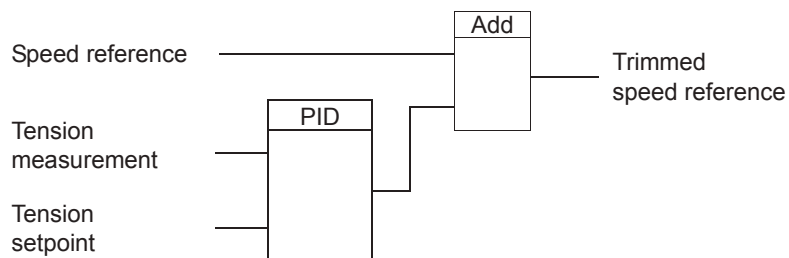

Programmable analogue inputs

The drive has three programmable analogue inputs: one voltage input (0/2 to 10 V or -10 to 10 V) and two current inputs (0/4 to 20 mA). Two extra inputs are available if an optional analogue I/O extension module is used. Each input can be inverted and filtered, and the maximum and minimum values can be adjusted.

Update cycles in the Standard Control Program

Input	Cycle
AI / standard	6 ms
AI / extension	6 ms (100 ms ¹⁾)

¹⁾ Update cycle in the motor temperature measurement function. See group [35 MOT TEMP MEAS](#).

Settings

Parameter	Additional information
Group 11 REFERENCE SELECT	AI as a reference source
Group 13 ANALOGUE INPUTS	Processing of the standard inputs
30.01	Supervision of AI loss
Group 40 PID CONTROL	AI as a PID process control reference or actual values
35.01	AI in a motor temperature measurement
40.15	AI in a drive reference trimming
42.07	AI in a mechanical brake control function
98.06	Activation of optional analogue inputs
98.13	Optional AI signal type definition (bipolar or unipolar)
98.14	Optional AI signal type definition (bipolar or unipolar)

Diagnostics

Actual value	Additional information
01.18 , 01.19 , 01.20	Values of standard inputs
01.38 , 01.39	Value of optional inputs
Group 09 ACTUAL SIGNALS	Scaled analogue input values (integer values for function block programming)

Programmable analogue outputs

Two programmable current outputs (0/4 to 20 mA) are available as standard, and two outputs can be added by using an optional analogue I/O extension module. Analogue output signals can be inverted and filtered.

The analogue output signals can be proportional to motor speed, process speed (scaled motor speed), output frequency, output current, motor torque, motor power, etc.

It is possible to write a value to an analogue output through a serial communication link.

Update cycles in the Standard Control Program

Output	Cycle
AO / standard	24 ms
AO / extension	24 ms (1000 ms ¹⁾)

¹⁾ Update cycle in the motor temperature measurement function. See group [35 MOT TEMP MEAS](#).

Settings

Parameter	Additional information
Group 15 ANALOGUE OUTPUTS	AO value selection and processing (standard outputs)
30.20	Operation of an externally controlled AO in a communication break
30.22	Supervision of the use of optional AO
Group 35 MOT TEMP MEAS	AO in motor temperature measurement
Group 96 EXTERNAL AO	Optional AO value selection and processing
Group 98 OPTION MODULES	Activation of optional I/O

Diagnostics

Actual value	Additional information
01.22 , 01.23	Values of the standard outputs
01.28 , 01.29	Values of the optional outputs
Warning	
IO CONFIG (FF8B)	Improper use of optional I/O

Programmable digital inputs

The drive has six programmable digital inputs as a standard. Six extra inputs are available if optional digital I/O extension modules are used.

Update cycles in the Standard Control Program

Input	Cycle
DI / standard	6 ms
DI / extension	12 ms

Settings

Parameter	Additional information
Group 10 START/STOP/DIR	DI as start, stop, direction
Group 11 REFERENCE SELECT	DI in reference selection, or reference source
Group 12 CONSTANT SPEEDS	DI in constant speed selection
Group 16 SYST CTRL INPUTS	DI as external Run Enable, fault reset or user macro change signal
22.01	DI as acceleration and deceleration ramp selection signal
30.03	DI as external fault source
30.05	DI in motor overtemperature supervision function
30.22	Supervision of optional I/O use
40.20	DI as sleep function activation signal (in PID process control)
42.02	DI as mechanical brake acknowledgement signal
98.03...96.05	Activation of the optional digital I/O extension modules
98.09...98.11	Naming of the optional digital inputs in the application program

Diagnostics

Actual value	Additional information
01.17	Values of the standard digital inputs
01.40	Values of the optional digital inputs
Warning	
IO CONFIG (FF8B)	Improper use of optional I/O
Fault	
I/O COMM ERR (7000)	Communication loss to I/O

Programmable relay outputs

As standard there are three programmable relay outputs. Six outputs can be added by using the optional digital I/O extension modules. By means of a parameter setting it is possible to choose which information to indicate through the relay output: ready, running, fault, warning, motor stall, etc.

It is possible to write a value to a relay output through a serial communication link.

Update cycles in the Standard Control Program

Output	Cycle
RO / standard	100 ms
RO / extension	100 ms

Settings

Parameter	Additional information
Group 14 RELAY OUTPUTS	RO value selections and operation times
30.20	Operation of an externally controlled relay output on a communication break
Group 42 BRAKE CONTROL	RO in a mechanical brake control
Group 98 OPTION MODULES	Activation of optional relay outputs

Diagnostics

Actual value	Additional information
01.21	Standard relay output states
01.41	Optional relays output states

Actual signals

Several actual signals are available:

- Drive output frequency, current, voltage and power
- Motor speed and torque
- Supply voltage and intermediate circuit DC voltage
- Active control location (Local, EXT1 or EXT2)
- Reference values
- Drive temperature
- Operating time counter (h), kWh counter
- Digital I/O and Analogue I/O status
- PID controller actual values (if the PID Control macro is selected)

Three signals can be shown simultaneously on the control panel display. It is also possible to read the values through the serial communication link or through the analogue outputs.

Settings

Parameter	Additional information
Group 15 ANALOGUE OUTPUTS	Selection of an actual signal to an analogue output
Group 92 D SET TR ADDR	Selection of an actual signal to a data set (serial communication)

Diagnostics

Actual value	Additional information
Group 01 ACTUAL SIGNALS ... 09 ACTUAL SIGNALS	Lists of actual signals

Motor identification

The performance of Direct Torque Control is based on an accurate motor model determined during the motor start-up.

A motor Identification Magnetisation is automatically done the first time the start command is given. During this first start-up, the motor is magnetised at zero speed for several seconds to allow the motor model to be created. This identification method is suitable for most applications.

In demanding applications a separate Identification Run can be performed.

Settings

Parameter [99.10](#).

Power loss ride-through

If the incoming supply voltage is cut off, the drive will continue to operate by utilising the kinetic energy of the rotating motor. The drive will be fully operational as long as the motor rotates and generates energy to the drive. The drive can continue the operation after the break if the main contactor remained closed.

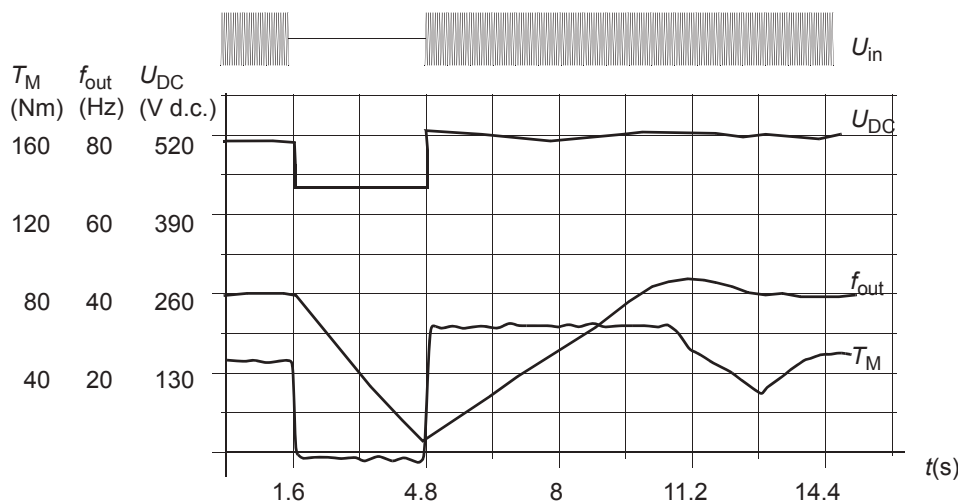

U_{DC} = Intermediate circuit voltage of the drive, f_{out} = output frequency of the drive, T_M = Motor torque

Loss of supply voltage at nominal load ($f_{out} = 40$ Hz). The intermediate circuit DC voltage drops to the minimum limit. The controller keeps the voltage steady as long as the supply voltage is switched off. The drive runs the motor in generator mode. The motor speed falls but the drive is operational as long as the motor has enough kinetic energy.

Note: Cabinet assembled units equipped with main contactor option have a “hold circuit” that keeps the contactor control circuit closed during a short supply break. The allowed duration of the break is adjustable. The factory setting is five seconds.

Automatic Start

Since the drive can detect the state of the motor within a few milliseconds, the starting is immediate under all conditions. There is no restart delay. E.g. the starting of turbining pumps or windmilling fans is easy.

Settings

Parameter [21.01](#).

Safe torque off (STO)

Safe torque off function disconnects the control voltage from the inverter power semiconductors, i.e. the drive output voltage is cut off. See the circuit diagrams delivered with the drive for the wirings to be made by the user.



WARNING! The Safe torque off function does not disconnect the voltage of the main and auxiliary circuits from the drive. Therefore, maintenance work on electrical parts may only be carried out after disconnecting the drive system from the input power line.

The Safe torque off function operates as follows:

- The operator gives an STO function activation command (for example, with a switch mounted on the control desk).
- The voltage supply of the ASTO-x1C board is disconnected.
- The drive application program receives an internal signal from the AINT board that an STO function activation command has been given. If the STO function activation command was given during run, the drive coasts to stop.
- The Safe torque off function is activated.
- Alarm START INHIBI is activated (03.08 Alarm Word 1 bit 0 value is 1).
- 03.03 AUX STATUS WORD bit 8 value is set to 1 (= Safe torque off function is active) within 3 seconds.

Note: Fault START INHIBI is generated (03.03 AUX STATUS WORD bit 8 value is 1) if the Safe torque off function is activated during motor run or if motor start command is given when the Safe torque off function is already active.

Diagnostics

Actual value	Additional information
03.03 AUX STATUS WORD, bit 8	Safe torque off function activation status
03.08 ALARM WORD 1, bit 0 / 03.03 AUX STATUS WORD, bit 8	Safe torque off function alarm/fault

Prevention of unexpected start-up (POUS)

The Prevention of unexpected start-up functions as Safe torque off described above, with the following exceptions:

- POUS must not be activated during run.
- POUS requires an AGPS-x1C board (not ASTO-x1C).

Safely-limited speed (SLS) (AS7R firmware version only)

The SLS function limits the motor speed to a safe value.

Note: If used without a safety PLC, the SLS function does not fulfill the requirements for SIL classification as defined in EN IEC 61800-5-2.

When the SLS function is activated, speed limits are ramped from the values of 20.01 MINIMUM SPEED and 20.02 MAXIMUM SPEED to the value of 20.22 SLS SPEED LIMIT and its additive inverse, respectively. The ramping begins at the absolute value of the actual speed. If the actual speed is already below the SLS limit, the limit comes into effect immediately without ramping.

When the SLS function is deactivated, the speed limits are ramped up back to the values defined by 20.01 and 20.02, and the actual speed returns to the reference value if it was limited by this function.

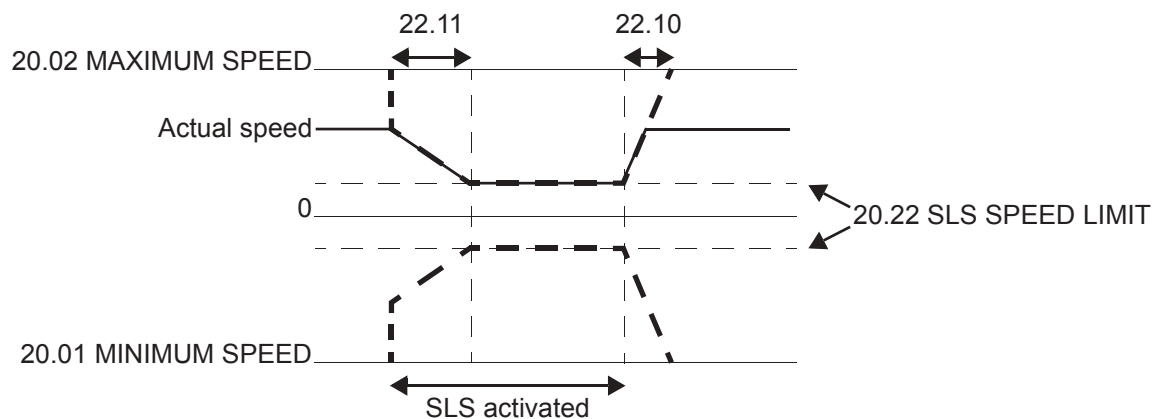

Settings

Parameter	Additional information
10.09 SLS ACTIVE	Selection of DI source
20.22 SLS SPEED LIMIT	Safely-limited speed limit
22.10 SLS ACCELER TIME	Time required for speed limit to ramp up from SLS to normal
22.11 SLS DECELER TIME	Time required for speed limit to ramp down from current actual speed to SLS

Diagnostics and control

Actual value	Additional information
03.04 FREQ_LIMIT, bit 15	SLS activation status

See also *Safe speed functions for ACS800 cabinet-installed drives (+Q965/+Q966) Application guide* [3AUA0000090742 (English)].

Note: When SLS function is active, critical speed settings in parameter group 25 are not in effect.

DC Magnetising

When DC Magnetising is activated, the drive automatically magnetises the motor before starting. This feature guarantees the highest possible breakaway torque, up to 200% of motor nominal torque. By adjusting the premagnetising time, it is possible to synchronise the motor start and e.g. a mechanical brake release. The Automatic Start feature and DC Magnetising cannot be activated at the same time.

Settings

Parameters [21.01](#) and [21.02](#).

DC Hold

By activating the motor DC Hold feature it is possible to lock the rotor at zero speed. When both the reference and the motor speed fall below the preset DC hold speed, the drive stops the motor and starts to inject DC into the motor. When the reference speed again exceeds the DC hold speed, the normal drive operation resumes.

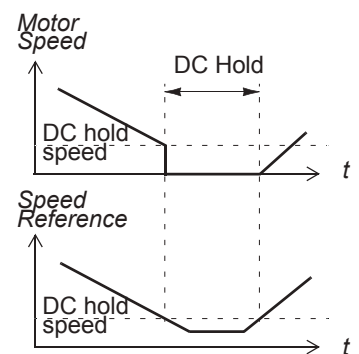

Settings

Parameters [21.04](#), [21.05](#), and [21.06](#).

Flux Braking

The drive can provide greater deceleration by raising the level of magnetisation in the motor. By increasing the motor flux, the energy generated by the motor during braking can be converted to motor thermal energy. This feature is useful in motor power ranges below 15 kW.

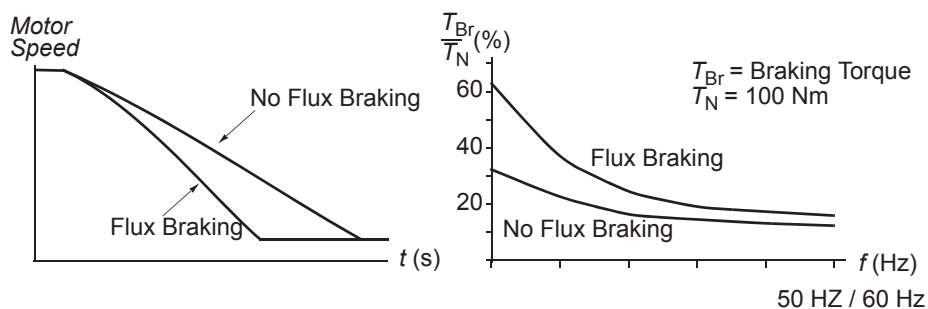

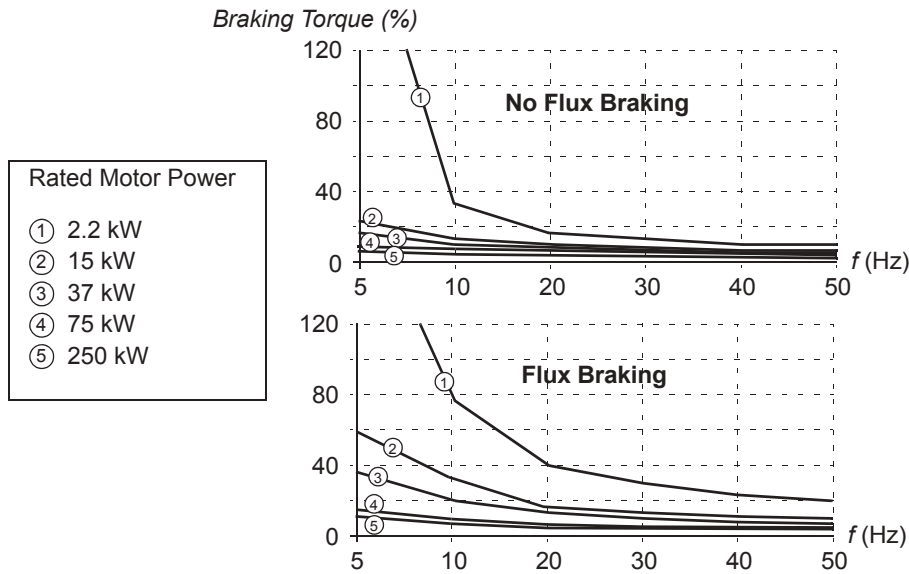

The drive monitors the motor status continuously, also during the Flux Braking. Therefore, Flux Braking can be used both for stopping the motor and for changing the speed. The other benefits of Flux Braking are:

- The braking starts immediately after a stop command is given. The function does not need to wait for the flux reduction before it can start the braking.
- The cooling of the motor is efficient. The stator current of the motor increases during the Flux Braking, not the rotor current. The stator cools much more efficiently than the rotor.

Settings

Parameter [26.02](#).

Flux Optimisation

Flux Optimisation reduces the total energy consumption and motor noise level when the drive operates below the nominal load. The total efficiency (motor and the drive) can be improved by 1% to 10%, depending on the load torque and speed.

Settings

Parameter [26.01](#).

Acceleration and deceleration ramps

Two user-selectable acceleration and deceleration ramps are available. It is possible to adjust the acceleration/deceleration times and the ramp shape. Switching between the two ramps can be controlled via a digital input.

The available ramp shape alternatives are Linear and S-curve.

Linear: Suitable for drives requiring steady or slow acceleration/deceleration.

S-curve: Ideal for conveyors carrying fragile loads, or other applications where a smooth transition is required when changing the speed.

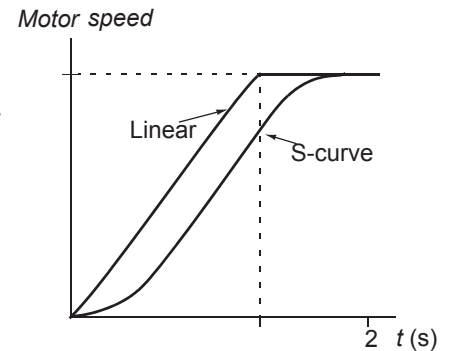

Settings

Parameter group [22 ACCEL/DECEL](#).

Critical speeds

A Critical Speeds function is available for applications where it is necessary to avoid certain motor speeds or speed bands because of e.g. mechanical resonance problems.

Settings

Parameter group [25 CRITICAL SPEEDS](#).

Constant speeds

It is possible to predefine 15 constant speeds. Constant speeds are selected with digital inputs. Constant speed activation overrides the external speed reference.

This function operates on a 6 ms time level.

Settings

Parameter group [12 CONSTANT SPEEDS](#).

Speed controller tuning

During the motor identification, the speed controller is automatically tuned. It is, however, possible to manually adjust the controller gain, integration time and derivation time, or let the drive perform a separate speed controller Autotune Run. In Autotune Run, the speed controller is tuned based on the load and inertia of the motor and the machine. The figure below shows speed responses at a speed reference step (typically, 1 to 20%).

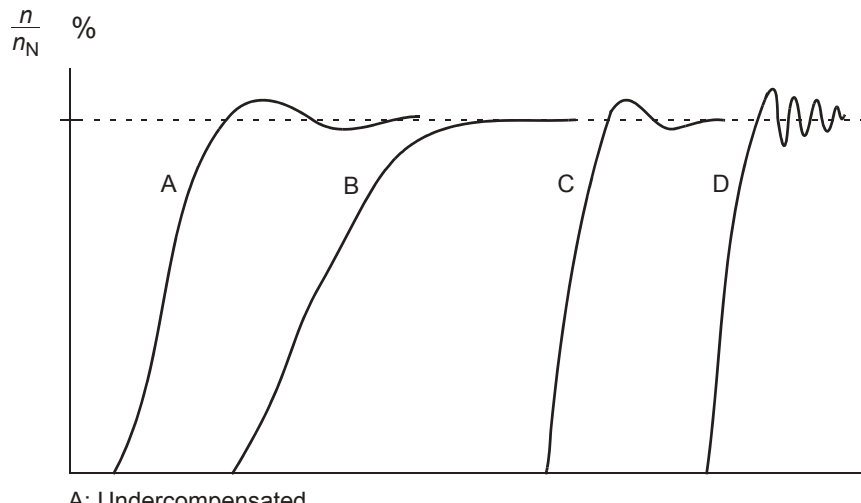

- A: Undercompensated
- B: Normally tuned (autotuning)
- C: Normally tuned (manually). Better dynamic performance than with B
- D: Overcompensated speed controller

The figure below is a simplified block diagram of the speed controller. The controller output is the reference for the torque controller.

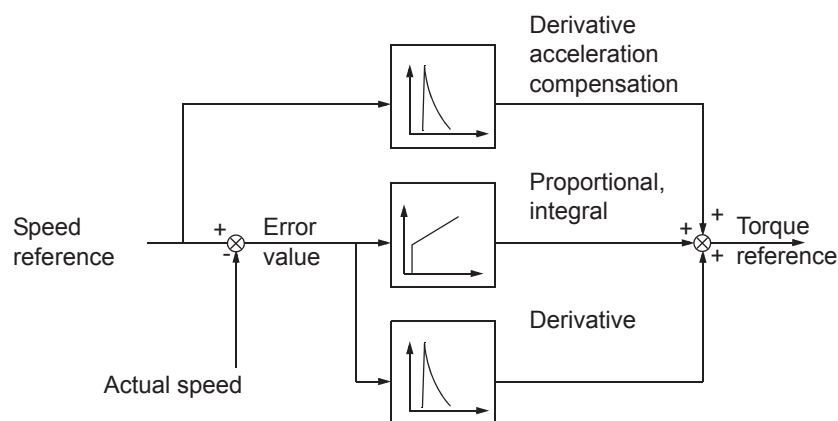

Settings

Parameter group [23 SPEED CTRL](#) and [20 LIMITS](#).

Diagnostics

Actual signal [01.02](#).

Speed control performance figures

The table below shows typical performance figures for speed control when Direct Torque Control is used.

Speed Control	No Pulse Encoder	With Pulse Encoder
Static speed error, % of n_N	± 0.1 to 0.5% (10% of nominal slip)	$\pm 0.01\%$
Dynamic speed error	0.4 %sec.^*	0.1 %sec.^*

*Dynamic speed error depends on speed controller tuning.

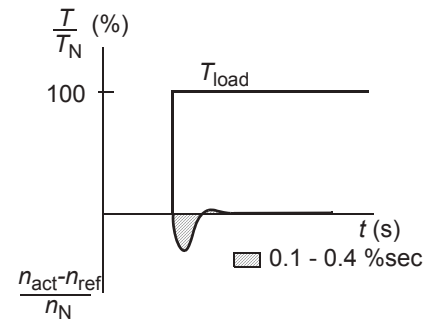

T_N = rated motor torque
 n_N = rated motor speed
 n_{act} = actual speed
 n_{ref} = speed reference

Torque control performance figures

The drive can perform precise torque control without any speed feedback from the motor shaft. The table below shows typical performance figures for torque control, when Direct Torque Control is used.

Torque Control	No Pulse Encoder	With Pulse Encoder
Linearity error	$\pm 4\%^*$	$\pm 3\%$
Repeatability error	$\pm 3\%^*$	$\pm 1\%$
Torque rise time	1 to 5 ms	1 to 5 ms

*When operated around zero frequency, the error may be greater.

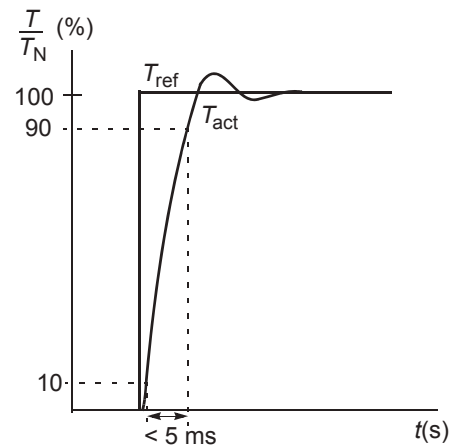

T_N = rated motor torque
 T_{ref} = torque reference
 T_{act} = actual torque

Scalar control

It is possible to select Scalar Control as the motor control method instead of Direct Torque Control (DTC). In the Scalar Control mode, the drive is controlled with a frequency reference. The outstanding performance of the default motor control method, Direct Torque Control, is not achieved in Scalar Control.

It is recommended to activate the Scalar Control mode in the following special applications:

- In multimotor drives: 1) if the load is not equally shared between the motors, 2) if the motors are of different sizes, or 3) if the motors are going to be changed after the motor identification
- If the nominal current of the motor is less than 1/6 of the nominal output current of the drive
- If the drive is used without a motor connected (e.g. for test purposes)
- The drive runs a medium voltage motor via a step-up transformer.

In the Scalar Control mode, some standard features are not available.

Settings

Parameter [99.04](#).

IR compensation for a scalar controlled drive

IR Compensation is active only when the motor control mode is Scalar (see section [Scalar control](#) on page [62](#)). When IR Compensation is activated, the drive gives an extra voltage boost to the motor at low speeds. IR Compensation is useful in applications that require high breakaway torque. In Direct Torque Control, no IR Compensation is possible/needed.

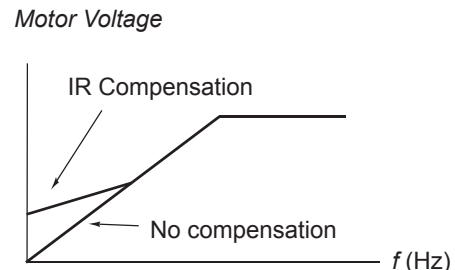

Settings

Parameter [26.03](#).

Hexagonal motor flux

Typically the drive controls the motor flux in such a way that the rotating flux vector follows a circular pattern. This is ideal in most applications. When operated above the field weakening point (FWP, typically 50 or 60 Hz), it is, however, not possible to reach 100% of the output voltage. The peak load capacity of the drive is lower than with the full voltage.

If hexagonal flux control is selected, the motor flux is controlled along a circular pattern below the field weakening point, and along a hexagonal pattern in the field weakening range. The applied pattern is changed gradually as the frequency increases from 100% to 120% of the FWP. Using the hexagonal flux pattern, the maximum output voltage can be reached; The peak load capacity is higher than with the circular flux pattern but the continuous load capacity is lower in the frequency range of FWP to $1.6 \cdot \text{FWP}$, due to increased losses.

Settings

Parameter [26.05](#).

Programmable protection functions

AI<Min

AI<Min function defines the drive operation if an analogue input signal falls below the preset minimum limit.

Settings

Parameter [30.01](#).

Panel Loss

Panel Loss function defines the operation of the drive if the control panel selected as control location for the drive stops communicating.

Settings

Parameter [30.02](#).

External Fault

External Faults can be supervised by defining one digital input as a source for an external fault indication signal.

Settings

Parameter [30.03](#).

Motor Thermal Protection

The motor can be protected against overheating by activating the Motor Thermal Protection function and by selecting one of the motor thermal protection modes available.

The Motor Thermal Protection modes are based either on a motor temperature thermal model or on an overtemperature indication from a motor thermistor.

Motor temperature thermal model

The drive calculates the temperature of the motor on the basis of the following assumptions:

- 1) The motor is at the estimated temperature (value of [01.37](#) MOTOR TEMP EST saved at power switch off) when power is applied to the drive. When power is applied for the first time, the motor is at the ambient temperature (30°C).
- 2) Motor temperature is calculated using either the user-adjustable or automatically calculated motor thermal time and motor load curve (see the figures below). The load curve should be adjusted in case the ambient temperature exceeds 30°C.

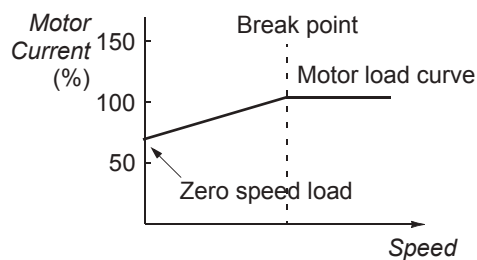
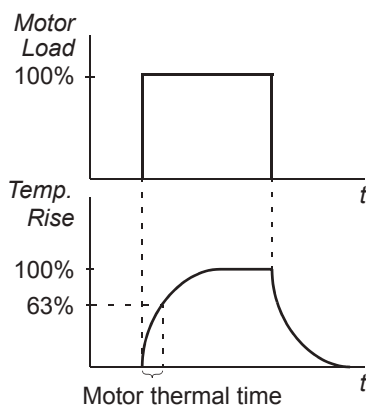

Use of the motor thermistor

It is possible to detect motor overtemperature by connecting a motor thermistor (PTC) between the +24 VDC voltage supply offered by the drive and digital input DI6. In normal motor operation temperature, the thermistor resistance should be less than 1.5 kohm (current 5 mA). The drive stops the motor and gives a fault indication if the thermistor resistance exceeds 4 kohm. The installation must meet the regulations for protecting against contact.

Settings

Parameters [30.04](#) to [30.09](#).

Note: It is also possible to use the motor temperature measurement function. See sections [Motor temperature measurement through the standard I/O](#) on page [73](#) and [Motor temperature measurement through an analogue I/O extension](#) on page [75](#).

Stall Protection

The drive protects the motor in a stall situation. It is possible to adjust the supervision limits (torque, frequency, time) and choose how the drive reacts to a motor stall condition (warning indication / fault indication & stop the drive / no reaction).

The torque and current limits, which define the stall limit, must be set according to the maximum load of the used application. **Note:** Stall limit is restricted by internal current limit [03.04](#) TORQ_INV_CUR_LIM.

When the application reaches the stall limit and the output frequency of the drive is below the stall frequency: Fault is activated after the stall time delay.

Settings

Parameters [30.10](#) to [30.12](#).

Parameters [20.03](#), [20.13](#) and [20.14](#) (Define the stall limit.)

Underload Protection

Loss of motor load may indicate a process malfunction. The drive provides an underload function to protect the machinery and process in such a serious fault condition. Supervision limits - underload curve and underload time - can be chosen as well as the action taken by the drive upon the underload condition (warning indication / fault indication & stop the drive / no reaction).

Settings

Parameters [30.13](#) to [30.15](#).

Motor Phase Loss

The Phase Loss function monitors the status of the motor cable connection. The function is useful especially during the motor start: the drive detects if any of the motor phases is not connected and refuses to start. The Phase Loss function also supervises the motor connection status during normal operation.

Settings

Parameter [30.16](#).

Earth Fault Protection

The earth fault protection detects earth faults in the motor or motor cable. The protection is based on sum current measurement.

- An earth fault in the supply cable does not activate the protection.
- In an earthed (grounded) supply, the protection activates in 200 microseconds.
- In an unearthed (ungrounded) supply, the supply capacitance should be 1 microfarad or more.
- The capacitive currents caused by shielded motor cables up to 300 metres do not activate the protection.
- Earth fault protection is deactivated when the drive is stopped.

Note: With parallel connected inverter modules, the earth fault indication is CUR UNBAL xx. See chapter *Fault tracing*.

Settings

Parameter [30.17](#).

Communication Fault

The Communication Fault function supervises the communication between the drive and an external control device (e.g. a fieldbus adapter module).

Settings

Parameters [30.18](#) to [30.21](#).

Supervision of optional IO

The function supervises the use of the optional analogue and digital inputs and outputs in the application program, and warns if the communication to the input/output is not operational.

Settings

Parameter [30.22](#).

Preprogrammed faults

Overcurrent

The overcurrent trip limit for the drive is 1.65 to $2.17 \cdot I_{\max}$ depending on the drive type.

DC overvoltage

The DC overvoltage trip limit is $1.3 \times 1.35 \times U_{1\max}$, where $U_{1\max}$ is the maximum value of the supply voltage range. For 400 V units, $U_{1\max}$ is 415 V. For 500 V units, $U_{1\max}$ is 500 V. For 690 V units, $U_{1\max}$ is 690 V. The actual voltage in the intermediate circuit corresponding to the supply voltage trip level is 728 V DC for 400 V units, 877 V DC for 500 V units, and 1210 V DC for 690 V units.

DC undervoltage

The DC undervoltage trip limit is $0.6 \times 1.35 \times U_{1\min}$, where $U_{1\min}$ is the minimum value of the supply voltage range. For 400 V and 500 V units, $U_{1\min}$ is 380 V. For 690 V units, $U_{1\min}$ is 525 V. The actual voltage in the intermediate circuit corresponding to the supply voltage trip level is 307 V DC for 400 V and 500 V units, and 425 V DC for 690 V units.

Drive temperature

The drive supervises the inverter module temperature. There are two supervision limits: warning limit and fault trip limit.

Enhanced drive temperature monitoring for ACS800, frame sizes R7 and R8

Traditionally, drive temperature monitoring is based on the power semiconductor (IGBT) temperature measurement which is compared with a fixed maximum IGBT temperature limit. However, certain abnormal conditions such as cooling fan failure, insufficient cooling air flow or excessive ambient temperature might cause overheating inside the converter module, which the traditional temperature monitoring alone does not detect. The Enhanced drive temperature monitoring improves the protection in these situations.

The function monitors the converter module temperature by checking cyclically that the measured IGBT temperature is not excessive considering the load current, ambient temperature, and other factors that affect the temperature rise inside the converter module. The calculation uses an experimentally defined equation that simulates the normal temperature changes in the module depending on the load. Drive generates a warning when the temperature exceeds the limit, and trips when temperature exceeds the limit by 5°C.

Note: The monitoring is available for ACS800-02, -04 and -07, frame sizes R7 and R8 with Standard Control Program version ASXR7360 (and later versions). For ACS800-U2, -U4 and -U7, frame sizes R7 and R8, the monitoring is available with Standard Control Program version ASXR730U (and later versions).

Types to which the enhanced drive temperature monitoring is available:

ACS800-XX -0080-2
 -0100-2
 -0120-2
 -0140-2/3/7
 -0170-2/3/5/7
 -0210-2/3/5/7
 -0230-2
 -0260-2/3/5/7
 -0270-5
 -0300-2/5
 -0320-3/5/7
 -0400-3/5/7

-0440-3/5/7

-0490-3/5/7

-0550-5/7

-0610-5/7

Settings

Parameter	Additional information
95.10 TEMP INV AMBIENT	Ambient temperature

Diagnostics

Warning/Fault	Additional information
INV OVERTEMP	Excessive converter module temperature

Short circuit

There are separate protection circuits for supervising the motor cable and the inverter short circuits. If a short circuit occurs, the drive will not start and a fault indication is given.

Input phase loss

Input phase loss protection circuits supervise the supply cable connection status by detecting intermediate circuit ripple. If a phase is lost, the ripple increases. The drive is stopped and a fault indication is given if the ripple exceeds 13%.

Control board temperature

The drive supervises the control board temperature. A fault indication CTRL B TEMP is given, if the temperature exceeds 88°C.

Overfrequency

If the drive output frequency exceeds the preset level, the drive is stopped and a fault indication is given. The preset level is 50 Hz over the operating range absolute maximum speed limit (Direct Torque Control mode active) or frequency limit (Scalar Control active).

Internal fault

If the drive detects an internal fault, the drive is stopped and a fault indication is given.

Operation limits

ACS800 has adjustable limits for speed, current (maximum), torque (maximum) and DC voltage.

Settings

Parameter group [20 LIMITS](#).

Power limit

Power limitation is used to protect the input bridge and the DC intermediate circuit. If the maximum allowed power is exceeded, the drive torque is automatically limited. Maximum overload and continuous power limits depend on the drive hardware. For specific values refer to the appropriate hardware manual.

Automatic resets

The drive can automatically reset itself after overcurrent, overvoltage, undervoltage and “analogue input below a minimum” faults. The Automatic Resets must be activated by the user.

Settings

Parameter group [31 AUTOMATIC RESET](#).

Supervisions

The drive monitors whether certain user selectable variables are within the user-defined limits. The user may set limits for speed, current etc.

The supervision functions operate on a 100 ms time level.

Settings

Parameter group [32 SUPERVISION](#).

Diagnostics

Actual Signals	Additional information
03.02	Supervision limit indicating bits in a packed boolean word
03.04	Supervision limit indicating bits in a packed boolean word
03.14	Supervision limit indicating bits in a packed boolean word
Group 14 RELAY OUTPUTS	Supervision limit indication through a relay output

Parameter lock

The user can prevent parameter adjustment by activating the parameter lock.

Settings

Parameters [16.02](#) and [16.03](#).

Process PID control

There is a built-in PID controller in the drive. The controller can be used to control process variables such as pressure, flow or fluid level.

When the process PID control is activated, a process reference (setpoint) is connected to the drive instead of a speed reference. An actual value (process feedback) is also brought back to the drive. The process PID control adjusts the drive speed in order to keep the measured process quantity (actual value) at the desired level (reference).

The control operates on a 24 ms time level.

Block diagrams

The block diagram below right illustrates the process PID control.

The figure on the left shows an application example: The controller adjusts the speed of a pressure boost pump according to the measured pressure and the set pressure reference.

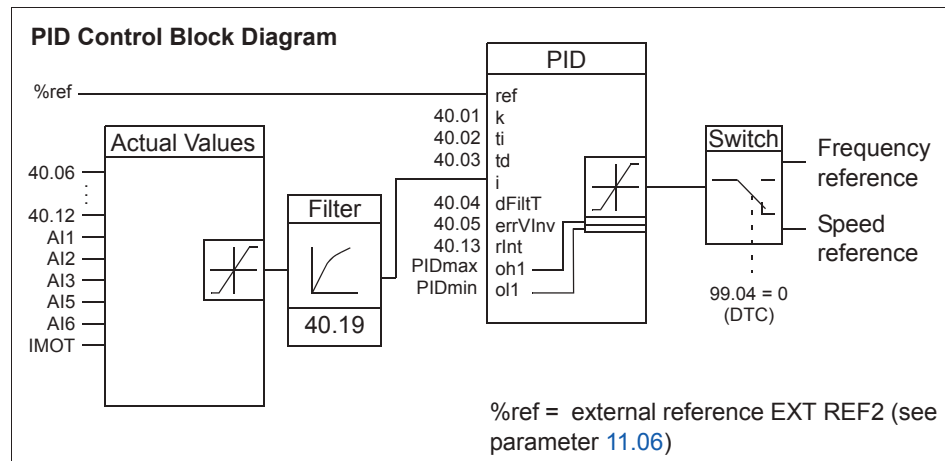
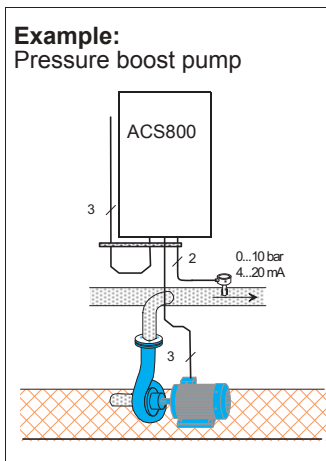

Settings

Parameter	Purpose
99.02	Process PID control activation
40.01...40.13, 40.19, 40.25...40.27	The settings of the process PID controller
32.13...32.18	The supervision limits for the process reference REF2 and the variables ACT1 and ACT2

Diagnostics

Actual Signals	Purpose
01.12, 01.24, 01.25, 01.26 and 01.34	PID process controller reference, actual values and error value
Group 14 RELAY OUTPUTS	Supervision limit exceeded indication through a relay output
Group 15 ANALOGUE OUTPUTS	PID process controller values through standard analogue outputs
Group 96 EXTERNAL AO	PID process controller values through optional analogue outputs

Sleep function for the process PID control

The sleep function operates on a 100 ms time level.

The block diagram below illustrates the sleep function enable/disable logic. The sleep function can be put into use only when the process PID control is active.

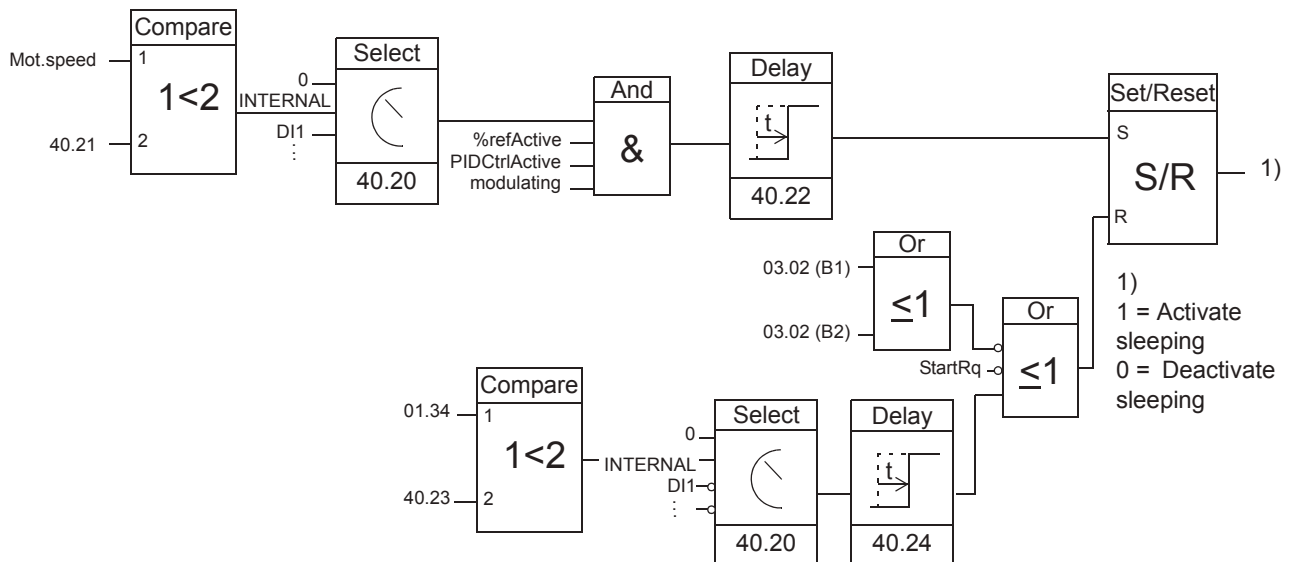

Mot.speed: Actual speed of the motor

%refActive: The % reference (EXT REF2) is in use. See parameter 11.02.

PIDCtrlActive: 99.02 is PID CTRL

modulating: The inverter IGBT control is operating

Example

The time scheme below visualises the operation of the sleep function.

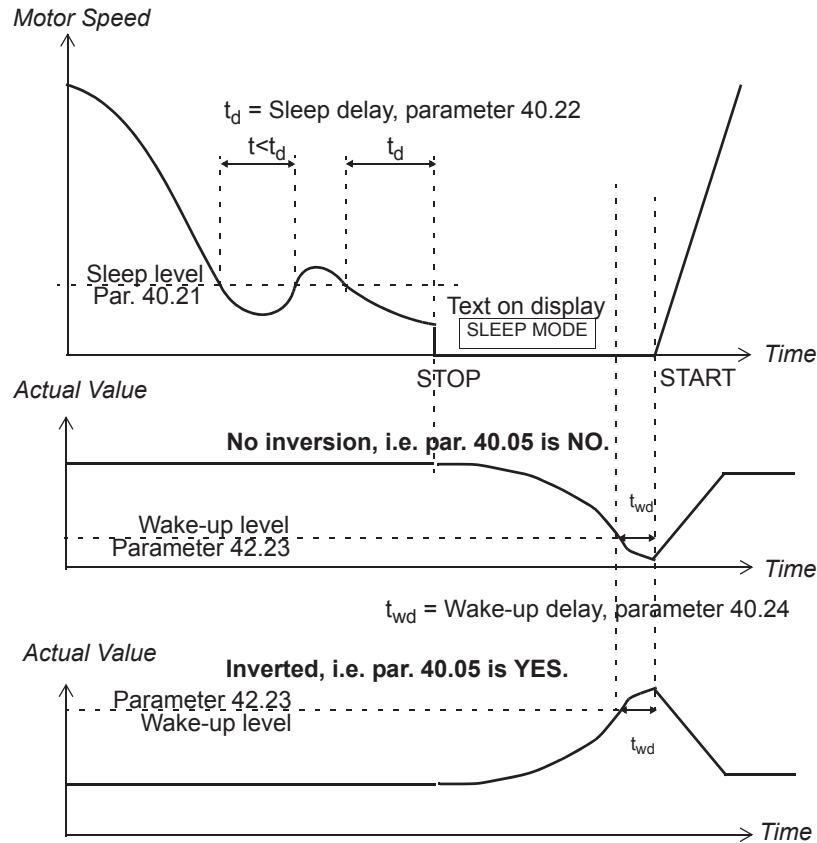

Sleep function for a PID controlled pressure boost pump: The water consumption falls at night. As a consequence, the PID process controller decreases the motor speed. However, due to natural losses in the pipes and the low efficiency of the centrifugal pump at low speeds, the motor does not stop but keeps rotating. The sleep function detects the slow rotation, and stops the unnecessary pumping after the sleep delay has passed. The drive shifts into sleep mode, still monitoring the pressure. The pumping restarts when the pressure falls under the allowed minimum level and the wake-up delay has passed.

Settings

Parameter	Additional information
99.02	Process PID control activation
40.05	Inversion
40.20...40.24	Sleep function settings

Diagnostics

Warning SLEEP MODE on the panel display.

Motor temperature measurement through the standard I/O

This section describes the temperature measurement of one motor when the drive control board RMIO is used as the connection interface.

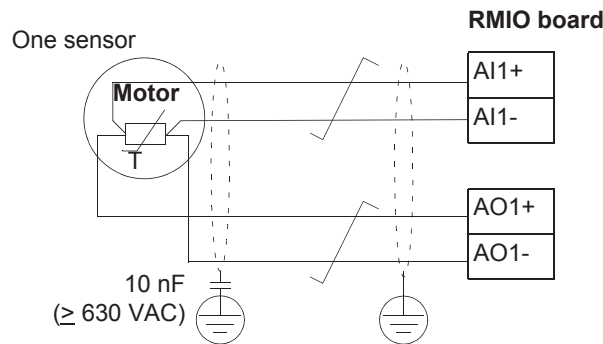

The minimum voltage of the capacitor must be 630 VAC.

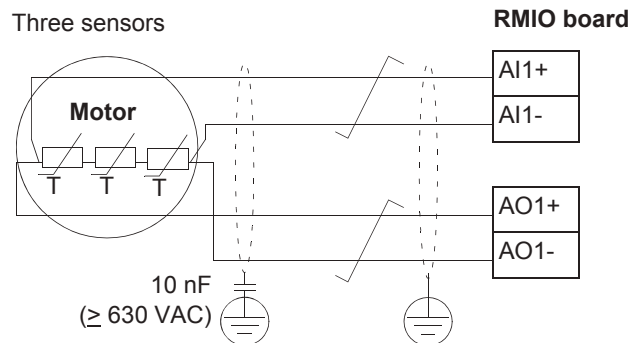

WARNING! According to IEC 664, the connection of the motor temperature sensor to the RMIO board, requires double or reinforced insulation between motor live parts and the sensor. Reinforced insulation entails a clearance and creepage distance of 8 mm (400 / 500 VAC equipment). If the assembly does not fulfil the requirement:

- The RMIO board terminals must be protected against contact and they may not be connected to other equipment.

Or

- The temperature sensor must be isolated from the RMIO board terminals.

See also section [Motor Thermal Protection](#) on page 64.

Settings

Parameter	Additional information
15.01	Analogue output in a motor 1 temperature measurement. Set to M1 TEMP MEAS.
35.01...35.03	Settings of motor 1 temperature measurement
Other	
Parameters 13.01 to 13.05 (AI1 processing) and 15.02 to 15.05 (AO1 processing) are not effective.	
At the motor end the cable shield should be earthed through a 10 nF capacitor. If this is not possible, the shield is to be left unconnected.	

Diagnostics

Actual values	Additional information
01.35	Temperature value
Warnings	
MOTOR 1 TEMP (4312)	Measured motor temperature has exceeded the set alarm limit.
T MEAS ALM (FF91)	Motor temperature measurement is out of acceptable range.
Faults	
MOTOR 1 TEMP (4312)	Measured motor temperature has exceeded the set fault limit.

Motor temperature measurement through an analogue I/O extension

This section describes the motor temperature measurement of one motor when an optional analogue I/O extension module RAIO is used as the connection interface.

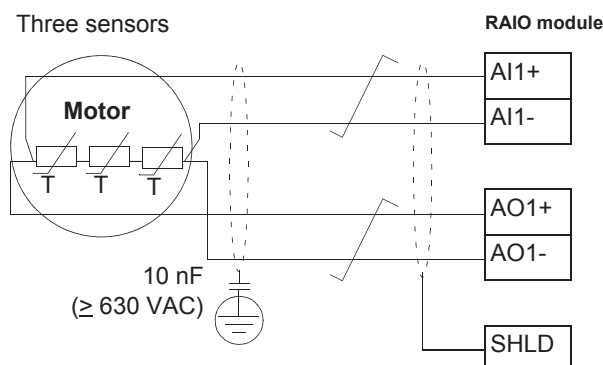
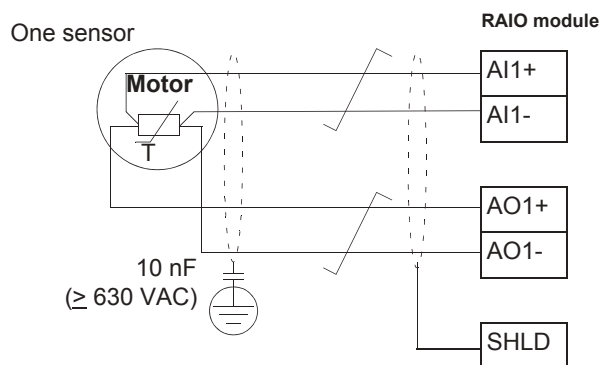

The minimum voltage of the capacitor must be 630 VAC.



WARNING! According to IEC 664, the connection of the motor temperature sensor to the RAIO module, requires double or reinforced insulation between motor live parts and the sensor. Reinforced insulation entails a clearance and creepage distance of 8 mm (400 / 500 VAC equipment). If the assembly does not fulfil the requirement:

- The RAIO module terminals must be protected against contact and they may not be connected to other equipment.

Or

- The temperature sensor must be isolated from the RAIO module terminals.

See also section [Motor Thermal Protection](#) on page 64.

Settings

Parameter	Additional information
35.01 ... 35.03	Settings of motor 1 temperature measurement
98.12	Activation of optional analogue I/O for motor temperature measurement
Other	
Parameters 13.16 to 13.20 (AI1 processing) and 96.01 to 96.05 (AO1 signal selection and processing) are not effective.	
At the motor end the cable shield should be earthed through a 10 nF capacitor. If this is not possible, the shield is to be left unconnected.	

Diagnostics

Actual values	Additional information
01.35	Temperature value
Warnings	
MOTOR 1 TEMP (4312)	Measured motor temperature has exceeded the set alarm limit
T MEAS ALM (FF91)	Motor temperature measurement is out of acceptable range.
Faults	
MOTOR 1 TEMP (4312)	Measured motor temperature has exceeded the set fault limit

Adaptive Programming using the function blocks

Conventionally, the user can control the operation of the drive by parameters. Each parameter has a fixed set of choices or a setting range. The parameters make the programming easy, but the choices are limited. The user cannot customise the operation any further. The Adaptive Program makes freer customising possible without the need of a special programming tool or language:

- The program is built of standard function blocks included in the drive application program.
- The control panel is the programming tool.
- The user can document the program by drawing it on block diagram template sheets.

The maximum size of the Adaptive Program is 15 function blocks. The program may consist of several separate functions.

For more information, see the *Application Guide for Adaptive Program* [3AFE64527274 (English)].

DriveAP

DriveAP is a Windows based tool for Adaptive Programming. With DriveAP it is possible to upload the Adaptive Program from the drive and edit it with PC.

For more information, see the *DriveAP User's Manual* [3AFE64540998 (English)].

Control of a mechanical brake

The mechanical brake is used for holding the motor and driven machinery at zero speed when the drive is stopped, or not powered.

Example

The figure below shows a brake control application example.



WARNING! Make sure that the machinery into which the drive with brake control function is integrated fulfils the personnel safety regulations. Note that the frequency converter (a Complete Drive Module or a Basic Drive Module, as defined in IEC 61800-2), is not considered as a safety device mentioned in the European Machinery Directive and related harmonised standards. Thus, the personnel safety of the complete machinery must not be based on a specific frequency converter feature (such as the brake control function), but it has to be implemented as defined in the application specific regulations.

Brake control logic is integrated in the drive application program. The brake control hardware and wirings needs to be done by the user.

- Brake on/off control through relay output RO1.
- Brake supervision through digital input DI5 (optional).
- Emergency brake switch in the brake control circuit.

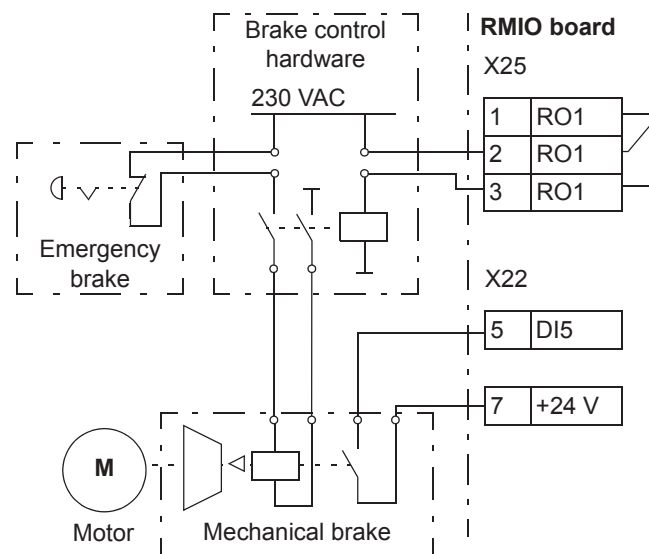

Operation time scheme

The time scheme below illustrates the operation of the brake control function. See also the state machine on the following page.

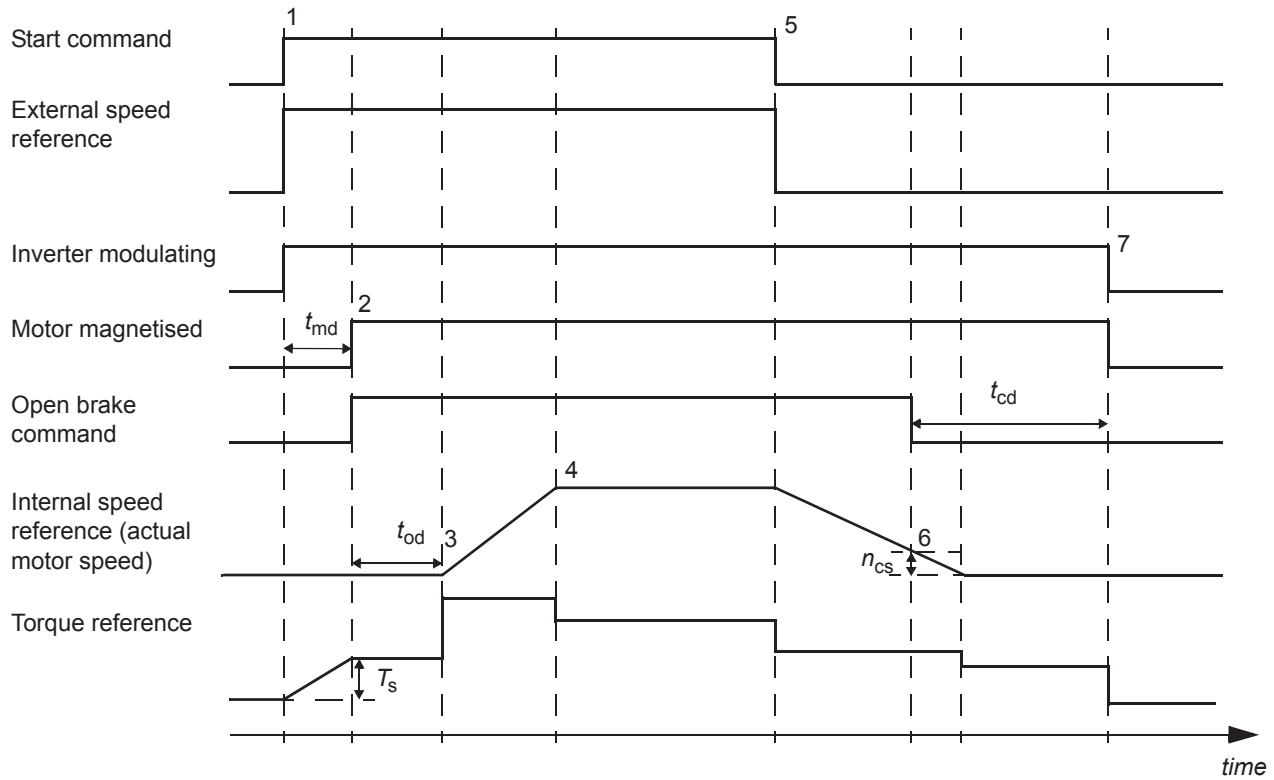

T_s	Start torque at brake release (Parameter 42.07 and 42.08)
t_{md}	Motor magnetising delay
t_{od}	Brake open delay (Parameter 42.03)
n_{cs}	Brake close speed (Parameter 42.05)
t_{cd}	Brake close delay (Parameter 42.04)

State shifts

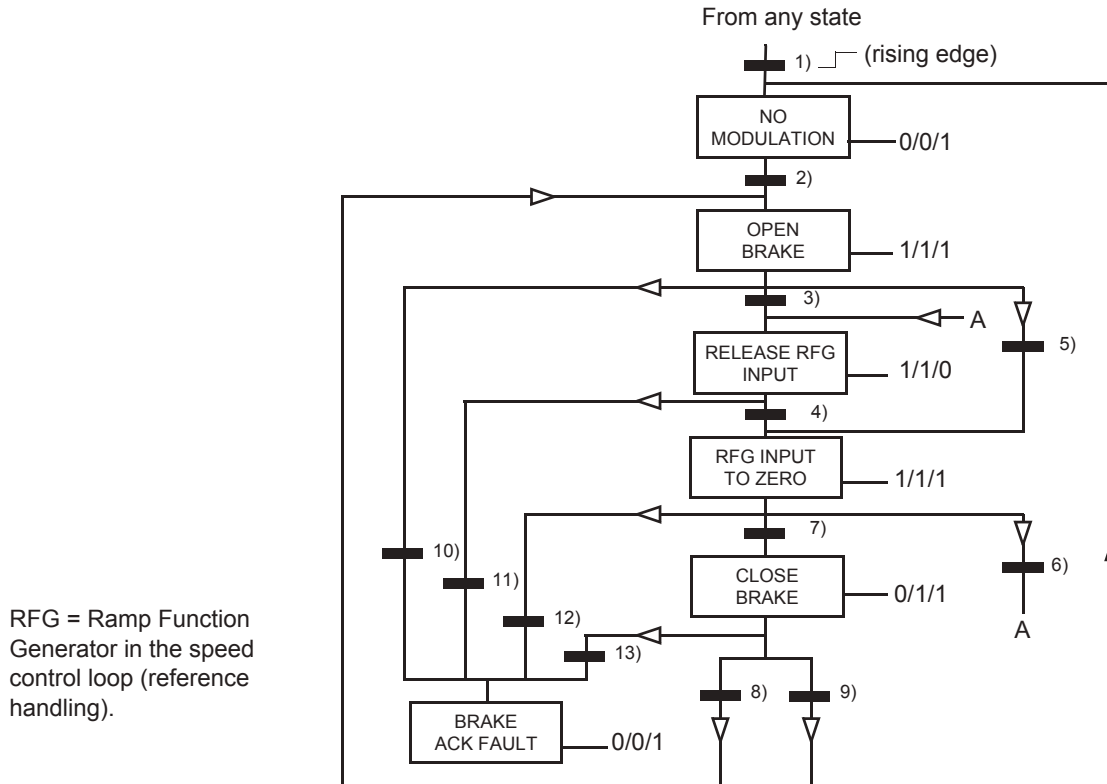

RFG = Ramp Function Generator in the speed control loop (reference handling).

State (Symbol NN — X/Y/Z)

- NN: State name

- X/Y/Z: State outputs/operations

X = 1 Open the brake. The relay output set to brake on/off control energises.

Y = 1 Forced start. The function keeps the internal Start on until the brake is closed in spite of the status of the external Start signal.

Z = 1 Ramp in zero. Forces the used speed reference (internal) to zero along a ramp.

State change conditions (Symbol)

1) Brake control active 0 -> 1 OR Inverter is modulating = 0

2) Motor magnetised = 1 AND Drive running = 1

3) Brake acknowledgement = 1 AND Brake open delay passed AND Start = 1

4) Start = 0

5) Start = 0

6) Start = 1

7) |Actual motor speed| < Brake close speed AND Start = 0

8) Start = 1

9) Brake acknowledgement = 0 AND Brake close delay passed = 1 AND Start = 0

Only if parameter 42.02 ≠ OFF:

10) Brake acknowledgement = 0 AND Brake open delay passed = 1

11) Brake acknowledgement = 0

12) Brake acknowledgement = 0

13) Brake acknowledgement = 1 AND Brake close delay passed = 1

Settings

Parameter	Additional information
14.01	Relay output for the brake control (set to BRAKE CTRL)
Group 42 BRAKE CONTROL	Brake function settings

Diagnostics

Actual value	Additional information
03.01	Ramp in zero bit
03.13	The state of bit "brake open/close command"
Warnings	
BRAKE ACKN (FF74)	Unexpected state of brake acknowledge signal
Faults	
BRAKE ACKN (FF74)	Unexpected state of brake acknowledge signal

Master/Follower use of several drives

In a Master/Follower application, the system is run by several drives, the motor shafts of which are coupled to each other. The master and follower drives communicate via a fibre optic link. The figures below illustrate two basic application types.

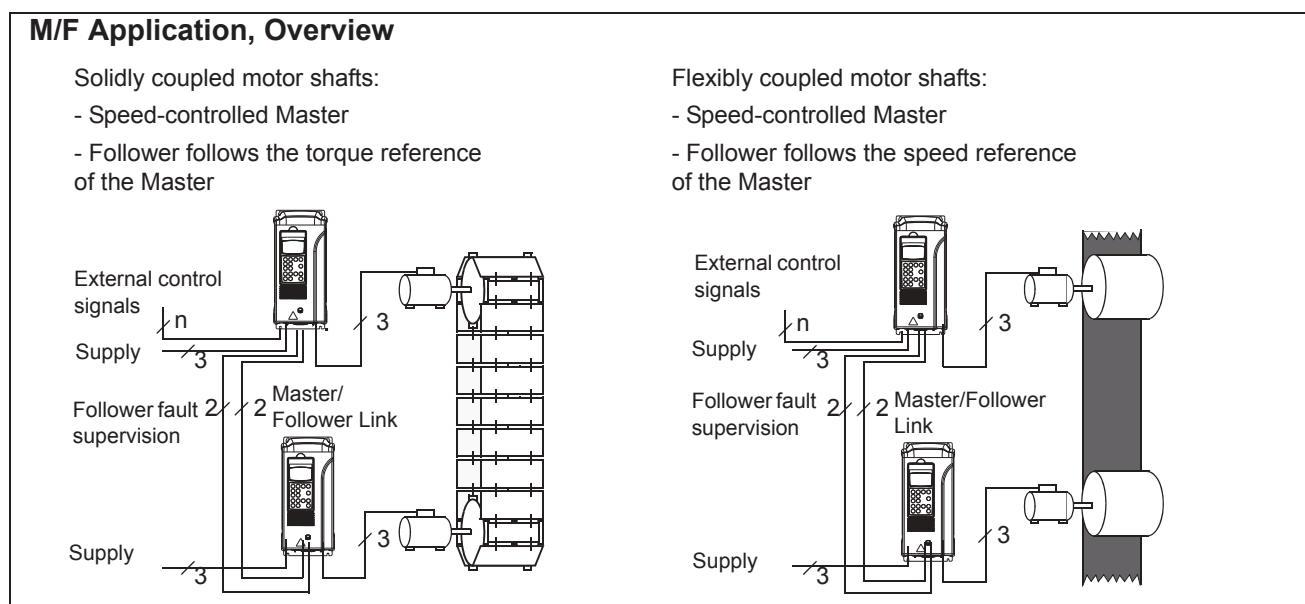

Settings and diagnostics

Parameter	Additional information
Group 60 MASTER/FOLLOWER	Master/Follower parameters
Other	
<i>Master/Follower Application Guide [3AFE64590430 (English)] explains the functionality in further detail.</i>	

Jogging

The jogging function is typically used to control a cyclical movement of a machine section. One push button controls the drive through the whole cycle: When it is on, the drive starts, accelerates to a preset speed at a preset rate. When it is off, the drive decelerates to zero speed at a preset rate.

The figure and table below describe the operation of the drive. They also represent how the drive shifts to normal operation (= jogging inactive) when the drive start command is switched on. Jog cmd = State of the jogging input, Start cmd = State of the drive start command.

The function operates on a 100 ms time level.

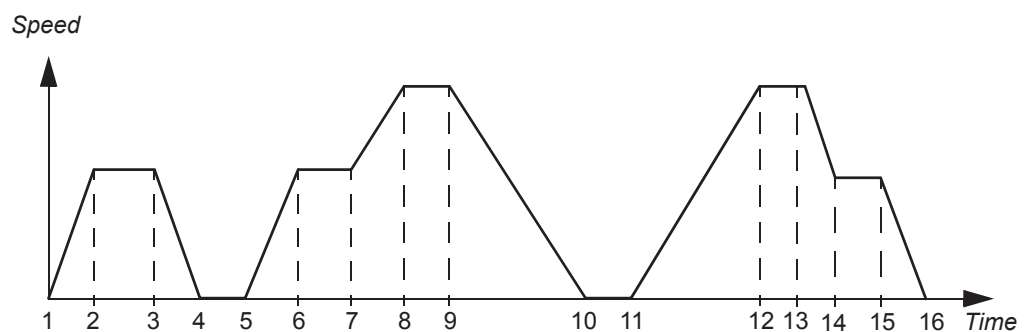

Phase	Jog cmd	Start cmd	Description
1-2	1	0	Drive accelerates to the jogging speed along the acceleration ramp of the jogging function.
2-3	1	0	Drive runs at the jogging speed.
3-4	0	0	Drive decelerates to zero speed along the deceleration ramp of the jogging function.
4-5	0	0	Drive is stopped.
5-6	1	0	Drive accelerates to the jogging speed along the acceleration ramp of the jogging function.
6-7	1	0	Drive runs at the jogging speed.
7-8	x	1	Normal operation overrides the jogging. Drive accelerates to the speed reference along the active acceleration ramp.
8-9	x	1	Normal operation overrides the jogging. Drive follows the speed reference.
9-10	0	0	Drive decelerates to zero speed along the active deceleration ramp.
10-11	0	0	Drive is stopped.
11-12	x	1	Normal operation overrides the jogging. Drive accelerates to the speed reference along the active acceleration ramp.
12-13	x	1	Normal operation overrides the jogging. Drive follows the speed reference.
13-14	1	0	Drive decelerates to the jogging speed along the deceleration ramp of the jogging function.
14-15	1	0	Drive runs at the jogging speed.
15-16	0	0	Drive decelerates to zero speed along the deceleration ramp of the jogging function.

x = State can be either 1 or 0.

Note: The jogging is not operational when:

- the drive start command is on, or
- the drive is in local control (L visible on the first row of the panel display).

Note: The jogging speed overrides the constant speeds.

Note: The ramp shape time is set to zero during the jogging.

Settings

Parameter	Additional information
10.06	Input for the on/off control of the jogging.
12.15	Jogging speed
21.10	Switch off delay for the inverter IGBT control. A delay keeps the inverter modulation live over a short standstill period enabling a smooth restart.
22.04, 22.05	Acceleration and deceleration times used during the jogging.
22.06	Acceleration and deceleration ramp shape time: Set to zero during the jogging.

Reduced Run function

Reduced Run function is available for parallel connected inverters. Reduced Run function makes it possible to continue the operation with limited current if an inverter module(s) is out of order. If one of the modules is broken, it must be removed. Parameter change is needed to continue the run with reduced current (95.03 INT CONFIG USER). For instructions on how to remove and reconnect an inverter module, see the appropriate drive hardware manual.

Settings

Parameter	Additional information
95.03 INT CONFIG USER	Number of existing parallel connected inverters

Diagnostics

Actual value	Additional information
04.01	INT board fault
Faults	
INT CONFIG	Number of inverter modules is not equal to original number of inverters.

User load curve

Motor temperature rise can be limited by limiting the drive output current. The user can define a load curve (output current as a function of frequency). The load curve is defined by eight points by parameters 72.02...72.17. If the load curve is exceeded, a fault / warning / current limitation is activated.

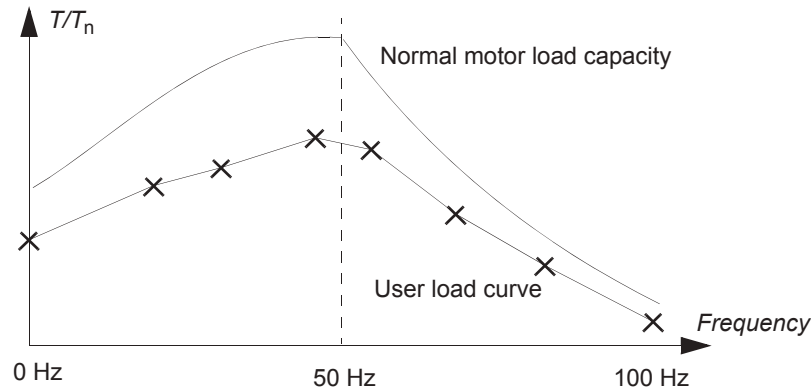

Overload

Overload supervision can be applied to the user load curve by setting parameters 72.18 LOAD CURRENT LIMIT... 72.20 COOLING TIME according to the overload values defined by the motor manufacturer.

The supervision is based on an integrator, $\int I^2 dt$. Whenever the drive output current exceeds the user load curve, the integrator is started. When the integrator has reached the overload limit defined by parameters 72.18 and 72.19, the drive reacts as defined by parameter 72.01 OVERLOAD FUNC. The output of the integrator is set to zero if the current stays continuously below the user load curve for the cooling time defined by parameter 72.20 COOLING TIME.

If the overload time 72.19 LOAD THERMAL TIME is set to zero, the drive output current is limited to the user load curve.

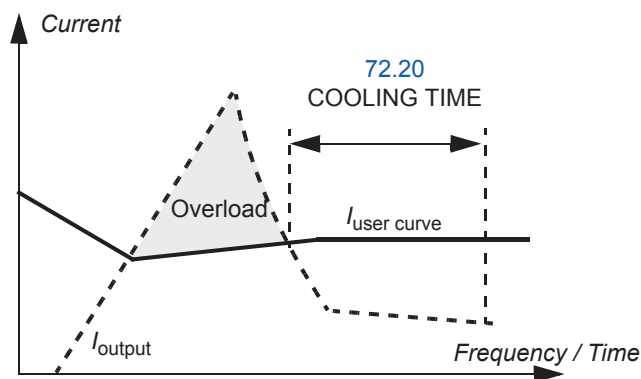

Settings

Parameter	Additional information
Group 72 USER LOAD CURVE	User load curve

Diagnostics

Actual value	Additional information
02.20	Measured motor current in percent of the user load curve current
Warnings	
USER L CURVE	Integrated motor current has exceeded load curve.
Faults	
USER L CURVE	Integrated motor current has exceeded load curve.

Application macros

Chapter overview

This chapter describes the intended use, operation and the default control connections of the standard application macros. It also describes how to save a user macro, and how to recall it.

Overview of macros

Application macros are preprogrammed parameter sets. While starting up the drive, the user typically selects one of the macros - the one that is best suited to his needs - by parameter 99.02, makes the essential changes and saves the result as a user macro.

There are five standard macros and two user macros. The table below contains a summary of the macros and describes suitable applications.

Macro	Suitable Applications
Factory	Ordinary speed control applications where no, one, two or three constant speeds are used: <ul style="list-style-type: none"> - Conveyors - Speed-controlled pumps and fans - Test benches with predefined constant speeds
Hand/Auto	Speed control applications. Switching between two external control devices is possible.
PID Control	Process control applications e.g. different closed loop control systems such as pressure control, level control, and flow control. For example: <ul style="list-style-type: none"> - pressure boost pumps of municipal water supply systems - level controlling pumps of water reservoirs - pressure boost pumps of district heating systems - material flow control on a conveyor line. It is also possible to switch between process and speed control.
Torque Control	Torque control applications. Switching between torque and speed control is possible.
Sequential Control	Speed control applications in which speed reference, seven constant speeds and two acceleration and deceleration ramps can be used.
User	The user can save the customised standard macro i.e. the parameter settings including group 99, and the results of the motor identification into the permanent memory, and recall the data at a later time. Two user macros are essential when switching between two different motors is required

Note on external power supply

External +24 V power supply for the RMIO board is recommended if

- the application requires a fast start after connecting the input power supply
- fieldbus communication is required when the input power supply is disconnected.

The RMIO board can be supplied from an external power source via terminal X23 or X34 or via both X23 and X34. The internal power supply to terminal X34 can be left connected when using terminal X23.



WARNING! If the RMIO board is supplied from an external power source via terminal X34, the loose end of the cable removed from the RMIO board terminal must be secured mechanically to a location where it cannot come into contact with electrical parts. If the screw terminal plug of the cable is removed, the wire ends must be individually insulated.

Parameter settings

In Standard Control Program, set parameter [16.09](#) CTRL BOARD SUPPLY to EXTERNAL 24V if the RMIO board is powered from an external supply.

Factory macro

All drive commands and reference settings can be given from the control panel or from an external control location. The active control location is selected with the **LOC/REM** key of the panel. The drive is speed-controlled.

In external control, the control location is EXT1. The reference signal is connected to analogue input AI1 and Start/Stop and Direction signals are connected to digital inputs DI1 and DI2. By default, the direction is fixed to FORWARD (parameter 10.03). DI2 does not control the direction of rotation unless parameter 10.03 is changed to REQUEST.

Three constant speeds are selected by digital inputs DI5 and DI6. Two acceleration/ deceleration ramps are preset. The acceleration and deceleration ramps are used according to the state of digital input DI4.

Two analogue signals (speed and current) and three relay output signals (ready, running and inverted fault) are available.

The default signals on the display of the control panel are FREQUENCY, CURRENT and POWER.

Default control connections

The figure below shows the external control connections for the Factory macro. The markings of the standard I/O terminals on the RMIO board are shown.

1) Effective only if parameter 10.03 is switched to REQUEST by the user.

2) The US default settings differ as follows:

DI1	Start (Pulse: 0->1)
DI2	Stop (Pulse: 1->0)
DI3	Forward/Reverse

3) 0 = ramp times according to par. 22.02 and 22.03. 1 = ramp times according to par. 22.04 and 22.05.

4) See parameter group 12
CONSTANT SPEEDS:

DI5	DI6	Operation
0	0	Set speed through AI1
1	0	Speed 1
0	1	Speed 2
1	1	Speed 3

5) See parameter 21.09.

6) Total maximum current shared between this output and optional modules installed on the board.

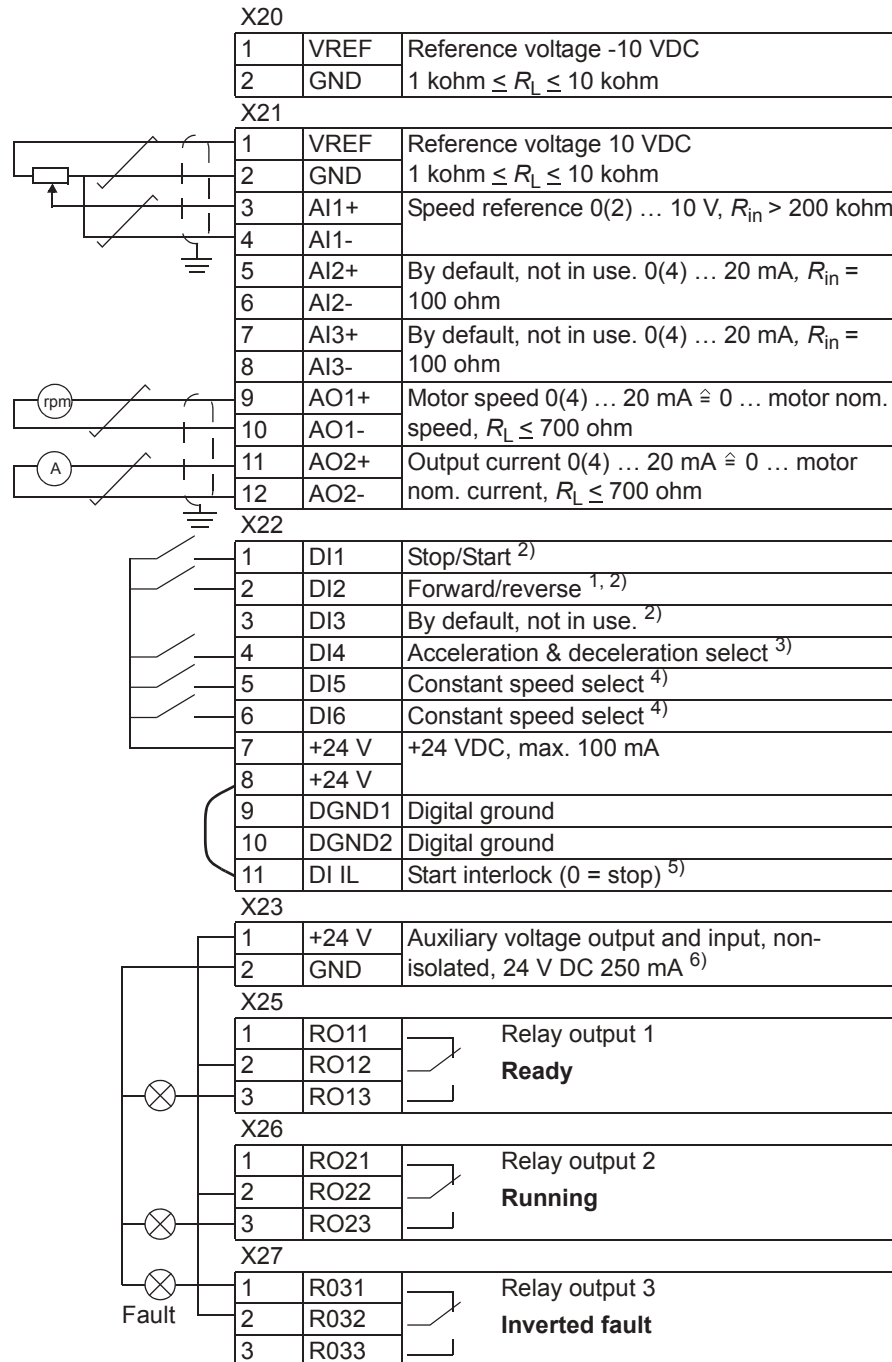

Hand/Auto macro

Start/Stop and Direction commands and reference settings can be given from one of two external control locations, EXT1 (Hand) or EXT2 (Auto). The Start/Stop/Direction commands of EXT1 (Hand) are connected to digital inputs DI1 and DI2, and the reference signal is connected to analogue input AI1. The Start/Stop/Direction commands of EXT2 (Auto) are connected to digital inputs DI5 and DI6, and the reference signal is connected to analogue input AI2. The selection between EXT1 and EXT2 is dependent on the status of digital input DI3. The drive is speed controlled. Speed reference and Start/Stop and Direction commands can be given from the control panel keypad also. One constant speed can be selected through digital input DI4.

Speed reference in Auto Control (EXT2) is given as a percentage of the maximum speed of the drive.

Two analogue and three relay output signals are available on terminal blocks. The default signals on the display of the control panel are FREQUENCY, CURRENT and CTRL LOC.

Default control connections

The figure below shows the external control connections for the Hand/Auto macro. The markings of the standard I/O terminals on the RMIO board are shown.

1) Selection between two external control locations, EXT1 and EXT2.

2) See parameter 21.09.

3) Total maximum current shared between this output and optional modules installed on the board.

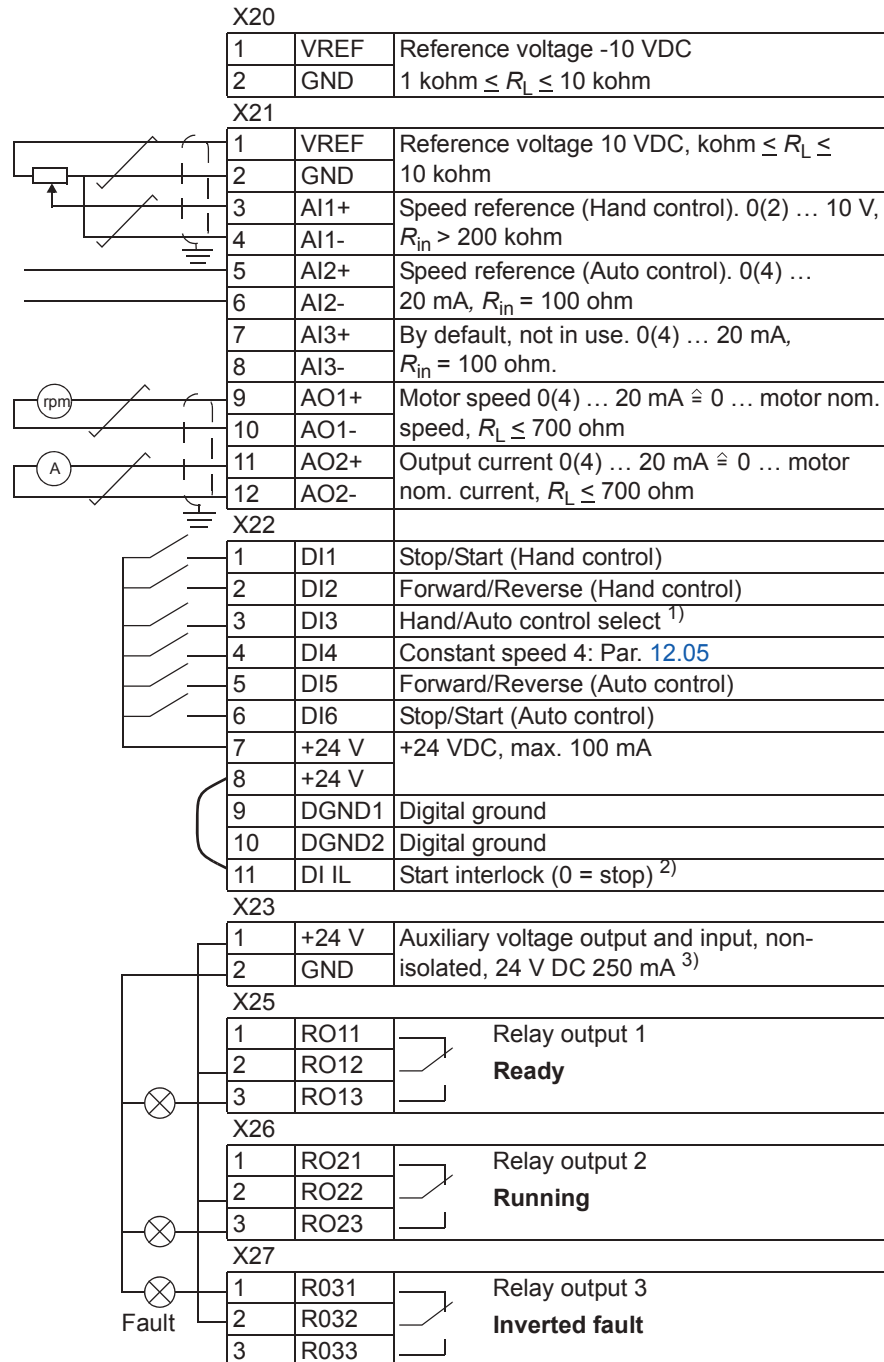

PID Control macro

The PID Control macro is used for controlling a process variable – such as pressure or flow – by controlling the speed of the driven motor.

Process reference signal is connected to analogue input AI1 and process feedback signal to analogue input AI2.

Alternatively, a direct speed reference can be given to the drive through analogue input AI1. Then the PID controller is bypassed and the drive no longer controls the process variable. Selection between the direct speed control and the process variable control is done with digital input DI3.

Two analogue and three relay output signals are available on terminal blocks. The default signals on the display of the control panel are SPEED, ACTUAL VALUE1 and CONTROL DEVIATION.

Connection example, 24 VDC / 4...20 mA two-wire sensor

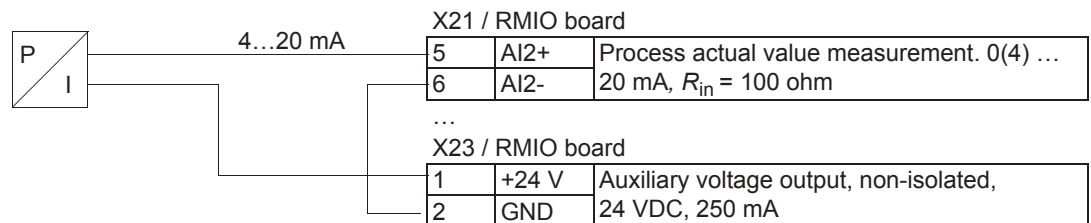

Note: The sensor is supplied through its current output. Thus the output signal must be 4...20 mA, not 0...20 mA.

Default control connections

The figure below shows the external control connections for the PID Control macro. The markings of the standard I/O terminals on the RMIO board are shown.

1) Selection between two external control locations, EXT1 and EXT2

2) In use only when the speed control is active (DI3 = 0)

3) Off = Run Enable off. Drive will not start or stops. On = Run Enable on. Normal operation.

4) See parameter 21.09.

5) The sensor needs to be powered. See the manufacturer's instructions. A connection example of a two-wire 24 VDC / 4...20 mA sensor is shown on previous page.

6) Total maximum current shared between this output and optional modules installed on the board.

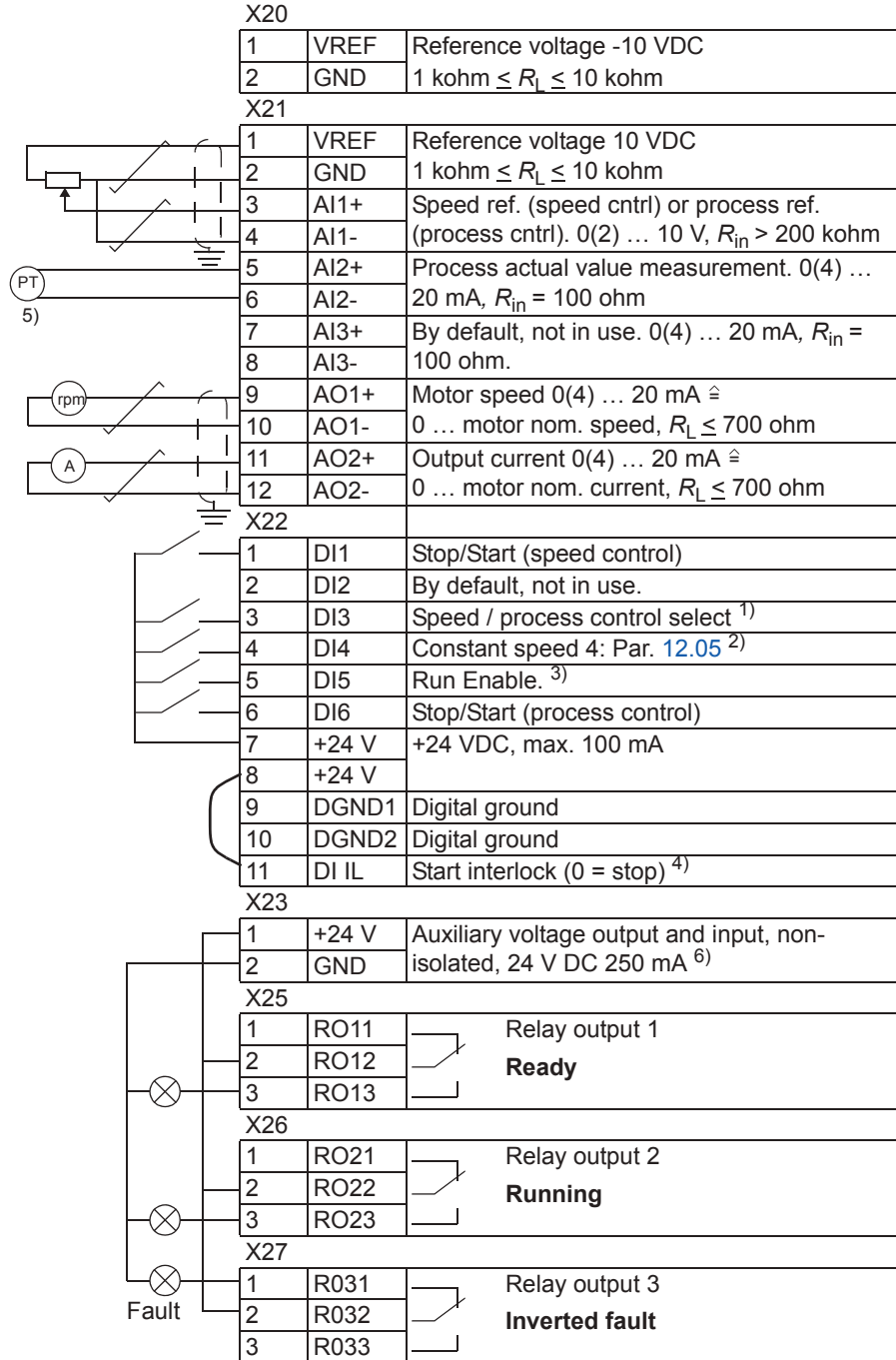

Torque Control macro

Torque Control macro is used in applications in which torque control of the motor is required. Torque reference is given through analogue input AI2 as a current signal. By default, 0 mA corresponds to 0 %, and 20 mA to 100 % of the rated motor torque. The Start/Stop/Direction commands are given through digital inputs DI1 and DI2. The Run Enable signal is connected to DI6.

Through digital input DI3 it is possible to select speed control instead of torque control. It is also possible to change the external control location to local (i.e. to control panel) by pressing the **LOC/REM** key. The panel controls the speed by default. If torque control with panel is required, the value of parameter 11.01 should be changed to REF2 (%).

Two analogue and three relay output signals are available on terminal blocks. The default signals on the display of the control panel are SPEED, TORQUE and CTRL LOC.

Default control connections

The figure below shows the external control connections for the Torque Control macro. The markings of the standard I/O terminals on the RMIO board are shown.

1) Selection between external control locations EXT1 and EXT2

2) In use only when the speed control is active (DI3 = 0)

3) Off = Ramp times according to par. 22.02 and 22.03. On = Ramp times according to par. 22.04 and 22.05.

4) Off = Run Enable off. Drive will not start or stops. On = Run Enable on. Normal operation.

5) See parameter 21.09.

6) Total maximum current shared between this output and optional modules installed on the board.

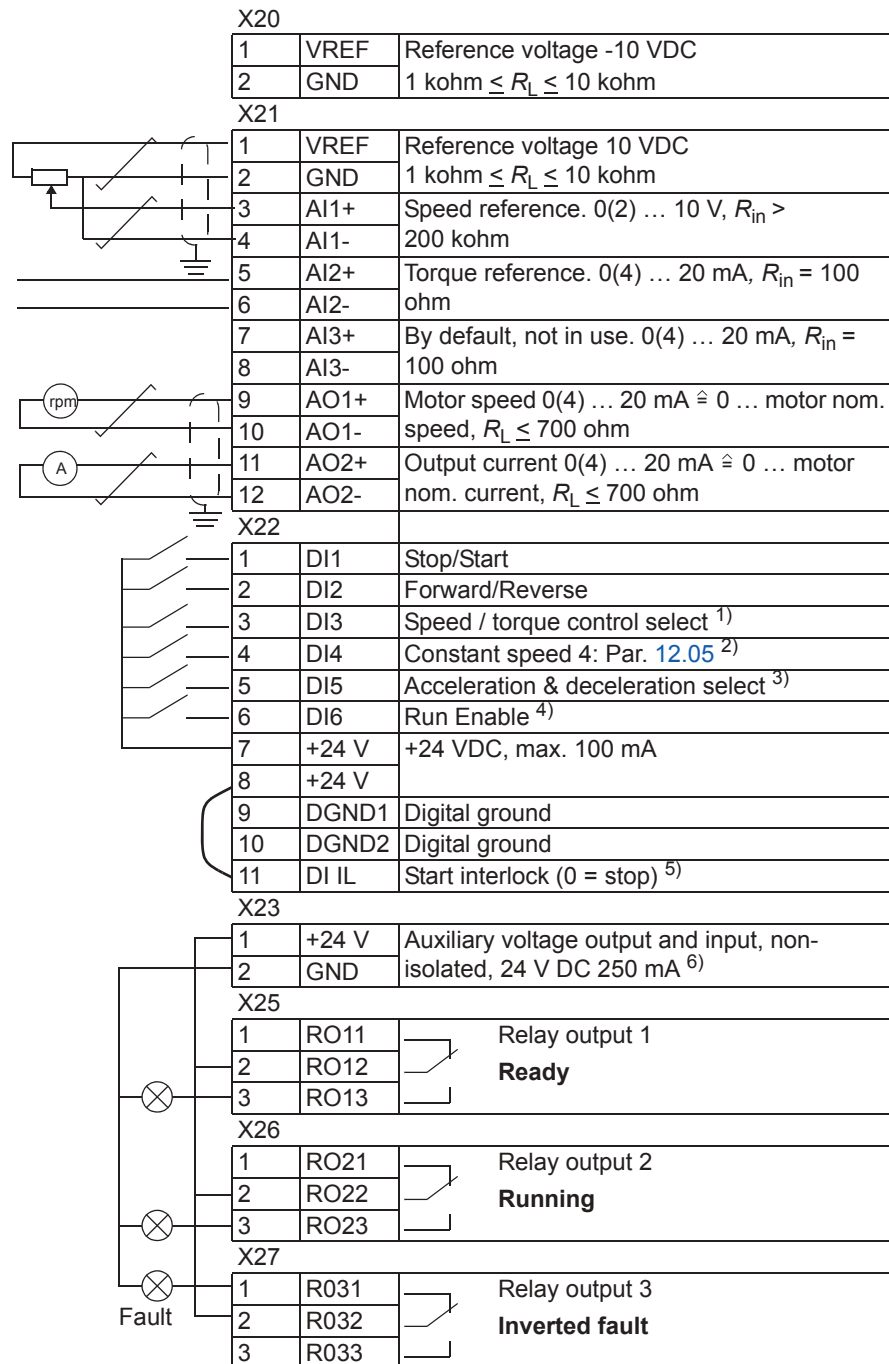

Sequential Control macro

This macro offers seven preset constant speeds which can be activated by digital inputs DI4 to DI6. Two acceleration/deceleration ramps are preset. The acceleration and deceleration ramps are applied according to the state of digital input DI3. The Start/Stop and Direction commands are given through digital inputs DI1 and DI2.

External speed reference can be given through analogue input AI1. The reference is active only when all of the digital inputs DI4 to DI6 are 0 VDC. Giving operational commands and setting reference is possible also from the control panel.

Two analogue and three relay output signals are available on terminal blocks. Default stop mode is ramp. The default signals on the display of the control panel are FREQUENCY, CURRENT and POWER.

Operation diagram

The figure below shows an example of the use of the macro.

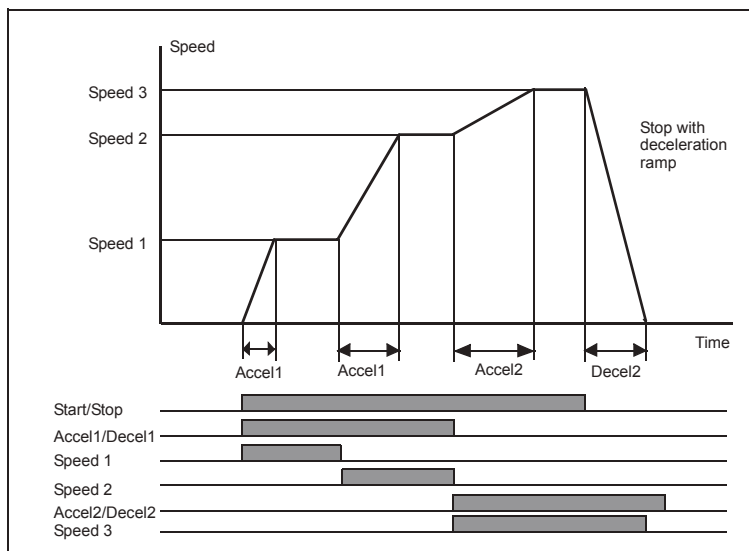

Default control connections

The figure below shows the external control connections for the Sequential Control macro. The markings of the standard I/O terminals on the RMIO board are shown.

¹⁾ Off = Ramp times according to par. 22.02 and 22.03. On = Ramp times according to par. 22.04 and 22.05.

²⁾ See parameter group 12 CONSTANT SPEEDS:

DI4	DI5	DI6	Operation
0	0	0	Set speed through AI1
1	0	0	Speed 1
0	1	0	Speed 2
1	1	0	Speed 3
0	0	1	Speed 4
1	0	1	Speed 5
0	1	1	Speed 6
1	1	1	Speed 7

³⁾ See parameter 21.09.

⁴⁾ Total maximum current shared between this output and optional modules installed on the board.

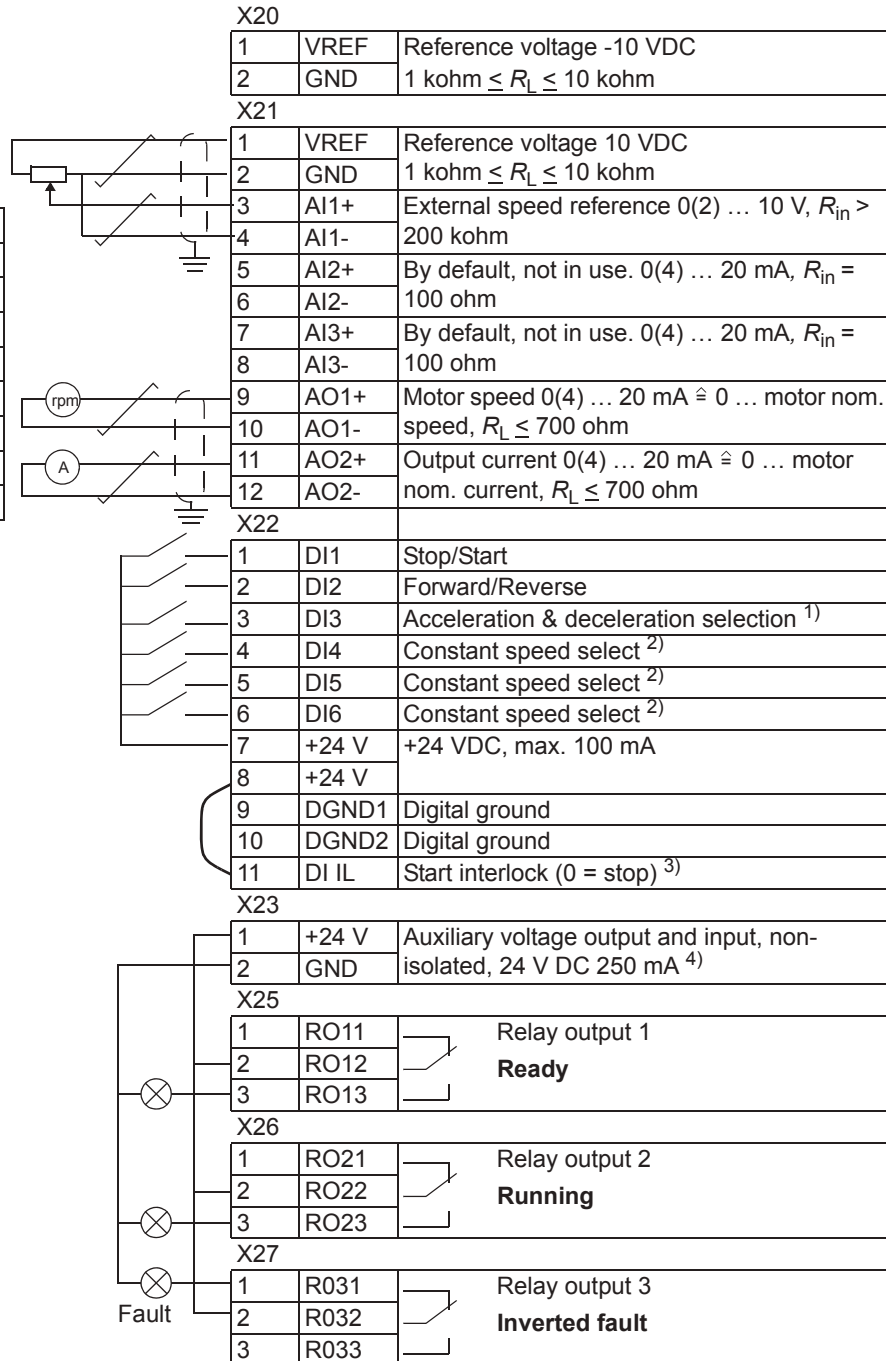

User macros

In addition to the standard application macros, it is possible to create two user macros. The user macro allows the user to save the parameter settings including Group 99, and the results of the motor identification into the permanent memory, and recall the data at a later time. The panel reference is also saved, if the macro is saved and loaded in Local control mode. Remote control location setting is saved into the user macro, but Local control location setting is not.

To create User Macro 1:

- Adjust the parameters. Perform the motor identification if not performed yet.
- Save the parameter settings and the results of the motor identification by changing parameter [99.02](#) to USER 1 SAVE (press ENTER). The storing takes 20 s to 1 min.

Note: If user macro save function is executed several times, drive memory fills up and file compression starts. File compression can last up to 10 minutes. Macro saving will be completed after the file compression. (Operation is indicated on the last row of the control panel display by blinking dots).

To recall the user macro:

- Change parameter [99.02](#) to USER 1 LOAD.
- Press **ENTER** to load.

The user macro can also be switched via digital inputs (see parameter [16.05](#)).

Note: User macro load restores also the motor settings in group [99 START-UP DATA](#) and the results of the motor identification. Check that the settings correspond to the motor used.

Example: The user can switch the drive between two motors without having to adjust the motor parameters and to repeat the motor identification every time the motor is changed. The user needs only to adjust the settings and perform the motor identification once for both motors and then to save the data as two user macros. When the motor is changed, only the corresponding User macro needs to be loaded, and the drive is ready to operate.

www.nicsanat.com

021-87700210

NIC SANAT

نیک صنعت



Actual signals and parameters

Chapter overview

The chapter describes the actual signals and parameters and gives the fieldbus equivalent values for each signal/parameter. More data is given in chapter [Additional data: actual signals and parameters](#).

Terms and abbreviations

Term	Definition
Absolute Maximum Frequency	Value of 20.08, or 20.07 if the absolute value of the minimum limit is greater than the maximum limit.
Absolute Maximum Speed	Value of parameter 20.02, or 20.01 if the absolute value of the minimum limit is higher than the maximum limit.
Actual signal	Signal measured or calculated by the drive. Can be monitored by the user. No user setting possible.
FbEq	Fieldbus equivalent: The scaling between the value shown on the panel and the integer used in serial communication.
Parameter	A user-adjustable operation instruction of the drive.

No.	Name/Value	Description	FbEq
01 ACTUAL SIGNALS			
01.01	PROCESS VARIABLE	Process variable based on settings in parameter group 34 PROCESS VARIABLE .	1 = 1
01.02	SPEED	Calculated motor speed in rpm. Filter time setting by parameter 34.04 .	-20000 = -100% 20000 = 100% of motor abs. max. speed
01.03	FREQUENCY	Calculated drive output frequency.	-100 = -1 Hz 100 = 1 Hz
01.04	CURRENT	Measured motor current.	10 = 1 A
01.05	TORQUE	Calculated motor torque. 100 is the motor nominal torque. Filter time setting by parameter 34.05 .	-10000 = -100% 10000 = 100% of motor nom. torque
01.06	POWER	Motor power. 100 is the nominal power.	-1000 = -100% 1000 = 100% of motor nom. power
01.07	DC BUS VOLTAGE V	Measured intermediate circuit voltage.	1 = 1 V
01.08	MAINS VOLTAGE	Calculated supply voltage.	1 = 1 V
01.09	OUTPUT VOLTAGE	Calculated motor voltage.	1 = 1 V
01.10	ACS800 TEMP	Calculated IGBT temperature.	10 = 1%
01.11	EXTERNAL REF 1	External reference REF1 in rpm. (Hz if value of parameter 99.04 is SCALAR.)	1 = 1 rpm
01.12	EXTERNAL REF 2	External reference REF2. Depending on the use, 100% is the motor maximum speed, motor nominal torque, or maximum process reference.	0 = 0% 10000 = 100% 1)
01.13	CTRL LOCATION	Active control location. (1,2) LOCAL; (3) EXT1; (4) EXT2. See section Local control vs. external control on page 43.	See descr.
01.14	OP HOUR COUNTER	Elapsed time counter. Runs when the control board is powered.	1 = 1 h
01.15	KILOWATT HOURS	kWh counter. Counts inverter output kWh during operation (motor side - generator side).	1 = 100 kWh
01.16	APPL BLOCK OUTPUT	Application block output signal. E.g. the process PID controller output when the PID Control macro is active.	0 = 0% 10000 = 100%
01.17	DI6-1 STATUS	Status of digital inputs. Example: 0000001 = DI1 is on, DI2 to DI6 are off.	
01.18	AI1 [V]	Value of analogue input AI1.	1 = 0.001 V
01.19	AI2 [mA]	Value of analogue input AI2.	1 = 0.001 mA
01.20	AI3 [mA]	Value of analogue input AI3.	1 = 0.001 mA
01.21	RO3-1 STATUS	Status of relay outputs. Example: 001 = RO1 is energised, RO2 and RO3 are de-energised.	
01.22	AO1 [mA]	Value of analogue output AO1.	1 = 0.001 mA

No.	Name/Value	Description	FbEq
01.23	AO2 [mA]	Value of analogue output AO2.	1 = 0.001 mA
01.24	ACTUAL VALUE 1	Feedback signal for the process PID controller. Updated only when parameter 99.02 = PD CTRL.	0 = 0% 10000 = 100%
01.25	ACTUAL VALUE 2	Feedback signal for the process PID controller. Updated only when parameter 99.02 = PID CTRL.	0 = 0% 10000 = 100%
01.26	CONTROL DEVIATION	Deviation of the process PID controller, i.e. the difference between the reference value and the actual value. Updated only when parameter 99.02 = PID CTRL.	-10000 = -100% 10000 = 100%
01.27	APPLICATION MACRO	Active application macro (value of parameter 99.02).	See 99.02
01.28	EXT AO1 [mA]	Value of output 1 of the analogue I/O extension module (optional).	1 = 0.001 mA
01.29	EXT AO2 [mA]	Value of output 2 of the analogue I/O extension module (optional).	1 = 0.001 mA
01.30	PP 1 TEMP	Measured heatsink temperature in inverter no. 1.	1 = 1°C
01.31	PP 2 TEMP	Measured heatsink temperature in inverter no. 2 (used only in high power units with parallel inverters).	1 = 1°C
01.32	PP 3 TEMP	Measured heatsink temperature in inverter no. 3 (used only in high power units with parallel inverters).	1 = 1°C
01.33	PP 4 TEMP	Measured heatsink temperature in inverter no. 4 (used only in high power units with parallel inverters).	1 = 1°C
01.34	ACTUAL VALUE	Process PID controller actual value. See parameter 40.06 .	0 = 0% 10000 = 100%
01.35	MOTOR 1 TEMP	Measured temperature of motor 1. See parameter 35.01 .	1 = 1°C/ohm
01.36	MOTOR 2 TEMP	Measured temperature of motor 2. See parameter 35.04 .	1 = 1°C/ohm
01.37	MOTOR TEMP EST	Estimated motor temperature. Signal value is saved at power switch off.	1 = 1°C
01.38	AI5 [mA]	Value of analogue input AI5 read from AI1 of the analogue I/O extension module (optional). A voltage signal is also displayed in mA (instead of V).	1 = 0.001 mA
01.39	AI6 [mA]	Value of analogue input AI6 read from AI2 of the analogue I/O extension module (optional). A voltage signal is also displayed in mA (instead of V).	1 = 0.001 mA
01.40	DI7-12 STATUS	Status of digital inputs DI7 to DI12 read from the digital I/O extension modules (optional). E.g. value 000001: DI7 is on, DI8 to DI12 are off.	1 = 1
01.41	EXT RO STATUS	Status of the relay outputs on the digital I/O extension modules (optional). E.g. value 0000001: RO1 of module 1 is energised. Other relay outputs are de-energised.	1 = 1
01.42	PROCESS SPEED REL	Motor actual speed in percent of the Absolute Maximum Speed. If parameter 99.04 is SCALAR, the value is the relative actual output frequency.	1 = 1
01.43	MOTOR RUN TIME	Motor run time counter. The counter runs when the inverter modulates. Can be reset by parameter 34.06 .	1 = 10 h
01.44	FAN ON-TIME	Running time of the drive cooling fan. Note: Resetting of the counter is recommended when the fan is replaced. For more information, contact your local ABB representative.	1 = 10 h
01.45	CTRL BOARD TEMP	Control board temperature.	1 = 1°C
01.46	SAVED KWH	Energy saved in kWh compared to direct-on-line motor connection. See parameter group 45 ENERGY OPT on page 164 .	1 = 100 kWh
01.47	SAVED GWH	Energy saved in GWh compared to direct-on-line motor connection.	1 = 1 GWh



No.	Name/Value	Description	FbEq
01.48	SAVED AMOUNT	Monetary savings compared to direct-on-line motor connection. This value is a multiplication of parameters 01.46 SAVED KWH and 45.02 ENERGY TARIFF1 . See parameter group 45 ENERGY OPT on page 164 .	1 = 100 cur
01.49	SAVED AMOUNT M	Monetary savings in millions compared to direct-on-line motor connection.	1 = 1 Mcur
01.50	SAVED CO2	Reduction in CO ₂ emissions in kilograms compared to direct-on-line motor connection. This value is calculated by multiplying saved energy in megawatt-hours by 500 kg/MWh. See parameter group 45 ENERGY OPT on page 164 .	1 = 100 kg
01.51	SAVED CO2 KTON	Reduction in CO ₂ emissions in kilotons compared to direct-on-line motor connection.	1 = 1 kton
02 ACTUAL SIGNALS		Speed and torque reference monitoring signals.	
02.01	SPEED REF 2	Limited speed reference. 100% corresponds to the Absolute Maximum Speed of the motor.	0 = 0% 20000 = 100% of motor absolute max. speed
02.02	SPEED REF 3	Ramped and shaped speed reference. 100% corresponds to the Absolute Maximum Speed of the motor.	20000 = 100%
02.09	TORQUE REF 2	Speed controller output. 100% corresponds to the motor nominal torque.	0 = 0% 10000 = 100% of motor nominal torque
02.10	TORQUE REF 3	Torque reference. 100% corresponds to the motor nominal torque.	10000 = 100%
02.13	TORQ USED REF	Torque reference after frequency, voltage and torque limiters. 100% corresponds to the motor nominal torque.	10000 = 100%
02.14	FLUX REF	Flux reference in percent.	10000 = 100%
02.17	SPEED ESTIMATED	Estimated motor speed. 100% corresponds to the Absolute Maximum Speed of the motor.	20000 = 100%
02.18	SPEED MEASURED	Measured motor actual speed (zero when no encoder is used). 100% corresponds to the Absolute Maximum Speed of the motor.	20000 = 100%
02.19	MOTOR ACCELERATIO	Calculated motor acceleration from signal 01.02 MOTOR SPEED .	1=1 rpm/s.
02.20	USER CURRENT	Measured motor current in percent of the user load curve current. User load curve current is defined by parameters 72.02...72.09 . See section User load curve on page 83 .	10 = 1%
03 ACTUAL SIGNALS		Data words for monitoring of fieldbus communication (each signal is a 16-bit data word).	2)
03.01	MAIN CTRL WORD	A 16-bit data word. See section 03.01 MAIN CONTROL WORD on page 211 .	
03.02	MAIN STATUS WORD	A 16-bit data word. See section 03.02 MAIN STATUS WORD on page 212 .	
03.03	AUX STATUS WORD	A 16-bit data word. See section 03.03 AUXILIARY STATUS WORD on page 219 .	
03.04	LIMIT WORD 1	A 16-bit data word. See section 03.04 LIMIT WORD 1 on page 220 .	
03.05	FAULT WORD 1	A 16-bit data word. See section 03.05 FAULT WORD 1 on page 220 .	
03.06	FAULT WORD 2	A 16-bit data word. See section 03.06 FAULT WORD 2 on page 221 .	

No.	Name/Value	Description	FbEq
03.07	SYSTEM FAULT	A 16-bit data word. See section 03.07 SYSTEM FAULT WORD on page 222 .	
03.08	ALARM WORD 1	A 16-bit data word. See section 03.08 ALARM WORD 1 on page 222 .	
03.09	ALARM WORD 2	A 16-bit data word. See section 03.09 ALARM WORD 2 on page 223 .	
03.11	FOLLOWER MCW	A 16-bit data word. For the contents, see <i>Master/Follower Application Guide</i> [3AFE64590430 (English)].	
03.13	AUX STATUS WORD 3	A 16-bit data word. See section 03.13 AUXILIARY STATUS WORD 3 on page 223 .	
03.14	AUX STATUS WORD 4	A 16-bit data word. See section 03.14 AUXILIARY STATUS WORD 4 on page 224 .	
03.15	FAULT WORD 4	A 16-bit data word. See section 03.15 FAULT WORD 4 on page 224 .	
03.16	ALARM WORD 4	A 16-bit data word. See section 03.16 ALARM WORD 4 on page 225 .	
03.17	FAULT WORD 5	A 16-bit data word. See section 03.17 FAULT WORD 5 on page 225 .	
03.18	ALARM WORD 5	A 16-bit data word. See section 03.18 ALARM WORD 5 on page 226 .	
03.19	INT INIT FAULT	A 16-bit data word. See section 03.19 INT INIT FAULT on page 226 .	
03.20	LATEST FAULT	Fieldbus code of the latest fault. See chapter Fault tracing for the codes.	
03.21	2.LATEST FAULT	Fieldbus code of the 2nd latest fault.	
03.22	3.LATEST FAULT	Fieldbus code of the 3rd latest fault.	
03.23	4.LATEST FAULT	Fieldbus code of the 4th latest fault.	
03.24	5.LATEST FAULT	Fieldbus code of the 5th latest fault.	
03.25	LATEST WARNING	Fieldbus code of the latest warning.	
03.26	2.LATEST WARNING	Fieldbus code of the 2nd latest warning.	
03.27	3.LATEST WARNING	Fieldbus code of the 3rd latest warning.	
03.28	4.LATEST WARNING	Fieldbus code of the 4th latest warning.	
03.29	5.LATEST WARNING	Fieldbus code of the 5th latest warning.	
03.30	LIMIT WORD INV	A 16-bit data word. See section 03.30 LIMIT WORD INV on page 227 .	
03.31	ALARM WORD 6	A 16-bit data word. See section 03.31 ALARM WORD 6 on page 227 .	
03.32	EXT IO STATUS	Status of emergency stop and step up modules. See section 03.32 EXT IO STATUS on page 228 .	
03.33	FAULT WORD 6	A 16-bit data word. See section 03.33 FAULT WORD 6 on page 228 .	
04 ACTUAL SIGNALS		Signals for parallel connected inverters	2)
04.01	FAULTED INT INFO	A 16-bit data word. See section 04.01 FAULTED INT INFO on page 229 .	
04.02	INT SC INFO	A 16-bit data word. See section 04.02 INT SC INFO on page 230 .	
09 ACTUAL SIGNALS		Signals for the Adaptive Program	
09.01	AI1 SCALED	Value of analogue input AI1 scaled to an integer value.	20000 = 10 V
09.02	AI2 SCALED	Value of analogue input AI2 scaled to an integer value.	20000 = 20 mA
09.03	AI3 SCALED	Value of analogue input AI3 scaled to an integer value.	20000 = 20 mA
09.04	AI5 SCALED	Value of analogue input AI5 scaled to an integer value.	20000 = 20 mA
09.05	AI6 SCALED	Value of analogue input AI6 scaled to an integer value.	20000 = 20 mA

No.	Name/Value	Description	FbEq
09.06	DS MCW	Control Word (CW) of the Main Reference data set received from the master station through the fieldbus interface	0 ... 65535 (Decimal)
09.07	MASTER REF1	Reference 1 (REF1) of the Main Reference data set received from the master station through the fieldbus interface	-32768 ... 32767
09.08	MASTER REF2	Reference 2 (REF2) of the Main Reference data set received from the master station through the fieldbus interface	-32768 ... 32767
09.09	AUX DS VAL1	Auxiliary data set value 1 received from the master station through the fieldbus interface	-32768 ... 32767
09.10	AUX DS VAL2	Auxiliary data set value 2 received from the master station through the fieldbus interface	-32768 ... 32767
09.11	AUX DS VAL3	Auxiliary data set value 3 received from the master station through the fieldbus interface	-32768 ... 32767
09.12	LCU ACT SIGNAL1	Line-side converter signal selected by parameter 95.08 . A 16-bit data word.	
09.13	LCU ACT SIGNAL2	Line-side converter signal selected by parameter 95.09 . A 16-bit data word.	

1) Percent of motor maximum speed / nominal torque / maximum process reference (depending on the ACS800 macro selected).

2) The contents of these data words are detailed in chapter [Fieldbus control](#).

Index	Name/Selection	Description	FbEq															
10	START/STOP/DIR	The sources for external start, stop and direction control																
10.01	EXT1 STRT/STP/DIR	Defines the connections and the source of the start, stop and direction commands for external control location 1 (EXT1).																
	NOT SEL	No start, stop and direction command source.	1															
	DI1	Start and stop through digital input DI1. 0 = stop; 1 = start. Direction is fixed according to parameter 10.3 DIRECTION.  WARNING! After a fault reset, the drive will start if the start signal is on.	2															
	DI1,2	Start and stop through digital input DI1. 0 = stop, 1 = start. Direction through digital input DI2. 0 = forward, 1 = reverse. To control direction, parameter 10.03 DIRECTION must be REQUEST.  WARNING! After a fault reset, the drive will start if the start signal is on.	3															
	DI1P,2P	Pulse start through digital input DI1. 0 -> 1: Start. Pulse stop through digital input DI2. 1 -> 0: Stop. Direction of rotation is fixed according to parameter 10.03 DIRECTION.	4															
	DI1P,2P,3	Pulse start through digital input DI1. 0 -> 1: Start. Pulse stop through digital input DI2. 1 -> 0: Stop. Direction through digital input DI3. 0 = forward, 1 = reverse. To control direction, parameter 10.03 DIRECTION must be REQUEST.	5															
	DI1P,2P,3P	Pulse start forward through digital input DI1. 0 -> 1: Start forward. Pulse start reverse through digital input DI2. 0 -> 1: Start reverse. Pulse stop through digital input DI3. 1 -> "0": stop. To control the direction, parameter 10.03 DIRECTION must be REQUEST.	6															
	DI6	See selection DI1.	7															
	DI6,5	See selection DI1,2. DI6: Start/stop, DI5: direction.	8															
	KEYPAD	Control panel. To control the direction, parameter 10.03 DIRECTION must be REQUEST.	9															
	COMM.CW	Fieldbus Control Word.	10															
	DI7	See selection DI1.	11															
	DI7,8	See selection DI1,2. DI7: start/stop, DI8: direction.	12															
	DI7P,8P	See selection DI1P,2P.	13															
	DI7P,8P,9	See selection DI1P,2P,3.	14															
	DI7P,8P,9P	See selection DI1P,2P,3P.	15															
	PARAM 10.04	Source selected by 10.04.	16															
	DI1 F, DI2 R	Start, stop and direction commands through digital inputs DI1 and DI2. <table border="1" data-bbox="539 1659 1217 1809"> <thead> <tr> <th>DI1</th> <th>DI2</th> <th>Operation</th> </tr> </thead> <tbody> <tr> <td>0</td> <td>0</td> <td>Stop</td> </tr> <tr> <td>1</td> <td>0</td> <td>Start forward</td> </tr> <tr> <td>0</td> <td>1</td> <td>Start reverse</td> </tr> <tr> <td>1</td> <td>1</td> <td>Stop</td> </tr> </tbody> </table> <p>Note: Parameter 10.03 DIRECTION must be REQUEST.</p>	DI1	DI2	Operation	0	0	Stop	1	0	Start forward	0	1	Start reverse	1	1	Stop	17
DI1	DI2	Operation																
0	0	Stop																
1	0	Start forward																
0	1	Start reverse																
1	1	Stop																
10.02	EXT2 STRT/STP/DIR	Defines the connections and the source of the start, stop and direction commands for external control location 2 (EXT2).																
	NOT SEL	See parameter 10.01.	1															

Index	Name/Selection	Description	FbEq
	DI1	See parameter 10.01.	2
	DI1,2	See parameter 10.01.	3
	DI1P,2P	See parameter 10.01.	4
	DI1P,2P,3	See parameter 10.01.	5
	DI1P,2P,3P	See parameter 10.01.	6
	DI6	See parameter 10.01.	7
	DI6,5	See parameter 10.01.	8
	KEYPAD	See parameter 10.01.	9
	COMM.CW	See parameter 10.01.	10
	DI7	See parameter 10.01.	11
	DI7,8	See parameter 10.01.	12
	DI7P,8P	See parameter 10.01.	13
	DI7P,8P,9	See parameter 10.01.	14
	DI7P,8P,9P	See parameter 10.01.	15
	PARAM 10.05	Source selected by 10.05.	16
	DI1 F, DI2 R	See parameter 10.01.	17
10.03	REF DIRECTION	Enables the control of rotation direction of the motor, or fixes the direction.	
	FORWARD	Fixed to forward	1
	REVERSE	Fixed to reverse	2
	REQUEST	Direction of rotation control allowed	3
10.04	EXT 1 STRT PTR	Defines the source or constant for value PAR 10.04 of parameter 10.01.	
	-255.255.31 ... +255.255.31 / C.- 32768 ... C.32767	Parameter index or a constant value: - Parameter pointer: Inversion, group, index and bit fields. The bit number is effective only for blocks handling boolean inputs. - Constant value: Inversion and constant fields. Inversion field must have value C to enable the constant setting.	-
10.05	EXT 2 STRT PTR	Defines the source or constant for value PAR 10.05 of parameter 10.02.	
	-255.255.31 ... +255.255.31 / C.- 32768 ... C.32767	Parameter index or a constant value. See parameter 10.04 for information on the difference.	-
10.06	JOG SPEED SELECT	Defines the signal that activates jogging function. The operation of the jogging is explained in section <i>Jogging</i> on page 81.	
	NOT SEL	Not selected.	1
	DI3	Digital input DI3. 0 = Jogging is inactive. 1 = Jogging is active.	2
	DI4	See selection DI3.	3
	DI5	See selection DI3.	4
	DI6	See selection DI3.	5
	DI7	See selection DI3.	6
	DI8	See selection DI3.	7
	DI9	See selection DI3.	8
	DI10	See selection DI3.	9
	DI11	See selection DI3.	10
	DI12	See selection DI3.	11

Index	Name/Selection	Description	FbEq
10.07	NET CONTROL	When active, fieldbus overrides the selection of parameter 10.01. Fieldbus Control Word (except bit 11) is enabled when EXT1 is selected as the active control location. Note: Only visible with the Generic Drive communication profile selected (98.07). Note: The setting is not saved in the permanent memory (will reset to zero when power is switched off).	
	0	Inactive	0
	1	Active	1
10.08	NET REFERENCE	When active, fieldbus overrides the selection of parameter 11.03. Fieldbus reference REF1 is enabled when EXT1 is selected as the active control location. Note: Only visible with the Generic Drive communication profile selected (98.07). Note: The setting is not saved in the permanent memory (will reset to zero when power is switched off).	
	0	Inactive	0
	1	Active	1
10.09	SLS ACTIVE	Selects the source for the SLS (safely-limited speed) command. Note: This parameter is available in AS7R firmware version only.	
	NO	No DI selected for the SLS function.	1
	DI1	The SLS function is activated by a falling edge of DI1, i.e. when the value of DI1 becomes 0.	2
	DI2	See selection DI1.	3
	DI3	See selection DI1.	4
	DI4	See selection DI1.	5
	DI5	See selection DI1.	6
	DI6	See selection DI1.	7
	DI7	See selection DI1.	8
	DI8	See selection DI1.	9
	DI9	See selection DI1.	10
	DI10	See selection DI1.	11
	DI11	See selection DI1.	12
	DI12	See selection DI1.	13
11 REFERENCE SELECT		Panel reference type, external control location selection and external reference sources and limits	
11.01	KEYPAD REF SEL	Selects the type of the reference given from panel.	
	REF1 (rpm)	Speed reference in rpm. (Frequency reference (Hz) if parameter 99.04 is SCALAR.)	1
	REF2 (%)	%-reference. The use of REF2 vary depending on the application macro. For example, if the Torque Control macro is selected, REF2 is the torque reference.	2
11.02	EXT1/EXT2 SELECT	Defines the source from which the drive reads the signal that selects between the two external control locations, EXT1 or EXT2.	
	DI1	Digital input DI1. 0 = EXT1, 1 = EXT2.	1
	DI2	See selection DI1.	2

Index	Name/Selection	Description	FbEq
	DI3	See selection DI1.	3
	DI4	See selection DI1.	4
	DI5	See selection DI1.	5
	DI6	See selection DI1.	6
	EXT1	EXT1 active. The control signal sources are defined by parameter 10.01 and 11.03.	7
	EXT2	EXT2 active. The control signal sources are defined by parameter 10.02 and 11.06.	8
	COMM.CW	Fieldbus Control Word, bit 11.	9
	DI7	See selection DI1.	10
	DI8	See selection DI1.	11
	DI9	See selection DI1.	12
	DI10	See selection DI1.	13
	DI11	See selection DI1.	14
	DI12	See selection DI1.	15
	PARAM 11.09	Source selected by parameter 11.09.	16
11.03	EXT REF1 SELECT	Selects the signal source for external reference REF1	
	KEYPAD	Control panel. The first line on the display shows the reference value.	1
	AI1	Analogue input AI1. Note: If the signal is bipolar (± 10 VDC), use the selection AI1 BIPOLAR. (The selection AI1 ignores the negative signal range.)	2
	AI2	Analogue input AI2.	3
	AI3	Analogue input AI3.	4

Index	Name/Selection	Description	FbEq
	AI1/JOYST	<p>Unipolar analogue input AI1 as joystick. The minimum input signal runs the motor at the maximum reference in the reverse direction, the maximum input at the maximum reference in the forward direction.</p> <p>Note: Parameter 10.03 must have the value REQUEST.</p> <p>WARNING! Minimum reference for joystick must be higher than 0.5 V. Set parameter 13.01 to 2 V or to a value higher than 0.5 V and analogue signal loss detection parameter 30.01 to FAULT. The drive will stop in case the control signal is lost.</p> <p>Speed Reference (REF1)</p> <p>Par. 13.01 = 2 V, Par 13.02 = 10 V</p> <p>Note: If the signal is bipolar (± 10 VDC), use the selection AI1 BIPOLAR. The selection AI1/JOYST ignores the negative signal range.</p>	5
	AI2/JOYST	See selection AI1/JOYST.	6
	AI1+AI3	Summation of analogue input AI1 and AI3	7
	AI2+AI3	Summation of analogue input AI2 and AI3	8
	AI1-AI3	Subtraction of analogue input AI1 and AI3	9
	AI2-AI3	Subtraction of analogue input AI2 and AI3	10
	AI1*AI3	Multiplication of analogue input AI1 and AI3	11
	AI2*AI3	Multiplication of analogue input AI2 and AI3	12
	MIN(AI1,AI3)	Minimum of analogue input AI1 and AI3	13
	MIN(AI2,AI3)	Minimum of analogue input AI2 and AI3	14
	MAX(AI1,AI3)	Maximum of analogue input AI1 and AI3	15
	MAX(AI2,AI3)	Maximum of analogue input AI2 and AI3	16
	DI3U,4D(R)	Digital input 3: Reference increase. Digital input DI4: Reference decrease. Stop command or power switch off resets the reference to zero. Parameter 22.04 defines the rate of the reference change.	17
	DI3U,4D	Digital input 3: Reference increase. Digital input DI4: Reference decrease. The program stores the active speed reference (not reset by a stop command or power switch-off). Parameter 22.04 defines the rate of the reference change.	18
	DI5U,6D	See selection DI3U,4D.	19
	COMM. REF	Fieldbus reference REF1	20
	COM.REF1+AI1	Summation of fieldbus reference REF1 and analogue input AI1	21
	COM.REF1*AI1	Multiplication of fieldbus reference REF1 and analogue input AI1	22

Index	Name/Selection	Description	FbEq
	FAST COMM	<p>As with the selection COMM. REF, except the following differences:</p> <ul style="list-style-type: none"> - shorter communication cycle time when transferring the reference to the core motor control program (6 ms -> 2 ms) - the direction cannot be controlled through interfaces defined by parameters 10.01 or 10.02, nor with the control panel - parameter group 25 CRITICAL SPEEDS is not effective <p>Note: If any of the following selections is true, the selection is not effective. Instead, the operation is according to COMM. REF.</p> <ul style="list-style-type: none"> - parameter 99.02 is PID - parameter 99.04 is SCALAR - parameter 40.14 has value PROPORTIONAL or DIRECT 	23
	COM.REF1+AI5	See selection COM.REF1+AI1 (AI5 used instead of AI1).	24
	COM.REF1*AI5	See selection COM.REF1*AI1 (AI5 used instead of AI1).	25
	AI5	Analogue input AI5	26
	AI6	Analogue input AI6	27
	AI5/JOYST	See selection AI1/JOYST.	28
	AI6/JOYST	See selection AI1/JOYST.	29
	AI5+AI6	Summation of analogue input AI5 and AI6.	30
	AI5-AI6	Subtraction of analogue input AI5 and AI6.	31
	AI5*AI6	Multiplication of analogue input AI5 and AI6.	32
	MIN(AI5,AI6)	Lower of analogue input AI5 and AI6.	33
	MAX(AI5,AI6)	Higher of analogue input AI5 and AI6.	34
	DI11U,12D(R)	See selection DI3U,4D(R).	35
	DI11U,12D	See selection DI3U,4D.	36
	PARAM 11.10	Source selected by 11.10 .	37

Index	Name/Selection	Description	FbEq								
	AI1 BIPOLAR	<p>Bipolar analogue input AI1 (-10 ... 10 V). The figure below illustrates the use of the input as the speed reference.</p> <p>Operation Range</p> <p>10.03 DIRECTION = FORWARD or REQUEST</p> <p>10.03 DIRECTION = REVERSE or REQUEST</p> <p>minAI1 = 13.01 MINIMUM AI1 maxAI1 = 13.02 MAXIMUM AI1 scaled maxREF1 = 13.03 SCALE AI1 x 11.05 EXT REF1 MAXIMUM minREF1 = 11.04 EXT REF1 MINIMUM</p>	38								
11.04	EXT REF1 MINIMUM	<p>Defines the minimum value for external reference REF1 (absolute value). Corresponds to the minimum setting of the source signal used.</p>									
	0 ... 18000 rpm	<p>Setting range in rpm. (Hz if parameter 99.04 is SCALAR.)</p> <p>Example: Analogue input AI1 is selected as the reference source (value of parameter 11.03 is AI1). The reference minimum and maximum correspond the AI minimum and maximum settings as follows:</p> <p><i>EXT REF1 Range</i></p> <table border="1"> <tr> <td>1</td> <td>parameter 13.01</td> </tr> <tr> <td>2</td> <td>parameter 13.02</td> </tr> <tr> <td>1'</td> <td>parameter 11.04</td> </tr> <tr> <td>2'</td> <td>parameter 11.05</td> </tr> </table> <p>Note: If the reference is given through fieldbus, the scaling differs from that of an analogue signal. See chapter <i>Fieldbus control</i> for more information.</p>	1	parameter 13.01	2	parameter 13.02	1'	parameter 11.04	2'	parameter 11.05	1 ... 18000
1	parameter 13.01										
2	parameter 13.02										
1'	parameter 11.04										
2'	parameter 11.05										

Index	Name/Selection	Description	FbEq
11.05	EXT REF1 MAXIMUM	Defines the maximum value for external reference REF1 (absolute value). Corresponds to the maximum setting of the used source signal.	
	0 ... 18000 rpm	Setting range. (Hz if value of parameter 99.04 is SCALAR.) See parameter 11.04.	1 ... 18000
11.06	EXT REF2 SELECT	Selects the signal source for external reference REF2. REF2 is a - speed reference in percent of the Absolute Maximum Speed if parameter 99.02 = FACTORY, HAND/AUTO or SEQ CTRL. - torque reference in percent of the motor nominal torque if parameter 99.02 = TORQUE. - process reference in percent of the maximum process quantity if parameter 99.02 = PID CTRL. - frequency reference in percent of the Absolute Maximum Frequency if parameter 99.04 = SCALAR.	
	KEYPAD	See parameter 11.03.	1
	AI1	See parameter 11.03. Note: If the signal is bipolar (± 10 VDC), use the selection AI1 BIPOLAR. The selection AI1 ignores the negative signal range.	2
	AI2	See parameter 11.03.	3
	AI3	See parameter 11.03.	4
	AI1/JOYST	See parameter 11.03.	5
	AI2/JOYST	See parameter 11.03.	6
	AI1+AI3	See parameter 11.03.	7
	AI2+AI3	See parameter 11.03.	8
	AI1-AI3	See parameter 11.03.	9
	AI2-AI3	See parameter 11.03.	10
	AI1*AI3	See parameter 11.03.	11
	AI2*AI3	See parameter 11.03.	12
	MIN(AI1,AI3)	See parameter 11.03.	13
	MIN(AI2,AI3)	See parameter 11.03.	14
	MAX(AI1,AI3)	See parameter 11.03.	15
	MAX(AI2,AI3)	See parameter 11.03.	16
	DI3U,4D(R)	See parameter 11.03.	17
	DI3U,4D	See parameter 11.03.	18
	DI5U,6D	See parameter 11.03.	19
	COMM. REF	See parameter 11.03.	20
	COM.REF2+AI1	See parameter 11.03.	21
	COM.REF2*AI1	See parameter 11.03.	22
	FAST COMM	See parameter 11.03.	23
	COM.REF2+AI5	See parameter 11.03.	24
	COM.REF2*AI5	See parameter 11.03.	25
	AI5	See parameter 11.03.	26
	AI6	See parameter 11.03.	27
	AI5/JOYST	See parameter 11.03.	28
	AI6/JOYST	See parameter 11.03.	29

Index	Name/Selection	Description	FbEq
	AI5+AI6	See parameter 11.03.	30
	AI5-AI6	See parameter 11.03.	31
	AI5*AI6	See parameter 11.03.	32
	MIN(AI5,AI6)	See parameter 11.03.	33
	MAX(AI5,AI6)	See parameter 11.03.	34
	DI11U,12D(R)	See parameter 11.03.	35
	DI11U,12D	See parameter 11.03.	36
	PARAM 11.11	Source selected by 11.11.	37
	AI1 BIPOLAR	See parameter 11.03.	38
11.07	EXT REF2 MINIMUM	Defines the minimum value for external reference REF2 (absolute value). Corresponds to the minimum setting of the source signal used.	
	0 ... 100%	Setting range in percent. Correspondence to the source signal limits: - Source is an analogue input: See example for parameter 11.04. - Source is a serial link: See chapter <i>Fieldbus control</i> .	0 ... 10000
11.08	EXT REF2 MAXIMUM	Defines the maximum value for external reference REF2 (absolute value). Corresponds to the maximum setting of the source signal used.	
	0 ... 600%	Setting range. Correspondence to the source signal limits: - Source is an analogue input: See parameter 11.04. - Source is a serial link: See chapter <i>Fieldbus control</i> .	0 ... 6000
11.09	EXT 1/2 SEL PTR	Defines the source or constant for value PAR 11.09 of parameter 11.02.	
	-255.255.31 ... +255.255.31 / C.- 32768 ... C.32767	Parameter index or a constant value. See parameter 10.04 for information on the difference.	-
11.10	EXT 1 REF PTR	Defines the source or constant for value PAR 11.10 of parameter 11.03.	
	-255.255.31 ... +255.255.31 / C.- 32768 ... C.32767	Parameter index or a constant value. See parameter 10.04 for information on the difference.	-
11.11	EXT 2 REF PTR	Defines the source or constant for value PAR 11.11 of parameter 11.06.	
	-255.255.31 ... +255.255.31 / C.- 32768 ... C.32767	Parameter index or a constant value. See parameter 10.04 for information on the difference.	-
12 CONSTANT SPEEDS		Constant speed selection and values. An active constant speed overrides the drive speed reference. See section <i>Constant speeds</i> on page 59. Note: If parameter 99.04 is SCALAR, only speeds 1 to 5 and speed 15 are in use.	
12.01	CONST SPEED SEL	Activates the constant speeds or selects the activation signal.	
	NOT SEL	No constant speeds in use	1
	DI1(SPEED1)	Speed defined by parameter 12.02 is activated through digital input DI1. 1 = active, 0 = inactive.	2
	DI2(SPEED2)	Speed defined by parameter 12.03 is activated through digital input DI2. 1 = active, 0 = inactive.	3
	DI3(SPEED3)	Speed defined by parameter 12.04 is activated through digital input DI3. 1 = active, 0 = inactive.	4
	DI4(SPEED4)	Speed defined by parameter 12.05 is activated through digital input DI4. 1 = active, 0 = inactive.	5

Index	Name/Selection	Description	FbEq																																																																																					
	DI5(SPEED5)	Speed defined by parameter 12.06 is activated through digital input DI5. 1 = active, 0 = inactive.	6																																																																																					
	DI6(SPEED6)	Speed defined by parameter 12.07 is activated through digital input DI6. 1 = active, 0 = inactive.	7																																																																																					
	DI1,2	Constant speed selection through digital input DI1 and DI2. <table border="1" style="margin-left: 20px;"> <thead> <tr> <th>DI1</th> <th>DI2</th> <th>Constant speed in use</th> </tr> </thead> <tbody> <tr> <td>0</td> <td>0</td> <td>No constant speed</td> </tr> <tr> <td>1</td> <td>0</td> <td>Speed defined by parameter 12.02</td> </tr> <tr> <td>0</td> <td>1</td> <td>Speed defined by parameter 12.03</td> </tr> <tr> <td>1</td> <td>1</td> <td>Speed defined by parameter 12.04</td> </tr> </tbody> </table>	DI1	DI2	Constant speed in use	0	0	No constant speed	1	0	Speed defined by parameter 12.02	0	1	Speed defined by parameter 12.03	1	1	Speed defined by parameter 12.04	8																																																																						
DI1	DI2	Constant speed in use																																																																																						
0	0	No constant speed																																																																																						
1	0	Speed defined by parameter 12.02																																																																																						
0	1	Speed defined by parameter 12.03																																																																																						
1	1	Speed defined by parameter 12.04																																																																																						
	DI3,4	See selection DI1,2.	9																																																																																					
	DI5,6	See selection DI1,2.	10																																																																																					
	DI1,2,3	Constant speed selection through digital input DI1, DI2 and DI3. <table border="1" style="margin-left: 20px;"> <thead> <tr> <th>DI1</th> <th>DI2</th> <th>DI3</th> <th>Constant speed in use</th> </tr> </thead> <tbody> <tr> <td>0</td> <td>0</td> <td>0</td> <td>No constant speed</td> </tr> <tr> <td>1</td> <td>0</td> <td>0</td> <td>Speed defined by parameter 12.02</td> </tr> <tr> <td>0</td> <td>1</td> <td>0</td> <td>Speed defined by parameter 12.03</td> </tr> <tr> <td>1</td> <td>1</td> <td>0</td> <td>Speed defined by parameter 12.04</td> </tr> <tr> <td>0</td> <td>0</td> <td>1</td> <td>Speed defined by parameter 12.05</td> </tr> <tr> <td>1</td> <td>0</td> <td>1</td> <td>Speed defined by parameter 12.06</td> </tr> <tr> <td>0</td> <td>1</td> <td>1</td> <td>Speed defined by parameter 12.07</td> </tr> <tr> <td>1</td> <td>1</td> <td>1</td> <td>Speed defined by parameter 12.08</td> </tr> </tbody> </table>	DI1	DI2	DI3	Constant speed in use	0	0	0	No constant speed	1	0	0	Speed defined by parameter 12.02	0	1	0	Speed defined by parameter 12.03	1	1	0	Speed defined by parameter 12.04	0	0	1	Speed defined by parameter 12.05	1	0	1	Speed defined by parameter 12.06	0	1	1	Speed defined by parameter 12.07	1	1	1	Speed defined by parameter 12.08	11																																																	
DI1	DI2	DI3	Constant speed in use																																																																																					
0	0	0	No constant speed																																																																																					
1	0	0	Speed defined by parameter 12.02																																																																																					
0	1	0	Speed defined by parameter 12.03																																																																																					
1	1	0	Speed defined by parameter 12.04																																																																																					
0	0	1	Speed defined by parameter 12.05																																																																																					
1	0	1	Speed defined by parameter 12.06																																																																																					
0	1	1	Speed defined by parameter 12.07																																																																																					
1	1	1	Speed defined by parameter 12.08																																																																																					
	DI3,4,5	See selection DI1,2,3.	12																																																																																					
	DI4,5,6	See selection DI1,2,3.	13																																																																																					
	DI3,4,5,6	Constant speed selection through digital input DI3, 4, 5 and 6 <table border="1" style="margin-left: 20px;"> <thead> <tr> <th>DI1</th> <th>DI2</th> <th>DI3</th> <th>DI4</th> <th>Constant speed in use</th> </tr> </thead> <tbody> <tr> <td>0</td> <td>0</td> <td>0</td> <td>0</td> <td>No constant speed</td> </tr> <tr> <td>1</td> <td>0</td> <td>0</td> <td>0</td> <td>Speed defined by parameter 12.02</td> </tr> <tr> <td>0</td> <td>1</td> <td>0</td> <td>0</td> <td>Speed defined by parameter 12.03</td> </tr> <tr> <td>1</td> <td>1</td> <td>0</td> <td>0</td> <td>Speed defined by parameter 12.04</td> </tr> <tr> <td>0</td> <td>0</td> <td>1</td> <td>0</td> <td>Speed defined by parameter 12.05</td> </tr> <tr> <td>1</td> <td>0</td> <td>1</td> <td>0</td> <td>Speed defined by parameter 12.06</td> </tr> <tr> <td>0</td> <td>1</td> <td>1</td> <td>0</td> <td>Speed defined by parameter 12.07</td> </tr> <tr> <td>1</td> <td>1</td> <td>1</td> <td>0</td> <td>Speed defined by parameter 12.08</td> </tr> <tr> <td>0</td> <td>0</td> <td>0</td> <td>1</td> <td>Speed defined by parameter 12.09</td> </tr> <tr> <td>1</td> <td>0</td> <td>0</td> <td>1</td> <td>Speed defined by parameter 12.10</td> </tr> <tr> <td>0</td> <td>1</td> <td>0</td> <td>1</td> <td>Speed defined by parameter 12.11</td> </tr> <tr> <td>1</td> <td>1</td> <td>0</td> <td>1</td> <td>Speed defined by parameter 12.12</td> </tr> <tr> <td>0</td> <td>0</td> <td>1</td> <td>1</td> <td>Speed defined by parameter 12.13</td> </tr> <tr> <td>1</td> <td>0</td> <td>1</td> <td>1</td> <td>Speed defined by parameter 12.14</td> </tr> <tr> <td>0</td> <td>1</td> <td>1</td> <td>1</td> <td>Speed defined by parameter 12.15</td> </tr> <tr> <td>1</td> <td>1</td> <td>1</td> <td>1</td> <td>Speed defined by parameter 12.16</td> </tr> </tbody> </table>	DI1	DI2	DI3	DI4	Constant speed in use	0	0	0	0	No constant speed	1	0	0	0	Speed defined by parameter 12.02	0	1	0	0	Speed defined by parameter 12.03	1	1	0	0	Speed defined by parameter 12.04	0	0	1	0	Speed defined by parameter 12.05	1	0	1	0	Speed defined by parameter 12.06	0	1	1	0	Speed defined by parameter 12.07	1	1	1	0	Speed defined by parameter 12.08	0	0	0	1	Speed defined by parameter 12.09	1	0	0	1	Speed defined by parameter 12.10	0	1	0	1	Speed defined by parameter 12.11	1	1	0	1	Speed defined by parameter 12.12	0	0	1	1	Speed defined by parameter 12.13	1	0	1	1	Speed defined by parameter 12.14	0	1	1	1	Speed defined by parameter 12.15	1	1	1	1	Speed defined by parameter 12.16	14
DI1	DI2	DI3	DI4	Constant speed in use																																																																																				
0	0	0	0	No constant speed																																																																																				
1	0	0	0	Speed defined by parameter 12.02																																																																																				
0	1	0	0	Speed defined by parameter 12.03																																																																																				
1	1	0	0	Speed defined by parameter 12.04																																																																																				
0	0	1	0	Speed defined by parameter 12.05																																																																																				
1	0	1	0	Speed defined by parameter 12.06																																																																																				
0	1	1	0	Speed defined by parameter 12.07																																																																																				
1	1	1	0	Speed defined by parameter 12.08																																																																																				
0	0	0	1	Speed defined by parameter 12.09																																																																																				
1	0	0	1	Speed defined by parameter 12.10																																																																																				
0	1	0	1	Speed defined by parameter 12.11																																																																																				
1	1	0	1	Speed defined by parameter 12.12																																																																																				
0	0	1	1	Speed defined by parameter 12.13																																																																																				
1	0	1	1	Speed defined by parameter 12.14																																																																																				
0	1	1	1	Speed defined by parameter 12.15																																																																																				
1	1	1	1	Speed defined by parameter 12.16																																																																																				
	DI7(SPEED1)	Speed defined by parameter 12.02 is activated through digital input DI7. 1 = active, 0 = inactive.	15																																																																																					
	DI8(SPEED2)	Speed defined by parameter 12.03 is activated through digital input DI8. 1 = active, 0 = inactive.	16																																																																																					

Index	Name/Selection	Description	FbEq
	DI9(SPEED3)	Speed defined by parameter 12.04 is activated through digital input DI9. 1 = active, 0 = inactive.	17
	DI10(SPEED4)	Speed defined by parameter 12.05 is activated through digital input DI10. 1 = active, 0 = inactive.	18
	DI11(SPEED5)	Speed defined by parameter 12.06 is activated through digital input DI11. 1 = active, 0 = inactive.	19
	DI12 (SPEED6)	Speed defined by parameter 12.07 is activated through digital input DI12. 1 = active, 0 = inactive.	20
	DI7,8	See selection DI1,2.	21
	DI9,10	See selection DI1,2.	22
	DI11,12	See selection DI1,2.	23
12.02	CONST SPEED 1	Defines speed 1. An absolute value. Does not include the direction information.	
	0 ... 18000 rpm	Setting range	0 ... 18000
12.03	CONST SPEED 2	Defines speed 2. An absolute value. Does not include the direction information.	
	0 ... 18000 rpm	Setting range	0 ... 18000
12.04	CONST SPEED 3	Defines speed 3. An absolute value. Does not include the direction information.	
	0 ... 18000 rpm	Setting range	0 ... 18000
12.05	CONST SPEED 4	Defines speed 4. An absolute value. Does not include the direction information.	
	0 ... 18000 rpm	Setting range	0 ... 18000
12.06	CONST SPEED 5	Defines speed 5. An absolute value. Does not include the direction information.	
	0 ... 18000 rpm	Setting range	0 ... 18000
12.07	CONST SPEED 6	Defines speed 6. An absolute value. Does not include the direction information.	
	0 ... 18000 rpm	Setting range	0 ... 18000
12.08	CONST SPEED 7	Defines speed 7. An absolute value. Does not include the direction information.	
	0 ... 18000 rpm	Setting range	0 ... 18000
12.09	CONST SPEED 8	Defines speed 8. An absolute value. Does not include the direction information.	
	0 ... 18000 rpm	Setting range	0 ... 18000
12.10	CONST SPEED 9	Defines speed 9. An absolute value. Does not include the direction information.	
	0 ... 18000 rpm	Setting range	0 ... 18000
12.11	CONST SPEED 10	Defines speed 10. An absolute value. Does not include the direction information.	
	0 ... 18000 rpm	Setting range	0 ... 18000
12.12	CONST SPEED 11	Defines speed 11. An absolute value. Does not include the direction information.	
	0 ... 18000 rpm	Setting range	0 ... 18000
12.13	CONST SPEED 12	Defines speed 12. An absolute value. Does not include the direction information. Note: If inching is in use, the parameter defines the inching 1 speed. The sign is taken into account. See chapter <i>Fieldbus control</i> .	
	-18000 ... 18000 rpm	Setting range	-18000 ... 18000

Index	Name/Selection	Description	FbEq
12.14	CONST SPEED 13	Defines speed 13. An absolute value. Does not include the direction information. Note: If inching is in use, the parameter defines the inching 2 speed. The sign is taken into account. See chapter <i>Fieldbus control</i> .	
	-18000 ... 18000 rpm	Setting range	-18000 ... 18000
12.15	CONST SPEED 14	Defines speed 14. An absolute value. Does not include the direction information. Note: If the jogging function is in use, the parameter defines the jogging speed. The sign is not taken into account. See section <i>Jogging</i> on page 81.	
	0 ... 18000 rpm	Setting range	0 ... 18000
12.16	CONST SPEED 15	Defines speed 15 or Fault speed. The program considers the sign when used as a fault speed by parameter 30.01 and 30.02.	
	-18000 ... 18000 rpm	Setting range	-18000 ... 18000
13 ANALOGUE INPUTS		The analogue input signal processing. See section <i>Programmable analogue inputs</i> on page 49.	
13.01	MINIMUM AI1	Defines the minimum value for analogue input AI1. When used as a reference, the value corresponds to the reference minimum setting. Example: If AI1 is selected as the source for external reference REF1, this value corresponds to the value of parameter 11.04.	
	0 V	Zero volts. Note: The program cannot detect a loss of analogue input signal.	1
	2 V	Two volts	2
	TUNED VALUE	The value measured by the tuning function. See the selection <i>TUNE</i> .	3
	TUNE	The value measurement triggering. Procedure: - Connect the minimum signal to input. - Set the parameter to TUNE. Note: The readable range in tuning is 0 ... 10 V.	4
13.02	MAXIMUM AI1	Defines the maximum value for analogue input AI1. When used as a reference, the value corresponds to the reference maximum setting. Example: If AI1 is selected as the source for external reference REF1, this value corresponds to the value of parameter 11.05.	
	10 V	Ten volts (DC).	1
	TUNED VALUE	The value measured by the tuning function. See the selection <i>TUNE</i> .	2
	TUNE	Triggering of the tuning function. Procedure: - Connect the maximum signal to input. - Set the parameter to TUNE. Note: The readable range in tuning is 0 ... 10 V.	3

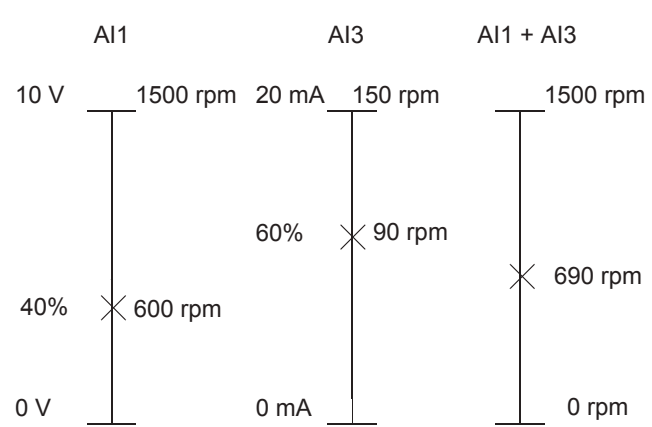
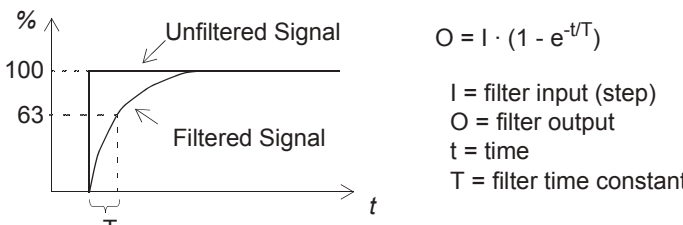
Index	Name/Selection	Description	FbEq
13.03	SCALE AI1	<p>Scales analogue input AI1.</p> <p>Example: The effect on speed reference REF1 when:</p> <ul style="list-style-type: none"> - REF1 source selection (parameter 11.03) = AI1+AI3 - REF1 maximum value setting (parameter 11.05) = 1500 rpm - Actual AI1 value = 4 V (40% of the full scale value) - Actual AI3 value = 12 mA (60% of the full scale value) - AI1 scaling = 100%, AI3 scaling = 10% 	
	0 ... 1000%	Scaling range	0 ... 32767
13.04	FILTER AI1	<p>Defines the filter time constant for analogue input AI1.</p>  <p>Note: The signal is also filtered due to the signal interface hardware (10 ms time constant). This cannot be changed by any parameter.</p>	
	0.00 ... 10.00 s	Filter time constant	0 ... 1000
13.05	INVERT AI1	Activates/deactivates the inversion of analogue input AI1.	
	NO	No inversion	0
	YES	Inversion active. The maximum value of the analogue input signal corresponds to the minimum reference and vice versa.	65535
13.06	MINIMUM AI2	See parameter 13.01.	
	0 mA	See parameter 13.01.	1
	4 mA	See parameter 13.01.	2
	TUNED VALUE	See parameter 13.01.	3
	TUNE	See parameter 13.01.	4
13.07	MAXIMUM AI2	See parameter 13.02.	
	20 mA	See parameter 13.02.	1
	TUNED VALUE	See parameter 13.02.	2
	TUNE	See parameter 13.02.	3

Index	Name/Selection	Description	FbEq
13.08	SCALE AI2	See parameter 13.03.	
	0 ... 1000%	See parameter 13.03.	0 ... 32767
13.09	FILTER AI2	See parameter 13.04.	
	0.00 ... 10.00 s	See parameter 13.04.	0 ... 1000
13.10	INVERT AI2	See parameter 13.05.	
	NO	See parameter 13.05.	0
	YES	See parameter 13.05.	65535
13.11	MINIMUM AI3	See parameter 13.01.	
	0 mA	See parameter 13.01.	1
	4 mA	See parameter 13.01.	2
	TUNED VALUE	See parameter 13.01.	3
	TUNE	See parameter 13.01.	4
13.12	MAXIMUM AI3	See parameter 13.02.	
	20 mA	See parameter 13.02.	1
	TUNED VALUE	See parameter 13.02.	2
	TUNE	See parameter 13.02.	3
13.13	SCALE AI3	See parameter 13.03.	
	0 ... 1000%	See parameter 13.03.	0 ... 32767
13.14	FILTER AI3	See parameter 13.04.	
	0.00 ... 10.00 s	See parameter 13.04.	0 ... 1000
13.15	INVERT AI3	See parameter 13.05.	
	NO	See parameter 13.05.	0
	YES	See parameter 13.05.	65535
13.16	MINIMUM AI5	See parameter 13.01. Note: If RAIO-01 is used with voltage input signal, 20 mA corresponds to 10 V.	
	0 mA	See parameter 13.01.	1
	4 mA	See parameter 13.01.	2
	TUNED VALUE	See parameter 13.01.	3
	TUNE	See parameter 13.01.	4
13.17	MAXIMUM AI5	See parameter 13.02. Note: If RAIO-01 is used with voltage input signal, 20 mA corresponds to 10 V.	
	20 mA	See parameter 13.02.	1
	TUNED VALUE	See parameter 13.02.	2
	TUNE	See parameter 13.02.	3
13.18	SCALE AI5	See parameter 13.03.	
	0 ... 1000%	See parameter 13.03.	0 ... 32767
13.19	FILTER AI5	See parameter 13.04.	
	0.00 ... 10.00 s	See parameter 13.04.	0 ... 1000

Index	Name/Selection	Description	FbEq
13.20	INVERT AI5	See parameter 13.05.	
	NO	See parameter 13.05.	0
	YES	See parameter 13.05.	65535
13.21	MINIMUM AI6	See parameter 13.01. Note: If RAIO-01 is used with voltage input signal, 20 mA corresponds to 10 V.	
	0 mA	See parameter 13.01.	1
	4 mA	See parameter 13.01.	2
	TUNED VALUE	See parameter 13.01.	3
	TUNE	See parameter 13.01.	4
13.22	MAXIMUM AI6	See parameter 13.02. Note: If RAIO-01 is used with voltage input signal, 20 mA corresponds to 10 V.	
	20 mA	See parameter 13.02.	1
	TUNED VALUE	See parameter 13.02.	2
	TUNE	See parameter 13.02.	3
13.23	SCALE AI6	See parameter 13.03.	
	0 ... 1000%	See parameter 13.03.	0 ... 32767
13.24	FILTER AI6	See parameter 13.04.	
	0.00 ... 10.00 s	See parameter 13.04.	0 ... 1000
13.25	INVERT AI6	See parameter 13.05.	
	NO	See parameter 13.05.	0
	YES	See parameter 13.05.	65535
14 RELAY OUTPUTS		Status information indicated through the relay outputs, and the relay operating delays. See section <i>Programmable relay outputs</i> on page 52.	
14.01	RELAY RO1 OUTPUT	Selects a drive status indicated through relay output RO1. The relay energises when the status meets the setting.	
	NOT USED	Not used.	1
	READY	Ready to function: Run Enable signal on, no fault.	2
	RUNNING	Running: Start signal on, Run Enable signal on, no active fault.	3
	FAULT	Fault	4
	FAULT(-1)	Inverted fault. Relay is de-energised on a fault trip.	5
	FAULT(RST)	Fault. Automatic reset after the autoreset delay. See parameter group 31 AUTOMATIC RESET .	6
	STALL WARN	Warning by the stall protection function. See parameter 30.10.	7
	STALL FLT	Fault trip by the stall protection function. See parameter 30.10.	8
	MOT TEMP WRN	Warning trip of the motor temperature supervision function. See parameter 30.04.	9
	MOT TEMP FLT	Fault trip of the motor temperature supervision function. See parameter 30.04.	10
	ACS TEMP WRN	Warning by the drive temperature supervision function. The warning limit depends on the used inverter type.	11
	ACS TEMP FLT	Fault trip by the drive temperature supervision function. Trip limit is 100%.	12
	FAULT/WARN	Fault or warning active	13
	WARNING	Warning active	14
	REVERSED	Motor rotates in reverse direction.	15

Index	Name/Selection	Description	FbEq
	EXT CTRL	Drive is under external control.	16
	REF 2 SEL	External reference REF 2 is in use.	17
	CONST SPEED	A constant speed is in use. See parameter group 12 CONSTANT SPEEDS .	18
	DC OVERVOLT	The intermediate circuit DC voltage has exceeded the overvoltage limit.	19
	DC UNDERVOLT	The intermediate circuit DC voltage has fallen below the undervoltage limit.	20
	SPEED 1 LIM	Motor speed at supervision limit 1. See parameters 32.01 and 32.02 .	21
	SPEED 2 LIM	Motor speed at supervision limit 2. See parameters 32.03 and 32.04 .	22
	CURRENT LIM	Motor current at the supervision limit. See parameters 32.05 and 32.06 .	23
	REF 1 LIM	External reference REF1 at the supervision limit. See parameters 32.11 and 32.12 .	24
	REF 2 LIM	External reference REF2 at the supervision limit. See parameters 32.13 and 32.14 .	25
	TORQUE 1 LIM	Motor torque at supervision limit 1. See parameters 32.07 and 32.08 .	26
	TORQUE 2 LIM	Motor torque at supervision limit 2. See parameters 32.09 and 32.10 .	27
	STARTED	The drive has received the start command.	28
	LOSS OF REF	The drive has no reference.	29
	AT SPEED	The actual value has reached the reference value. In speed control, the speed error is less or equal to 10% of the nominal motor speed.	30
	ACT 1 LIM	Process PID controller variable ACT1 at the supervision limit. See parameters 32.15 and 32.16 .	31
	ACT 2 LIM	Process PID controller variable ACT2 at the supervision limit. See parameters 32.17 and 32.18 .	32
	COMM.REF3(13)	The relay is controlled by fieldbus reference REF3. See chapter Fieldbus control .	33
	PARAM 14.16	Source selected by parameter 14.16 .	34
	BRAKE CTRL	On/Off control of a mechanical brake. See parameter group 42 BRAKE CONTROL and section Control of a mechanical brake on page 77 .	35
	BC SHORT CIR	Drive trips on a brake chopper fault. See chapter Fault tracing .	36
14.02	RELAY RO2 OUTPUT	Selects the drive status to be indicated through relay output RO2. The relay energises when the status meets the setting.	
	NOT USED	See parameter 14.01 .	1
	READY	See parameter 14.01 .	2
	RUNNING	See parameter 14.01 .	3
	FAULT	See parameter 14.01 .	4
	FAULT(-1)	See parameter 14.01 .	5
	FAULT(RST)	See parameter 14.01 .	6
	STALL WARN	See parameter 14.01 .	7
	STALL FLT	See parameter 14.01 .	8
	MOT TEMP WRN	See parameter 14.01 .	9
	MOT TEMP FLT	See parameter 14.01 .	10
	ACS TEMP WRN	See parameter 14.01 .	11
	ACS TEMP FLT	See parameter 14.01 .	12
	FAULT/WARN	See parameter 14.01 .	13
	WARNING	See parameter 14.01 .	14

Index	Name/Selection	Description	FbEq
	REVERSED	See parameter 14.01.	15
	EXT CTRL	See parameter 14.01.	16
	REF 2 SEL	See parameter 14.01.	17
	CONST SPEED	See parameter 14.01.	18
	DC OVERVOLT	See parameter 14.01.	19
	DC UNDERVOLT	See parameter 14.01.	20
	SPEED 1 LIM	See parameter 14.01.	21
	SPEED 2 LIM	See parameter 14.01.	22
	CURRENT LIM	See parameter 14.01.	23
	REF 1 LIM	See parameter 14.01.	24
	REF 2 LIM	See parameter 14.01.	25
	TORQUE 1 LIM	See parameter 14.01.	26
	TORQUE 2 LIM	See parameter 14.01.	27
	STARTED	See parameter 14.01.	28
	LOSS OF REF	See parameter 14.01.	29
	AT SPEED	See parameter 14.01.	30
	ACT 1 LIM	See parameter 14.01.	31
	ACT 2 LIM	See parameter 14.01.	32
	COMM. REF3(14)	See parameter 14.01.	33
	PARAM 14.17	Source selected by parameter 14.17.	34
	BRAKE CTRL	See parameter 14.01.	35
	BC SHORT CIR	See parameter 14.01.	36
14.03	RELAY RO3 OUTPUT	Selects the drive status to be indicated through relay output RO3. The relay energises when the status meets the setting.	
	NOT USED	See parameter 14.01.	1
	READY	See parameter 14.01.	2
	RUNNING	See parameter 14.01.	3
	FAULT	See parameter 14.01.	4
	FAULT(-1)	See parameter 14.01.	5
	FAULT(RST)	See parameter 14.01.	6
	STALL WARN	See parameter 14.01.	7
	STALL FLT	See parameter 14.01.	8
	MOT TEMP WRN	See parameter 14.01.	9
	MOT TEMP FLT	See parameter 14.01.	10
	ACS TEMP WRN	See parameter 14.01.	11
	ACS TEMP FLT	See parameter 14.01.	12
	FAULT/WARN	See parameter 14.01.	13
	WARNING	See parameter 14.01.	14
	REVERSED	See parameter 14.01.	15
	EXT CTRL	See parameter 14.01.	16
	REF 2 SEL	See parameter 14.01.	17
	CONST SPEED	See parameter 14.01.	18

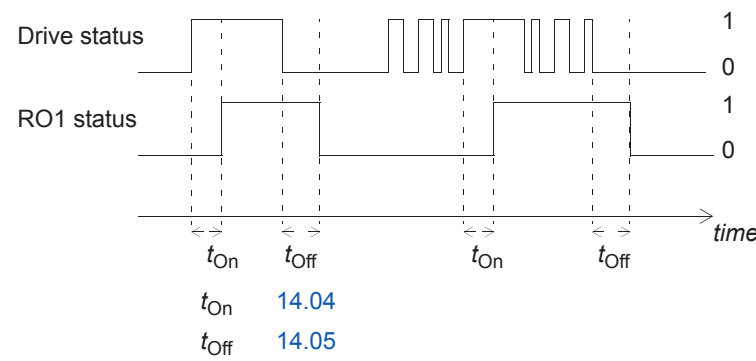
Index	Name/Selection	Description	FbEq
	DC OVERVOLT	See parameter 14.01.	19
	DC UNDERVOLT	See parameter 14.01.	20
	SPEED 1 LIM	See parameter 14.01.	21
	SPEED 2 LIM	See parameter 14.01.	22
	CURRENT LIM	See parameter 14.01.	23
	REF 1 LIM	See parameter 14.01.	24
	REF 2 LIM	See parameter 14.01.	25
	TORQUE 1 LIM	See parameter 14.01.	26
	TORQUE 2 LIM	See parameter 14.01.	27
	STARTED	See parameter 14.01.	28
	LOSS OF REF	See parameter 14.01.	29
	AT SPEED	See parameter 14.01.	30
	MAGN READY	The motor is magnetised and ready to give nominal torque (nominal magnetising of the motor has been reached).	31
	USER 2 SEL	User Macro 2 is in use.	32
	COMM. REF3(15)	See parameter 14.01.	33
	PARAM 14.18	Source selected by parameter 14.18.	34
	BRAKE CTRL	See parameter 14.01.	35
	BC SHORT CIR	See parameter 14.01.	36
14.04	RO1 TON DELAY	Defines the operation delay for the relay RO1.	
	0.0 ... 3600.0 s	Setting range. The figure below illustrates the operation (on) and release (off) delays for relay output RO1. 	0 ... 36000
14.05	RO1 TOFF DELAY	Defines the release delay for relay output RO1.	
	0.0 ... 3600.0 s	See parameter 14.04.	0 ... 36000
14.06	RO2 TON DELAY	Defines the operation delay for relay output RO2.	
	0.0 ... 3600.0 s	See parameter 14.04.	0 ... 36000
14.07	RO2 TOFF DELAY	Defines the release delay for relay output RO2.	
	0.0 ... 3600.0 s	See parameter 14.04.	0 ... 36000
14.08	RO3 TON DELAY	Defines the operation delay for relay output RO3.	
	0.0 ... 3600.0 s	See parameter 14.04.	0 ... 36000
14.09	RO3 TOFF DELAY	Defines the release delay of relay output RO3.	
	0.0 ... 3600.0 s	See parameter 14.04.	0 ... 36000

Index	Name/Selection	Description	FbEq
14.10	DIO MOD1 RO1	Selects the drive status indicated through relay output RO1 of digital I/O extension module 1 (optional, see parameter 98.03).	
	READY	See parameter 14.01.	1
	RUNNING	See parameter 14.01.	2
	FAULT	See parameter 14.01.	3
	WARNING	See parameter 14.01.	4
	REF 2 SEL	See parameter 14.01.	5
	AT SPEED	See parameter 14.01.	6
	PARAM 14.19	Source selected by parameter 14.19.	7
14.11	DIO MOD1 RO2	Selects the drive status indicated through relay output RO2 of digital I/O extension module 1 (optional, see parameter 98.03).	
	READY	See parameter 14.01.	1
	RUNNING	See parameter 14.01.	2
	FAULT	See parameter 14.01.	3
	WARNING	See parameter 14.01.	4
	REF 2 SEL	See parameter 14.01.	5
	AT SPEED	See parameter 14.01.	6
	PARAM 14.20	Source selected by parameter 14.20.	7
14.12	DIO MOD2 RO1	Selects the drive status indicated through relay output RO1 of digital I/O extension module 2 (optional, see parameter 98.04).	
	READY	See parameter 14.01.	1
	RUNNING	See parameter 14.01.	2
	FAULT	See parameter 14.01.	3
	WARNING	See parameter 14.01.	4
	REF 2 SEL	See parameter 14.01.	5
	AT SPEED	See parameter 14.01.	6
	PARAM 14.21	Source selected by parameter 14.21.	7
14.13	DIO MOD2 RO2	Selects the drive status indicated through relay output RO2 of digital I/O extension module 2 (optional, see parameter 98.04).	
	READY	See parameter 14.01.	1
	RUNNING	See parameter 14.01.	2
	FAULT	See parameter 14.01.	3
	WARNING	See parameter 14.01.	4
	REF 2 SEL	See parameter 14.01.	5
	AT SPEED	See parameter 14.01.	6
	PARAM 14.22	Source selected by parameter 14.22.	7
14.14	DIO MOD3 RO1	Selects the drive status indicated through relay output RO1 of digital I/O extension module 3 (optional, see parameter 98.05).	
	READY	See parameter 14.01.	1
	RUNNING	See parameter 14.01.	2
	FAULT	See parameter 14.01.	3
	WARNING	See parameter 14.01.	4
	REF 2 SEL	See parameter 14.01.	5

Index	Name/Selection	Description	FbEq
	AT SPEED	See parameter 14.01.	6
	PARAM 14.23	Source selected by parameter 14.23.	7
14.15	DIO MOD3 RO2	Selects the drive status indicated through relay output RO2 of digital I/O extension module no. 3 (optional, see parameter 98.05).	
	READY	See parameter 14.01.	1
	RUNNING	See parameter 14.01.	2
	FAULT	See parameter 14.01.	3
	WARNING	See parameter 14.01.	4
	REF 2 SEL	See parameter 14.01.	5
	AT SPEED	See parameter 14.01.	6
	PARAM 14.24	Source selected by parameter 14.24.	7
14.16	RO PTR1	Defines the source or constant for value PAR 14.16 of parameter 14.01.	
	-255.255.31 ... +255.255.31 / C.- 32768 ... C.32767	Parameter index or a constant value. See parameter 10.04 for information on the difference.	-
14.17	RO PTR2	Defines the source or constant for value PAR 14.17 of parameter 14.02.	
	-255.255.31 ... +255.255.31 / C.- 32768 ... C.32767	Parameter index or a constant value. See parameter 10.04 for information on the difference.	-
14.18	RO PTR3	Defines the source or constant for value PAR 14.18 of parameter 14.03.	
	-255.255.31 ... +255.255.31 / C.- 32768 ... C.32767	Parameter index or a constant value. See parameter 10.04 for information on the difference.	-
14.19	RO PTR4	Defines the source or constant for value PAR 14.19 of parameter 14.10.	
	-255.255.31 ... +255.255.31 / C.- 32768 ... C.32767	Parameter index or a constant value. See parameter 10.04 for information on the difference.	-
14.20	RO PTR5	Defines the source or constant for value PAR 14.20 of parameter 14.11.	
	-255.255.31 ... +255.255.31 / C.- 32768 ... C.32767	Parameter index or a constant value. See parameter 10.04 for information on the difference.	-
14.21	RO PTR6	Defines the source or constant for value PAR 14.21 of parameter 14.12.	
	-255.255.31 ... +255.255.31 / C.- 32768 ... C.32767	Parameter index or a constant value. See parameter 10.04 for information on the difference.	-
14.22	RO PTR7	Defines the source or constant for value PAR 14.22 of parameter 14.13.	
	-255.255.31 ... +255.255.31 / C.- 32768 ... C.32767	Parameter index or a constant value. See parameter 10.04 for information on the difference.	-
14.23	RO PTR8	Defines the source or constant for value PAR 14.23 of parameter 14.14.	
	-255.255.31 ... +255.255.31 / C.- 32768 ... C.32767	Parameter index or a constant value. See parameter 10.04 for information on the difference.	-
14.24	RO PTR9	Defines the source or constant for value PAR 14.24 of parameter 14.15.	
	-255.255.31 ... +255.255.31 / C.- 32768 ... C.32767	Parameter index or a constant value. See parameter 10.04 for information on the difference.	-

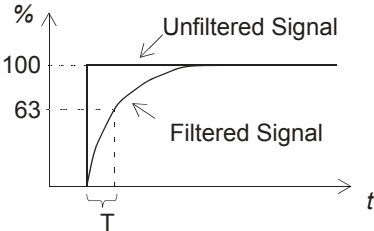

Index	Name/Selection	Description	FbEq
15 ANALOGUE OUTPUTS		Selection of the actual signals to be indicated through the analogue outputs. Output signal processing. See section <i>Programmable analogue outputs</i> on page 50.	
15.01	ANALOGUE OUTPUT1	Connects a drive signal to analogue output AO1.	
	NOT USED	Not in use	1
	P SPEED	Value of a user-defined process quantity derived from the motor speed. See parameter group 34 PROCESS VARIABLE for scaling and unit selection (%; m/s; rpm). The updating interval is 100 ms.	2
	SPEED	Motor speed (signal 01.02 SPEED). 20 mA = motor nominal speed. The updating interval is 24 ms. The value is filtered with the filter time constant defined by parameter 34.04 MOTOR SP FILT TIM.	3
	FREQUENCY	Output frequency. 20 mA = motor nominal frequency. The updating interval is 24 ms.	4
	CURRENT	Output current. 20 mA = motor nominal current. The updating interval is 24 ms.	5
	TORQUE	Motor torque. 20 mA = 100% of motor nominal rating. The updating interval is 24 ms.	6
	POWER	Motor power. 20 mA = 100% of motor nominal rating. The updating interval is 100 ms.	7
	DC BUS VOLT	DC bus voltage. 20 mA = 100% of the reference value. The reference value is 540 VDC. (= 1.35 · 400 V) for 380...415 VAC supply voltage rating and 675 VDC (= 1.35 · 500 V) for 380...500 VAC supply. The updating interval is 24 ms.	8
	OUTPUT VOLT	Motor voltage. 20 mA = motor rated voltage. The updating interval is 100 ms.	9
	APPL OUTPUT	The reference which is given as an output from the application. For example, if the PID Control macro is in use, this is the output of the process PID controller. The updating interval is 24 ms.	10
	REFERENCE	Active reference that the drive is currently following. 20 mA = 100 % of the active reference. The updating interval is 24 ms.	11
	CONTROL DEV	The difference between the reference and the actual value of the process PID controller. 0/4 mA = -100%, 10/12 mA = 0%, 20 mA = 100%. The updating interval is 24 ms.	12
	ACTUAL 1	Value of variable ACT1 used in the process PID control. 20 mA = value of parameter 40.10. The updating interval is 24 ms.	13
	ACTUAL 2	Value of variable ACT2 used in the process PID control. 20 mA = value of parameter 40.12. The updating interval is 24 ms.	14
	COMM.REF4	The value is read from fieldbus reference REF4. See chapter <i>Fieldbus control</i> .	15
	M1 TEMP MEAS	Analogue output is a current source in a motor temperature measuring circuit. Depending on the sensor type, the output is 9.1 mA (Pt 100) or 1.6 mA (PTC). For more information, see parameter 35.01 and section <i>Motor temperature measurement through the standard I/O</i> on page 73. Note: The settings of parameters 15.02 to 15.05 are not effective.	16
	PARAM 15.11	Source selected by 15.11	17
15.02	INVERT AO1	Inverts the analogue output AO1 signal. The analogue signal is at the minimum level when the indicated drive signal is at its maximum level and vice versa.	
	NO	Inversion off	0
	YES	Inversion on	65535

Index	Name/Selection	Description	FbEq
15.03	MINIMUM AO1	Defines the minimum value of the analogue output signal AO1.	
	0 mA	Zero mA	1
	4 mA	Four mA	2
15.04	FILTER AO1	Defines the filtering time constant for analogue output AO1.	
	0.00 ... 10.00 s	<p>Filter time constant</p>  <p>$O = I \cdot (1 - e^{-t/T})$</p> <p>I = filter input (step) O = filter output t = time T = filter time constant</p> <p>Note: Even if you select 0 s as the minimum value, the signal is still filtered with a time constant of 10 ms due to the signal interface hardware. This cannot be changed by any parameters.</p>	0 ... 1000
15.05	SCALE AO1	Scales the analogue output AO1 signal.	
	10 ... 1000%	<p>Scaling factor. If the value is 100%, the reference value of the drive signal corresponds to 20 mA.</p> <p>Example: The nominal motor current is 7.5 A and the measured maximum current at maximum load 5 A. The motor current 0 to 5 A needs to be read as 0 to 20 mA analogue signal through AO1. The required settings are:</p> <ol style="list-style-type: none"> 1. AO1 is set to CURRENT by parameter 15.01. 2. AO1 minimum is set to 0 mA by parameter 15.03. 3. The measured maximum motor current is scaled to correspond to 20 mA analogue output signal by setting the scaling factor (k) to 150%. The value is defined as follows: The reference value of the output signal CURRENT is the motor nominal current i.e. 7.5 A (see parameter 15.01). To make the measured maximum motor current correspond to 20 mA, it should be scaled equal to the reference value before it is converted to an analogue output signal. Equation: $k \cdot 5 \text{ A} = 7.5 \text{ A} \Rightarrow k = 1.5 = 150\%$ 	100 ... 10000
15.06	ANALOGUE OUTPUT2	See parameter 15.01.	
	NOT USED	See parameter 15.01.	1
	P SPEED	See parameter 15.01.	2
	SPEED	See parameter 15.01.	3
	FREQUENCY	See parameter 15.01.	4
	CURRENT	See parameter 15.01.	5
	TORQUE	See parameter 15.01.	6
	POWER	See parameter 15.01.	7
	DC BUS VOLT	See parameter 15.01.	8
	OUTPUT VOLT	See parameter 15.01.	9
	APPL OUTPUT	See parameter 15.01.	10
	REFERENCE	See parameter 15.01.	11
	CONTROL DEV	See parameter 15.01.	12
	ACTUAL 1	See parameter 15.01.	13

Index	Name/Selection	Description	FbEq
	ACTUAL 2	See parameter 15.01.	14
	COMM.REF5	The value is read from fieldbus reference REF5. See chapter <i>Fieldbus control</i> .	15
	PARAM 15.12	Source selected by 15.12	16
15.07	INVERT AO2	See parameter 15.02.	
	NO	See parameter 15.02.	0
	YES	See parameter 15.02.	65535
15.08	MINIMUM AO2	See parameter 15.03.	
	0 mA	See parameter 15.03.	1
	4 mA	See parameter 15.03.	2
15.09	FILTER AO2	See parameter 15.04.	
	0.00 ... 10.00 s	See parameter 15.04.	0 ... 1000
15.10	SCALE AO2	See parameter 15.05.	
	10 ... 1000%	See parameter 15.05.	100 ... 10000
15.11	AO1 PTR	Defines the source or constant for value PAR 15.11 of parameter 15.01.	
	-255.255.31 ... +255.255.31 / C.- 32768 ... C.32767	Parameter index or a constant value. See parameter 10.04 for information on the difference.	1000 = 1 mA
15.12	AO2 PTR	Defines the source or constant for value PAR 15.12 of parameter 15.06.	
	-255.255.31 ... +255.255.31 / C.- 32768 ... C.32767	Parameter index or a constant value. See parameter 10.04 for information on the difference.	1000 = 1 mA
16 SYST CTRL INPUTS		Run Enable, parameter lock etc.	
16.01	RUN ENABLE	Sets the Run Enable signal on, or selects a source for the external Run Enable signal. If Run Enable signal is switched off, the drive will not start or stops if it is running. The stop mode is set by parameter 21.07.	
	YES	Run Enable signal is on.	1
	DI1	External signal required through digital input DI1. 1 = Run Enable.	2
	DI2	See selection DI1.	3
	DI3	See selection DI1.	4
	DI4	See selection DI1.	5
	DI5	See selection DI1.	6
	DI6	See selection DI1.	7
	COMM.CW	External signal required through the Fieldbus Control Word (bit 3).	8
	DI7	See selection DI1.	9
	DI8	See selection DI1.	10
	DI9	See selection DI1.	11
	DI10	See selection DI1.	12
	DI11	See selection DI1.	13
	DI12	See selection DI1.	14
	PARAM 16.08	Source selected by parameter 16.08.	15



Index	Name/Selection	Description	FbEq
16.02	PARAMETER LOCK	Selects the state of the parameter lock. The lock prevents parameter changing.	
	OPEN	The lock is open. Parameter values can be changed.	0
	LOCKED	Locked. Parameter values cannot be changed from the control panel. The lock can be opened by entering the valid code to parameter 16.03.	65535
16.03	PASS CODE	Selects the pass code for the parameter lock (see parameter 16.02).	
	0 ... 30000	Setting 358 opens the lock. The value reverts back to 0 automatically.	0 ... 30000
16.04	FAULT RESET SEL	Selects the source for the fault reset signal. The signal resets the drive after a fault trip if the cause of the fault no longer exists.	
	NOT SEL	Fault reset only from the control panel keypad (RESET key).	1
	DI1	Reset through digital input DI1 or by control panel: - If the drive is in external control mode: Reset by a rising edge of DI1. - If the drive is in local control mode: Reset by the RESET key of the control panel.	2
	DI2	See selection DI1.	3
	DI3	See selection DI1.	4
	DI4	See selection DI1.	5
	DI5	See selection DI1.	6
	DI6	See selection DI1.	7
	COMM.CW	Reset through the fieldbus Control Word (bit 7), or by the RESET key of the control panel. Note: Reset through fieldbus Control Word (bit 7) is enabled automatically and it is independent of parameter 16.04 setting if parameter 10.01 or 10.02 is set to COMM.CW.	8
	ON STOP	Reset along with the stop signal received through a digital input, or by the RESET key of the control panel.	9
	DI7	See selection DI1.	10
	DI8	See selection DI1.	11
	DI9	See selection DI1.	12
	DI10	See selection DI1.	13
	DI11	See selection DI1.	14
	DI12	See selection DI1.	15
	PARAM 16.11	Source selected by parameter 16.11.	16
16.05	USER MACRO IO CHG	Enables the change of the User Macro through a digital input. See parameter 99.02. The change is only allowed when the drive is stopped. During the change, the drive will not start. Note: Always save the User Macro by parameter 99.02 after changing any parameter settings, or reperforming the motor identification. <u>The last settings saved by the user are loaded into use whenever the power is switched off and on again or the macro is changed. Any unsaved changes will be lost.</u> Note: The value of this parameter is not included in the User Macro. A setting once made remains despite the User Macro change. Note: Selection of User Macro 2 can be supervised via relay output RO3. See parameter 14.03 for more information.	
	NOT SEL	User macro change is not possible through a digital input.	1
	DI1	Falling edge of digital input DI1: User Macro 1 is loaded into use. Rising edge of digital input DI1: User Macro 2 is loaded into use.	2

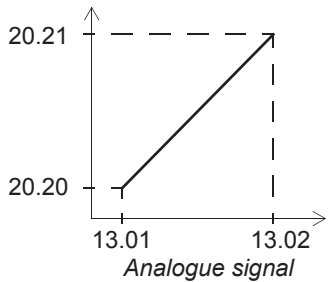

Index	Name/Selection	Description	FbEq
	DI2	See selection DI1.	3
	DI3	See selection DI1.	4
	DI4	See selection DI1.	5
	DI5	See selection DI1.	6
	DI6	See selection DI1.	7
	DI7	See selection DI1.	8
	DI8	See selection DI1.	9
	DI9	See selection DI1.	10
	DI10	See selection DI1.	11
	DI11	See selection DI1.	12
	DI12	See selection DI1.	13
16.06	LOCAL LOCK	Disables entering local control mode (LOC/REM key of the panel).  WARNING! Before activating, ensure that the control panel is not needed for stopping the drive!	
	OFF	Local control allowed.	0
	ON	Local control disabled.	65535
16.07	PARAMETER SAVE	Saves the valid parameter values to the permanent memory. Note: A new parameter value of a standard macro is saved automatically when changed from the panel but not when altered through a fieldbus connection.	
	DONE	Saving completed	0
	SAVE..	Saving in progress	1
16.08	RUN ENA PTR	Defines the source or constant for value PAR 16.08 of parameter 16.01	
	-255.255.31 ... +255.255.31 / C.- 32768 ... C.32767	Parameter index or a constant value. See parameter 10.04 for information on the difference.	-
16.09	CTRL BOARD SUPPLY	Defines the source of the control board power supply. Note: If an external supply is used but this parameter has value INTERNAL, the drive trips on a fault at power switch off.	
	INTERNAL 24V	Internal (default).	1
	EXTERNAL 24V	External. The control board is powered from an external supply.	2
16.10	ASSIST SEL	Enables the Start-up Assistant.	
	OFF	Assistant disabled.	0
	ON	Assistant enabled.	65535
16.11	FAULT RESET PTR	Defines the source or constant for selection PARAM 16.11 of parameter 16.04 .	
	-255.255.31 ... +255.255.31 / C.- 32768 ... C.32767	Parameter index or a constant value. See parameter 10.04 for information on the difference.	-
16.12	RESET COUNTER	Resets the cooling fan running time counter or kWh counter.	
	NO	No reset.	0
	FAN ON-TIME	Resets the running time counter of the drive cooling fan indicated with 01.44 FAN ON-TIME.	1
	kWh	kWh counter reset. See parameter 01.15 KILOWATT HOURS.	2

Index	Name/Selection	Description	FbEq
20 LIMITS		Drive operation limits. See also section <i>Speed controller tuning</i> on page 60.	
20.01	MINIMUM SPEED	Defines the allowed minimum speed. The limit cannot be set if parameter 99.04 = SCALAR.  Note: The limit is linked to the motor nominal speed setting i.e. parameter 99.08. If 99.08 is changed, the default speed limit will also change.	
	-18000 / (no. of pole pairs) ... par. 20.02 rpm	Minimum speed limit. Note: If the value is positive, the motor cannot be run in the reverse direction.	1 = 1 rpm
20.02	MAXIMUM SPEED	Defines the allowed maximum speed. The value cannot be set if parameter 99.04 = SCALAR.  Note: The limit is linked to the motor nominal speed setting i.e. parameter 99.08. If 99.08 is changed, the default speed limit will also change.	
	par. 20.01 ... 18000 / (no. of pole pairs) rpm	Maximum speed limit	1 = 1 rpm
20.03	MAXIMUM CURRENT	Defines the allowed maximum motor current.	
	0.0 ... x.x A	Current limit	0 ... 10·x.x
20.04	TORQ MAX LIM1	Defines the maximum torque limit 1 for the drive.	
	0.0 ... 600.0%	Value of limit in percent of motor nominal torque.	0 ... 60000
20.05	OVERVOLTAGE CTRL	Activates or deactivates the overvoltage control of the intermediate DC link. Fast braking of a high inertia load causes the voltage to rise to the overvoltage control limit. To prevent the DC voltage from exceeding the limit, the overvoltage controller automatically decreases the braking torque. Note: If a brake chopper and resistor are connected to the drive, the controller must be off (selection NO) to allow chopper operation.	
	OFF	Overvoltage control deactivated.	0
	ON	Overvoltage control activated.	65535
20.06	UNDERVOLTAGE CTRL	Activates or deactivates the undervoltage control of the intermediate DC link. If the DC voltage drops due to input power cut off, the undervoltage controller will automatically decrease the motor speed in order to keep the voltage above the lower limit. By decreasing the motor speed, the inertia of the load will cause regeneration back into the drive, keeping the DC link charged and preventing an undervoltage trip until the motor coasts to stop. This will act as a power-loss ride-through functionality in systems with a high inertia, such as a centrifuge or a fan.	
	OFF	Undervoltage control deactivated.	0
	ON	Undervoltage control activated.	65535
20.07	MINIMUM FREQ	Defines the minimum limit for the drive output frequency. The limit can be set only parameter 99.04 = SCALAR.	
	-300.00 ... 50 Hz	Minimum frequency limit. Note: If the value is positive, the motor cannot be run in the reverse direction.	-30000 ... 5000
20.08	MAXIMUM FREQ	Defines the maximum limit for the drive output frequency. The limit can be set only if parameter 99.04 = SCALAR	
	-50 ... 300.00 Hz	Maximum frequency limit	-5000 ... 30000

Index	Name/Selection	Description	FbEq
20.11	P MOTORING LIM	Defines the allowed maximum power fed by the inverter to the motor.	
	0 ... 600%	Power limit in percent of the motor nominal power	0 ... 60000
20.12	P GENERATING LIM	Defines the allowed maximum power fed by the motor to the inverter.	
	-600 ... 0%	Power limit in percent of the motor nominal power	-60000 ... 0
20.13	MIN TORQ SEL	Selects the minimum torque limit for the drive. The update interval is 100 ms.	
	MIN LIM1	Value of parameter 20.15 .	1
	DI1	Digital input DI1. 0: Value of parameter 20.15 . 1: Value of parameter 20.16 .	2
	DI2	See selection DI1.	3
	DI3	See selection DI1.	4
	DI4	See selection DI1.	5
	DI5	See selection DI1.	6
	DI6	See selection DI1.	7
	DI7	See selection DI1.	8
	DI8	See selection DI1.	9
	DI9	See selection DI1.	10
	DI10	See selection DI1.	11
	DI11	See selection DI1.	12
	DI12	See selection DI1.	13
	AI1	Analogue input AI1. See parameter 20.20 on how the signal is converted to a torque limit.	14
	AI2	See selection AI1.	15
	AI3	See selection AI1.	16
	AI5	See selection AI1.	17
	AI6	See selection AI1.	18
	PARAM 20.18	Limit given by 20.18	19
	NEG MAX TORQ	Inverted maximum torque limit defined by parameter 20.14	20
20.14	MAX TORQ SEL	Defines the maximum torque limit for the drive. The update interval is 100 ms.	
	MAX LIM1	Value of parameter 20.04 .	1
	DI1	Digital input DI1. 0: Value of parameter 20.04 . 1: Value of parameter 20.17 .	2
	DI2	See selection DI1.	3
	DI3	See selection DI1.	4
	DI4	See selection DI1.	5
	DI5	See selection DI1.	6
	DI6	See selection DI1.	7
	DI7	See selection DI1.	8
	DI8	See selection DI1.	9
	DI9	See selection DI1.	10
	DI10	See selection DI1.	11
	DI11	See selection DI1.	12
	DI12	See selection DI1.	13
	AI1	Analogue input AI1. See parameter 20.20 on how the signal is converted to a torque limit.	14

Index	Name/Selection	Description	FbEq								
	AI2	See selection AI1.	15								
	AI3	See selection AI1.	16								
	AI5	See selection AI1.	17								
	AI6	See selection AI1.	18								
	PARAM 20.19	Limit given by 20.19	19								
20.15	TORQ MIN LIM1	Defines the minimum torque limit 1 for the drive.									
	-600.0 ... 0.0%	Value of limit in percent of motor nominal torque	-60000 ... 0								
20.16	TORQ MIN LIM2	Defines the minimum torque limit 2 for the drive.									
	-600.0 ... 0.0%	Value of limit in percent of motor nominal torque	-60000 ... 0								
20.17	TORQ MAX LIM2	Defines the maximum torque limit 2 for the drive.									
	0.0 ... 600.0%	Value of limit in percent of motor nominal torque	0 ... 60000								
20.18	TORQ MIN PTR	Defines the source or constant for value PAR 20.18 of parameter 20.13									
	-255.255.31 ... +255.255.31 / C.- 32768 ... C.32767	Parameter index or a constant value.	100 = 1%								
20.19	TORQ MAX PTR	Defines the source or constant for value PAR 20.19 of parameter 20.14									
	-255.255.31 ... +255.255.31 / C.- 32768 ... C.32767	Parameter index or a constant value. See parameter 10.04 for information on the difference. FbEq for the torque value is 100 = 1%.	100 = 1%								
20.20	MIN AI SCALE	<p>Defines how an analogue signal (mA or V) is converted to a torque minimum or maximum limit (%). The figure below illustrate the converting, when analogue input AI1 has been set the source for a torque limit by parameter 20.13 or 20.14.</p> <p><i>Torque limit</i></p>  <table border="1" data-bbox="785 1205 1264 1361"> <tr> <td>13.01</td> <td>Minimum setting for AI1</td> </tr> <tr> <td>13.02</td> <td>Maximum setting for AI1</td> </tr> <tr> <td>20.20</td> <td>Minimum torque</td> </tr> <tr> <td>20.21</td> <td>Maximum torque</td> </tr> </table>	13.01	Minimum setting for AI1	13.02	Maximum setting for AI1	20.20	Minimum torque	20.21	Maximum torque	
13.01	Minimum setting for AI1										
13.02	Maximum setting for AI1										
20.20	Minimum torque										
20.21	Maximum torque										
	0.0 ... 600.0%	%-value that corresponds to the minimum setting of the analogue input.	100 = 1%								
20.21	MAX AI SCALE	See parameter 20.20.									
	0.0 ... 600.0%	%-value that corresponds to the maximum setting of the analogue input.	100 = 1%								
20.22	SLS SPEED LIMIT	<p>Defines the safely-limited speed limit (SLS). When the SLS function is activated the speed limits are ramped to 20.22 SLS SPEED LIMIT. The speed of the deceleration to SLS is defined by parameter 22.11 and acceleration from SLS to the original speed is defined by parameter 22.10.</p> <p>Note: This parameter is available in AS7R firmware version only.</p>	20000 = 1500 rpm								
	0...9000 rpm (0...4 times sync speed)										
21 START/STOP		Start and stop modes of the motor.									
21.01	START FUNCTION	Selects the motor starting method. See also section <i>Automatic Start</i> on page 54.									

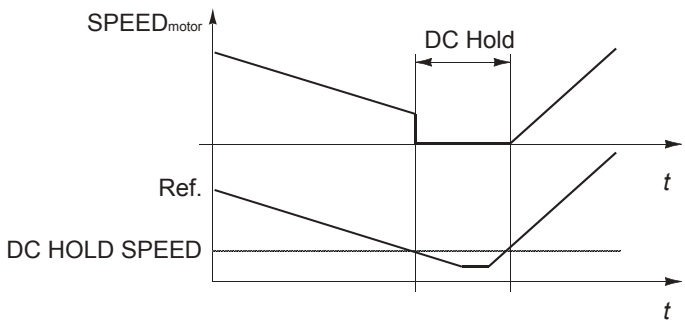
Index	Name/Selection	Description	FbEq								
	AUTO	<p>Automatic start guarantees optimal motor start in most cases. It includes the flying start function (starting to a rotating machine) and the automatic restart function (stopped motor can be restarted immediately without waiting the motor flux to die away). The drive motor control program identifies the flux as well as the mechanical state of the motor and starts the motor instantly under all conditions.</p> <p>Note: If parameter 99.04 = SCALAR, no flying start or automatic restart is possible by default. The flying start feature needs to be activated separately by parameter 21.08.</p>	1								
	DC MAGN	<p>DC magnetising should be selected if a high break-away torque is required. The drive pre-magnetises the motor before the start. The pre-magnetising time is determined automatically, being typically 200 ms to 2 s depending on the motor size. DC MAGN guarantees the highest possible break-away torque.</p> <p>Note: Starting to a rotating machine is not possible when DC magnetising is selected.</p> <p>Note: DC magnetising cannot be selected if parameter 99.04 = SCALAR.</p>	2								
	CNST DC MAGN	<p>Constant DC magnetising should be selected instead of DC magnetising if constant pre-magnetising time is required (e.g. if the motor start must be simultaneous with a mechanical brake release). This selection also guarantees the highest possible break-away torque when the pre-magnetising time is set long enough. The pre-magnetising time is defined by parameter 21.02.</p> <p>Note: Starting to a rotating machine is not possible when DC magnetising is selected.</p> <p>Note: DC magnetising cannot be selected if parameter 99.04 = SCALAR.</p> <p> WARNING! The drive will start after the set magnetising time has passed although the motor magnetisation is not completed. Ensure always in applications where a full break-away torque is essential, that the constant magnetising time is long enough to allow generation of full magnetisation and torque.</p>	3								
21.02	CONST MAGN TIME	<p>Defines the magnetising time in the constant magnetising mode. See parameter 21.01. After the start command, the drive automatically pre-magnetises the motor the set time.</p>									
	30.0 ... 10000.0 ms	<p>Magnetising time. To ensure full magnetising, set this value to the same value as or higher than the rotor time constant. If not known, use the rule-of-thumb value given in the table below:</p> <table border="1" data-bbox="544 1435 1342 1597"> <thead> <tr> <th>Motor Rated Power</th> <th>Constant Magnetising Time</th> </tr> </thead> <tbody> <tr> <td>< 10 kW</td> <td>≥ 100 to 200 ms</td> </tr> <tr> <td>10 to 200 kW</td> <td>≥ 200 to 1000 ms</td> </tr> <tr> <td>200 to 1000 kW</td> <td>≥ 1000 to 2000 ms</td> </tr> </tbody> </table>	Motor Rated Power	Constant Magnetising Time	< 10 kW	≥ 100 to 200 ms	10 to 200 kW	≥ 200 to 1000 ms	200 to 1000 kW	≥ 1000 to 2000 ms	30 ... 10000
Motor Rated Power	Constant Magnetising Time										
< 10 kW	≥ 100 to 200 ms										
10 to 200 kW	≥ 200 to 1000 ms										
200 to 1000 kW	≥ 1000 to 2000 ms										
21.03	STOP FUNCTION	<p>Selects the motor stop function.</p>									
	COAST	<p>Stop by cutting of the motor power supply. The motor coasts to a stop.</p> <p> WARNING! If the mechanical brake control function is on, the application program uses ramp stop in spite of the selection COAST (see parameter group 42 BRAKE CONTROL).</p>	1								
	RAMP	<p>Stop along a ramp. See parameter group 22 ACCEL/DECEL.</p>	2								

Index	Name/Selection	Description	FbEq
21.04	DC HOLD	<p>Activates/deactivates the DC hold function. DC Hold is not possible if parameter 99.04 = SCALAR.</p> <p>When both the reference and the speed drop below the value of parameter 21.05, the drive will stop generating sinusoidal current and start to inject DC into the motor. The current is set by parameter 21.06. When the reference speed exceeds parameter 21.05, normal drive operation continues.</p>  <p>Note: DC Hold has no effect if the start signal is switched off.</p> <p>Note: Injecting DC current into the motor causes the motor to heat up. In applications where long DC hold times are required, externally ventilated motors should be used. If the DC hold period is long, the DC hold cannot prevent the motor shaft from rotating if a constant load is applied to the motor. See section <i>DC Hold</i> on page 57.</p>	
	NO	Inactive	0
	YES	Active	65535
21.05	DC HOLD SPEED	Defines the DC Hold speed. See parameter 21.04.	
	0 ... 3000 rpm	Speed in rpm	0 ... 3000
21.06	DC HOLD CURR	Defines the DC hold current. See parameter 21.04.	
	0 ... 100%	Current in percent of the motor nominal current	0 ... 100
21.07	RUN ENABLE FUNC	<p>Selects the stop mode applied when the Run Enable signal is switched off. The Run Enable signal is put into use by parameter 16.01.</p> <p>Note: The setting overrides the normal stop mode setting (parameter 21.03) when the Run Enable signal is switched off.</p> <p> WARNING! The drive will restart after the Run Enable signal restores (if the start signal is on).</p>	
	RAMP STOP	The application program stops the drive along the deceleration ramp defined in group 22 ACCEL/DECEL.	1
	COAST STOP	<p>The application program stops the drive by cutting off the motor power supply (the inverter IGBTs are blocked). The motor rotates freely to zero speed.</p> <p> WARNING! If the brake control function is on, the application program uses ramp stop in spite of the selection COAST STOP (see parameter group 42 BRAKE CONTROL).</p>	2
	OFF2 STOP	The application program stops the drive by cutting off the motor power supply (the inverter IGBTs are blocked). The motor rotates freely to zero speed. The drive will restart only when the Run Enable signal is on and the start signal is switched on (the program receives the rising edge of the start signal).	3

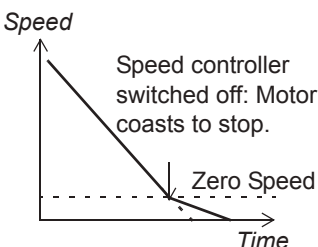
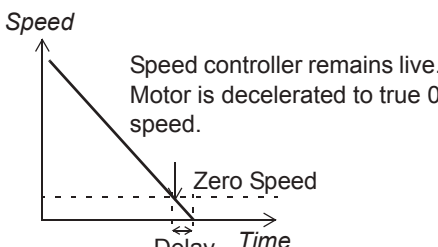
Index	Name/Selection	Description	FbEq
	OFF3 STOP	The application program stops the drive along the ramp defined by parameter 22.07. The drive will restart only when the Run Enable is on and the start signal is switched on (the program receives the rising edge of the start signal).	4
21.08	SCALAR FLY START	Activates the flying start feature in the scalar control mode. See parameters 21.01 and 99.04.	
	NO	Inactive	0
	YES	Active	65535
21.09	START INTRL FUNC	Defines how the Start Interlock input on RMIO board affects the drive operation.	
	OFF2 STOP	Drive running: 1 = Normal operation. 0 = Stop by coasting. Drive stopped: 1 = Start allowed. 0 = No start allowed. Restart after OFF2 STOP: Input is back to 1 and the drive receives rising edge of the Start signal.	1
	OFF3 STOP	Drive running: 1 = Normal operation. 0 = Stop by ramp. The ramp time is defined by parameter 22.07 EM STOP RAMP. Drive stopped: 1 = Normal start. 0 = No start allowed. Restart after OFF3 STOP: Start Interlock input = 1 and the drive receives rising edge of the Start signal.	2
21.10	ZERO SPEED DELAY	<p>Defines the delay for the zero speed delay function. The function is useful in applications where a smooth and quick restarting is essential. During the delay the drive knows accurately the rotor position.</p> <div style="display: flex; justify-content: space-around;"> <div style="text-align: center;"> <p>No Zero Speed Delay</p>  </div> <div style="text-align: center;"> <p>With Zero Speed Delay</p>  </div> </div> <p>No Zero Speed Delay The drive receives a stop command and decelerates along a ramp. When the motor actual speed falls below an internal limit (called Zero Speed), the speed controller is switched off. The inverter modulation is stopped and the motor coasts to standstill.</p> <p>With Zero Speed Delay The drive receives a stop command and decelerates along a ramp. When the actual motor speed falls below an internal limit (called Zero Speed), the zero speed delay function activates. During the delay the functions keeps the speed controller live: the inverter modulates, motor is magnetised and the drive is ready for a quick restart.</p>	
	0.0 ... 60.0 s	Delay time	10 = 1 s
22 ACCEL/DECEL		Acceleration and deceleration times. See section Acceleration and deceleration ramps on page 59.	
22.01	ACC/DEC SEL	Selects the active acceleration/deceleration time pair.	
	ACC/DEC 1	Acceleration time 1 and deceleration time 1 are used. See parameters 22.02 and 22.03.	1

Index	Name/Selection	Description	FbEq
	ACC/DEC 2	Acceleration time 2 and deceleration time 2 are used. See parameters 22.04 and 22.05 .	2
	DI1	Acceleration/deceleration time pair selection through digital input DI1. 0 = Acceleration time 1 and deceleration time 1 are in use. 1 = Acceleration time 2 and deceleration time 2 are in use.	3
	DI2	See selection DI1 .	4
	DI3	See selection DI1 .	5
	DI4	See selection DI1 .	6
	DI5	See selection DI1 .	7
	DI6	See selection DI1 .	8
	DI7	See selection DI1 .	9
	DI8	See selection DI1 .	10
	DI9	See selection DI1 .	11
	DI10	See selection DI1 .	12
	DI11	See selection DI1 .	13
	DI12	See selection DI1 .	14
	PAR 22.08&09	Acceleration and deceleration times given by parameters 22.08 and 22.09	15
22.02	ACCEL TIME 1	<p>Defines the acceleration time 1 i.e. the time required for the speed to change from zero to the maximum speed.</p> <ul style="list-style-type: none"> - If the speed reference increases faster than the set acceleration rate, the motor speed will follow the acceleration rate. - If the speed reference increases slower than the set acceleration rate, the motor speed will follow the reference signal. - If the acceleration time is set too short, the drive will automatically prolong the acceleration in order not to exceed the drive operating limits. 	
	0.00 ... 1800.00 s	Acceleration time	0 ... 18000
22.03	DECEL TIME 1	<p>Defines the deceleration time 1 i.e. the time required for the speed to change from the maximum (see parameter 20.02) to zero.</p> <ul style="list-style-type: none"> - If the speed reference decreases slower than the set deceleration rate, the motor speed will follow the reference signal. - If the reference changes faster than the set deceleration rate, the motor speed will follow the deceleration rate. - If the deceleration time is set too short, the drive will automatically prolong the deceleration in order not to exceed drive operating limits. If there is any doubt about the deceleration time being too short, ensure that the DC overvoltage control is on (parameter 20.05). <p>Note: If a short deceleration time is needed for a high inertia application, the drive should be equipped with an electric braking option e.g. with a brake chopper and a brake resistor.</p>	
	0.00 ... 1800.00 s	Deceleration time	0 ... 18000
22.04	ACCEL TIME 2	See parameter 22.02 .	
	0.00 ... 1800.00 s	See parameter 22.02 .	0 ... 18000
22.05	DECEL TIME 2	See parameter 22.03 .	
	0.00 ... 1800.00 s	See parameter 22.03 .	0 ... 18000

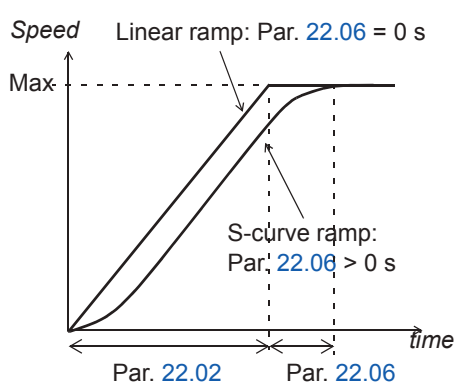
Index	Name/Selection	Description	FbEq
22.06	ACC/DEC RAMP SHPE	Selects the shape of the acceleration/deceleration ramp. See also section Jogging on page 81.	
	0.00 ... 1000.00 s	<p>0.00 s: Linear ramp. Suitable for steady acceleration or deceleration and for slow ramps.</p> <p>0.01 ... 1000.00 s: S-curve ramp. S-curve ramps are ideal for conveyors carrying fragile loads, or other applications where a smooth transition is required when changing from one speed to another. The S curve consists of symmetrical curves at both ends of the ramp and a linear part in between.</p> <p>A rule of thumb A suitable relation between the ramp shape time and the acceleration ramp time is 1/5.</p> 	0 ... 100000
22.07	EM STOP RAMP TIME	<p>Defines the time inside which the drive is stopped if</p> <ul style="list-style-type: none"> - the drive receives an emergency stop command or - the Run Enable signal is switched off and the Run Enable function has value OFF3 (see parameter 21.07). <p>The emergency stop command can be given through a fieldbus or an Emergency Stop module (optional). Consult the local ABB representative for more information on the optional module and the related settings of the Standard Control Program.</p>	
	0.00 ... 2000.00 s	Deceleration time	0 ... 200000
22.08	ACC PTR	Defines the source or constant for value PAR 22.08&09 of parameter 22.01.	
	-255.255.31 ... +255.255.31 / C.- 32768 ... C.32767	Parameter index or a constant value. See parameter 10.04 for information on the difference.	100 = 1 s
22.09	DEC PTR	Defines the source or constant for value PAR 22.08&09 of parameter 22.01	
	-255.255.31 ... +255.255.31 / C.- 32768 ... C.32767	Parameter index or a constant value. See parameter 10.04 for information on the difference.	100 = 1 s
22.10	SLS ACCELER TIME	<p>Defines the time required for the speed limits to ramp up from the safely-limited speed defined by parameter 20.22 to the speed limits defined by parameters 20.01 MINIMUM SPEED and 20.02 MAXIMUM SPEED when the SLS function is deactivated.</p> <p>Note: This parameter is available in AS7R firmware version only.</p>	100 = 1 s
	0...1800 s	Speed ramp time.	

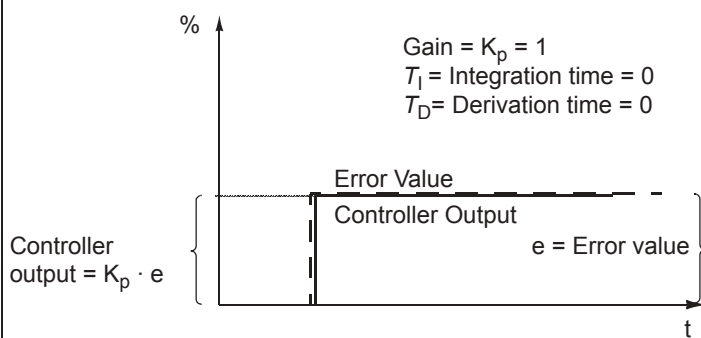
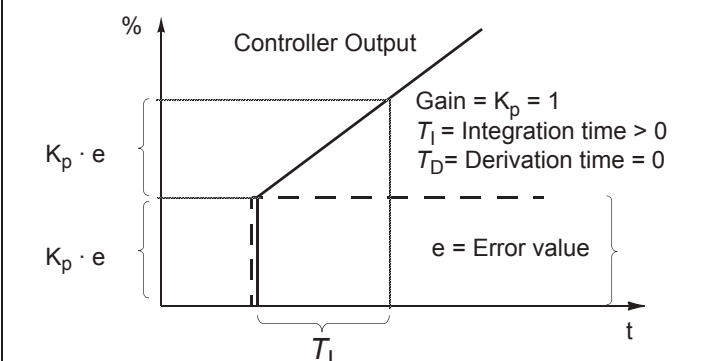
Index	Name/Selection	Description	FbEq
22.11	SLS DECELER TIME	<p>Defines the time required for the speed limits to ramp down from the value defined by parameters 20.01 MINIMUM SPEED and 20.02 MAXIMUM SPEED to the safely-limited speed defined by parameter 20.22 when the SLS function is activated.</p> <p>If the speed is already lower than the safely-limited speed, the speed does not change.</p> <p>Note: This parameter is available in AS7R firmware version only.</p>	100 = 1 s
	0...1800 s	Speed ramp time.	
23 SPEED CTRL		Speed controller variables. The parameters are not visible if parameter 99.04 = SCALAR. See section Speed controller tuning on page 60.	
23.01	GAIN	<p>Defines a relative gain for the speed controller. Great gain may cause speed oscillation.</p> <p>The figure below shows the speed controller output after an error step when the error remains constant.</p>  <p>Gain = $K_p = 1$ $T_I =$ Integration time = 0 $T_D =$ Derivation time = 0</p> <p>Controller output = $K_p \cdot e$</p>	
	0.0 ... 250.0	Gain	0 ... 25000
23.02	INTEGRATION TIME	<p>Defines an integration time for the speed controller. The integration time defines the rate at which the controller output changes when the error value is constant. The shorter the integration time, the faster the continuous error value is corrected. Too short an integration time makes the control unstable.</p> <p>The figure below shows the speed controller output after an error step when the error remains constant.</p>  <p>Gain = $K_p = 1$ $T_I =$ Integration time > 0 $T_D =$ Derivation time = 0</p> <p>$K_p \cdot e$</p> <p>$K_p \cdot e$</p> <p>T_I</p>	
	0.01 ... 999.97 s	Integration time	10 ... 999970

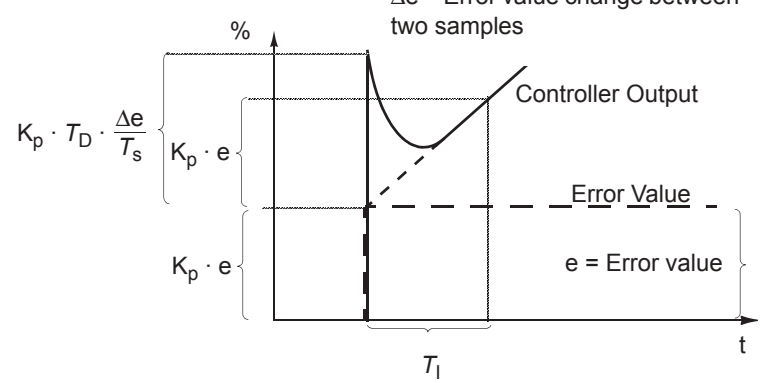
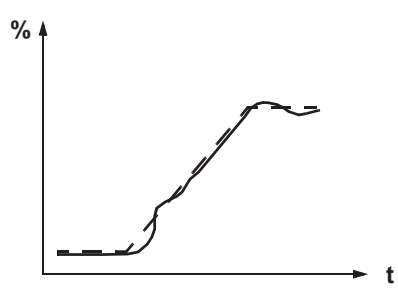
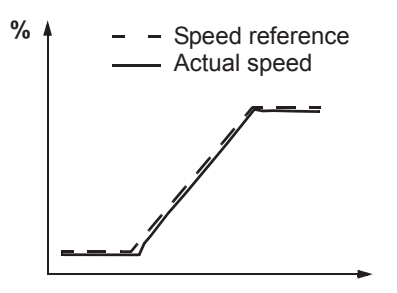

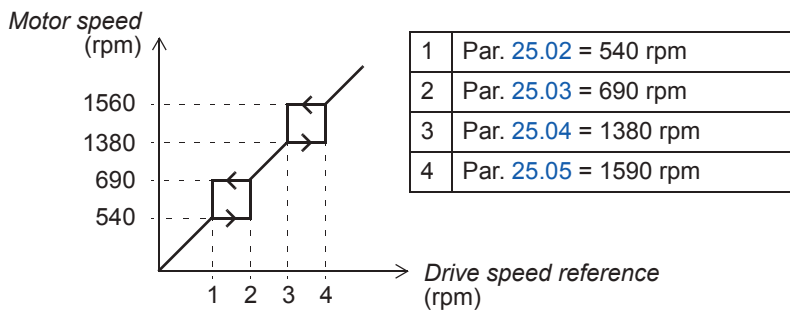

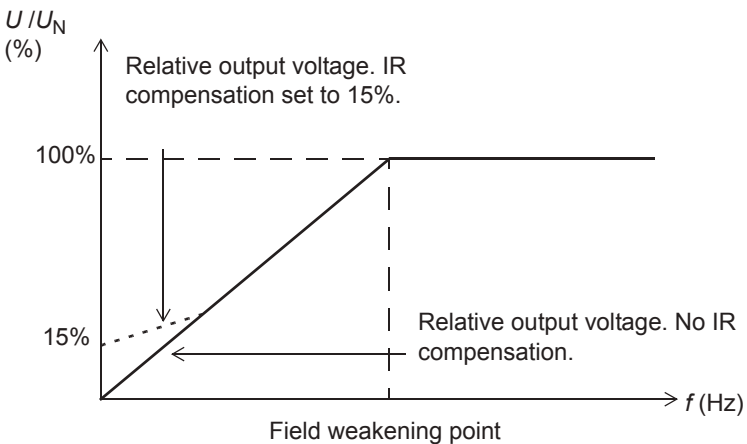
Index	Name/Selection	Description	FbEq
23.03	DERIVATION TIME	<p>Defines the derivation time for the speed controller. Derivative action boosts the controller output if the error value changes. The longer the derivation time, the more the speed controller output is boosted during the change. If the derivation time is set to zero, the controller works as a PI controller, otherwise as a PID controller.</p> <p>The derivation makes the control more responsive for disturbances.</p> <p>Note: Changing this parameter is recommended only if a pulse encoder is used.</p> <p>The figure below shows the speed controller output after an error step when the error remains constant.</p> <div style="text-align: right; margin-right: 50px;"> <p>Gain = $K_p = 1$ T_I = Integration time > 0 T_D = Derivation time > 0 T_s = Sample time period = 1 ms Δe = Error value change between two samples</p> </div> 	
	0.0 ... 9999.8 ms	Derivation time value.	1 = 1 ms
23.04	ACC COMPENSATION	<p>Defines the derivation time for acceleration/(deceleration) compensation. In order to compensate inertia during acceleration a derivative of the reference is added to the output of the speed controller. The principle of a derivative action is described for parameter 23.03.</p> <p>Note: As a general rule, set this parameter to the value between 50 and 100% of the sum of the mechanical time constants of the motor and the driven machine. (The speed controller Autotune Run does this automatically, see parameter 23.06.)</p> <p>The figure below shows the speed responses when a high inertia load is accelerated along a ramp.</p> <div style="display: flex; justify-content: space-around;"> <div style="text-align: center;"> <p>No Acceleration Compensation</p>  </div> <div style="text-align: center;"> <p>Acceleration Compensation</p>  </div> </div>	
	0.00 ... 999.98 s	Derivation time	0 ... 9999

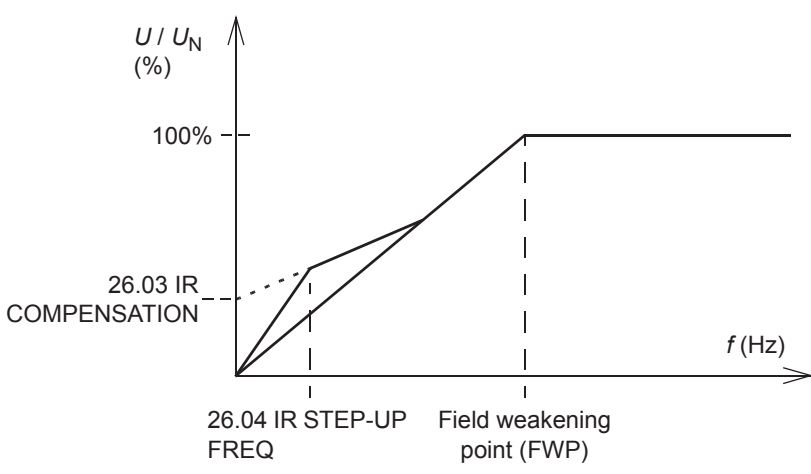

Index	Name/Selection	Description	FbEq
23.05	SLIP GAIN	Defines the slip gain for the motor slip compensation control. 100% means full slip compensation; 0% means no slip compensation. The default value is 100%. Other values can be used if a static speed error is detected despite of the full slip compensation. Example: 1000 rpm constant speed reference is given to the drive. Despite of the full slip compensation (SLIP GAIN = 100%), a manual tachometer measurement from the motor axis gives a speed value of 998 rpm. The static speed error is 1000 rpm - 998 rpm = 2 rpm. To compensate the error, the slip gain should be increased. At the 106% gain value, no static speed error exists.	
	0.0 ... 400.0%	Slip gain value.	0 ... 400
23.06	AUTOTUNE RUN	Start automatic tuning of the speed controller. Instructions: - Run the motor at a constant speed of 20 to 40% of the rated speed. - Change the autotuning parameter 23.06 to YES. Note: The motor load must be connected to the motor.	
	NO	No autotuning.	0
	YES	Activates the speed controller autotuning. Automatically reverts to NO.	65535
23.07	SP ACT FILT TIME	Defines the time constant of the actual speed filter, i.e. time within the actual speed has reached 63% of the nominal speed.	
	0...1000000 ms	Time constant	1 = 1 ms
24 TORQUE CTRL		Torque control variables. Visible only if parameter 99.02 = T CNTRL and parameter 99.04 = DTC.	
24.01	TORQ RAMP UP	Defines the torque reference ramp up time.	
	0.00 ... 120.00 s	Time for the reference to increase from zero to the nominal motor torque.	0 ... 12000
24.02	TORQ RAMP DOWN	Defines the torque reference ramp down time.	
	0.00 ... 120.00 s	Time for the reference to decrease from the nominal motor torque to zero.	0 ... 12000
25 CRITICAL SPEEDS		Speed bands within which the drive is not allowed to operate. See section Critical speeds on page 59.	
25.01	CRIT SPEED SELECT	Activates/deactivates the critical speeds function. Example: A fan has vibrations in the range of 540 to 690 rpm and 1380 to 1560 rpm. To make the drive to jump over the vibration speed ranges: - activate the critical speeds function, - set the critical speed ranges as in the figure below.  Note: If parameter 99.02 = PID CTRL, the critical speeds are not in use.	
	OFF	Inactive	0
	ON	Active.	65535

Index	Name/Selection	Description	FbEq
25.02	CRIT SPEED 1 LOW	Defines the minimum limit for critical speed range 1.	
	0 ... 18000 rpm	Minimum limit. The value cannot be above the maximum (parameter 25.03). Note: If parameter 99.04 = SCALAR, the unit is Hz.	0 ... 18000
25.03	CRIT SPEED 1 HIGH	Defines the maximum limit for critical speed range 1.	
	0 ... 18000 rpm	Maximum limit. The value cannot be below the minimum (parameter 25.02). Note: If parameter 99.04 = SCALAR, the unit is Hz.	0 ... 18000
25.04	CRIT SPEED 2 LOW	See parameter 25.02.	
	0 ... 18000 rpm	See parameter 25.02.	0 ... 18000
25.05	CRIT SPEED 2 HIGH	See parameter 25.03.	
	0 ... 18000 rpm	See parameter 25.03.	0 ... 18000
25.06	CRIT SPEED 3 LOW	See parameter 25.02.	
	0 ... 18000 rpm	See parameter 25.02.	0 ... 18000
25.07	CRIT SPEED 3 HIGH	See parameter 25.03.	
	0 ... 18000 rpm	See parameter 25.03.	0 ... 18000
26 MOTOR CONTROL			
26.01	FLUX OPTIMIZATION	Activates/deactivates the flux optimisation function. See section <i>Flux Optimisation</i> on page 58. Note: The function cannot be used if parameter 99.04 = SCALAR.	
	NO	Inactive	0
	YES	Active	65535
26.02	FLUX BRAKING	Activates/deactivates the flux braking function. Note: The function cannot be used if parameter 99.04 = SCALAR. See section <i>Flux Braking</i> on page 57.	
	NO	Inactive	0
	YES	Active	65535
26.03	IR-COMPENSATION	Defines the relative output voltage boost at zero speed (IR compensation). The function is useful in applications with high break-away torque, but no DTC motor control cannot be applied. The figure below illustrates the IR compensation. See section <i>IR compensation for a scalar controlled drive</i> on page 62. Note: The function can be used only if parameter 99.04 is SCALAR.	
		 <p>The graph plots relative output voltage U/U_N (%) on the y-axis against frequency f (Hz) on the x-axis. A solid line represents the voltage with 15% IR compensation, starting at 15% at zero frequency and reaching 100% at the field weakening point. A dashed line represents the voltage without IR compensation, starting at 0% at zero frequency and reaching 100% at the field weakening point. The field weakening point is marked on the x-axis.</p>	
	0 ... 30%	Voltage boost at zero speed in percent of the motor nominal voltage	0 ... 3000

Index	Name/Selection	Description	FbEq
26.04	IR STEP-UP FREQ	<p>Defines the frequency at which the step-up IR compensation reaches the IR compensation used in scalar control (26.03 IR COMPENSATION).</p> <p>A voltage boost is used in step-up applications to achieve higher break-away torque. Since voltage cannot be fed to the transformer at 0 Hz, special IR compensation is used in step-up applications. Full IR compensation starts around slip frequency. The figure below illustrates the step-up IR compensation.</p>  <p>For more information, see the <i>Sine Filters User's Manual for ACS800 Drives</i> [3AFE68389178 (English)].</p>	100 = 1
	0...50 Hz	Frequency	
26.05	HEX FIELD WEAKEN	Selects whether motor flux is controlled along a circular or a hexagonal pattern in the field weakening area of the frequency range (above 50/60 Hz). See section Hexagonal motor flux on page 63.	
	OFF	The rotating flux vector follows a circular pattern. Optimal selection in most applications: Minimal losses at constant load. Maximal instantaneous torque is not available in the field weakening range of the speed.	0
	ON	Motor flux follows a circular pattern below the field weakening point (typically 50 or 60 Hz) and a hexagonal pattern in the field weakening range. Optimal selection in the applications that require maximal instantaneous torque in the field weakening range of the speed. The losses at constant operation are higher than with the selection NO.	65535
26.06	FLUX REF PTR	Selects the source for the flux reference, or sets the flux reference value.	
	-255.255.31 ... +255.255.31 / C.- 32768 ... C.32767	Parameter index or a constant value. See parameter 10.04 for information on the difference. The range of the flux is 25 ... 140%. With constant value settings 100% = C.10000. Typically there is no need to change this value.	100 = 1%
26.07	FLYSTART CUR REF [%]	<p>Defines the current reference used with flying start (start to a rotating motor) when no pulse encoder is used.</p> <p>If flying start fails (i.e. drive is unable to detect motor speed 01.02 SPEED): Monitor signals 01.02 SPEED and 01.04 CURRENT with DriveWindow PC tool and increase the reference in steps of 5% until the flying start function is successfully performed (i.e. drive is able to detect 01.02 SPEED). See also parameter 26.08 FLYSTART INIT DLY.</p>	1 = 1%
	0...100%	Value in percent	

Index	Name/Selection	Description	FbEq
26.08	FLYSTART INIT DLY	Defines together with the motor characteristics the delay before the speed value estimated at the beginning of flying start is connected to the speed reference ramp output. Increase the delay, if the motor starts to rotate in the wrong direction or if the motor starts to rotate with the wrong speed reference. See also parameter 26.07 FLYSTART CUR REF [%].	1 = 1
	0...60	Delay	
26.09	FS METHOD	Activates the flux correction at low frequencies, < 3 Hz, when the torque exceeds 30%. Effective in the motoring and generating modes.	1 = 1
	1 = ON	Active	
	0 = OFF	Inactive	
27 BRAKE CHOPPER		Control of the brake chopper.	
27.01	BRAKE CHOPPER CTL	Activates the brake chopper control. Note: If an external chopper (e.g. NBRA-xxx) is used, parameter must be disabled.	
	OFF	Inactive	0
	ON	Active. Note: Ensure the brake chopper and resistor are installed and the overvoltage control is switched off (parameter 20.05).	65535
27.02	BR OVERLOAD FUNC	Activates the overload protection of the brake resistor. The user-adjustable variables are parameters 27.04 and 27.05.	
	NO	Inactive	0
	WARNING	Active. If the drive detects an overload, it generates a warning.	1
	FAULT	Active. If the drive detects an overload, it trips on a fault.	2
27.03	BR RESISTANCE	Defines the resistance value of the brake resistor. The value is used for brake chopper protection.	
	0.00 ... 100.00 ohm	Resistance value	0 ... 100
27.04	BR THERM TCONST	Defines the thermal time constant of the brake resistor. The value is used in the overload protection. See parameter 27.02. With type SACE brake resistors, the parameter setting must be 200 s. With type SAFUR brake resistors, the parameter setting must be 555 s.	
	0.000 ... 10000.000 s	Time constant	1 = 1
27.05	MAX CONT BR POWER	Defines the maximum continuous braking power which will raise the resistor temperature to the maximum allowed value. The value is used in the overload protection. See parameter 27.02.	
	0.00 ... 10000 kW	Power	1 = 1
27.06	BC CTRL MODE	Selects the control mode of the braking chopper.	
	AS GENERATOR	Chopper operation is allowed when the DC voltage exceeds the braking limit, the inverter bridge modulates and the motor generates power to the drive. The selection prevents the operation in case the intermediate circuit DC voltage rises due to abnormally high supply voltage level. Long time supply voltage rise would damage the chopper.	0
	COMMON DC	Chopper operation is allowed always when the DC voltage exceeds the braking limit. The selection is to be used in applications where several inverters are connected to the same intermediate circuit (DC bus).  WARNING! Excessive supply voltage will raise the intermediate circuit voltage above the operation limit of the chopper. If the voltage remains abnormally high for a long period, the braking chopper will be overloaded and damaged.	65535

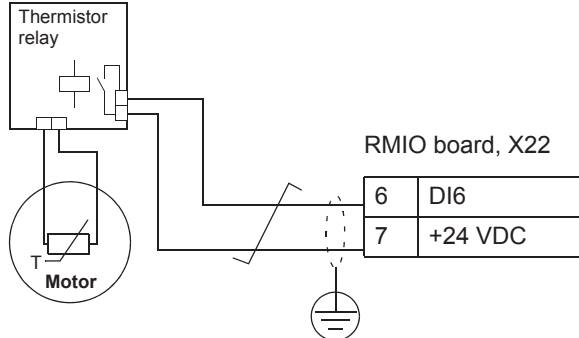
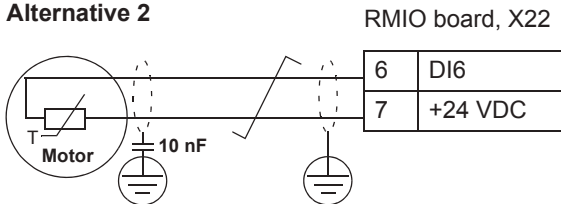

Index	Name/Selection	Description	FbEq
30 FAULT FUNCTIONS		Programmable protection functions	
30.01	AI<MIN FUNCTION	Selects how the drive reacts when an analogue input signal falls below the set minimum limit. Note: The analogue input minimum setting must be set to 0.5 V (1 mA) or above (see parameter group 13 ANALOGUE INPUTS).	
	FAULT	The drive trips on a fault and the motor coasts to stop.	1
	NO	Inactive	2
	CONST SP 15	The drive generates a warning AI < MIN FUNC (8110) and sets the speed to the value defined by parameter 12.16 .  WARNING! Make sure that it is safe to continue operation in case the analogue input signal is lost.	3
	LAST SPEED	The drive generates a warning AI < MIN FUNC (8110) and freezes the speed to the level the drive was operating at. The speed is determined by the average speed over the previous 10 seconds.  WARNING! Make sure that it is safe to continue operation in case the analogue input signal is lost.	4
30.02	PANEL LOSS	Selects how the drive reacts to a control panel communication break.	
	FAULT	Drive trips on a fault and the motor coasts to a stop.	1
	CONST SP 15	The drive generates a warning and sets the speed to the speed defined by parameter 12.16 .  WARNING! Make sure that it is safe to continue operation in case of a panel communication break.	2
	LAST SPEED	The drive generates a warning and freezes the speed to the level the drive was operating at. The speed is determined by the average speed over the previous 10 seconds.  WARNING! Make sure that it is safe to continue operation in case of a panel communication break.	3
30.03	EXTERNAL FAULT	Selects an interface for an external fault signal. See section External Fault on page 63 .	
	NOT SEL	Inactive	1
	DI1	External fault indication is given through digital input DI1. 0: Fault trip. Motor coasts to stop. 1: No external fault.	2
	DI2	See selection DI1 .	3
	DI3	See selection DI1 .	4
	DI4	See selection DI1 .	5
	DI5	See selection DI1 .	6
	DI6	See selection DI1 .	7
	DI7	See selection DI1 .	8
	DI8	See selection DI1 .	9
	DI9	See selection DI1 .	10
	DI10	See selection DI1 .	11
	DI11	See selection DI1 .	12
	DI12	See selection DI1 .	13

Index	Name/Selection	Description	FbEq
30.04	MOTOR THERM PROT	Selects how the drive reacts when the motor overtemperature is detected by the function defined by parameter 30.05. See section <i>Motor Thermal Protection</i> on page 64.	
	FAULT	The drive generates a warning when the temperature exceeds the warning level (95% of the allowed maximum value). The drive trips on a fault when the temperature exceeds the fault level (100% of the allowed maximum value).	1
	WARNING	The drive generates a warning when the temperature exceeds the warning level (95% of the allowed maximum value).	2
	NO	Inactive	3
30.05	MOT THERM P MODE	Selects the thermal protection mode of the motor. When overtemperature is detected, the drive reacts as defined by parameter 30.04.	
	DTC	<p>The protection is based on the calculated motor thermal model. The following assumptions are used in the calculation:</p> <ul style="list-style-type: none"> - The motor is at the estimated temperature (value of 01.37 MOTOR TEMP EST saved at power switch off) when the power is switched on. With the first power switch on, the motor is at the ambient temperature (30°C). - The motor temperature increases if it operates in the region above the load curve. - The motor temperature decreases if it operates in the region below the curve. This applies only if the motor is overheated. - The motor thermal time constant is an approximate value for a standard self-ventilated squirrel-cage motor. <p>It is possible to finetune the model by parameter 30.07.</p> <p>Note: The model cannot be used with high power motors (parameter 99.06 is higher than 800 A).</p> <p> WARNING! The model does not protect the motor if it does not cool properly due to dust and dirt.</p>	1
	USER MODE	<p>The protection is based on the user-defined motor thermal model and the following basic assumptions:</p> <ul style="list-style-type: none"> - The motor is at the estimated temperature (value of 01.37 MOTOR TEMP EST saved at power switch off) when the power is switched on. With the first power switch on, the motor is at the ambient temperature (30°C). - The motor temperature increases if it operates in the region above the motor load curve. - The motor temperature decreases if it operates in the region below the curve. This applies only if the motor is overheated. <p>The user-defined thermal model uses the motor thermal time constant (parameter 30.06) and the motor load curve (parameters 30.07, 30.08 and 30.09). User tuning is typically needed only if the ambient temperature differs from the normal operating temperature specified for the motor.</p> <p> WARNING! The model does not protect the motor if it does not cool properly due to dust and dirt.</p>	2

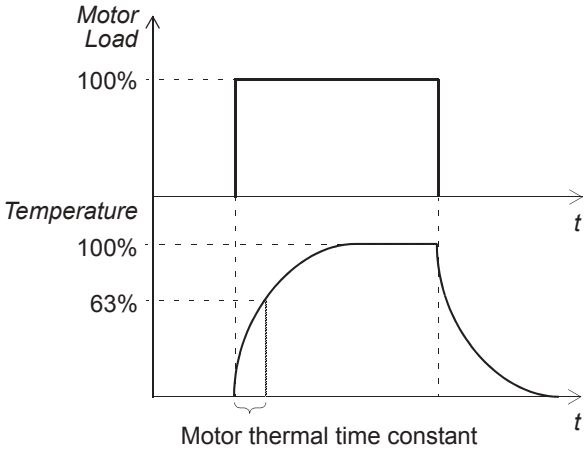
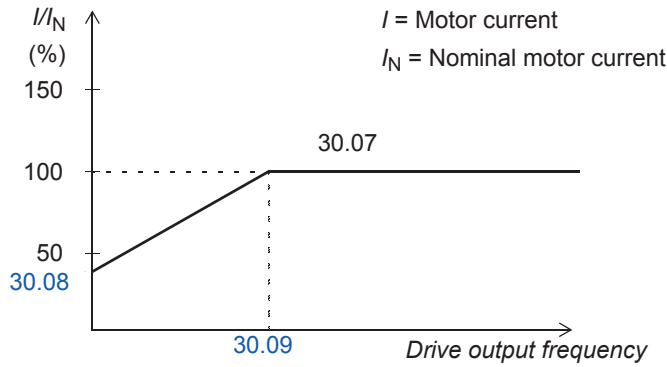
Index	Name/Selection	Description	FbEq						
	TEMP SENSOR	<p>Motor thermal protection is activated through digital input DI6. A motor thermistor, or a break contact of a thermistor relay, must be connected to digital input DI6. The drive reads the DI6 states as follows:</p> <table border="1" data-bbox="464 414 1209 544"> <thead> <tr> <th>DI6 Status (Thermistor resistance)</th> <th>Temperature</th> </tr> </thead> <tbody> <tr> <td>1 (0 ... 1.5 kohm)</td> <td>Normal</td> </tr> <tr> <td>0 (4 kohm or higher)</td> <td>Overtemperature</td> </tr> </tbody> </table> <p>⚡ WARNING! According to IEC 664, the connection of the motor thermistor to the digital input requires double or reinforced insulation between motor live parts and the thermistor. Reinforced insulation entails a clearance and creeping distance of 8 mm (400 / 500 VAC equipment). If the thermistor assembly does not fulfil the requirement, the other I/O terminals of the drive must be protected against contact, or a thermistor relay must be used to isolate the thermistor from the digital input.</p> <p>⚠ WARNING! Digital input DI6 may be selected for another use. Change these settings before selecting TEMP SENSOR. In other words, ensure that digital input DI6 is not selected by any other parameter.</p> <p>The figure below shows the alternative thermistor connections. At the motor end the cable shield should be earthed through a 10 nF capacitor. If this is not possible, the shield is to be left unconnected.</p> <p>Alternative 1</p>  <p>Alternative 2</p>  <p>Note: If the motor nominal current is above 800 A, the user defined motor thermal model is used instead of the calculated model and the user must define parameters 30.06, 30.07, 30.08 and 30.09.</p>	DI6 Status (Thermistor resistance)	Temperature	1 (0 ... 1.5 kohm)	Normal	0 (4 kohm or higher)	Overtemperature	3
DI6 Status (Thermistor resistance)	Temperature								
1 (0 ... 1.5 kohm)	Normal								
0 (4 kohm or higher)	Overtemperature								

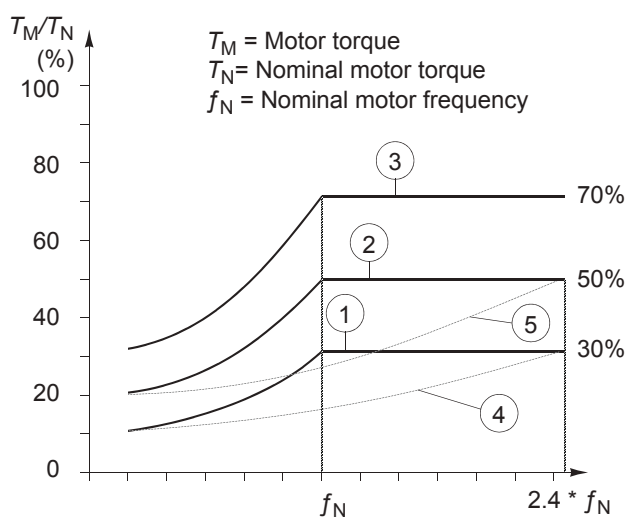
Index	Name/Selection	Description	FbEq
30.06	MOTOR THERM TIME	<p>Defines the thermal time constant for the user-defined thermal model (see the selection USER MODE of parameter 30.05).</p>  <p style="text-align: center;">Motor thermal time constant</p>	
	256.0 ... 9999.8 s	Time constant	256 ... 9999
30.07	MOTOR LOAD CURVE	<p>Defines the load curve together by parameters 30.08 and 30.09. The load curve is used in the user-defined thermal model (see the selection USER MODE of parameter 30.05).</p>  <p style="text-align: center;">$I =$ Motor current $I_N =$ Nominal motor current</p>	
	50.0 ... 150.0%	Allowed continuous motor load in percent of the nominal motor current.	50 ... 150
30.08	ZERO SPEED LOAD	Defines the load curve together with parameters 30.07 and 30.09.	
	25.0 ... 150.0%	Allowed continuous motor load at zero speed in percent of the nominal motor current	25 ... 150
30.09	BREAK POINT	Defines the load curve together with parameters 30.07 and 30.08.	
	1.0 ... 300.0 Hz	Drive output frequency at 100% load	100 ... 30000

Index	Name/Selection	Description	FbEq
30.10	STALL FUNCTION	<p>Selects how the drive reacts to a motor stall condition. The protection wakes up if:</p> <ul style="list-style-type: none"> - the drive is at stall limit (defined by parameters 20.03, 20.13 and 20.14) - the output frequency is below the level set by parameter 30.11 and - the conditions above have been valid longer than the time set by parameter 30.12. <p>Note: Stall limit is restricted by internal current limit 03.04 TORQ_INV_CUR_LIM.</p> <p>See section <i>Stall Protection</i> on page 65.</p>	
	FAULT	The drive trips on a fault.	1
	WARNING	The drive generates a warning. The indication disappears in half of the time set by parameter 30.12.	2
	NO	Protection is inactive.	3
30.11	STALL FREQ HI	Defines the frequency limit for the stall function. See parameter 30.10.	
	0.5 ... 50.0 Hz	Stall frequency	50 ... 5000
30.12	STALL TIME	Defines the time for the stall function. See parameter 30.10.	
	10.00 ... 400.00 s	Stall time	10 ... 400
30.13	UNDERLOAD FUNC	<p>Selects how the drive reacts to underload. The protection wakes up if:</p> <ul style="list-style-type: none"> - the motor torque falls below the curve selected by parameter 30.15, - output frequency is higher than 10% of the nominal motor frequency and - the above conditions have been valid longer than the time set by parameter 30.14. <p>See section <i>Underload Protection</i> on page 65.</p>	
	NO	Protection is inactive.	1
	WARNING	The drive generates a warning.	2
	FAULT	The drive trips on a fault.	3
30.14	UNDERLOAD TIME	Time limit for the underload function. See parameter 30.13.	
	0 ... 600 s	Underload time	0 ... 600
30.15	UNDERLOAD CURVE	<p>Selects the load curve for the underload function. See parameter 30.13.</p>  <p> T_M = Motor torque T_N = Nominal motor torque f_N = Nominal motor frequency </p>	
	1 ... 5	Number of the load curve	1 ... 5

Index	Name/Selection	Description	FbEq
30.16	MOTOR PHASE LOSS	Activates the motor phase loss supervision function. See section Motor Phase Loss on page 65.	
	NO	Inactive	0
	FAULT	Active. The drive trips on a fault.	65535
30.17	EARTH FAULT	Selects how the drive reacts when an earth fault is detected in the motor or the motor cable. See section Earth Fault Protection on page 66. Note: With parallel connected R8i inverter modules (ACS800 multidrive and large ACS800-07 units) only the selection FAULT is valid.	
	WARNING	The drive generates a warning.	0
	FAULT	The drive trips on a fault.	65535
30.18	COMM FLT FUNC	Selects how the drive reacts in a fieldbus communication break, i.e. when the drive fails to receive the Main Reference Data Set or the Auxiliary Reference Data Set. The time delays are given by parameters 30.19 and 30.21.	
	FAULT	Protection is active. The drive trips on a fault and the motor coasts to a stop.	1
	NO	Protection is inactive.	2
	CONST SP 15	Protection is active. The drive generates a warning and sets the speed to the value defined by parameter 12.16.  WARNING! Make sure that it is safe to continue operation in case of a communication break.	3
	LAST SPEED	Protection is active. The drive generates a warning and freezes the speed to the level the drive was operating at. The speed is determined by the average speed over the previous 10 seconds.  WARNING! Make sure that it is safe to continue operation in case of a communication break.	4
30.19	MAIN REF DS T-OUT	Defines the time delay for the Main Reference data set supervision. See parameter 30.18.	
	0.1 ... 60.0 s	Time delay	10 ... 6000
30.20	COMM FLT RO/AO	Selects the operation of the fieldbus controlled relay output and analogue output in a communication break. See groups 14 RELAY OUTPUTS and 15 ANALOGUE OUTPUTS and chapter Fieldbus control . The delay for the supervision function is given by parameter 30.21.	
	ZERO	Relay output is de-energised. Analogue output is set to zero.	0
	LAST VALUE	The relay output keeps the last state before the communication loss. The analogue output gives the last value before the communication loss.  WARNING! After the communication recovers, the update of the relay and the analogue outputs starts immediately without fault message resetting.	65535
30.21	AUX DS T-OUT	Defines the delay time for the Auxiliary Reference data set supervision. See parameter 30.18. The drive automatically activates the supervision 60 seconds after power switch-on if the value is other than zero. Note: The delay also applies for the function defined by parameter 30.20.	
	0.0 ... 60.0 s	Time delay. 0.0 s = The function is inactive.	0 ... 6000

Index	Name/Selection	Description	FbEq
30.22	IO CONFIG FUNC	Selects how the drive reacts in case an optional input or output channel has been selected as a signal interface, but the communication to the appropriate analogue or digital I/O extension module has not been set up accordingly in parameter group 98 OPTION MODULES . Example: The supervision function wakes up if parameter 16.01 is set to DI7, but 98.03 is set to NO.	
	NO	Inactive.	1
	WARNING	Active. The drive generates a warning.	2
30.23	LIMIT WARNING	Activates/deactivates limit alarms INV CUR LIM, DC BUS LIM, MOT CUR LIM, MOT TORQ LIM and/or MOT POW LIM. For more information, see chapter Fault tracing .	
	0...255	Value in decimal. As default none of the alarms are active, i.e. parameter value is 0. bit 0 INV_CUR_LIM_IND bit 1 DC_VOLT_LIM_IND bit 2 MOT_CUR_LIM_IND bit 3 MOT_TORQ_LIM_IND bit 4 MOT_POW_LIM_IND Example: When parameter value is set to 3 (bit 0 and 1 values are 1), alarms INV CUR LIM and DC BUS LIM are active.	-
31 AUTOMATIC RESET		Automatic fault reset. Automatic resets are possible only for certain fault types and when the automatic reset function is activated for that fault type. The automatic reset function is not operational if the drive is in local control (L visible on the first row of the panel display). See section Automatic resets on page 69 .	
31.01	NUMBER OF TRIALS	Defines the number of automatic fault resets the drive performs within the time defined by parameter 31.02 .	
	0 ... 5	Number of the automatic resets	0
31.02	TRIAL TIME	Defines the time for the automatic fault reset function. See parameter 31.01 .	
	1.0 ... 180.0 s	Allowed resetting time	100 ... 18000
31.03	DELAY TIME	Defines the time that the drive will wait after a fault before attempting an automatic reset. See parameter 31.01 .	
	0.0 ... 3.0 s	Resetting delay	0 ... 300
31.04	OVERCURRENT	Activates/deactivates the automatic reset for the overcurrent fault.	
	NO	Inactive	0
	YES	Active	65535
31.05	OVERVOLTAGE	Activates/deactivates the automatic reset for the intermediate link overvoltage fault.	
	NO	Inactive	0
	YES	Active	65535
31.06	UNDERVOLTAGE	Activates/deactivates the automatic reset for the intermediate link undervoltage fault.	
	NO	Inactive	0
	YES	Active	65535
31.07	AI SIGNAL<MIN	Activates/deactivates the automatic reset for the fault AI SIGNAL<MIN (analogue input signal under the allowed minimum level).	

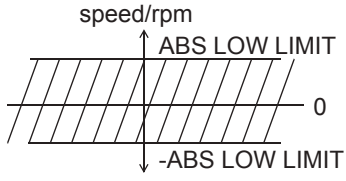
Index	Name/Selection	Description	FbEq
	NO	Inactive	0
	YES	Active.  WARNING! The drive may restart even after a long stop if the analogue input signal is restored. Ensure that the use of this feature will not cause danger.	65535
31.08	LINE CONV	Activates/deactivates the automatic reset for the fault LINE CONV (FF51) (fault on line side converter).	
	NO	Inactive	0
	YES	Active	65535
32 SUPERVISION		Supervision limits. A relay output can be used to indicate when the value is above/below the limit. See section Supervisions on page 69.	
32.01	SPEED1 FUNCTION	Activates/deactivates the speed supervision function and selects the type of the supervision limit.	
	NO	Supervision is not used.	1
	LOW LIMIT	Supervision wakes up if the value is below the limit.	2
	HIGH LIMIT	Supervision wakes up if the value is above the limit.	3
	ABS LOW LIMIT	Supervision wakes up if the value is below the set limit. The limit is supervised in both rotating directions. The figure below illustrates the principle. 	4
32.02	SPEED1 LIMIT	Defines the speed supervision limit. See parameter 32.01.	
	- 18000 ... 18000 rpm	Value of the limit	- 18000 ... 18000
32.03	SPEED2 FUNCTION	See parameter 32.01.	
	NO	See parameter 32.01.	1
	LOW LIMIT	See parameter 32.01.	2
	HIGH LIMIT	See parameter 32.01.	3
	ABS LOW LIMIT	See parameter 32.01.	4
32.04	SPEED2 LIMIT	See parameter 32.01.	
	- 18000 ... 18000 rpm	See parameter 32.01.	- 18000 ... 18000
32.05	CURRENT FUNCTION	Activates/deactivates the motor current supervision function and selects the type of the supervision limit.	
	NO	See parameter 32.01.	1
	LOW LIMIT	See parameter 32.01.	2
	HIGH LIMIT	See parameter 32.01.	3
32.06	CURRENT LIMIT	Defines the limit for the motor current supervision (see parameter 32.05).	
	0 ... 1000 A	Value of the limit	0 ... 1000
32.07	TORQUE 1 FUNCTION	Activates/deactivates the motor torque supervision function and selects the type of the supervision limit.	
	NO	See parameter 32.01.	1
	LOW LIMIT	See parameter 32.01.	2

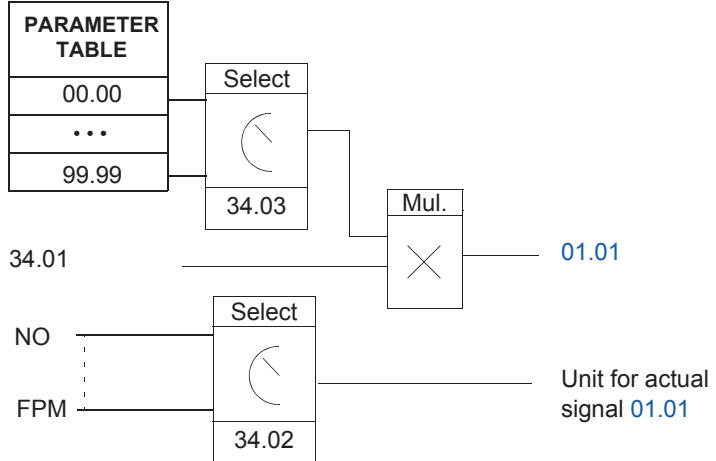

Index	Name/Selection	Description	FbEq
	HIGH LIMIT	See parameter 32.01.	3
32.08	TORQUE 1 LIMIT	Defines the limit for the motor torque supervision (see parameter 32.07).	
	-600 ... 600%	Value of the limit in percent of the motor nominal torque	-6000 ... 6000
32.09	TORQUE 2 FUNCTION	Activates/deactivates the motor torque supervision function and selects the type of the supervision limit.	
	NO	See parameter 32.01.	1
	LOW LIMIT	See parameter 32.01.	2
	HIGH LIMIT	See parameter 32.01.	3
32.10	TORQUE 2 LIMIT	Defines the limit for the motor torque supervision (see parameter 32.09).	
	-600 ... 600%	Value of the limit in percent of motor nominal torque	-6000 ... 6000
32.11	REF1 FUNCTION	Activates/deactivates the external reference REF1 supervision function and selects the type of the supervision limit.	
	NO	See parameter 32.01.	1
	LOW LIMIT	See parameter 32.01.	2
	HIGH LIMIT	See parameter 32.01.	3
32.12	REF1 LIMIT	Defines the limit for REF1 supervision (see parameter 32.11).	
	0 ... 18000 rpm	Value of the limit	0 ... 18000
32.13	REF2 FUNCTION	Activates/deactivates external reference REF2 supervision function and selects the type of the supervision limit.	
	NO	See parameter 32.01.	1
	LOW LIMIT	See parameter 32.01.	2
	HIGH LIMIT	See parameter 32.01.	3
32.14	REF2 LIMIT	Defines the limit for REF2 supervision (see parameter 32.13).	
	0 ... 600%	Value of the limit	0 ... 6000
32.15	ACT1 FUNCTION	Activates/deactivates the supervision function for variable ACT1 of the process PID controller and selects the type of the supervision limit.	
	NO	See parameter 32.01.	1
	LOW LIMIT	See parameter 32.01.	2
	HIGH LIMIT	See parameter 32.01.	3
32.16	ACT1 LIMIT	Defines the limit for ACT1 supervision (see parameter 32.15).	
	0 ... 200%	Value of the limit	0 ... 2000
32.17	ACT2 FUNCTION	Activates/deactivates the supervision function for variable ACT2 of the process PID controller and selects the type of the supervision limit.	
	NO	See parameter 32.01.	1
	LOW LIMIT	See parameter 32.01.	2
	HIGH LIMIT	See parameter 32.01.	3
32.18	ACT2 LIMIT	Defines the limit for ACT2 supervision (see parameter 32.17).	
	0 ... 200%	Value of the limit	0 ... 2000
33 INFORMATION		Program versions, test date	
33.01	SOFTWARE VERSION	Displays the type and the version of the firmware package in the drive. Note: Parameter setting cannot be changed by the user.	

Index	Name/Selection	Description	FbEq
		Decoding key: <div style="text-align: right; margin-right: 100px;">ASxxxxyx</div> Product Series _____ A = ACS800 _____ Product _____ S = ACS800 Standard _____ Firmware Version _____ 7xyx = Version 7.xyx	
33.02	APPL SW VERSION	Displays the type and the version of the application program. Note: Parameter setting cannot be changed by the user.	
		Decoding key: <div style="text-align: right; margin-right: 100px;">ASAxxxxyx</div> Product Series _____ A = ACS800 _____ Product _____ S = ACS800 Standard _____ Firmware Type _____ A = Application Program _____ Firmware Version _____ 7xyx = Version 7.xyx	
33.03	TEST DATE	Displays the test date. Note: Parameter setting cannot be changed by the user.	
		Date value in format DDMMYY (day, month, year)	-
33.04	BOARD TYPE	Shows the control board type. Note: RMIO-1x boards have different type of FLASH memory chips than RMIO-0x. Only software version ASXR7300 or later will operate with the RMIO-1x boards.	
34 PROCESS VARIABLE		- user variable and unit - filtering for the actual signals speed and torque - reset of the run time counter	
34.01	SCALE	Scales the selected drive variable into a desired user-defined variable, which is stored as an actual signal 01.01. The block diagram below illustrates the use of the parameters that define actual signal 01.01.	
			
	0.00...100000.00%	Scaling factor	0...100000

Index	Name/Selection	Description	FbEq
34.02	P VAR UNIT	Selects the unit for the process variable. See parameter 34.01 .	
	NO	No unit is selected.	1
	rpm	revolutions per minute	2
	%	percent	3
	m/s	metres per second	4
	A	ampere	5
	V	volt	6
	Hz	hertz	7
	s	second	8
	h	hour	9
	kh	kilohour	10
	C	celsius	11
	lft	pounds per foot	12
	mA	milliampere	13
	mV	millivolt	14
	kW	kilowatt	15
	W	watt	16
	kWh	kilowatt hour	17
	F	fahrenheit	18
	hp	horsepower	19
	MWh	megawatt hour	20
	m3h	cubic metres per hour	21
	l/s	litres per second	22
	bar	bar	23
	kPa	kilopascal	24
	GPM	gallons per minute	25
	PSI	pounds per square inch	26
	CFM	cubic feet per minute	27
	ft	foot	28
	MGD	millions of gallons per day	29
	iHg	inches of mercury	30
	FPM	feet per minute	31
	lbs	pound	32
34.03	SELECT P VAR	Selects the drive variable scaled into a desired process variable. See parameter 34.01 .	
	0 ... 9999	Parameter index	0 ... 9999
34.04	MOTOR SP FILT TIM	Defines a filter time constant for actual signal 01.02 SPEED . The time constant has an effect on all functions in which signal SPEED is used. The actual speed value is used e.g. in speed supervision (parameter group 32 SUPERVISION) as an analogue output value (group 15 ANALOGUE OUTPUTS) or as an actual signal shown on the control panel display or PC screen.	

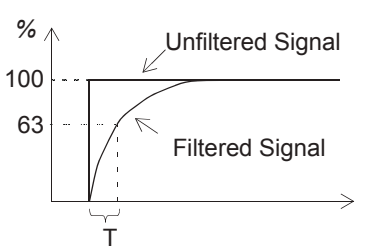
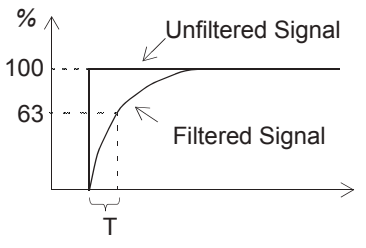
Index	Name/Selection	Description	FbEq
	0 ... 20000 ms	Filter time constant  $O = I \cdot (1 - e^{-t/T})$ <p> I = filter input (step) O = filter output t = time T = filter time constant </p>	0 ... 20000
34.05	TORQ ACT FILT TIM	Defines a filter time for the actual signal torque (actual signal 01.05). Affects also on the torque supervision (parameters 32.07 and 32.09) and the torque read through an analogue output.	
	0 ... 20000 ms	Filter time constant  $O = I \cdot (1 - e^{-t/T})$ <p> I = filter input (step) O = filter output t = time T = filter time constant </p>	0 ... 20000
34.06	RESET RUN TIME	Resets the motor running time counter (actual signal 01.43).	
	NO	No reset.	0
	YES	Reset. The counter restarts from zero.	65535
35 MOT TEMP MEAS		Motor temperature measurement. For the function description see sections Motor temperature measurement through the standard I/O on page 73 and Motor temperature measurement through an analogue I/O extension on page 75.	
35.01	MOT 1 TEMP AI1 SEL	Activates the motor 1 temperature measurement function and selects the sensor type. Note: If an optional analogue I/O extension module RAIO is used for the temperature measurement and 35.01 MOT 1 TEMP AI1 SEL and/or 35.04 MOT 2 TEMP AI2 SEL are set to 1xPT100, analogue extension module input signal range must be set to 0...2 V (instead of 0...10 V) with DIP switches.	
	NOT IN USE	The function is inactive.	1
	1xPT100	The function is active. The temperature is measured with one Pt 100 sensor. Analogue output AO1 feeds constant current through the sensor. The sensor resistance increases as the motor temperature rises, as does the voltage over the sensor. The temperature measurement function reads the voltage through analogue input AI1 and converts it to degrees centigrade.	2
	2XPT100	The function is active. Temperature is measured using two Pt 100 sensors. See selection 1xPT100.	3
	3XPT100	The function is active. Temperature is measured using three Pt 100 sensors. See selection 1xPT100.	4

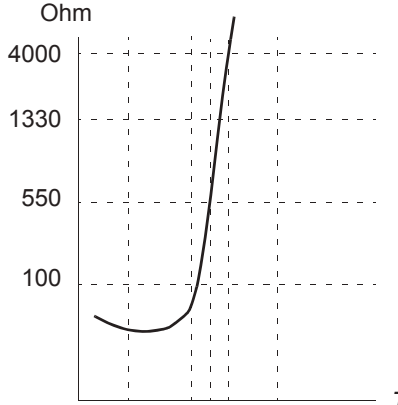
Index	Name/Selection	Description	FbEq						
	1...3 PTC	<p>The function is active. The temperature is supervised using one to three PTC sensors or one to three KTY84-1xx silicon temperature sensors. Analogue output AO1 feeds constant current through the sensor(s). The resistance of the sensor increases sharply as the motor temperature rises over the sensor reference temperature (T_{ref}), as does the voltage over the resistor. The temperature measurement function reads the voltage through analogue input AI1 and converts it into ohms. The figure below shows typical PTC sensor resistance values as a function of the motor operating temperature.</p> <table border="1"> <thead> <tr> <th>Temperature</th> <th>Resistance</th> </tr> </thead> <tbody> <tr> <td>Normal</td> <td>0 ... 1.5 kohm</td> </tr> <tr> <td>Excessive</td> <td>≥ 4 kohm</td> </tr> </tbody> </table> 	Temperature	Resistance	Normal	0 ... 1.5 kohm	Excessive	≥ 4 kohm	5
Temperature	Resistance								
Normal	0 ... 1.5 kohm								
Excessive	≥ 4 kohm								
35.02	MOT 1 TEMP ALM L	Defines the alarm limit for motor 1 temperature measurement. The alarm indication is given when the limit is exceeded.							
	-10 ... 5000 ohm/°C (PTC/Pt100)	Limit in °C or ohms. °C: parameter 35.01 is 1xPT100, 2XPT100, 3XPT100. Ohm: parameter 35.01 is 1...3 PTC.	-10 ... 5000						
35.03	MOT 1 TEMP FLT L	Defines the fault trip limit for motor 1 temperature measurement. The fault indication is given when the limit is exceeded.							
	-10 ... 5000 ohm/°C (PTC/Pt100)	Limit in °C or ohms. °C: parameter 35.01 is 1xPT100, 2XPT100, 3XPT100. Ohm: parameter 35.01 is 1...3 PTC.	-10 ... 5000						
35.04	MOT 2 TEMP AI2 SEL	<p>Activates the motor 2 temperature measurement function and selects the sensor type. Two motors can be protected only by using an optional analogue extension module. Parameter 98.12 needs to be activated.</p> <p>Note: If 98.12 is activated, the analogue I/O extension is also used for motor 1 temperature measurement (the standard I/O terminals are not in use).</p> <p>Note: If an optional analogue I/O extension module RAIO is used for the temperature measurement and 35.01 MOT 1 TEMP AI1 SEL and/or 35.04 MOT 2 TEMP AI2 SEL are set to 1xPT100, analogue extension module input signal range must be set to 0...2 V (instead of 0...10 V) with DIP switches.</p>							
	NOT IN USE	See 35.01.	1						
	1xPT100	See 35.01.	2						
	2XPT100	See 35.01.	3						
	3XPT100	See 35.01.	4						
	1...3 PTC	See 35.01.	5						
35.05	MOT 2 TEMP ALM L	Defines the alarm limit for the motor 2 temperature measurement function. The alarm indication is given when the limit is exceeded.							
	-10 ... 5000 ohm/°C (PTC/Pt100)	See 35.02.	-10 ... 5000						

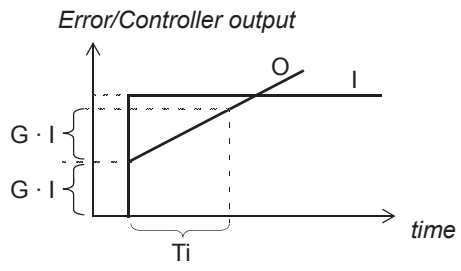
Index	Name/Selection	Description	FbEq												
35.06	MOT 2 TEMP FLT L	Defines the fault trip limit for the motor 2 temperature measurement function. The fault indication is given when the limit is exceeded.													
	-10 ... 5000 ohm/°C (PTC/Pt100)	See 35.03 .	-10 ... 5000												
35.07	MOT MOD COMPENSAT	Selects whether measured motor 1 temperature is used in the motor model compensation.													
	NO	The function is inactive.	1												
	YES	The temperature is used in the motor model compensation. Note: Selection is effective only when Pt 100 sensor(s) are used.	2												
	YES PAR35.08	Motor temperature is brought from the automation system to the drive.	3												
35.08	MOT MOD COMP PTR	The source for the motor temperature feedback when parameter 35.07 has been set to value YES PAR35.08.													
	-255.255.31 ... +255.255.31 / C.- 32768 ... C.32767	Parameter index or a constant value. Example: Connection pointer via 85.01 CONSTANT1: 35.08 MOT MOD COMP PTR = +.085.001.00.	-												
40 PID CONTROL		- process PID control (99.02 = PID CTRL) - speed or torque reference trimming (99.02 is not PID CTRL) - sleep function for the process PID control (99.02 = PID CTRL) For more information, see section Process PID control on page 70 .													
40.01	PID GAIN	Defines the gain of the process PID controller.													
	0.1 ... 100.0	Gain value. The table below lists a few examples of the gain settings and the resulting speed changes when - a 10% or 50% error value is connected to the controller (error = process reference - process actual value). - motor maximum speed is 1500 rpm (parameter 20.02)	10 ... 10000												
		<table border="1"> <thead> <tr> <th>PID Gain</th> <th>Speed Change: 10% Error</th> <th>Speed Change: 50% Error</th> </tr> </thead> <tbody> <tr> <td>0.5</td> <td>75 rpm</td> <td>375 rpm</td> </tr> <tr> <td>1.0</td> <td>150 rpm</td> <td>750 rpm</td> </tr> <tr> <td>3.0</td> <td>450 rpm</td> <td>1500 rpm (limited)</td> </tr> </tbody> </table>	PID Gain	Speed Change: 10% Error	Speed Change: 50% Error	0.5	75 rpm	375 rpm	1.0	150 rpm	750 rpm	3.0	450 rpm	1500 rpm (limited)	
PID Gain	Speed Change: 10% Error	Speed Change: 50% Error													
0.5	75 rpm	375 rpm													
1.0	150 rpm	750 rpm													
3.0	450 rpm	1500 rpm (limited)													
40.02	PID INTEG TIME	Defines the integration time for the process PID controller.													
		 <p>I = controller input (error) O = controller output G = gain t = time Ti = integration time</p>													
	0.02 ... 320.00 s	Integration time	2 ... 32000												

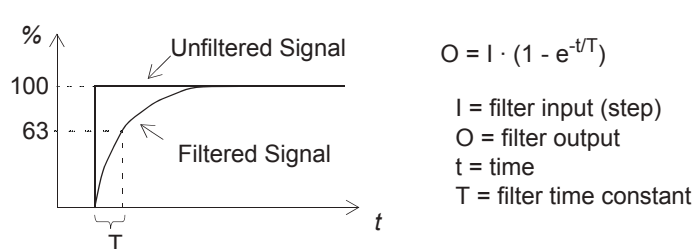
Index	Name/Selection	Description	FbEq
40.03	PID DERIV TIME	Defines the derivation time of the process PID controller. The derivative component at the controller output is calculated on basis of two consecutive error values (E_{K-1} and E_K) according to the following formula: $PID\ DERIV\ TIME \cdot (E_K - E_{K-1})/T_S$, in which $T_S = 12\ ms$ sample time. $E = Error = Process\ reference - process\ actual\ value$	
	0.00 ... 10.00 s	Derivation time.	0 ... 1000
40.04	PID DERIV FILTER	Defines the time constant of the 1-pole filter used to smooth the derivative component of the process PID controller.	
	0.04 ... 10.00 s	Filter time constant. 	4 ... 1000
40.05	ERROR VALUE INV	Inverts the error at the process PID controller input (error = process reference - process actual value).	
	NO	No inversion	0
	YES	Inversion. With sleep function, the drive operation is as follows: The drive enters the sleep mode when the motor speed is below the sleep level (02.02 < 40.21) and when the process PID control actual value is smaller than the wake-up level (01.34 < 40.23). The drive wakes up when the process PID actual value is greater than the wake-up level (01.34 > 40.23). See also section <i>Sleep function for the process PID control</i> on page 71.	65535
40.06	ACTUAL VALUE SEL	Selects the process actual value for the process PID controller: The sources for the variable ACT1 and ACT2 are further defined by parameters 40.07 and 40.08.	
	ACT1	ACT1	1
	ACT1-ACT2	Subtraction of ACT1 and ACT 2.	2
	ACT1+ACT2	Addition of ACT1 and ACT2	3
	ACT1*ACT2	Multiplication of ACT1 and ACT2	4
	ACT1/ACT2	Division of ACT1 and ACT2	5
	MIN(A1,A2)	Selects the smaller of ACT1 and ACT2	6
	MAX(A1,A2)	Selects the higher of ACT1 and ACT2	7
	sqrt(A1-A2)	Square root of the subtraction of ACT1 and ACT2	8
	sqA1+sqA2	Addition of the square root of ACT1 and the square root of ACT2	9
40.07	ACTUAL1 INPUT SEL	Selects the source for the variable ACT1. See parameter 40.06.	
	A11	Analogue input AI1	1
	A12	Analogue input AI2	2
	A13	Analogue input AI3	3
	A15	Analogue input AI5	4

Index	Name/Selection	Description	FbEq						
	AI6	Analogue input AI6	5						
	PARAM 40.25	Source selected by parameter 40.25.	6						
40.08	ACTUAL2 INPUT SEL	Selects the source for the variable ACT2. See parameter 40.06.							
	AI1	Analogue input AI1	1						
	AI2	Analogue input AI2	2						
	AI3	Analogue input AI3	3						
	AI5	Analogue input AI5	4						
	AI6	Analogue input AI6	5						
40.09	ACT1 MINIMUM	Defines the minimum value for the variable ACT1 if an analogue input is selected as a source for ACT1. See parameter 40.07. The minimum and maximum (40.10) settings of ACT1 define how the voltage/current signal received from the measuring device is converted to a percentage value used by the process PID controller.							
	-1000 ... 1000%	<p>Minimum value in percent of the set analogue input range. The equation below instructs how to calculate the value when analogue input AI1 is used as a variable ACT1.</p> $\text{ACT1 MINIMUM} = \frac{\text{AI1min} - 13.01}{13.02 - 13.01} \cdot 100\%$ <table border="1" data-bbox="534 996 1356 1176"> <tr> <td>AI1min</td> <td>The voltage value received from the measuring device when the measured process actual value is at the desired minimum level.</td> </tr> <tr> <td>13.01</td> <td>AI1 minimum (parameter setting)</td> </tr> <tr> <td>13.02</td> <td>AI1 maximum (parameter setting)</td> </tr> </table>	AI1min	The voltage value received from the measuring device when the measured process actual value is at the desired minimum level.	13.01	AI1 minimum (parameter setting)	13.02	AI1 maximum (parameter setting)	-10000 ... 10000
AI1min	The voltage value received from the measuring device when the measured process actual value is at the desired minimum level.								
13.01	AI1 minimum (parameter setting)								
13.02	AI1 maximum (parameter setting)								
40.10	ACT1 MAXIMUM	Defines the maximum value for the variable ACT1 if an analogue input is selected as a source for ACT1. See parameter 40.07. The minimum (40.09) and maximum settings of ACT1 define how the voltage/current signal received from the measuring device is converted to a percentage value used by the process PID controller.							
	-1000 ... 1000%	<p>Maximum value in percent of the set analogue input signal range. The equation below instructs how to calculate the value when analogue input AI1 is used as a variable ACT1.</p> $\text{ACT1 MAXIMUM} = \frac{\text{AI1max} - 13.01}{13.02 - 13.01} \cdot 100\%$ <table border="1" data-bbox="534 1590 1356 1769"> <tr> <td>AI1max</td> <td>The voltage value received from the measuring device when the measured process actual value is at the desired maximum level.</td> </tr> <tr> <td>13.01</td> <td>AI1 minimum (parameter setting)</td> </tr> <tr> <td>13.02</td> <td>AI1 maximum (parameter setting)</td> </tr> </table>	AI1max	The voltage value received from the measuring device when the measured process actual value is at the desired maximum level.	13.01	AI1 minimum (parameter setting)	13.02	AI1 maximum (parameter setting)	-10000 ... 10000
AI1max	The voltage value received from the measuring device when the measured process actual value is at the desired maximum level.								
13.01	AI1 minimum (parameter setting)								
13.02	AI1 maximum (parameter setting)								
40.11	ACT2 MINIMUM	See parameter 40.09.							
	-1000 ... 1000%	See parameter 40.09.	-10000 ... 10000						

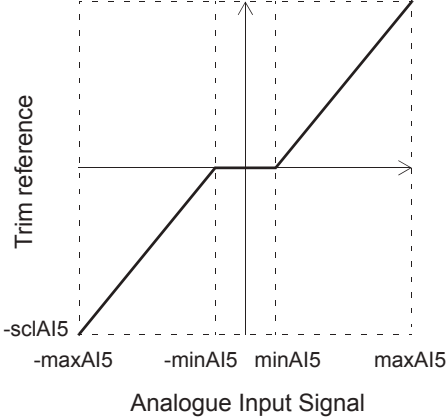
Index	Name/Selection	Description	FbEq
40.12	ACT2 MAXIMUM	See parameter 40.10.	
	-1000 ... 1000%	See parameter 40.10.	-10000 ... 10000
40.13	PID INTEGRATION	Activates the integration of the process PID controller.	
	OFF	Inactive	1
	ON	Active	2
40.14	TRIM MODE	Activates the trim function and selects between the direct and proportional trimming. Using the trim it is possible to combine a corrective factor to the drive reference. See section Reference trimming on page 47. Example: A speed-controlled conveyor line where the line tension also needs to be considered: The speed reference is slightly adjusted (trimmed) depending on the value of the measured line tension. Not visible when parameter 99.02 = PID CTRL.	
	OFF	The trim function is deactivated.	1
	PROPORTIONAL	The trim function is active. The trimming factor is relative to the external %-reference (REF2). See parameter 11.06.	2
	DIRECT	The trim function is active. The trimming factor is relative to a fixed maximum limit used in the reference control loop (maximum speed, frequency or torque).	3
40.15	TRIM REF SEL	Selects the signal source for the trim reference. Not visible when parameter 99.02 = PID CTRL. Example: AI5 as a trim reference sclAI5  minAI5 = parameter 13.16 maxAI5 = parameter 13.17 sclAI5 = parameter 13.18 AI5 be used only with an optional I/O extension module.	
	AI1	Analogue input AI1	1
	AI2	Analogue input AI2	2
	AI3	Analogue input AI3	3
	AI5	Analogue input AI5	4
	AI6	Analogue input AI5	5
	PAR 40.16	Value of parameter 40.16 is used as the trim reference.	6
	PAR 40.28	Value of parameter 40.28 is used as the trim reference.	7
40.16	TRIM REFERENCE	Defines the trim reference value when parameter 40.15 has the value PAR 40.16 selected. Not visible when parameter 99.02 = PID CTRL.	
	-100.0 ... 100.0%	Trim reference	- 10000 ... 10000

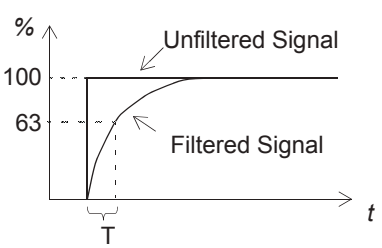
Index	Name/Selection	Description	FbEq
40.17	TRIM RANGE ADJUST	Defines the multiplier for the PID controller output used as the trimming factor. Not visible when parameter 99.02 = PID CTRL.	
	-100.0 ... 100.0%	Multiplying factor	- 10000 ... 10000
40.18	TRIM SELECTION	Selects whether the trimming is used for correcting the speed or torque reference. Not visible when parameter 99.02 = PID CTRL.	
	SPEED TRIM	Speed reference trimming	1
	TORQUE TRIM	Torque reference trimming	2
	DIRECT SPD T	Speed reference trimming. Trim reference is added to the speed reference after ramp calculations. Trimming is not effective during ramp stop, emergency stop or at speed defined by parameter 30.18 in a fieldbus communication break.	3
40.19	ACTUAL FILT TIME	Defines the time constant for the filter through which the actual signals are connected to the process PID controller.	
	0.04 ... 10.00 s	Filter time constant.  $O = I \cdot (1 - e^{-t/T})$ I = filter input (step) O = filter output t = time T = filter time constant	4 ... 1000
40.20	SLEEP SELECTION	Activates the sleep function and selects the source for the activation input. Visible only when parameter 99.02 = PID CTRL. See section Sleep function for the process PID control on page 71.	
	OFF	Inactive	1
	INTERNAL	Activated and deactivated automatically as defined by parameters 40.21 and 40.23.	2
	DI1	The function is activated/deactivated through digital input DI1. Activation: Digital input DI1 = 1. Deactivation: DI1 = 0. The internal sleep criteria set by parameters 40.21 and 40.23 are not effective. The sleep start and stop delays are effective (parameter 40.22 and 40.24).	3
	DI2	See selection DI1.	4
	DI3	See selection DI1.	5
	DI4	See selection DI1.	6
	DI5	See selection DI1.	7
	DI6	See selection DI1.	8
	DI7	See selection DI1.	9
	DI8	See selection DI1.	10
	DI9	See selection DI1.	11
	DI10	See selection DI1.	12
	DI11	See selection DI1.	13
	DI12	See selection DI1.	14

Index	Name/Selection	Description	FbEq
40.21	SLEEP LEVEL	Defines the start limit for the sleep function. If the motor speed is below a set level (40.21) longer than the sleep delay (40.22), the drive shifts to the sleeping mode: the motor is stopped and the control panel shows the warning message "SLEEP MODE". Visible only when parameter 99.02 = PID CTRL.	
	0.0 ... 7200.0 rpm	Sleep start level	0 ... 7200
40.22	SLEEP DELAY	Defines the delay for the sleep start function. See parameter 40.21. When the motor speed falls below the sleep level, the counter starts. When the motor speed exceeds the sleep level, the counter resets. Visible only when parameter 99.02 = PID CTRL.	
	0.0 ... 3600.0 s	Sleep start delay	0 ... 36000
40.23	WAKE UP LEVEL	Defines the wake-up limit for the sleep function. The drive wakes up if the process actual value is below a set level (40.23) longer than the wake-up delay (40.24). Visible only when parameter 99.02 = PID CTRL.	
	0.0 ... 100.0%	The wake-up level in percent of the actual process value.	0 ... 10000
40.24	WAKE UP DELAY	Defines the wake-up delay for the sleep function. See parameter 40.23. When the process actual value falls below the wake-up level, the wake-up counter starts. When the process actual value exceeds the wake-up level, the counter resets. Visible only when parameter 99.02 = PID CTRL.	
	0.0 ... 3600.0 s	Wake-up delay	0 ... 36000
40.25	ACTUAL1 PTR	Defines the source or constant for value PAR 40.25 of parameter 40.07.	
	-255.255.31 ... +255.255.31 / C.- 32768 ... C.32767	Parameter index or a constant value. See parameter 10.04 for information on the difference.	100 = 1%
40.26	PID MINIMUM	Defines the minimum limit for the PID controller output. Using the minimum and maximum limits, it is possible to restrict the operation to a certain speed range. Example: The process PID control is restricted to the forward rotation direction of the motor by setting the PID minimum limit to 0% and the maximum to 100%.	
	-100 ... 100%	Limit in percent of the Absolute Maximum Speed of the motor	100 = 1%
40.27	PID MAXIMUM	Defines the maximum limit for the PID controller output. Using the minimum and maximum limits, it is possible to restrict the operation to a certain speed range. See parameter 40.26.	
	-100 ... 100%	Limit in percent of the Absolute Maximum Speed of the motor	100 = 1%
40.28	TRIM REF PTR	Defines the trim reference value when parameter 40.15 has been set to value PAR 40.28.	
	-255.255.31 ... +255.255.31 / C.- 32768 ... C.32767	Parameter index or a constant value: - Parameter pointer: Inversion, group, index and bit fields. The bit number is effective only for blocks handling boolean inputs. - Constant value: Inversion and constant fields. Inversion field must have value C to enable the constant setting.	100 = 1%
42 BRAKE CONTROL		Control of a mechanical brake. The function operates on a 100 ms time level. For the function description, see section <i>Control of a mechanical brake</i> on page 77.	
42.01	BRAKE CTRL	Activates the brake control function.	
	OFF	Inactive	1

Index	Name/Selection	Description	FbEq
	ON	Active	2
42.02	BRAKE ACKNOWLEDGE	Activates the external brake on/off supervision and selects the source for the signal. The use of the external on/off supervision signal is optional.	
	OFF	Inactive	1
	DI5	Active. Digital input DI5 is the signal source. DI5 = 1: The brake is open. DI5 = 0: the brake is closed.	2
	DI6	See selection DI5.	3
	DI11	See selection DI5.	4
	DI12	See selection DI5.	5
42.03	BRAKE OPEN DELAY	Defines the brake open delay (= the delay between the internal open brake command and the release of the motor speed control). The delay counter starts when the drive has magnetised the motor and risen the motor torque to the level required at the brake release (parameters 42.07 and 42.08). Simultaneously with the counter start, the brake function energises the relay output controlling the brake and the brake starts opening.	
	0.0 ... 5.0 s	Delay time. Set the delay the same as the mechanical opening delay of the brake specified the brake manufacturer.	0 ... 500
42.04	BRAKE CLOSE DELAY	Defines the brake close delay. The delay counter starts when the motor actual speed has fallen below the set level (parameter 42.05) after the drive has received the stop command. Simultaneously with the counter start, the brake control function de-energises the relay output controlling the brake and the brake starts closing. During the delay, the brake function keeps the motor live preventing the motor speed from falling below zero.	
	0.0 ... 60.0 s	Delay time. Set the delay time to the same value as the mechanical make-up time of the brake (= operating delay when closing) specified by the brake manufacturer.	0 ... 6000
42.05	ABS BRAKE CLS SPD	Defines the brake close speed. See parameter 42.04.	
	0 ... 1000 rpm	Speed (an absolute value)	0 ... 100000
42.06	BRAKE FAULT FUNC	Defines how the drive reacts in case the status of the optional external brake acknowledgement signal does not meet the status presumed by the brake control function.	
	FAULT	The drive trips on a fault: fault indication and drive stops the motor.	1
	WARNING	The drive generates a warning.	2
42.07	START TORQ REF SEL	Selects the source for the motor starting torque reference applied at the brake release. The value is read in percent of the motor nominal torque.	
	NO	No source selected. This is the default value.	1
	AI1	Analogue input AI1	2
	AI2	Analogue input AI2	3
	AI3	Analogue input AI3	4
	AI5	Analogue input AI5	5
	AI6	Analogue input AI6	6
	PAR 42.08	Defined by parameter 42.08.	7
	MEMORY	The motor torque stored at the previous brake close command.	8
42.08	START TORQ REF	Defines the motor starting torque at brake release if parameter 42.07 has value PAR 40.28.	

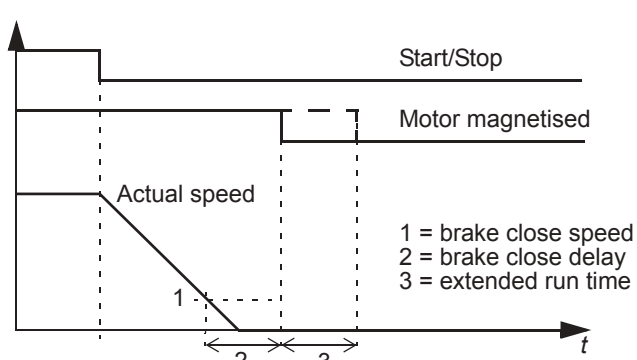
Index	Name/Selection	Description	FbEq
	-300 ... 300%	Torque value in percent of the motor nominal torque	-30000 ... 30000
42.09	EXTEND RUN T	Defines an extended run time for the brake control function at stop. During the delay, the motor is kept magnetised and ready for an immediate restart.	
	0.0 ... 60.0 s	<p>0.0 s = Normal stop routine of the brake control function: The motor magnetisation is switched off after the brake close delay has passed.</p> <p>0.1 ... 60.0 s = Extended stop routine of the brake control function: The motor magnetisation is switched off after the brake close delay and the extended run time have passed. During the extended run time, a zero torque reference is applied, and the motor is ready for a immediate restart.</p>  <p>1 = brake close speed 2 = brake close delay 3 = extended run time</p>	100 = 1 s
42.10	LOW REF BRK HOLD	Activates a brake hold function and defines the hold delay for it. The function stabilises the operation of the brake control application when the motor operates near zero speed and there is no measured speed feedback available (pulse encoder).	
	0.0 ... 60.0 s	<p>0.0 s = inactive.</p> <p>0.1 s ... 60.0 s = active. When the absolute value of the motor speed reference falls below the brake close speed:</p> <ul style="list-style-type: none"> - The brake hold delay counter starts. - The brake is closed according to normal stop routine of the brake control function. <p>During the delay, the function keeps the brake closed despite of the speed reference value and the value of start command. When the set delay has passed, the normal operation resumes.</p>	100 = 1 s
45 ENERGY OPT		Energy optimization settings	
45.02	ENERGY TARIFF1	Price of energy per kWh. Used for reference when savings are calculated. See parameters 01.46 SAVED KWH , 01.48 SAVED AMOUNT and 01.50 SAVED CO2 .	
	0.0000...1024.0000	Price of energy per kWh.	1 = 0.001
45.06	E TARIFF UNIT	Specifies the currency used for the savings calculation.	
	LOCAL	The currency is determined by the setting of parameter 99.01 Language.	0
	EUR	Euro	1
	USD	US dollar	2
45.08	PUMP REF POWER	Pump power when connected directly to supply. Used for reference when energy savings are calculated. See parameters 01.46 SAVED KWH , 01.48 SAVED AMOUNT and 01.50 SAVED CO2 .	

Index	Name/Selection	Description	FbEq
	0... 950%	Pump power in percent of nominal motor power. Note: The maximum value depends on the motor and is calculated in power-up or when the motor power changes.	1000 = 100%
45.09	ENERGY RESET	Resets the energy counters 01.46 SAVED KWH , 01.47 SAVED GWH , 01.48 SAVED AMOUNT , 01.49 SAVED AMOUNT M , 01.50 SAVED CO2 and 01.51 SAVED CO2 KTON .	
	DONE	Reset not requested (normal operation).	0
	RESET	Reset energy counters. The value reverts automatically to DONE.	1
50 ENCODER MODULE		Encoder connection. Visible only when a pulse encoder module (optional) is installed and activated by parameter 98.01 . The settings will remain the same even though the application macro is changed.	
50.01	PULSE NR	States the number of encoder pulses per one revolution.	
	0 ... 29999 ppr	Pulse number in pulses per round (ppr)	0 ... 29999
50.02	SPEED MEAS MODE	Defines how the encoder pulses are calculated.	
	A _ B DIR	Channel A: positive edges calculated for speed. Channel B: direction.	0
	A _ _	Channel A: positive and negative edges calculated for speed. Channel B: not used.	1
	A _ _ B DIR	Channel A: positive and negative edges are calculated for speed. Channel B: direction.	2
	A _ _ B _ _	All edges of the signals are calculated.	3
50.03	ENCODER FAULT	Defines the operation of the drive if a failure is detected in communication between the pulse encoder and the pulse encoder interface module, or between the module and the drive. Encoder supervision function activates if either of the following conditions is valid: -The difference between estimated and measured speed is greater than 20% of the motor nominal speed. - No pulses are received from the encoder within the defined time (see parameter 50.04) and the drive is simultaneously at current or torque limit.	
	WARNING	The drive generates a warning indication.	0
	FAULT	The drive trips on a fault, gives a fault indication and stops the motor.	65535
50.04	ENCODER DELAY	Defines the time delay for the encoder supervision function (See parameter 50.03).	
	0 ... 50000 ms	Time delay	0 ... 50000
50.05	ENCODER DDCS CH	Defines the fibre optic channel of the control board from which the drive program reads the signals coming from the pulse encoder interface module. The setting is valid only if the module is connected to the drive via the DDCS link (i.e. not to the option slot of the drive).	
	CH 1	Signals via channel 1 (CH1). The pulse encoder interface module must be connected to CH1 instead of CH2 in applications where CH2 is reserved by a Master station (e.g. a Master/Follower application). See also parameter 70.03 .	1
	CH 2	Signals via channel 2 (CH2). Can be used in most cases.	2
50.06	SPEED FB SEL	Defines the speed feedback value used in control.	
	INTERNAL	Calculated speed estimate	65535
	ENCODER	Actual speed measured with an encoder	0

Index	Name/Selection	Description	FbEq
50.07	ENC CABLE CHECK	Selects the drive operation when encoder signal is missing. Note: Monitoring is only for RTAC-03. For more information, see <i>RTAC-03 Pulse Encoder Interface Module User's Manual</i> [3AFE68650500 (English)].	
	NO	No action	0
	WARNING	Drive generates warning ENC CABLE.	1
	FAULT	Drive trips on fault ENC CABLE.	2
51 COMM MODULE DATA		The parameters are visible and need to be adjusted, only when a fieldbus adapter module (optional) is installed and activated by parameter 98.02 . For details on the parameters, refer to the manual of the fieldbus module and chapter <i>Fieldbus control</i> . These parameter settings will remain the same even though the macro is changed.	
52 STANDARD MODBUS		The settings for the Standard Modbus Link. See chapter <i>Fieldbus control</i> .	
52.01	STATION NUMBER	Defines the address of the device. Two units with the same address are not allowed on-line.	
	1 ... 247	Address	1 = 1
52.02	BAUDRATE	Defines the transfer rate of the link.	
	600	600 bit/s	1
	1200	1200 bit/s	2
	2400	2400 bit/s	3
	4800	4800 bit/s	4
	9600	9600 bit/s	5
	19200	19200 bit/s	6
52.03	PARITY	Defines the use of parity and stop bit(s). The same setting must be used in all on-line stations.	
	NONE1STOPBIT	No parity bit, one stop bit	1
	NONE2STOPBIT	No parity bit, two stop bits	2
	ODD	Odd parity indication bit, one stop bit	3
	EVEN	Even parity indication bit, one stop bit	4
60 MASTER/FOLLOWER		Master/Follower application. For more information, see section <i>Master/Follower use of several drives</i> on page 80 and a separate <i>Master/Follower Application Guide</i> [3AFE64590430 (English)].	
60.01	MASTER LINK MODE	Defines the role of the drive on the Master/Follower link. Note: Two Master stations are not allowed on-line. If a Follower drive is changed to be a Master drive (or vice versa) by this parameter, the RMIO board must be powered up again for the M/F link to work properly.	
	NOT IN USE	The Master/Follower link is not active.	1
	MASTER	Master drive	2
	FOLLOWER	Follower drive	3
	STANDBY	Follower drive which reads the control signals through a fieldbus interface, not from the Master/Follower link as usual.	4
60.02	TORQUE SELECTOR	Selects the reference used in motor torque control. Typically, the value needs to be changed only in the Follower station(s). The parameter is visible only when parameter 99.02 = T CTRL. External control location 2 (EXT2) must be active to enable torque selector.	

Index	Name/Selection	Description	FbEq
	ZERO	This selection forces the output of the torque selector to zero.	1
	SPEED	The follower speed controller output is used as a reference for motor torque control. The drive is speed-controlled. SPEED can be used both in the Follower and in the Master if - the motor shafts of the Master and Follower are connected flexibly. (A slight speed difference between the Master and the Follower is possible/allowed.) - drooping is used (see parameter 60.06).	2
	TORQUE	The drive is torque-controlled. The selection is used in the Follower(s) when the motor shafts of the Master and Follower are coupled solidly to each other by gearing, a chain or other means of mechanical power transmission and no speed difference between the drives is allowed or possible. Note: If TORQUE is selected, the drive does not restrict the speed variation as long as the speed is within the limits defined by parameters 20.01 and 20.02. More definite speed supervision is often needed. In those cases, the selection ADD should be used instead of TORQUE.	3
	MINIMUM	The torque selector compares the direct torque reference and the speed controller output, and the smaller of them is used as the reference for the motor torque control. MINIMUM is selected in special cases only.	4
	MAXIMUM	The torque selector compares the direct torque reference and the speed controller output and the greater of them is used as the reference for the motor torque control. MAXIMUM is selected in special cases only.	5
	ADD	The torque selector adds the speed controller output to the direct torque reference. The drive is torque-controlled in the normal operating range. The selection ADD, together with the window control, forms a speed supervision function for a torque-controlled Follower drive. See parameter 60.03.	6
60.03	WINDOW SEL ON	Activates the Window control function. The Window control, together with selection ADD at parameter 60.02, forms a speed supervision function for a torque-controlled drive. The parameter is visible only when parameter 99.02 is T CTRL. External control location 2 (EXT2) must be active to enable window control.	
	NO	Inactive	0
	YES	Window control is active. Selection YES is used only when parameter 60.02 has value ADD. Window control supervises the speed error value (Speed Reference - Actual Speed). In the normal operating range, window control keeps the speed controller input at zero. The speed controller is evoked only if: - the speed error exceeds the value of parameter 60.04 or - the absolute value of the negative speed error exceeds the value of parameter 60.05. When the speed error moves outside the window, the exceeding part of the error value is connected to the speed controller. The speed controller produces a reference term relative to the input and gain of the speed controller (parameter 23.01) which the torque selector adds to the torque reference. The result is used as the internal torque reference for the drive. Example: In a load loss condition, the internal torque reference of the drive is decreased to prevent an excessive rise of the motor speed. If window control were inactivated, the motor speed would rise until a speed limit of the drive were reached.	65535
60.04	WINDOW WIDTH POS	Defines the supervision window width above the speed reference. See parameter 60.03. The parameter is visible only when parameter 99.02 is T CTRL.	
	0 ... 1500 rpm	Positive window width	0... 20000

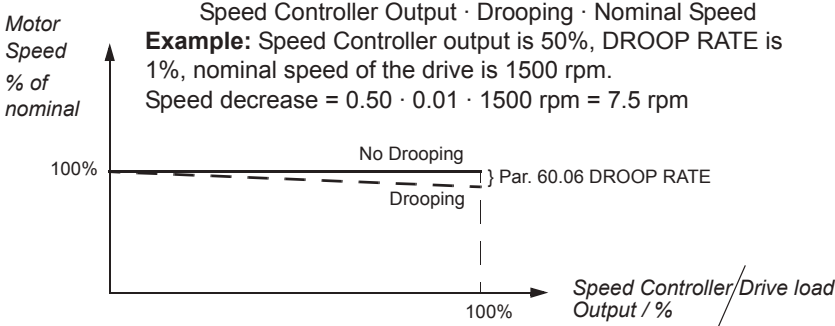
Index	Name/Selection	Description	FbEq
60.05	WINDOW WIDTH NEG	Defines the supervision window width below the speed reference. See parameter 60.03. The parameter is visible only when parameter 99.02 is T CTRL.	
	0 ... 1500 rpm	Negative window width	0 ... 20000
60.06	DROOP RATE	<p>Defines the droop rate. The parameter value needs to be changed only if both the Master and the Follower are speed-controlled:</p> <ul style="list-style-type: none"> - External control location 1 (EXT1) is selected (see parameter 11.02 or - External control location 2 (EXT2) is selected (see parameter 11.02) and parameter 60.02 is set to SPEED. <p>The droop rate needs to be set both for the Master and the Follower. The correct droop rate for a process must be found out case by case in practice.</p> <p>The drooping prevents a conflict between the Master and the Follower by allowing a slight speed difference between them. The drooping slightly decreases the drive speed as the drive load increases. The actual speed decrease at a certain operating point depends on the droop rate setting and the drive load (= torque reference / speed controller output). At 100% speed controller output, drooping is at its nominal level, i.e. equal to the value of the DROOP RATE. The drooping effect decreases linearly to zero along with the decreasing load.</p> <p style="text-align: center;">Speed Decrease = Speed Controller Output · Drooping · Nominal Speed</p> <p>Example: Speed Controller output is 50%, DROOP RATE is 1%, nominal speed of the drive is 1500 rpm. Speed decrease = 0.50 · 0.01 · 1500 rpm = 7.5 rpm</p> 	
	0 ... 100%	Droop rate in percent of the motor nominal speed	0 ... 1000
60.07	MASTER SIGNAL 2	Selects the signal that is sent by the Master to the Follower(s) as Reference 1 (speed reference).	
	0000 ... 9999	Parameter index	0000 ... 9999
60.08	MASTER SIGNAL 3	Selects the signal that is sent by the Master to the Follower(s) as Reference 2 (torque reference).	
	0000 ... 9999	Parameter index	0000 ... 9999
70 DDCS CONTROL		Settings for the fibre optic channels 0, 1 and 3.	
70.01	CHANNEL 0 ADDR	Defines the node address for channel 0. No two nodes on-line may have the same address. The setting needs to be changed when a master station is connected to channel 0 and it does not automatically change the address of the slave. Examples of such masters are an ABB Advant Controller or another drive.	
	1 ... 125	Address.	1 ... 125
70.02	CHANNEL 3 ADDR	Node address for channel 3. No two nodes on-line may have the same address. Typically the setting needs to be changed when the drive is connected in a ring which consists of several drives and a PC with the DriveWindow program running.	

Index	Name/Selection	Description	FbEq
	1 ... 254	Address.	1 ... 254
70.03	CH1 BAUD RATE	The communication speed of channel 1. Typically the setting needs to be changed only if the pulse encoder interface module is connected to channel 1 instead of channel 2. Then the speed must be changed to 4 Mbit/s. See also parameter 50.05 .	
	8 Mbit/s	8 megabits per second	0
	4 Mbit/s	4 megabits per second	1
	2 Mbit/s	2 megabits per second	2
	1 Mbit/s	1 megabits per second	3
70.04	CH0 DDCS HW CONN	Selects the topology of the channel 0 link.	
	RING	Devices are connected in ring topology.	0
	STAR	Devices are connected in a star topology.	65535
70.05	CH2 HW CONNECTION	Selects the topology of the DDCS channel CH2 link.	1 = 1
	0 = RING	Devices are connected in a ring. Forwarding of messages is enabled.	
	1 = STAR	Devices are connected in a star. Forwarding of messages is disabled. This selection is used with NDBU branching units.	
72 USER LOAD CURVE		See section User load curve on page 83 .	
72.01	OVERLOAD FUNC	Activates the user load curve and selects how the drive reacts when the user load curve has been exceeded.	
	NO	User load curve is inactive.	0
	WARNING	The drive generates a warning USER L CURVE . Drive output current is not limited.	1
	FAULT	The drive trips on a fault USER L CURVE .	2
	LIMIT	Drive output current is limited to $I_{user\ curve}$.	3
	LIMIT / WARN	Drive output current is limited to $I_{user\ curve}$ and the drive generates a warning USER L CURVE .	4
72.02	LOAD CURRENT 1	Defines the first current point of the load curve at the frequency defined by par. 72.10 LOAD FREQ 1 .	
	0...800%	Value in percent of the nominal motor current	1 = 1
72.03	LOAD CURRENT 2	Defines the second current point of the load curve at the frequency defined by par. 72.11 LOAD FREQ 2 .	
	0...800%	Value in percent of the nominal motor current	1 = 1
72.04	LOAD CURRENT 3	Defines the third current point of the load curve at the frequency defined by par. 72.12 LOAD FREQ 3 .	
	0...800%	Value in percent of the nominal motor current	1 = 1
72.05	LOAD CURRENT 4	Defines the fourth current point of the load curve at the frequency defined by par. 72.13 LOAD FREQ 4 .	
	0...800%	Value in percent of the nominal motor current	1 = 1
72.06	LOAD CURRENT 5	Defines the fifth current point of the load curve at the frequency defined by par. 72.14 LOAD FREQ 5 .	
	0...800%	Value in percent of the nominal motor current	1 = 1
72.07	LOAD CURRENT 6	Defines the sixth current point of the load curve at the frequency defined by par. 72.15 LOAD FREQ 6 .	
	0...800%	Value in percent of the nominal motor current	1 = 1

Index	Name/Selection	Description	FbEq
72.08	LOAD CURRENT 7	Defines the seventh current point of the load curve at the frequency defined by par. 72.16 LOAD FREQ 7.	
	0...800%	Value in percent of the nominal motor current	1 = 1
72.09	LOAD CURRENT 8	Defines the eighth current point of the load curve at the frequency defined by par. 72.17 LOAD FREQ 8.	
	0...800%	Value in percent of the nominal motor current	1 = 1
72.10	LOAD FREQ 1	Defines the first frequency point of the load curve.	
	0... par. 72.11 %	Value in percent of the nominal motor frequency	1 = 1
72.11	LOAD FREQ 2	Defines the second frequency point of the load curve.	
	par. 72.10... par. 72.12 %	Value in percent of the nominal motor frequency	1 = 1
72.12	LOAD FREQ 3	Defines the third frequency point of the load curve.	
	par. 72.11... par. 72.13 %	Value in percent of the nominal motor frequency	1 = 1
72.13	LOAD FREQ 4	Defines the fourth frequency point of the load curve.	
	par. 72.12... par. 72.14 %	Value in percent of the nominal motor frequency	1 = 1
72.14	LOAD FREQ 5	Defines the fifth frequency point of the load curve.	
	par. 72.13... par. 72.15 %	Value in percent of the nominal motor frequency	1 = 1
72.15	LOAD FREQ 6	Defines the sixth frequency point of the load curve.	
	par. 72.14... par. 72.16 %	Value in percent of the nominal motor frequency	1 = 1
72.16	LOAD FREQ 7	Defines the seventh frequency point of the load curve.	
	par. 72.15... par. 72.17 %	Value in percent of the nominal motor frequency	1 = 1
72.17	LOAD FREQ 8	Defines the eight frequency point of the load curve.	
	par. 72.16...600%	Value in percent of the nominal motor frequency	1 = 1
72.18	LOAD CURRENT LIMIT	<p>Defines the overload current. Value is used by the overload integrator ($\int i^2 dt$). If the continuous motor load capacity (i.e. the defined user load curve) is not 100% at the nominal frequency, calculate the overload current using the following equation:</p> $72.18 \text{ LOAD CURRENT LIMIT} = \sqrt{I_{\text{overload}}^2 - I_{\text{user curve}}^2 + 100^2}$ <p>where I_{overload} is the motor overload and $I_{\text{user curve}}$ is the current defined by the user load curve at the nominal frequency. User load curve is defined by parameters 72.02...72.17.</p> <p>Example: Motor overload capacity is 150% of the nominal current for 10 s / 10 min and the continuous load capacity is 80% at the nominal frequency:</p> $72.18 \text{ LOAD CURRENT LIMIT} = \sqrt{150^2 - 80^2 + 100^2} = 162\%$ $72.19 \text{ LOAD THERMAL TIME} = 10 \text{ s}$ $72.20 \text{ LOAD COOLING TIME} = 590 \text{ s}$	
	100...800%	Value in percent of the nominal motor current (99.06 MOTOR NOM CURRENT)	10 = 1%

Index	Name/Selection	Description	FbEq
72.19	LOAD THERMAL TIME	Defines the overload time. Value is used by the overload integrator ($\int I^2 dt$). See the example given for par. 72.18 LOAD CURRENT LIMIT.	10 = 1 s
	0.0...9999.9 s	Time. If the value is set to zero, the drive output current is limited to the user load curve defined by parameters 72.02...72.17.	
72.20	LOAD COOLING TIME	Defines the cooling time. The output of the overload integrator is set to zero if the current stays continuously below the user load curve for the defined cooling time. See the example given for par. 72.18 LOAD CURRENT LIMIT.	
	0...9999 s	Time	1 = 1 s
83 ADAPT PROG CTRL		Control of the Adaptive Program execution. For more information, see the <i>Adaptive Program Application Guide</i> [3AFE64527274 (English)].	
83.01	ADAPT PROG CMD	Selects the operation mode for the Adaptive Program.	
	STOP	Stop. The program cannot be edited.	1
	RUN	Run. The program cannot be edited.	2
	EDIT	Stop to edit mode. Program can be edited.	3
83.02	EDIT COMMAND	Selects the command for the block placed in the location defined by parameter 83.03. The program must be in editing mode (see parameter 83.01).	
	NO	Home value. The value automatically restores to NO after an editing command has been executed.	1
	PUSH	Shifts the block in location defined by parameter 83.03 and the following blocks one location up. A new block can be placed in the emptied location by programming the Block Parameter Set as usual. Example: A new block needs to be placed in between the current block number four (parameters 84.20 ... 84.25) and five (parameters 84.25 ... 84.29). In order to do this: - Shift the program to the editing mode by parameter 83.01. - Select location number five as the desired location for the new block by parameter 83.03. - Shift the block in location number 5 and the following blocks one location forward by parameter 83.02. (selection PUSH) - Program the emptied location number 5 by parameters 84.25 to 84.29 as usual.	2
	DELETE	Deletes the block in location defined by parameter 83.03 and shifts the following blocks one step down.	3
	PROTECT	Activation of the Adaptive Program protection. Activate as follows: - Ensure the Adaptive Program operation mode is START or STOP (parameter 83.01). - Set the passcode (parameter 83.05). - Change parameter 83.02 to PROTECT. When activated: - All parameters in group 84 excluding the block output parameters are hidden (read protected). - It is not possible to switch the program to the editing mode (parameter 83.01). - Parameter 83.05 is set to 0.	4

Index	Name/Selection	Description	FbEq																											
	UNPROTECT	Inactivation of the Adaptive Program protection. Inactivate as follows: - Ensure the Adaptive Program operation mode is START or STOP (parameter 83.01). - Set the passcode (parameter 83.05). - Change parameter 83.02 to UNPROTECT. Note: If the passcode is lost, it is possible to reset the protection also by changing the application macro setting (parameter 99.02).	5																											
83.03	EDIT BLOCK	Defines the block location number for the command selected by parameter 83.02 .																												
	1 ... 15	Block location number	1 = 1																											
83.04	TIMELEVEL SEL	Selects the execution cycle time for the Adaptive Program. The setting is valid for all blocks.																												
	12 ms	12 milliseconds	1																											
	100 ms	100 milliseconds	2																											
	1000 ms	1000 milliseconds	3																											
83.05	PASSCODE	Sets the passcode for the Adaptive Program protection. The passcode is needed at activation and inactivation of the protection. See parameter 83.02 .																												
	0 ...	Passcode. The setting restores to 0 after the protection is activated/inactivated. Note: When activating, write down the passcode and store it in a safe place.																												
84 ADAPTIVE PROGRAM		- selections of the function blocks and their input connections. - diagnostics For more information, see the <i>Adaptive Program Application Guide</i> [3AFE64527274 (English)].																												
84.01	STATUS	Shows the value of the Adaptive Program status word. The table below shows the alternative bit states and the corresponding values on the panel display. <table border="1" data-bbox="443 1205 975 1491"> <thead> <tr> <th>Bit</th> <th>Display</th> <th>Meaning</th> </tr> </thead> <tbody> <tr> <td>0</td> <td>1</td> <td>Stopped</td> </tr> <tr> <td>1</td> <td>2</td> <td>Running</td> </tr> <tr> <td>2</td> <td>4</td> <td>Faulted</td> </tr> <tr> <td>3</td> <td>8</td> <td>Editing</td> </tr> <tr> <td>4</td> <td>10</td> <td>Checking</td> </tr> <tr> <td>5</td> <td>20</td> <td>Pushing</td> </tr> <tr> <td>6</td> <td>40</td> <td>Popping</td> </tr> <tr> <td>8</td> <td>100</td> <td>Initialising</td> </tr> </tbody> </table>	Bit	Display	Meaning	0	1	Stopped	1	2	Running	2	4	Faulted	3	8	Editing	4	10	Checking	5	20	Pushing	6	40	Popping	8	100	Initialising	
Bit	Display	Meaning																												
0	1	Stopped																												
1	2	Running																												
2	4	Faulted																												
3	8	Editing																												
4	10	Checking																												
5	20	Pushing																												
6	40	Popping																												
8	100	Initialising																												
84.02	FAULTED PAR	Points out the faulted parameter in the Adaptive Program.	-																											
84.05	BLOCK1	Selects the function block for Block Parameter Set 1. See the <i>Adaptive Program Application Guide</i> [3AFE64527274 (English)].																												
	ABS		11																											
	ADD		10																											
	AND		2																											
	BITWISE		26																											
	COMPARE		16																											
	COUNT		21																											
	DPOT		23																											
	EVENT		20																											

Index	Name/Selection	Description	FbEq
	FILTER		13
	MASK-SET		24
	MAX		17
	MIN		18
	MULDIV		12
	NO		1
	OR		3
	PI		14
	PI-BAL		15
	PI BIPOLAR		25
	RAMP		22
	SR		5
	SWITCH-B		7
	SWITCH-I		19
	TOFF		9
	TON		8
	TRIGG		6
	XOR		4
84.06	INPUT1	Selects the source for input I1 of Block Parameter Set 1.	
	-255.255.31 ... +255.255.31 / C.- 32768 ... C.32767	<p>Parameter index or a constant value:</p> <ul style="list-style-type: none"> - Parameter pointer: Inversion, group, index and bit fields. The bit number is effective only for blocks handling boolean inputs. - Constant value: Inversion and constant fields. Inversion field must have value C to enable the constant setting. <p>Example: The state of digital input DI2 is connected to Input 1 as follows:</p> <ul style="list-style-type: none"> - Set the source selection parameter (84.06) to +.01.17.01. (The application program stores the state of digital input DI2 to bit 1 of actual signal 01.17.) - If you need an inverted value, switch the sign of the pointer value (-01.17.01.). 	-
84.07	INPUT2	See parameter 84.06 .	
	-255.255.31 ... +255.255.31 / C.- 32768 ... C.32767	See parameter 84.06 .	-
84.08	INPUT3	See parameter 84.06 .	
	-255.255.31 ... +255.255.31 / C.- 32768 ... C.32767	See parameter 84.06 .	-
84.09	OUTPUT	Stores and displays the output of Block Parameter Set 1.	
...	...		
84.79	OUTPUT	Stores the output of Block Parameter Set 15.	-
85 USER CONSTANTS		Storage of the Adaptive Program constants and messages. For more information, see the <i>Adaptive Program Application Guide</i> [3AFE64527274 (English)].	
85.01	CONSTANT1	Sets a constant for the Adaptive Program.	
	-8388608 to 8388607	Integer value	1 = 1

Index	Name/Selection	Description	FbEq
85.02	CONSTANT2	Sets a constant for the Adaptive Program.	
	-8388608 to 8388607	Integer value	1 = 1
85.03	CONSTANT3	Sets a constant for the Adaptive Program.	
	-8388608 to 8388607	Integer value	1 = 1
85.04	CONSTANT4	Sets a constant for the Adaptive Program.	
	-8388608 to 8388607	Integer value	1 = 1
85.05	CONSTANT5	Sets a constant for the Adaptive Program.	
	-8388608 to 8388607	Integer value	1 = 1
85.06	CONSTANT6	Sets a constant for the Adaptive Program.	
	-8388608 to 8388607	Integer value	1 = 1
85.07	CONSTANT7	Sets a constant for the Adaptive Program.	
	-8388608 to 8388607	Integer value	1 = 1
85.08	CONSTANT8	Sets a constant for the Adaptive Program.	
	-8388608 to 8388607	Integer value	1 = 1
85.09	CONSTANT9	Sets a constant for the Adaptive Program.	
	-8388608 to 8388607	Integer value	1 = 1
85.10	CONSTANT10	Sets a constant for the Adaptive Program.	
	-8388608 to 8388607	Integer value	1 = 1
85.11	STRING1	Stores a message to be used in the Adaptive Program (EVENT block).	
	MESSAGE1	Message	-
85.12	STRING2	Stores a message to be used in the Adaptive Program (EVENT block).	
	MESSAGE2	Message	-
85.13	STRING3	Stores a message to be used in the Adaptive Program (EVENT block).	
	MESSAGE3	Message	-
85.14	STRING4	Stores a message to be used in the Adaptive Program (EVENT block).	
	MESSAGE4	Message	-
85.15	STRING5	Stores a message to be used in the Adaptive Program (EVENT block).	
	MESSAGE5	Message	-
90 D SET REC ADDR		- Addresses into which the received fieldbus data sets are written. - Numbers of the main and auxiliary data sets. The parameters are visible only when a fieldbus communication is activated by parameter 98.02 . For more information, see chapter Fieldbus control .	
90.01	AUX DS REF3	Selects the address into which the value of fieldbus reference REF3 is written.	
	0 ... 8999	Parameter index	
90.02	AUX DS REF4	Selects the address into which the value of fieldbus reference REF4 is written.	
	0 ... 8999	Parameter index	
90.03	AUX DS REF5	Selects the address into which the value of fieldbus reference REF5 is written.	
	0 ... 8999	Parameter index	
90.04	MAIN DS SOURCE	Defines the data set from which the drive reads the Control Word, Reference REF1 and Reference REF2.	
	1 ... 255	Data set number	
90.05	AUX DS SOURCE	Defines the data set from which the drive reads References REF3, REF4 and REF5.	

Index	Name/Selection	Description	FbEq
	1 ... 255	Data set number	
92 D SET TR ADDR		Main and Auxiliary Data Sets which the drive sends to the fieldbus master station. The parameters are visible only when a fieldbus communication is activated by parameter 98.02. For more information, see chapter <i>Fieldbus control</i> .	
92.01	MAIN DS STATUS WORD	Stores the address from which the Main Status Word is read from. Fixed value, not visible.	
	302 (fixed)	Parameter index	
92.02	MAIN DS ACT1	Selects the address from which the Actual Signal 1 is read to the Main Data Set.	
	0 ... 9999	Parameter index	
92.03	MAIN DS ACT2	Selects the address from which the Actual Signal 2 is read to the Main Data Set.	
	0 ... 9999	Parameter index	
92.04	AUX DS ACT3	Selects the address from which the Actual Signal 3 is read to the Auxiliary Data Set.	
	0 ... 9999	Parameter index	
92.05	AUX DS ACT4	Selects the address from which the Actual Signal 4 is read to the Auxiliary Data Set.	
	0 ... 9999	Parameter index	
92.06	AUX DS ACT5	Selects the address from which the Actual Signal 5 is read to the Auxiliary Data Set.	
	0 ... 9999	Parameter index	
92.07	MSW B10 PTR	Selects the address from which the 03.02 Main Status Word bit 10 is read from.	
	-255.255.31 ... +255.255.31 / C.- 32768 ... C.32767	Parameter index or a constant value: - Parameter pointer: Inversion, group, index and bit fields. The bit number is effective only for blocks handling boolean inputs. - Constant value: Inversion and constant fields. Inversion field must have value C to enable the constant setting.	
92.08	MSW B13 PTR	Selects the address from which the 03.02 Main Status Word bit 13 is read from.	
	-255.255.31 ... +255.255.31 / C.- 32768 ... C.32767	Parameter index or a constant value: - Parameter pointer: Inversion, group, index and bit fields. The bit number is effective only for blocks handling boolean inputs. - Constant value: Inversion and constant fields. Inversion field must have value C to enable the constant setting.	
92.09	MSW B14 PTR	Selects the address from which the 03.02 Main Status Word bit 14 is read from.	
	-255.255.31 ... +255.255.31 / C.- 32768 ... C.32767	Parameter index or a constant value: - Parameter pointer: Inversion, group, index and bit fields. The bit number is effective only for blocks handling boolean inputs. - Constant value: Inversion and constant fields. Inversion field must have value C to enable the constant setting.	
95 HARDWARE SPECIF		Fan speed control, sine filter application etc.	
95.01	FAN SPD CTRL MODE	Selects the speed control of the optional inverter cooling fan.	
	CONST 50 Hz	Fan is running at constant frequency of 50 Hz when powered.	0

Index	Name/Selection	Description	FbEq
	RUN/STOP	Drive stopped: Fan is running at constant frequency of 10 Hz. Drive running: Fan is running at constant frequency of 50 Hz.	1
	CONTROLLED	The speed of the fan is determined from IGBT temperature vs. fan speed curve.	2
95.02	FUSE SWITCH CTRL	Activates the inverter DC switch (switch fuse) monitoring function. The monitoring must be active when the Switch Fuse Control Board (ASFC) is in use and connected to the inverter AINT board, i.e. in all frame R8i inverters equipped with the DC switch. The function must be inactive in units that do not use the ASFC board with the DC switch, i.e. for frame R2i...R7i inverters and all single drive units where no DC switch exists. The default setting (ON or OFF) for each unit is set accordingly at the factory as default. ACS800 IGBT pulses are always blocked when the program detects that the DC switch is opened or inverter charging is ongoing (at power switch on). The application program generates alarm INV DISABLED if the DC switch is opened when the inverter is stopped. The inverter trips to fault INV DISABLED if the DC switch is opened when the inverter is running.	
	OFF	Inactive	0
	ON	Active	1
95.03	INT CONFIG USER	Number of parallel connected inverter modules. Activates the Reduced Run function. See section Reduced Run function on page 82.	
	1...12	Number of parallel connected inverter modules	
95.04	EX/SIN REQUEST	Activates the sine filter or Ex-motor application.	
	NO	Inactive	1
	EX	Ex-motor application. Used with motors which comply with the ATEX directive.	2
	SIN	Sine filter application. See the <i>Sine Filters User's Manual for ACS800 Drives</i> [3AFE68389178 (English)].	3
	EX&SIN	EX-motor and sine filter applications. See the <i>Sine Filters User's Manual for ACS800 Drives</i> [3AFE68389178 (English)]. Note: This selection is not supported from firmware version AS7R7363 onwards.	4
95.05	ENA INC SW FREQ	Activates the minimum switching frequency limitation for Ex-motor applications. Parameter is visible if parameter 95.04 EX/SIN REQUEST is set to EX.	
	NO	Inactive	0
	YES	Active. Minimum switching frequency limit is set to 2 kHz. Used with motors with an ATEX certification based on 2 kHz minimum switching frequency.	1

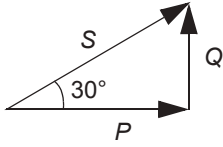
Index	Name/Selection	Description	FbEq
95.06	LCU Q PW REF	<p>Defines the reference value for the line-side converter (i.e. IGBT supply unit) reactive power generation. Line-side converter can generate reactive power to the supply network. This reference is written into line-side converter unit parameter 24.02 Q POWER REF2. For more information, see <i>IGBT Supply Control Program 7.x Firmware manual</i> [3AFE68315735 (English)].</p> <p>Example 1: When parameter 24.03 Q POWER REF2 SEL is set to PERCENT, value 10000 of parameter 24.02 Q POWER REF2 equals to value 100% of parameter 24.01 Q POWER REF (i.e. 100% of the converter nominal power given in signal 04.06 CONV NOM POWER).</p> <p>Example 2: When parameter 24.03 Q POWER REF2 SEL is set to kVAr, value 1000 of parameter 24.02 Q POWER REF2 equals to parameter 24.01 Q POWER REF value calculated with the following equation: $100 \cdot (1000 \text{ kVAr} \text{ divided by converter nominal power in kVAr})\%$.</p> <p>Example 3: When parameter 24.03 Q POWER REF2 SEL is set to PHI, value 3000 of parameter 24.02 POWER REF2 equals approximately to parameter 24.01 Q POWER REF value calculated with the following equation:</p> $\cos(30) = \frac{P}{S} = \frac{P}{\sqrt{P^2 + Q^2}}$  <p>Positive reference 30° denotes capacitive load. Negative reference 30° denotes inductive load. P = signal 01.09 POWER value</p> <p>Parameter 24.03 values are converter to degrees by the line-side converter application program: -3000...30000 $\hat{=}$ -30°...30°. Value -10000/10000 equals to -30°/30°, since the range is limited to -3000/3000.</p>	
	-10000...10000	Reference value.	See par. description.
95.07	LCU DC REF	Defines the intermediate circuit DC voltage reference for the line-side converter (i.e. IGBT supply unit). This reference is written into line-side converter parameter 23.01 DC VOLT REF. For more information, see <i>IGBT Supply Control Program 7.x Firmware manual</i> [3AFE68315735 (English)].	
	0...1100 V	Voltage	1 = 1 V
95.08	LCU PAR1 SEL	Selects the line-side converter address from which the actual signal 09.12 LCU ACT SIGNAL1 is read from.	
	0...9999	Line-side converter parameter index. Default value 106 = line-side converter parameter 01.06 LINE CURRENT. For more information, see <i>IGBT Supply Control Program 7.x Firmware manual</i> [3AFE68315735 (English)].	0...9999
95.09	LCU PAR2 SEL	Selects the line-side converter address from which the actual signal 09.13 LCU ACT SIGNAL2 is read from.	
	0...9999	Line-side converter parameter index. Default value 110 = line side converter parameter 01.10 DC VOLTAGE. For more information, see <i>IGBT Supply Control Program 7.x Firmware manual</i> [3AFE68315735 (English)].	0...9999
95.10	TEMP INV AMBIENT	Defines the ambient temperature for the Enhanced drive temperature monitoring function. See <i>Enhanced drive temperature monitoring for ACS800, frame sizes R7 and R8</i> on page 67. Note: If ambient temperature exceeds 40°C, the drive load capacity decreases. See the derating instructions in the appropriate hardware manual.	
	20...50°C	Temperature	10 = 1°C

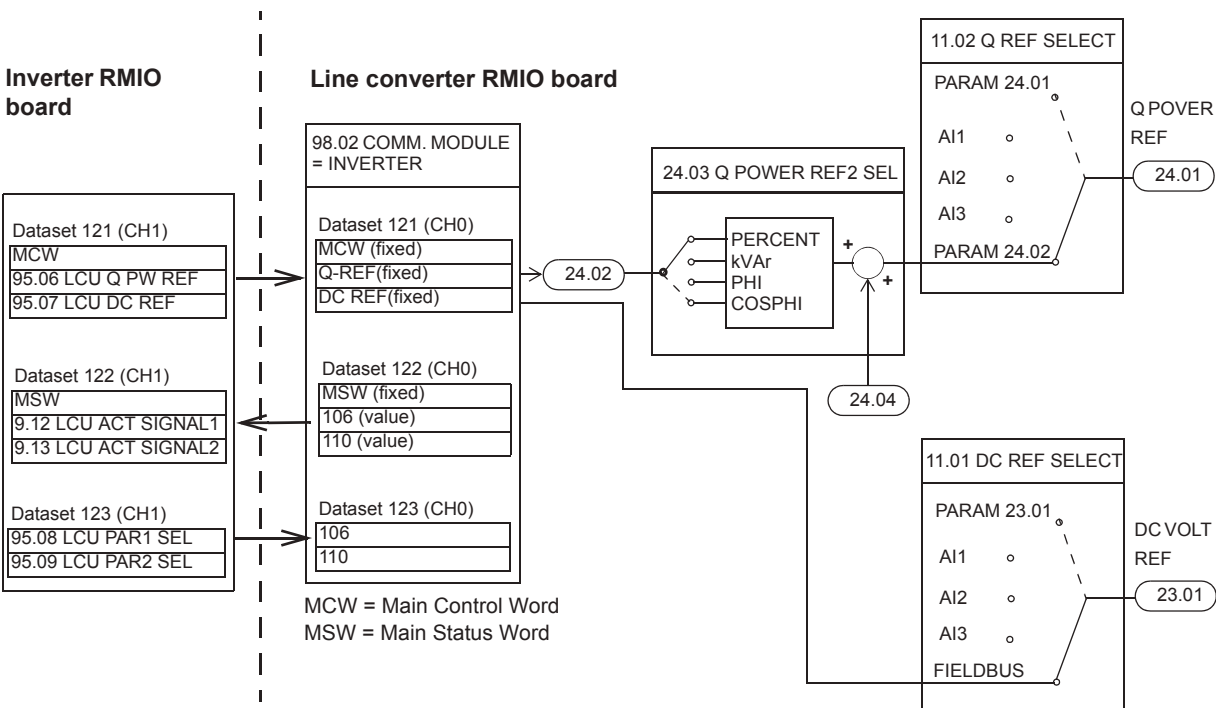
Index	Name/Selection	Description	FbEq
95.11	SUPPLY CTRL MODE	Enables/disables the control and data transfer of line-side converter unit (LSU) by inverter unit (INU). The parameter 98.02 COMM.MODULE in LSU must have the value INU COM LIM.	
	NONE	Line-side converter control disabled.	0
	LINE CONV	Limited control from the inverter RMIO board DDCS channel CH1.	65535
			
95.12	LCU RUN PTR	Selection of run command for line-side converter. When 95.11 SUPPLY CTRL MODE is set to LINE CONV, starting of modulation can be assigned freely to a parameter or signal using bit pointer. Note: This parameter is available in AS7R firmware version only.	
	-255.255.31... +255.255.31 / C.- 32768...C.32767	Parameter index or a constant value: - Parameter pointer: Inversion, group, index and bit fields. The bit number is effective only for blocks handling boolean inputs. - Constant value: Inversion and constant fields. Inversion field must have value C to enable the constant setting.	-
96 EXTERNAL AO			
		Output signal selection and processing for the analogue extension module (optional). The parameters are visible only when the module is installed and activated by parameter 98.06.	
96.01	EXT AO1	Selects the signal connected to analogue output AO1 of the analogue I/O extension module.	
	NOT USED	See parameter 15.01.	1
	P SPEED	See parameter 15.01.	2
	SPEED	See parameter 15.01.	3
	FREQUENCY	See parameter 15.01.	4
	CURRENT	See parameter 15.01.	5
	TORQUE	See parameter 15.01.	6

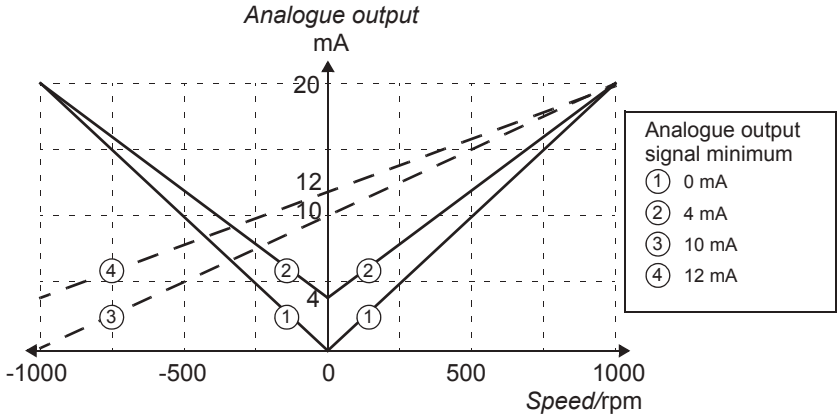
Index	Name/Selection	Description	FbEq
	POWER	See parameter 15.01.	7
	DC BUS VOLT	See parameter 15.01.	8
	OUTPUT VOLT	See parameter 15.01.	9
	APPL OUTPUT	See parameter 15.01.	10
	REFERENCE	See parameter 15.01.	11
	CONTROL DEV	See parameter 15.01.	12
	ACTUAL 1	See parameter 15.01.	13
	ACTUAL 2	See parameter 15.01.	14
	COM.REF4	See parameter 15.01.	15
	PARAM 96.11	Source selected by parameter 96.11.	16
96.02	INVERT EXT AO1	Activates the inversion of analogue output AO1 of the analogue I/O extension module.	
	NO	Inactive	0
	YES	Active. The analogue signal is at a minimum level when the drive signal indicated is at its maximum and vice versa.	65535
96.03	MINIMUM EXT AO1	<p>Defines the minimum value for the analogue output AO1 of the analogue I/O extension module.</p> <p>Note: Actually, the setting 10 mA or 12 mA does not set the AO1 minimum but fixes 10/12 mA to actual signal value zero.</p> <p>Example: Motor speed is read through the analogue output.</p> <ul style="list-style-type: none"> - The motor nominal speed is 1000 rpm (parameter 99.08). - 96.02 is NO. - 96.05 is 100%. <p>The analogue output value as a function of the speed is shown below.</p> 	
	0 mA	0 mA	1
	4 mA	4 mA	2
	10 mA	10 mA	3
	12 mA	12 mA	4
96.04	FILTER EXT AO1	Defines the filtering time constant for analogue output AO1 of the analogue I/O extension module. See parameter 15.04.	
	0.00 ... 10.00 s	Filtering time constant	0 ... 1000
96.05	SCALE EXT AO1	Defines the scaling factor for analogue output AO1 of the analogue I/O extension module. See parameter 15.05.	

Index	Name/Selection	Description	FbEq
	10 ... 1000%	Scaling factor	100 ... 10000
96.06	EXT AO2	Selects the signal connected to analogue output AO2 of the analogue I/O extension module.	
	NOT USED	See parameter 15.01 .	1
	P SPEED	See parameter 15.01 .	2
	SPEED	See parameter 15.01 .	3
	FREQUENCY	See parameter 15.01 .	4
	CURRENT	See parameter 15.01 .	5
	TORQUE	See parameter 15.01 .	6
	POWER	See parameter 15.01 .	7
	DC BUS VOLT	See parameter 15.01 .	8
	OUTPUT VOLT	See parameter 15.01 .	9
	APPL OUTPUT	See parameter 15.01 .	10
	REFERENCE	See parameter 15.01 .	11
	CONTROL DEV	See parameter 15.01 .	12
	ACTUAL 1	See parameter 15.01 .	13
	ACTUAL 2	See parameter 15.01 .	14
	COM.REF5	See parameter 15.06 .	15
	PARAM 96.12	Source selected by parameter 96.12 .	16
96.07	INVERT EXT AO2	Activates the inversion of analogue output AO2 of the analogue I/O extension module. The analogue signal is at its minimum level when the drive signal indicated is at its maximum and vice versa.	
	NO	Inactive	0
	YES	Active	65535
96.08	MINIMUM EXT AO2	Defines the minimum value for analogue output AO2 of the analogue I/O extension module. See parameter 96.03 .	
	0 mA	0 mA	1
	4 mA	4 mA	2
	10 mA	10 mA	3
	12 mA	12 mA	4
96.09	FILTER EXT AO2	Defines the filtering time constant for analogue output AO2 of the analogue I/O extension module. See parameter 15.04 .	
	0.00 ... 10.00 s	Filtering time constant	0 ... 1000
96.10	SCALE EXT AO2	Defines the scaling factor for analogue output AO2 of the analogue I/O extension module. See parameter 15.05 .	
	10 ... 1000%	Scaling factor	100 ... 10000
96.11	EXT AO1 PTR	Defines the source or constant for value PAR 96.11 of parameter 96.01 .	1000 = 1 mA
	-255.255.31 ... +255.255.31 / C.- 32768 ... C.32767	Parameter index or a constant value. See parameter 10.04 for information on the difference.	-

Index	Name/Selection	Description	FbEq
96.12	EXT AO2 PTR	Defines the source or constant for value PAR 96.12 of parameter 96.06.	1000 = 1 mA
	-255.255.31 ... +255.255.31 / C.- 32768 ... C.32767	Parameter index or a constant value. See parameter 10.04 for information on the difference.	-
98 OPTION MODULES		Activation of the option modules. The parameter settings will remain the same even though the application macro is changed (parameter 99.02).	
98.01	ENCODER MODULE	Activates the communication to the optional pulse encoder module. See also parameter group 50 ENCODER MODULE.	
	NTAC	Communication active. Module type: NTAC module. Connection interface: Fibre optic DDCS link. Note: Module node number must be set to 16. For directions, see the <i>NTAC-0x/NDIO-0x/NAIO-0x Module Installation and Start-up Guide</i> [3AFY58919730 (English)].	0
	NO	Inactive	1
	RTAC-SLOT1	Communication active. Module type: RTAC. Connection interface: Option slot 1 of the drive.	2
	RTAC-SLOT2	Communication active. Module type: RTAC. Connection interface: Option slot 2 of the drive.	3
	RTAC-DDCS	Communication active. Module type: RTAC. Connection interface: Optional I/O module adapter (AIMA) that communicates with the drive through a fibre optic DDCS link. Note: Module node number must be set to 16. For directions, see the <i>RTAC-01 Pulse Encoder Interface User's Manual</i> [3AFE64486853 (English)].	4
	RRIA-SLOT1	Communication active. Module type: RRIA. Connection interface: option slot 1 of the drive.	5
	RRIA-SLOT2	Communication active. Module type: RRIA. Connection interface: option slot 2 of the drive.	6
	RRIA-DDCS	Communication active. Module type: RRIA. Connection interface: Optional I/O module adapter (AIMA) that communicates with the drive through a fibre optic DDCS link. Note: Module node number must be set to 16. For directions, see <i>RRIA-01 Resolver Interface Module User's Manual</i> [3AFE68570760 (English)].	7
	RTAC03-SLOT1	Communication active. Module type: RTAC-03. Connection interface: Option slot 1 of the drive.	
	RTAC03-SLOT2	Communication active. Module type: RTAC-03. Connection interface: Option slot 2 of the drive.	
	RTAC03-DDCS	Communication active. Module type: RTAC-03. Connection interface: Optional I/O module adapter (AIMA) that communicates with the drive through a fibre optic DDCS link. Note: Module node number must be set to 16. For directions, see the <i>RTAC-03 Pulse Encoder Interface User's Manual</i> [3AFE68650500 (English)].	
98.02	COMM. MODULE LINK	Activates the external serial communication and selects the interface. See chapter <i>Fieldbus control</i> .	
	NO	No communication	1
	FIELDBUS	The drive communicates through an Rxxx type fieldbus adapter connected to slot 1 or through an Nxxx type fieldbus adapter connected to RMIO board channel CH0. See also parameter group 51 COMM MODULE DATA.	2

Index	Name/Selection	Description	FbEq
	ADVANT	The drive communicates with an ABB Advant OCS system via CH0 on the RDCO board (optional). See also parameter group 70 DDCS CONTROL .	3
	STD MODBUS	The drive communicates with a Modbus controller via the Modbus Adapter Module (RMBA) in option slot 1 of the drive. See also parameter 52 STANDARD MODBUS .	4
	CUSTOMISED	The drive communicates via a customer specified link. The control sources are defined by parameters 90.04 and 90.05 .	5
98.03	DI/O EXT MODULE 1	Activates the communication to the digital I/O extension module 1 (optional) and defines the type and connection interface of the module. Module inputs: See parameter 98.09 for the use of the inputs in the drive application program. Module outputs: See parameters 14.10 and 14.11 for selecting the drive states that are indicated through the relay outputs.	
	NDIO	Communication active. Module type: NDIO module. Connection interface: Fibre optic DDCS link. Note: Module node number must be set to 2. For directions, see the <i>NTAC-0x/NDIO-0x/NAIO-0x Module Installation and Start-up Guide</i> [3AFY58919730 (English)].	1
	NO	Inactive	2
	RDIO-SLOT1	Communication active. Module type: RDIO. Connection interface: Option slot 1 of the drive.	3
	RDIO-SLOT2	Communication active. Module type: RDIO. Connection interface: Option slot 2 of the drive.	4
	RDIO-DDCS	Communication active. Module type: RDIO. Connection interface: Optional I/O module adapter (AIMA) that communicates with the drive through a fibre optic DDCS link. Note: Module node number must be set to 2. For directions, see the <i>RDIO Module User's Manual</i> [3AFE64485733 (English)].	5
98.04	DI/O EXT MODULE 2	Activates the communication to the digital I/O extension module 2 (optional) and defines the type and connection interface of the module. Module inputs: See parameter 98.10 for the use of the inputs in the drive application program. Module outputs: See parameters 14.12 and 14.13 for selecting the drive states that are indicated through the relay outputs.	
	NDIO	Communication active. Module type: NDIO module. Connection interface: Fibre optic DDCS link. Note: Module node number must be set to 3. For directions, see the <i>NTAC-0x/NDIO-0x/NAIO-0x Module Installation and Start-up Guide</i> [3AFY58919730 (English)].	1
	NO	Inactive	2
	RDIO-SLOT1	Communication active. Module type: RDIO. Connection interface: Option slot 1 of the drive.	3
	RDIO-SLOT2	Communication active. Module type: RDIO. Connection interface: Option slot 2 of the drive.	4
	RDIO-DDCS	Communication active. Module type: RDIO. Connection interface: Optional I/O module adapter (AIMA) that communicates with the drive through a fibre optic DDCS link. Note: Module node number must be set to 3. For directions, see the <i>RDIO Module User's Manual</i> [3AFE64485733 (English)].	5

Index	Name/Selection	Description	FbEq
98.05	DI/O EXT MODULE 3	Activates the communication to the digital I/O extension module 3 (optional) and defines the type and connection interface of the module. Module inputs: See parameter 98.11 for the use of the inputs in the drive application program. Module outputs: See parameters 14.14 and 14.15 for selecting the drive states that are indicated through the relay outputs.	
	NDIO	Communication active. Module type: NDIO module. Connection interface: Fibre optic DDCS link. Note: Module node number must be set to 4. For directions, see the <i>NTAC-0x/NDIO-0x/NAIO-0x Module Installation and Start-up Guide</i> [3AFY58919730 (English)].	1
	NO	Inactive	2
	RDIO-SLOT1	Communication active. Module type: RDIO. Connection interface: Option slot 1 of the drive.	3
	RDIO-SLOT2	Communication active. Module type: RDIO. Connection interface: Option slot 2 of the drive.	4
	RDIO-DDCS	Communication active. Module type: RDIO. Connection interface: Optional I/O module adapter (AIMA) that communicates with the drive through a fibre optic DDCS link. Note: Module node number must be set to 4. For directions, see the <i>RDIO Module User's Manual</i> [3AFE64485733 (English)].	5
98.06	AI/O EXT MODULE	Activates the communication to the analogue I/O extension module (optional), and defines the type and connection interface of the module. Module inputs: - Values AI5 and AI6 in the drive application program are connected to module inputs 1 and 2. - See parameters 98.13 and 98.14 for the signal type definitions. Module outputs: - See parameters 96.01 and 96.06 for selecting the drive signals that are indicated through module outputs 1 and 2.	
	NAIO	Communication active. Module type: NAIO. Connection interface: Fibre optic DDCS link. Note: Module node number must be set to 5. For directions, see the <i>NTAC-0x/NDIO-0x/NAIO-0x Module Installation and Start-up Guide</i> [3AFY58919730 (English)].	1
	NO	Communication inactive	2
	RAIO-SLOT1	Communication active. Module type: RAIO. Connection interface: Option slot 1 of the drive.	3
	RAIO-SLOT2	Communication active. Module type: RAIO. Connection interface: Option slot 2 of the drive.	4
	RAIO-DDCS	Communication active. Module type: RAIO. Connection interface: Optional I/O module adapter (AIMA) that communicates with the drive through a fibre optic DDCS link. Note: Module node number must be set to 5. For directions, see the <i>RAIO Module User's Manual</i> [3AFE64484567 (English)].	5
98.07	COMM PROFILE	Defines the profile on which the communication with the fieldbus or another drive is based. Visible only when fieldbus communication is activated by parameter 98.02.	
	ABB DRIVES	ABB Drives profile	1



Index	Name/Selection	Description	FbEq
	GENERIC	Generic drive profile. Typically used with the fieldbus modules that have the type designation of form Rxxx (installed in the option slot of the drive).	2
	CSA 2.8/3.0	Communication profile used by application program versions 2.8 and 3.0.	3
98.09	DI/O EXT1 DI FUNC	Defines the naming of the inputs of digital I/O extension module 1 in the drive application program. See parameter 98.03.	
	DI7,8	DI1 and DI2 of the module extend the number of input channels. The module inputs are named DI7 and DI8.	1
	REPL DI1,2	DI1 and DI2 of the module replace the standard input channels DI1 and DI2. The inputs are named DI1 and DI2.	2
	DI7,8,9	DI1, DI2 and DI3 of the module extend the number of input channels. The module inputs are named DI7, DI8 and DI9.	3
	REPL DI1,2,3	DI1, DI2 and DI3 of the module replace the standard input channels DI1, DI2 and DI3. The inputs are named DI1, DI2 and DI3.	4
98.10	DI/O EXT2 DI FUNC	Defines the naming of the inputs of digital I/O extension module 2 in the drive application program. See parameter 98.04.	
	DI9,10	DI1 and DI2 of the module extend the number of input channels. The module inputs are named DI9 and DI10.	1
	REPL DI3,4	DI1 and DI2 of the module replace the standard input channels DI3 and DI4. The inputs are named DI3 and DI4.	2
	DI10,11,12	DI1, DI2 and DI3 of the module extend the number of input channels. The module inputs are named DI10, DI11 and DI12.	3
	REPL DI4,5,6	DI1, DI2 and DI3 of the module replace the standard input channels DI1, DI2 and DI3. The inputs are named DI4, DI5 and DI6.	4
98.11	DI/O EXT3 DI FUNC	Defines the naming of the inputs of digital I/O extension module 3 in the drive application program. See parameter 98.05.	
	DI11,12	DI1 and DI2 of the module extend the number of input channels. The module inputs are named DI11 and DI12.	1
	REPL DI5,6	DI1 and DI2 of the module replace the standard input channels DI5 and DI6. The inputs are named DI5 and DI6.	2

Index	Name/Selection	Description	FbEq												
98.12	AI/O MOTOR TEMP	<p>Activates the communication to the analogue I/O extension module and reserves the module for the use of the motor temperature measurement function. The parameter also defines the type and connection interface of the module.</p> <p>For more information on the temperature measurement function, see parameter group 35 MOT TEMP MEAS and section Motor temperature measurement through an analogue I/O extension on page 75.</p> <p>The use of the analogue inputs (AI) and outputs (AO) of the module is shown in the table below.</p> <table border="1" style="width: 100%; border-collapse: collapse;"> <thead> <tr> <th colspan="2">Motor 1 temperature measurement</th> </tr> </thead> <tbody> <tr> <td style="width: 10%;">AO1</td> <td>Feeds a constant current to motor 1 temperature sensor. The current value depends on the setting of parameter 35.01: - AO1 is 9.1 mA with selection 1xPT100 - AO1 is 1.6 mA with selection 1...3 PTC</td> </tr> <tr> <td>AI1</td> <td>Measures voltage over motor 1 temperature sensor.</td> </tr> <tr> <th colspan="2">Motor 2 temperature measurement</th> </tr> <tr> <td>AO2</td> <td>Feeds a constant current to motor 2 temperature sensor. The current value depends on the setting of parameter 35.04: - AO2 is 9.1 mA with selection 1xPT100, - AO2 is 1.6 mA with selection 1...3 PTC</td> </tr> <tr> <td>AI2</td> <td>Measures voltage over motor 2 temperature sensor.</td> </tr> </tbody> </table> <p>Before setting the drive parameters, ensure the module hardware settings are appropriate for the motor temperature measurement:</p> <ol style="list-style-type: none"> The module node number is 9. The input signal type selections are the following: <ul style="list-style-type: none"> - for one Pt 100 sensor measurement, set the range to 0 ... 2 V. - for two to three Pt 100 sensors or one to three PTC sensors, set the range to 0 ... 10 V. The operation mode selection is unipolar. 	Motor 1 temperature measurement		AO1	Feeds a constant current to motor 1 temperature sensor. The current value depends on the setting of parameter 35.01 : - AO1 is 9.1 mA with selection 1xPT100 - AO1 is 1.6 mA with selection 1...3 PTC	AI1	Measures voltage over motor 1 temperature sensor.	Motor 2 temperature measurement		AO2	Feeds a constant current to motor 2 temperature sensor. The current value depends on the setting of parameter 35.04 : - AO2 is 9.1 mA with selection 1xPT100 , - AO2 is 1.6 mA with selection 1...3 PTC	AI2	Measures voltage over motor 2 temperature sensor.	
Motor 1 temperature measurement															
AO1	Feeds a constant current to motor 1 temperature sensor. The current value depends on the setting of parameter 35.01 : - AO1 is 9.1 mA with selection 1xPT100 - AO1 is 1.6 mA with selection 1...3 PTC														
AI1	Measures voltage over motor 1 temperature sensor.														
Motor 2 temperature measurement															
AO2	Feeds a constant current to motor 2 temperature sensor. The current value depends on the setting of parameter 35.04 : - AO2 is 9.1 mA with selection 1xPT100 , - AO2 is 1.6 mA with selection 1...3 PTC														
AI2	Measures voltage over motor 2 temperature sensor.														
	NAIO	<p>Communication active. Module type: NAIO. Connection interface: Fibre optic DDCS link.</p> <p>Note: Make the module hardware settings as described above. For instructions, see the <i>NTAC-0x/NDIO-0x/NAIO-0x Module Installation and Start-up Guide</i> [3AFY58919730 (English)].</p>	1												
	NO	Inactive	2												
	RAIO-SLOT1	<p>Communication active. Module type: RAIO. Connection interface: Option slot 1 of the drive.</p> <p>Note: Make the module hardware settings as described above. The node number is not required. For directions, see the <i>RAIO Module User's Manual</i> [3AFE64484567 (English)].</p>	3												
	RAIO-SLOT2	<p>Communication active. Module type: RAIO. Connection interface: Option slot 2 of the drive.</p> <p>Note: Make the module hardware settings as described above. The node number is not required. For directions, see the <i>RAIO Module User's Manual</i> [3AFE64484567 (English)].</p>	4												

Index	Name/Selection	Description	FbEq
	RAIO-DDCS	Communication active. Module type: RAIO. Connection interface: Optional I/O module adapter (AIMA) that communicates with the drive through a fibre optic DDCS link. Note: Set the module node number to 9. For directions, see the <i>RAIO Module User's Manual</i> [3AFE64484567 (English)].	5
98.13	AI/O EXT AI1 FUNC	Defines the signal type for input 1 of the analogue I/O extension module (AI5 in the drive application program). The setting must match the signal connected to the module. Note: The communication must be activated by parameter 98.06.	
	UNIPOLAR AI5	Unipolar	1
	BIPOLAR AI5	Bipolar	2
98.14	AI/O EXT AI2 FUNC	Defines the signal type for input 2 of the analogue I/O extension module (AI6 in the drive application program). The setting must match the signal connected to the module. Note: The communication must be activated by parameter 98.06.	
	UNIPOLAR AI6	Unipolar	1
	BIPOLAR AI6	Bipolar	2
98.16	SIN FILT SUPERV	Activates the communication to the digital I/O extension module and reserves the module for the use of the sine-filter temperature measurement. Parameter is visible if parameter 95.04 is set to SIN or EX&SIN. Parameter value is automatically set to NO, when parameter 95.04 value is changed. Note: This parameter is used only in special applications.	
	NDIO	Module type: NDIO module. Connection interface: Fibre optic DDCS link. Note: Module node number must be set to 8. For directions see the <i>NTAC-0x/NDIO-0x/NAIO-0x Module Installation and Start-up Guide</i> [3AFY58919730 (English)].	1
	NO	Supervision disabled.	2
	RDIO-SLOT1	Module type: RDIO. Connection interface: Option slot 1 of the drive.	3
	RDIO-SLOT2	Module type: RDIO. Connection interface: Option slot 2 of the drive.	4
	RDIO-DDCS	Module type: RDIO. Connection interface: Optional I/O module adapter (AIMA) that communicates with the drive through a fibre optic DDCS link. Note: Module node number must be set to 8. For directions, see the <i>RDIO Module User's Manual</i> [3AFE64485733 (English)].	5
99 START-UP DATA		Language selection. Definition of motor set-up data.	
99.01	LANGUAGE	Selects the display language.	
	ENGLISH	British English	0
	ENGLISH AM	American English. If selected, the unit of power used is HP instead of kW.	1
	DEUTSCH	German	2
	ITALIANO	Italian	3
	ESPAÑOL	Spanish	4
	PORTUGUES	Portuguese	5
	NEDERLANDS	Dutch	6
	FRANCAIS	French	7
	DANSK	Danish	8
	SUOMI	Finnish	9
	SVENSKA	Swedish	10

Index	Name/Selection	Description	FbEq
	CESKY	Czech	11
	POLSKI/LOC1	Polish	12
	PO-RUS/LOC2	Russian	13
99.02	APPLICATION MACRO	<p>Selects the application macro. See chapter Application macros for more information.</p> <p>Note: When you change the default parameter values of a macro, the new settings become valid immediately and stay valid even if the power of the drive is switched off and on. However, backup of the default parameter settings (factory settings) of each standard macro is still available. See parameter 99.03.</p>	
	FACTORY	Factory for basic applications	1
	HAND/AUTO	<p>Two control devices are connected to the drive:</p> <ul style="list-style-type: none"> - device 1 communicates through the interface defined by external control location EXT1. - device 2 communicates through the interface defined by external control location EXT2. - EXT1 or EXT2 is active at a time. Switching through a digital input. 	2
	PID-CTRL	<p>PID control. For application in which the drive controls a process value. E.g. pressure control by the drive running the pressure boost pump. Measured pressure and the pressure reference are connected to the drive.</p> <p>See sections Process PID control on page 70 and Sleep function for the process PID control on page 71.</p>	3
	T-CTRL	Torque Control macro	4
	SEQ CTRL	Sequential Control macro. For applications that are frequently run through a pre-defined speed pattern (constant speeds and acceleration and deceleration ramps).	5
	USER 1 LOAD	User 1 macro loaded into use. Before loading, check that the saved parameter settings and the motor model are suitable for the application.	6
	USER 1 SAVE	<p>Save User 1 macro. Stores the current parameter settings and the motor model.</p> <p>Note: There are parameters that are not included in the macros. See parameter 99.03.</p>	7
	USER 2 LOAD	User 2 macro loaded into use. Before loading, check that the saved parameter settings and the motor model are suitable for the application.	8
	USER 2 SAVE	<p>Save User 2 macro. Stores the current parameter settings and the motor model.</p> <p>Note: There are parameters that are not included in the macros. See parameter 99.03.</p>	9
99.03	APPLIC RESTORE	<p>Restores the original settings of the active application macro (99.02).</p> <ul style="list-style-type: none"> - If a standard macro (Factory, ... , Sequential Control) is active, the parameter values are restored to the default settings (factory settings). Exceptions: parameter settings in parameter group 99 remain unchanged. The motor model remains unchanged. - If User Macro 1 or 2 is active, the parameter values are restored to the last saved values. In addition, the last saved motor model are restored. Exceptions: Settings of parameters 16.05 and 99.02 remain unchanged. <p>Note: The parameter settings and the motor model are restored according to the same principles when a macro is changed to another.</p>	
	NO	No action	0

Index	Name/Selection	Description	FbEq
	YES	Restoring	65535
99.04	MOTOR CTRL MODE	Selects the motor control mode.	
	DTC	Direct Torque Control mode is suitable for most applications.	0
	SCALAR	<p>Scalar control is suitable in special cases where the DTC cannot be applied. The scalar control mode is recommended:</p> <ul style="list-style-type: none"> - for multimotor drives with variable number of motors - when the nominal current of the motor is less than 1/6 of the nominal output current of the drive (inverter) - the drive is used for test purposes with no motor connected. <p>Note: The outstanding motor control accuracy of the DTC cannot be achieved in scalar control. The differences between the scalar and DTC control modes are pointed out in this manual in relevant parameter lists. There are some standard features that are disabled in the scalar control mode: Motor Identification Run (group 99 START-UP DATA), Speed Limits (group 20 LIMITS), Torque Limit (group 20 LIMITS), DC Hold (group 21 START/STOP), DC Magnetizing (group 21 START/STOP), Speed Controller Tuning (group 23 SPEED CTRL), Torque Control (group 24 TORQUE CTRL), Flux Optimization (group 26 MOTOR CONTROL), Flux Braking (group 26 MOTOR CONTROL), Underload Function (group 30 FAULT FUNCTIONS), Motor Phase Loss Protection (group 30 FAULT FUNCTIONS), Motor Stall Protection (group 30 FAULT FUNCTIONS).</p> <p>For more information, see section Scalar control on page 62.</p>	65535
99.05	MOTOR NOM VOLTAGE	Defines the nominal motor voltage. Must be equal to the value on the motor rating plate.	
	$1/2 \dots 2 \cdot U_N$	<p>Voltage. Allowed range is $1/2 \dots 2 \cdot U_N$ of the drive.</p> <p>Note: The stress on the motor insulations is always dependent on the drive supply voltage. This also applies to the case where the motor voltage rating is lower than the rating of the drive and the supply of the drive.</p>	$1 = 1 \text{ V}$
99.06	MOTOR NOM CURRENT	Defines the nominal motor current. Must be equal to the value on the motor rating plate. If several motors are connected to the inverter, enter the total current of the motors.	
	$0 \dots 2 \cdot I_{2hd}$	<p>Allowed range: approx. $1/6 \dots 2 \cdot I_{2hd}$ of ACS800 (parameter 99.04 = DTC).</p> <p>Allowed range: approx. $0 \dots 2 \cdot I_{2hd}$ of ACS800 (parameter 99.04 = SCALAR).</p>	$1 = 0.1 \text{ A}$
99.07	MOTOR NOM FREQ	Defines the nominal motor frequency.	
	8 ... 300 Hz	Nominal frequency (50 or 60 Hz typically)	800 ... 30000
99.08	MOTOR NOM SPEED	Defines the nominal motor speed. Must be equal to the value on the motor rating plate. The motor synchronous speed or another approximate value must not be given instead!	
	1 ... 18000 rpm	Nominal motor speed	1 ... 18000
99.09	MOTOR NOM POWER	Defines the nominal motor power. Set exactly as on the motor rating plate. If several motors are connected to the inverter, enter the total power of the motors.	
	0 ... 9000 kW	Nominal motor power	0 ... 90000

Index	Name/Selection	Description	FbEq
99.10	MOTOR ID RUN MODE	<p>Selects the type of the motor identification. During the identification, the drive will identify the characteristics of the motor for optimum motor control. The ID Run Procedure is described in chapter Start-up and control through the I/O.</p> <p>Note: The ID Run (STANDARD or REDUCED) should be selected if:</p> <ul style="list-style-type: none"> - The operation point is near zero speed, and/or - Operation at torque range above the motor nominal torque within a wide speed range and without any measured speed feedback is required. <p>Note: The ID Run (STANDARD or REDUCED) cannot be performed if parameter 99.04 = SCALAR.</p> <p>See section Motor identification on page 53.</p>	
	ID MAGN	No ID Run. The motor model is calculated at first start by magnetising the motor for 20 to 60 s at zero speed. This can be selected in most applications.	1
	STANDARD	<p>Standard ID Run. Guarantees the best possible control accuracy. The ID Run takes about one minute.</p> <p>Note: The motor must be de-coupled from the driven equipment.</p> <p>Note: Check the direction of rotation of the motor before starting the ID Run. During the run, the motor will rotate in the forward direction.</p> <p> WARNING! The motor will run at up to approximately 50 ... 80% of the nominal speed during the ID Run. ENSURE THAT IT IS SAFE TO RUN THE MOTOR BEFORE PERFORMING THE ID RUN!</p>	2
	REDUCED	<p>Reduced ID Run. Should be selected instead of the Standard ID Run:</p> <ul style="list-style-type: none"> - if mechanical losses are higher than 20% (i.e. the motor cannot be de-coupled from the driven equipment) - if flux reduction is not allowed while the motor is running (i.e. in case of a motor with an integrated brake supplied from the motor terminals). <p>Note: Check the direction of rotation of the motor before starting the ID Run. During the run, the motor will rotate in the forward direction.</p> <p> WARNING! The motor will run at up to approximately 50 ... 80% of the nominal speed during the ID Run. ENSURE THAT IT IS SAFE TO RUN THE MOTOR BEFORE PERFORMING THE ID RUN!</p>	3
99.11	DEVICE NAME	Defines the name for the drive or application. The name is visible on the control panel display in the Drive Selection Mode. Note: The name can be typed only by using a drive PC tool.	

www.nicsanat.com

021-87700210

NIC SANAT

نیک صنعت



Fieldbus control

Chapter overview

The chapter describes how the drive can be controlled by external devices over a communication network.

System overview

The drive can be connected to an external control system – usually a fieldbus controller – via an adapter module. The drive can be set to receive all of its control information through the external control interface, or the control can be distributed between the external control interface and other available sources, for example digital and analogue inputs. The following diagram shows the control interfaces and I/O connections of the drive.

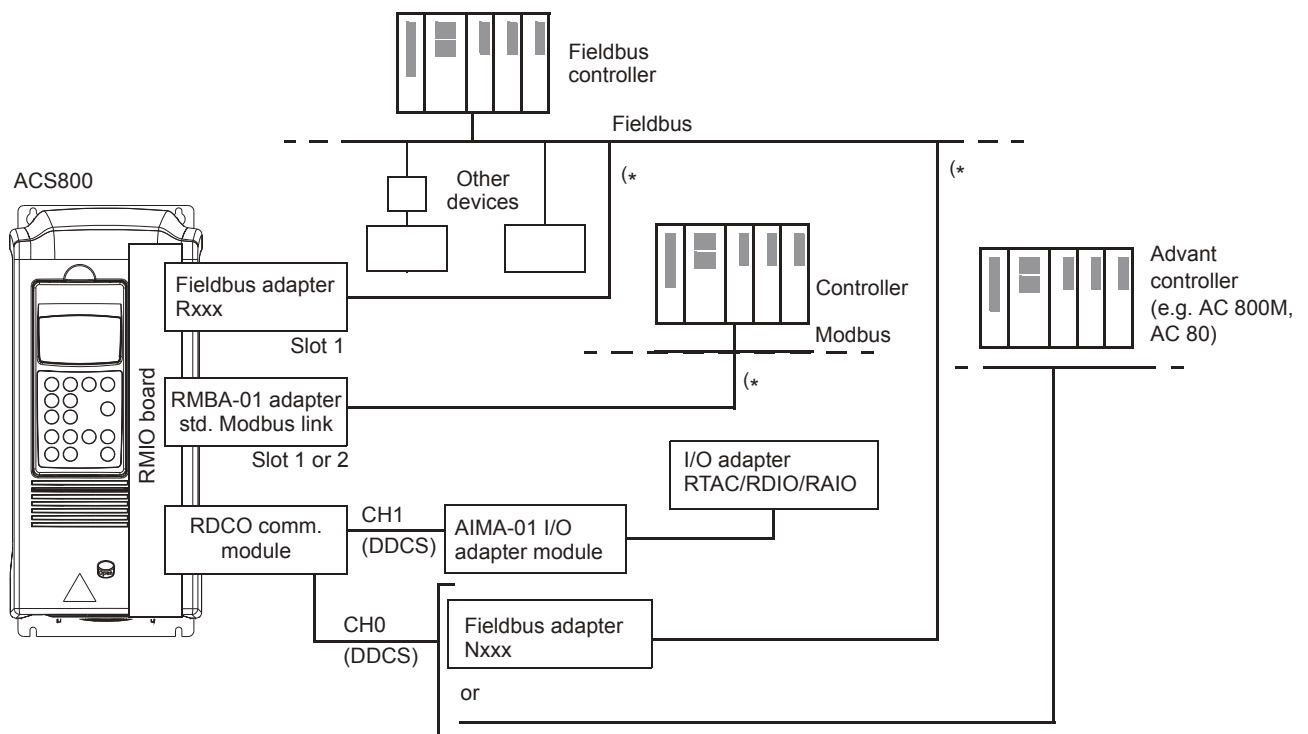

Data Flow

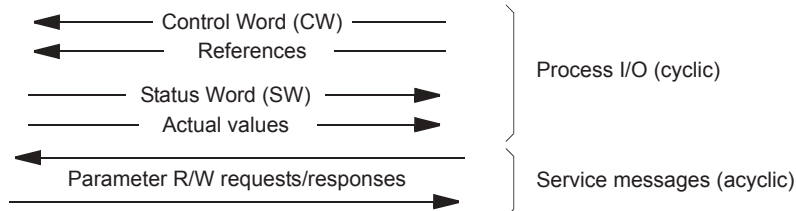

(* Either an Rxxx or Nxxx, and an RMBA-01 adapter can be connected to the drive simultaneously.)

Redundant fieldbus control

It is possible to connect two fieldbuses to the drive with the following adapter configuration:

- Type Rxxx fieldbus adapter module (not RMBA-01) is installed in drive slot 1.
- RMBA-01 Modbus Adapter module is installed in drive slot 2.

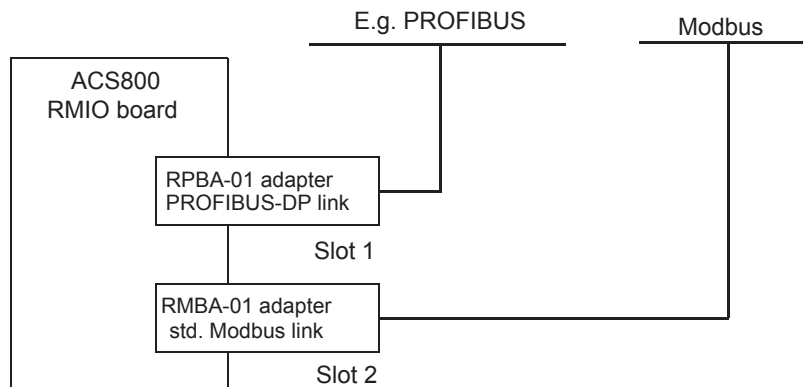

The control (i.e. the Main Reference data set, see section [The fieldbus control interface](#) on page 202) is activated by setting parameter 98.02 to FIELDBUS or STD MODBUS.

In case there is a communication problem with one fieldbus, the control can be switched to the other fieldbus. Switching between the buses can be controlled e.g. with adaptive programming. Parameters and signals can be read by both fieldbuses, but simultaneous cyclical writing to the same parameter is forbidden.

Setting up communication through a fieldbus adapter module

Fieldbus adapters for several communication protocols are available (e.g. PROFIBUS® and Modbus®). Rxxx type fieldbus adapter modules are mounted in expansion slot 1 of the drive. Nxxx type fieldbus adapter modules are connected to channel CH0 of the RDCO module.

Note: For instructions on setting up an RMBA-01 module, see section [Setting up communication through the Standard Modbus Link](#) on page 195.

Before configuring the drive for fieldbus control, the adapter module must be mechanically and electrically installed according to the instructions given in the hardware manual of the drive, and the module manual.

The following table lists the parameters which need to be defined when setting up communication through a fieldbus adapter.

Parameter	Alternative settings	Setting for fieldbus control	Function/Information
COMMUNICATION INITIALISATION			
98.02	NO FIELDBUS ADVANT STD MODBUS CUSTOMISED	FIELDBUS	Initialises communication between drive and fieldbus adapter module. Activates module set-up parameters (Group 51).
98.07	ABB DRIVES GENERIC CSA 2.8/3.0	ABB DRIVES GENERIC or CSA 2.8/3.0	Selects the communication profile used by the drive. See section Communication profiles on page 210.
ADAPTER MODULE CONFIGURATION			
51.01 MODULE TYPE	–	–	Displays the type of the fieldbus adapter module.
51.02 (FIELDBUS PARAMETER 2)	These parameters are adapter module-specific. For more information, see the module manual. Note that not all of these parameters are necessarily visible.		
...			
51.26 (FIELDBUS PARAMETER 26)			
51.27 FBA PAR REFRESH*	(0) DONE (1) REFRESH	–	Validates any changed adapter module configuration parameter settings. After refreshing, the value reverts automatically to DONE.
51.28 FILE CPI FW REV*	xyz (binary coded decimal)	–	Displays the required CPI firmware revision of the fieldbus adapter as defined in the configuration file stored in the memory of the drive. The CPI firmware version of the fieldbus adapter (refer to par. 51.32) must contain the same or a later CPI version to be compatible. x = major revision number; y = minor revision number; z = correction number. Example: 107 = revision 1.07.

Parameter	Alternative settings	Setting for fieldbus control	Function/Information
51.29 FILE CONFIG ID*	xyz (binary coded decimal)	–	Displays the fieldbus adapter module configuration file identification stored in the memory of the drive. This information is drive application program-dependent.
51.30 FILE CONFIG REV*	xyz (binary coded decimal)	–	Displays the fieldbus adapter module configuration file revision stored in the memory of the drive. x = major revision number; y = minor revision number; z = correction number. Example: 1 = revision 0.01.
51.31 FBA STATUS*	(0) IDLE (1) EXEC. INIT (2) TIME OUT (3) CONFIG ERROR (4) OFF-LINE (5) ON-LINE (6) RESET	–	Displays the status of the adapter module. IDLE = Adapter not configured. EXEC. INIT = Adapter initialising. TIME OUT = A timeout has occurred in the communication between the adapter and the drive. CONFIG ERROR = Adapter configuration error. The major or minor revision code of the CPI program revision in the drive is not the revision required by the module (refer to par. 51.32) or configuration file upload has failed more than five times. OFF-LINE = Adapter is off-line. ON-LINE = Adapter is on-line. RESET = Adapter performing a hardware reset.
51.32 FBA CPI FW REV*	–	–	Displays the CPI program revision of the module inserted in slot 1. x = major revision number; y = minor revision number; z = correction number. Example: 107 = revision 1.07.
51.33 FBA APPL FW REV*	–	–	Displays the application program revision of the module inserted in slot 1. x = major revision number; y = minor revision number; z = correction number. Example: 107 = revision 1.07.

*Parameters 51.27 to 51.33 are only visible when type Rxxx fieldbus adapter is installed.

After the module configuration parameters in group 51 have been set, the drive control parameters (section [Drive control parameters](#) on page 199) must be checked and adjusted where necessary.

The new settings will take effect when the drive is next powered up, or when parameter 51.27 is activated.

Setting up communication through the Standard Modbus Link

An RMBA-01 Modbus Adapter installed in slot 1 or 2 of the drive forms an interface called the Standard Modbus Link. The Standard Modbus Link can be used for external control of the drive by a Modbus controller (RTU protocol only).

Before configuring the drive for Modbus control, the adapter module must be mechanically and electrically installed according to the instructions given in the hardware manual of the drive, and the module manual.

The following table lists the parameters, which need to be defined when setting up communication through the standard Modbus link.

Parameter	Alternative settings	Setting for control through Standard Modbus Link	Function/Information
COMMUNICATION INITIALISATION			
98.02	NO FIELD BUS ADVANT STD MODBUS CUSTOMISED	STD MODBUS	Initialises communication between drive (Standard Modbus Link) and Modbus-protocol controller. Activates communication parameters in group 52.
98.07	ABB DRIVES GENERIC CSA 2.8/3.0	ABB DRIVES	Selects the communication profile used by the drive. See section Communication profiles on page 210.
COMMUNICATION PARAMETERS			
52.01	1 to 247	–	Specifies the station number of the drive on the Standard Modbus Link.
52.02	600 1200 2400 4800 9600 19200	–	Defines the communication speed for the Standard Modbus Link.
52.03	ODD EVEN NONE1STOPBIT NONE2STOPBIT	–	Selects the parity setting for the Standard Modbus Link.

After the communication parameters in group 52 have been set, the drive control parameters (section [Drive control parameters](#) on page 199) must be checked and adjusted where necessary.

Modbus addressing

In the Modbus controller memory, the Control Word, the Status Word, the references, and the actual values are mapped as follows:

Data from fieldbus controller to drive		Data from drive to fieldbus controller	
Address	Contents	Address	Contents
40001	Control Word	40004	Status Word
40002	Reference 1	40005	Actual 1
40003	Reference 2	40006	Actual 2
40007	Reference 3	40010	Actual 3
40008	Reference 4	40011	Actual 4
40009	Reference 5	40012	Actual 5

More information on Modbus communication is available from the Modicon website <http://www.modicon.com>.

Setting up communication through Advant controller

The Advant controller is connected via DDCS link to channel CH0 of the RDCO module.

- **AC 800M Advant Controller**

DriveBus connection: CI858 DriveBus Communication Interface required. See CI858 DriveBus Communication Interface User's Manual, [3AFE 68237432 (English)].

Optical ModuleBus connection: TB811 (5 MBd) or TB810 (10 MBd) Optical ModuleBus Port Interface required. See section [Optical ModuleBus connection](#) below.

For more information, see *AC 800M Controller Hardware Manual* [3BSE027941 (English)], *AC 800M/C Communication, Protocols and Design Manual* [3BSE028811 (English),] ABB Industrial Systems, Västerås, Sweden.

- **AC 80 Advant Controller**

Optical ModuleBus connection: TB811 (5 MBd) or TB810 (10 MBd) Optical ModuleBus Port Interface required. See section [Optical ModuleBus connection](#) below.

- **CI810A Fieldbus Communication Interface (FCI)**

Optical ModuleBus connection

TB811 (5 MBd) or TB810 (10 MBd) Optical ModuleBus Port Interface required.

The TB811 Optical ModuleBus Port Interface is equipped with 5 MBd optical components and the TB810 is equipped with 10 MBd components. All optical components on a fibre optic link must be of the same type since 5 MBd components do not match with 10 MBd components. The choice between TB810 and TB811 depends on the equipment it is connected to. With RDCO Communication Option Module, the Interface is selected as follows:

Optional ModuleBus Port Interface	DDCS Communication Option Module		
	RDCO-01	RDCO-02	RDCO-03
TB811		x	x
TB810	x		

If branching unit NDBU-85/95 is used with CI810A, TB810 Optical ModuleBus Port Interface must be used.

The following table lists the parameters which need to be defined when setting up communication between the drive and Advant controller.

Parameter	Alternative settings	Setting for control through CH0	Function/Information
COMMUNICATION INITIALISATION			
98.02	NO FIELDBUS ADVANT STD MODBUS CUSTOMISED	ADVANT	Initialises communication between drive (fibre optic channel CH0) and Advant controller. The transmission speed is 4 Mbit/s.
98.07	ABB DRIVES GENERIC CSA 2.8/3.0	ABB DRIVES	Selects the communication profile used by the drive. See section Communication profiles on page 210.
70.01	0-254	AC 800M ModuleBus $\hat{=}$ 1...125 AC 80 ModuleBus $\hat{=}$ 17-125 FCI (CI810A) $\hat{=}$ 17-125	Defines the node address for DDCCS channel CH0.
70.04	RING STAR		Selects the topology of the channel CH0 link.

After the communication initialisation parameters have been set, the drive control parameters (section [Drive control parameters](#) on page 199) must be checked and adjusted where necessary.

In an Optical ModuleBus connection, channel 0 address (parameter 70.01) is calculated from the value of the POSITION terminal in the appropriate database element (for the AC 80, DRISTD) as follows:

1. Multiply the hundreds of the value of POSITION by 16.
2. Add the tens and ones of the value of POSITION to the result.

For example, if the POSITION terminal of the DRISTD database element has the value of 110 (the tenth drive on the Optical ModuleBus ring), parameter 70.01 must be set to $16 \times 1 + 10 = 26$.

Drive control parameters

After the fieldbus communication has been set up, the drive control parameters listed in the table below must be checked and adjusted where necessary.

The **Setting for fieldbus control** column gives the value to use when the fieldbus interface is the desired source or destination for that particular signal. The **Function/Information** column gives a description of the parameter.

The fieldbus signal routes and message composition are explained later in section [The fieldbus control interface](#) on page 202.

Parameter	Setting for fieldbus control	Function/Information
CONTROL COMMAND SOURCE SELECTION		
10.01	COMM.CW	Enables the fieldbus Control Word (except 03.01 Main Control Word bit 11) when EXT1 is selected as the active control location. See also par. 10.07.
10.02	COMM.CW	Enables the fieldbus Control Word (except 03.01 Main Control Word bit 11) when EXT2 is selected as the active control location.
10.03	FORWARD REVERSE or REQUEST	Enables rotation direction control as defined by parameters 10.01 and 10.02. The direction control is explained in section Reference handling on page 204.
10.07	0 or 1	Setting the value to 1 overrides the setting of par. 10.01 so that the fieldbus Control Word (except 03.01 Main Control Word bit 11) is enabled when EXT1 is selected as the active control location. Note 1: Only visible with the Generic Drive communication profile selected (see par. 98.07). Note 2: Setting not saved into permanent memory.
10.08	0 or 1	Setting the value to 1 overrides the setting of par. 11.03 so that Fieldbus reference REF1 is used when EXT1 is selected as the active control location. Note 1: Only visible with the Generic Drive communication profile selected (see par. 98.07). Note 2: Setting not saved into permanent memory.
11.02	COMM.CW	Enables EXT1/EXT2 selection by fieldbus Control Word bit 11 EXT CTRL LOC.
11.03	COMM.REF1 FAST COMM COM.REF1+AI1 COM.REF1+AI5 COM.REF1*AI1 or COM.REF1*AI5	Fieldbus reference REF1 is used when EXT1 is selected as the active control location. See section References on page 203 for information on the alternative settings.
11.06	COMM.REF2 FAST COMM COM.REF2+AI1 COM.REF2+AI5 COM.REF2*AI1 or COM.REF2*AI5	Fieldbus reference REF2 is used when EXT2 is selected as the active control location. See section References on page 203 for information on the alternative settings.



Parameter	Setting for fieldbus control	Function/Information
OUTPUT SIGNAL SOURCE SELECTION		
14.01	COM.REF3	Enables relay output RO1 control by fieldbus reference REF3 bit 13.
14.02	COM.REF3	Enables relay output RO2 control by fieldbus reference REF3 bit 14.
14.03	COM.REF3	Enables relay output RO3 control by fieldbus reference REF3 bit 15.
15.01	COMM.REF4	Directs the contents of fieldbus reference REF4 to analogue output AO1. Scaling: 20000 = 20 mA
15.06	COMM.REF5	Directs the contents of fieldbus reference REF5 to analogue output AO2. Scaling: 20000 = 20 mA.
SYSTEM CONTROL INPUTS		
16.01	COMM.CW	Enables the control of the Run Enable signal through fieldbus 03.01 Main Control Word bit 3. Note: Must be set to YES when the Generic Drive communication profile is selected (see par. 98.07).
16.04	COMM.CW	Enables fault reset through fieldbus 03.01 Main Control Word bit 7. Note: Reset through fieldbus Control Word (03.01 bit 7) is enabled automatically and it is independent of parameter 16.04 setting if parameter 10.01 or 10.02 is set to COMM.CW.
16.07	DONE; SAVE	Saves parameter value changes (including those made through fieldbus control) to permanent memory.
COMMUNICATION FAULT FUNCTIONS		
30.18	FAULT NO CONST SP15 LAST SPEED	Determines drive action in case fieldbus communication is lost. Note: The communication loss detection is based on monitoring of received Main and Auxiliary data sets (whose sources are selected with parameters 90.04 and 90.05 respectively).
30.19	0.1 ... 60.0 s	Defines the time between Main Reference data set loss detection and the action selected with parameter 30.18.
30.20	ZERO LAST VALUE	Determines the state in which relay outputs RO1 to RO3 and analogue outputs AO1 and AO2 are left upon loss of the Auxiliary Reference data set.
30.21	0.0 ... 60.0 s	Defines the time between Auxiliary Reference data set loss detection and the action selected with parameter 30.18. Note: This supervision function is disabled if this parameter, or parameters 90.01, 90.02 and 90.03 are set to 0.
FIELDBUS REFERENCE TARGET SELECTION		
90.01	0 ... 8999	Defines the drive parameter into which the value of fieldbus reference REF3 is written. Format: xyyy , where xx = parameter group (10 to 89), yy = parameter Index. E.g. 3001 = parameter 30.01.

Parameter	Setting for fieldbus control	Function/Information
90.02	0 ... 8999	Defines the drive parameter into which the value of fieldbus reference REF4 is written. Format: see parameter 90.01.
90.03	0 ... 8999	Defines the drive parameter into which the value of fieldbus reference REF5 is written. Format: see parameter 90.01.
90.04	1 (Fieldbus Control) or 81 (Standard Modbus Control)	If 98.02 is set to CUSTOMISED, this parameter selects the source from which the drive reads the Main Reference data set (comprising the fieldbus Control Word, fieldbus reference REF1, and fieldbus reference REF2).
90.05	3 (Fieldbus Control) or 83 (Standard Modbus Control)	If 98.02 is set to CUSTOMISED, this parameter selects the source from which the drive reads the Auxiliary Reference data set (comprising fieldbus references REF3, REF4 and REF5).

ACTUAL SIGNAL SELECTION FOR FIELDBUS

92.01	302 (Fixed)	The Status Word is transmitted to as the first word of the Main Actual Signal data set.
92.02	0 ... 9999	Selects the Actual signal or parameter value to be transmitted as the second word (ACT1) of the Main Actual Signal data set. Format: (x)xyy, where (x)x = actual signal group or parameter group, yy = actual signal or parameter index. E.g. 103 = actual signal 1.03 FREQUENCY; 2202 = parameter 22.02 ACCEL TIME 1. Note: With the Generic Drive communication profile active (par. 98.07 = GENERIC), this parameter is fixed to 102 (actual signal 1.02 SPEED – in DTC motor control mode) or 103 (1.03 FREQUENCY – in Scalar mode).
92.03	0 ... 9999	Selects the actual signal or parameter value to be transmitted as the third word (ACT2) of the Main Actual Signal data set. Format: see parameter 92.02.
92.04	0 ... 9999	Selects the actual signal or parameter value to be transmitted as the first word (ACT3) of the Auxiliary Actual Signal data set. Format: see parameter 92.02.
92.05	0 ... 9999	Selects the actual signal or parameter value to be transmitted as the second word (ACT4) of the Auxiliary Actual Signal data set. Format: see parameter 92.02.
92.06	0 ... 9999	Selects the actual signal or parameter value to be transmitted as the third word (ACT5) of the Auxiliary Actual Signal data set. Format: see parameter 92.02.
92.07	-255.255.31...+255.255.31 / C.-32768 ... C.32767	Selects the address from which the 03.02 Main Status Word bit 10 is read from.
92.08	-255.255.31...+255.255.31 / C.-32768 ... C.32767	Selects the address from which the 03.02 Main Status Word bit 13 is read from.
92.09	-255.255.31...+255.255.31 / C.-32768 ... C.32767	Selects the address from which the 03.02 Main Status Word bit 14 is read from.

The fieldbus control interface

The communication between a fieldbus system and the drive employs *data sets*. One data set (abbreviated DS) consists of three 16-bit words called data words (DW). The Standard Control Program supports the use of four data sets, two in each direction.

The two data sets for controlling the drive are referred to as the Main Reference data set and the Auxiliary Reference data set. The sources from which the drive reads the Main and Auxiliary Reference data sets are defined by parameters 90.04 and 90.05 respectively. The contents of the Main Reference data set are fixed. The contents of the Auxiliary Reference data set can be selected using parameters 90.01, 90.02 and 90.03.

The two data sets containing actual information on the drive are referred to as the Main Actual Signal data set and the Auxiliary Actual Signal data set. The contents of both data sets are partly selectable with the parameters at group 92.

Data from fieldbus controller to drive		
Word	Contents	Selector

Data from drive to fieldbus controller		
Word	Contents	Selector

*Index	Main Reference data set DS1		
1	1st word	Control Word	(Fixed)
2	2nd word	Reference 1	(Fixed)
3	3rd word	Reference 2	(Fixed)

*Index	Main Actual Signal data set DS2		
4	1st word	Status Word	(Fixed)
5	2nd word	Actual 1	**Par. 92.02
6	3rd word	Actual 2	Par. 92.03

*Index	Auxiliary Reference data set DS3		
7	1st word	Reference 3	Par. 90.01
8	2nd word	Reference 4	Par. 90.02
9	3rd word	Reference 5	Par. 90.03

*Index	Aux. Actual Signal data set DS4		
10	1st word	Actual 3	Par. 92.04
11	2nd word	Actual 4	Par. 92.05
12	3rd word	Actual 5	Par. 92.06

*The index number is required when data word allocation to process data is defined via the fieldbus parameters at group 51. This function is dependent on the type of the fieldbus adapter.

**With the Generic Drive communication profile active, Actual 1 is fixed to actual signal 01.02 SPEED (in DTC motor control mode) or 01.03 FREQUENCY (in Scalar mode).

The update time for the Main Reference and Main Actual Signal data sets is 6 milliseconds; for the Auxiliary Reference and Auxiliary Actual Signal data sets, it is 100 milliseconds.

The Control Word and the Status Word

The Control Word (CW) is the principal means of controlling the drive from a fieldbus system. It is effective when the active control location (EXT1 or EXT2, see parameters 10.01 and 10.02) is set to COMM.CW, or if par. 10.07 is set to 1 (with Generic Drive communication profile only).

The Control Word is sent by the fieldbus controller to the drive. The drive switches between its states according to the bit-coded instructions of the Control Word.

The Status Word (SW) is a word containing status information, sent by the drive to the fieldbus controller.

See section [Communication profiles](#) on page 210 for information on the composition of the Control Word and the Status Word.

References

References (REF) are 16-bit signed integers. A negative reference (indicating reversed direction of rotation) is formed by calculating the two's complement from the corresponding positive reference value.

Fieldbus reference selection and correction

Fieldbus reference (called COM.REF in signal selection contexts) is selected by setting a Reference selection parameter – 11.03 or 11.06 – to COMM.REFx, FAST COMM, COM.REFx+AI1, COM.REFx+AI5, COM.REFx*AI1 or COM.REFx*AI5. (With Generic Drive communication profile, fieldbus reference is also selected when par. 10.08 is set to 1.) The latter four selections enable correction of the fieldbus reference using analogue inputs as shown below. (An optional RAIO-01 Analogue I/O Extension Module is required for use of Analogue input AI5).

COMM.REF1 (in 11.03) or COMM.REF2 (in 11.06)

The fieldbus reference is forwarded as such without correction.

FAST COMM

The fieldbus reference is forwarded as such without correction. The reference is read every 2 milliseconds if either of the following conditions is met:

- Control location is **EXT1**, par. 99.04 MOTOR CTRL MODE is **DTC**, and par. 40.14 TRIM MODE is **OFF**
- Control location is **EXT2**, par. 99.04 MOTOR CTRL MODE is **DTC**, par. 40.14 TRIM MODE is **OFF**, and a **torque reference** is used.

In any other event, the fieldbus reference is read every 6 milliseconds.

Note: The FAST COMM selection disables the critical speed function.

COM.REF1+AI1; COM.REF1+AI5; COM.REF1*AI1; COM.REF1*AI5 (in 11.03)
 COM.REF2+AI1; COM.REF2+AI5; COM.REF2*AI1; COM.REF2*AI5 (in 11.06)
 These selections enable the correction of the fieldbus reference as follows:

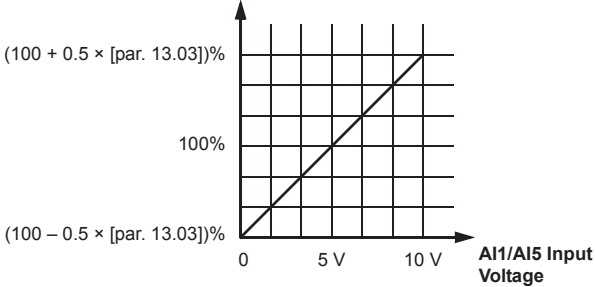
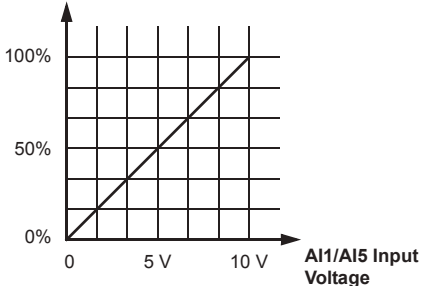
Parameter Setting	Effect of AI1/AI5 Input Voltage on Fieldbus Reference
COM.REFx+AI1 COM.REFx+AI5	<p>Fieldbus Reference Correction Coefficient</p> <p>$(100 + 0.5 \times [\text{par. } 13.03])\%$</p>  <p>100%</p> <p>$(100 - 0.5 \times [\text{par. } 13.03])\%$</p> <p>0 5 V 10 V AI1/AI5 Input Voltage</p>
COM.REFx*AI1 COM.REFx*AI5	<p>Fieldbus Reference Correction Coefficient</p>  <p>100%</p> <p>50%</p> <p>0%</p> <p>0 5 V 10 V AI1/AI5 Input Voltage</p>

Reference handling

The control of rotation direction is configured for each control location (EXT1 and EXT2) using the parameters in group 10. Fieldbus references are bipolar, i.e. they can be negative or positive. The following diagrams illustrate how group 10 parameters and the sign of the fieldbus reference interact to produce the reference REF1/REF2.

Notes:

- With the ABB Drives communication profile, 100% reference is defined by parameters [11.05](#) (REF1) and [11.08](#) (REF2).
- With the Generic Drive communication profile, 100% reference is defined by parameter [99.08](#) in DTC motor control mode (REF1), or [99.07](#) in scalar control mode (REF1), and by parameter [11.08](#) (REF2).
- External reference scaling parameters [11.04](#) and [11.07](#) are also in effect.

For information on the scaling of the fieldbus reference, see section [Fieldbus reference scaling](#) on page [214](#) (for ABB Drives profile) or [Fieldbus reference scaling](#) on page [217](#) (for Generic Drive profile).

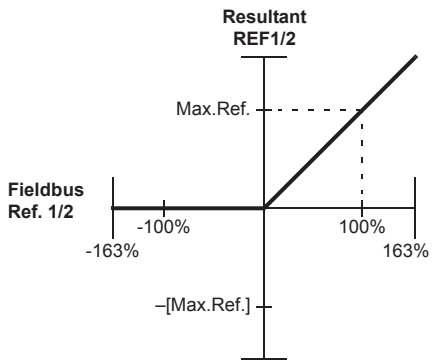
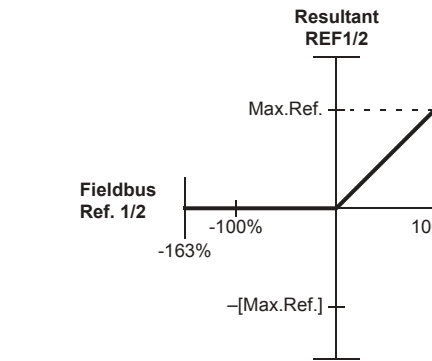
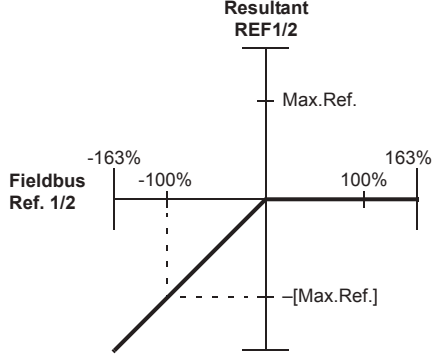
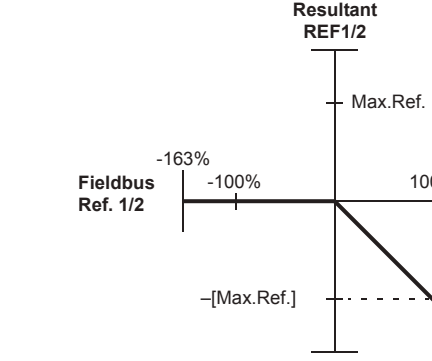
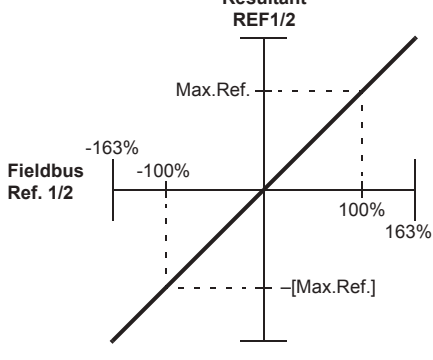
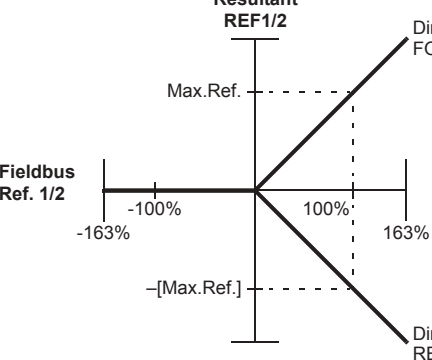
	*Direction determined by the sign of COM.REF	Direction determined by digital command, e.g. digital input, control panel
par. 10.03 DIRECTION = FORWARD		
par. 10.03 DIRECTION = REVERSE		
par. 10.03 DIRECTION = REQUEST		
<p>*Direction is determined by the sign of COM.REF when par. 10.01/10.02 EXTx STRT/STP/DIR is set to COMM.CW OR par. 11.03/11.06 EXT REFx SELECT is set to FAST COMM.</p>		

Actual Values

Actual Values (ACT) are 16-bit words containing information on selected operations of the drive. The functions to be monitored are selected with the parameters in group 92. The scaling of the integers sent to the master as Actual Values depends on the selected function; please refer to chapter *Actual signals and parameters*.

Block diagram: Control data input from fieldbus when a type Rxxx fieldbus adapter is used

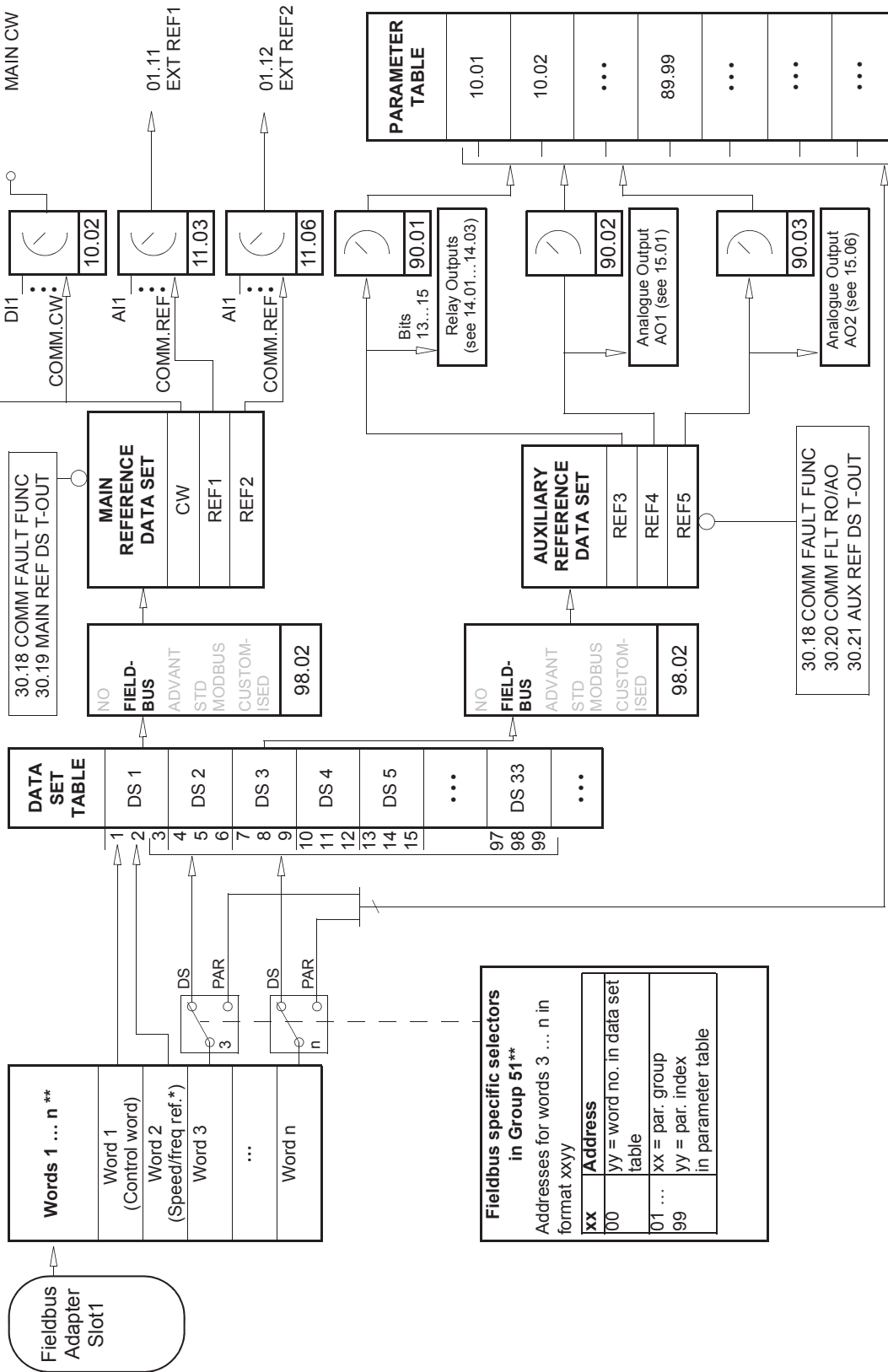

* Depends on the selected motor control mode (parameter 99.04).

** See the fieldbus adapter user's manual for more information.

Block diagram: Actual value selection for fieldbus when a type Rxxx fieldbus adapter is used

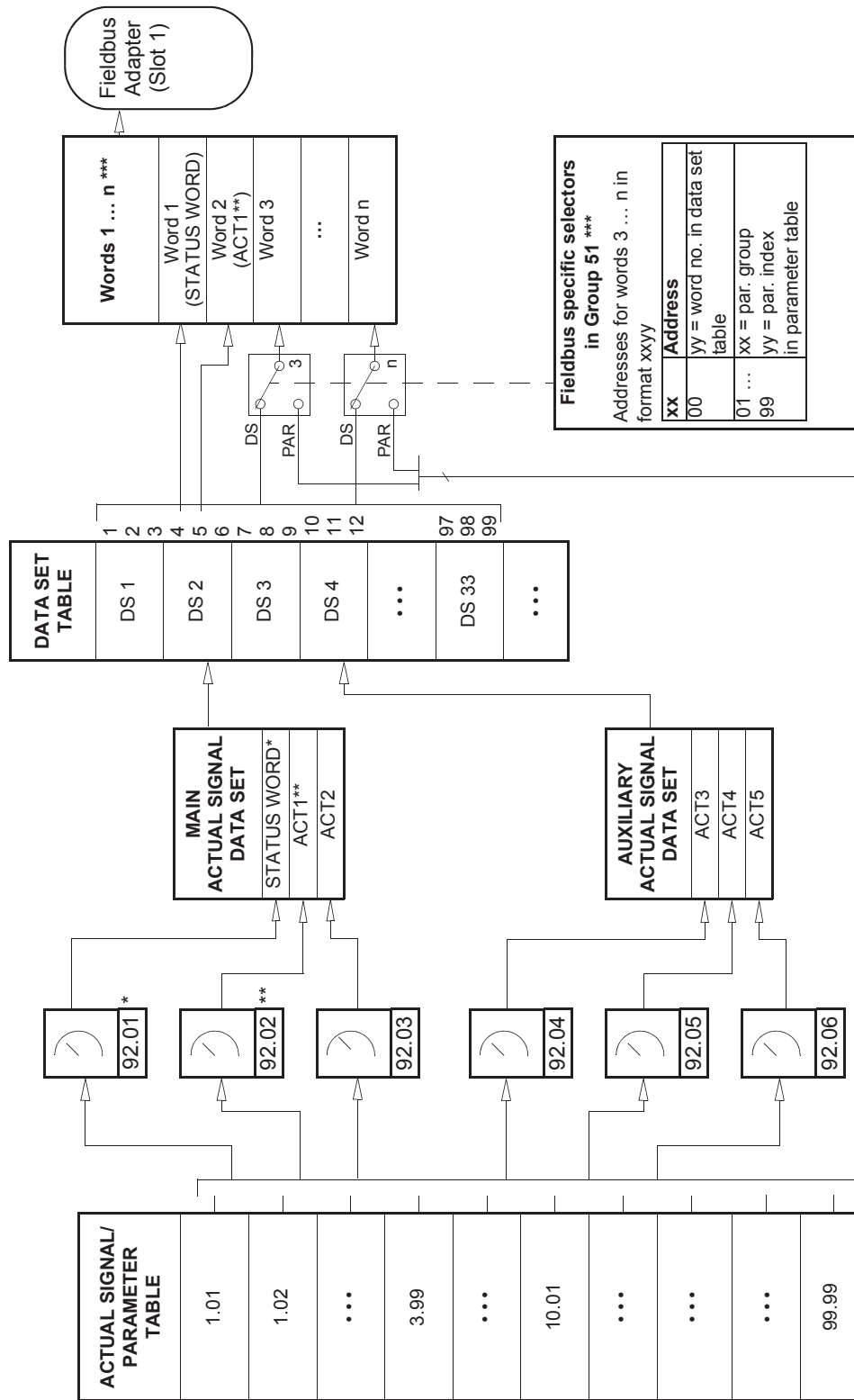

* Fixed to 03.02 MAIN STATUS WORD (bits 10, 13 and 14 are programmable).
 ** Fixed to 01.02 SPEED (DTC control) or 01.03 FREQUENCY (Scalar control) when Generic communication profile is used.
 *** See the fieldbus adapter user's manual for more information.

Block diagram: Control data input from fieldbus when a type Nxxx fieldbus adapter is used

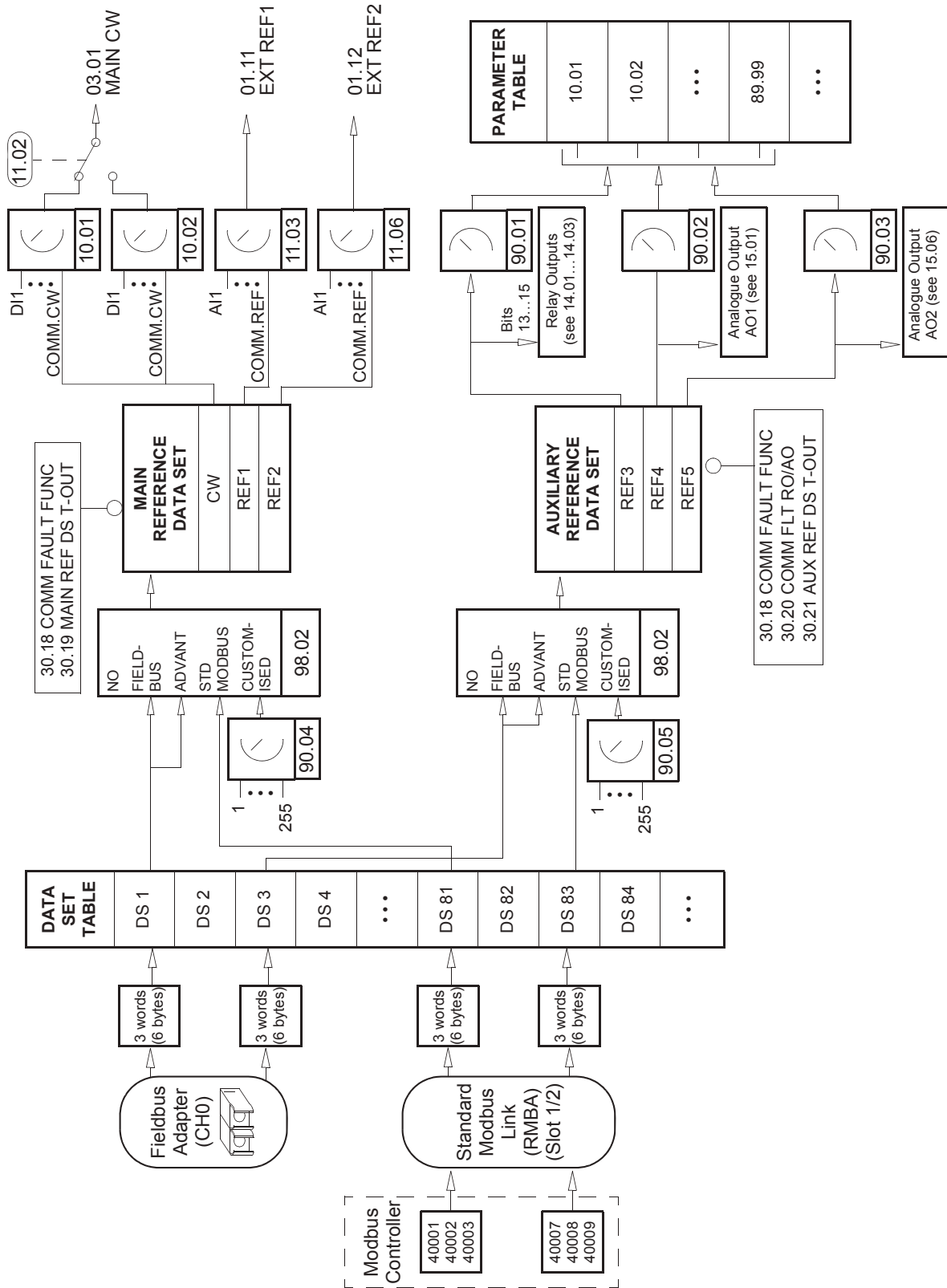

Block Diagram: Actual value selection for fieldbus when a type Nxxx fieldbus adapter is used

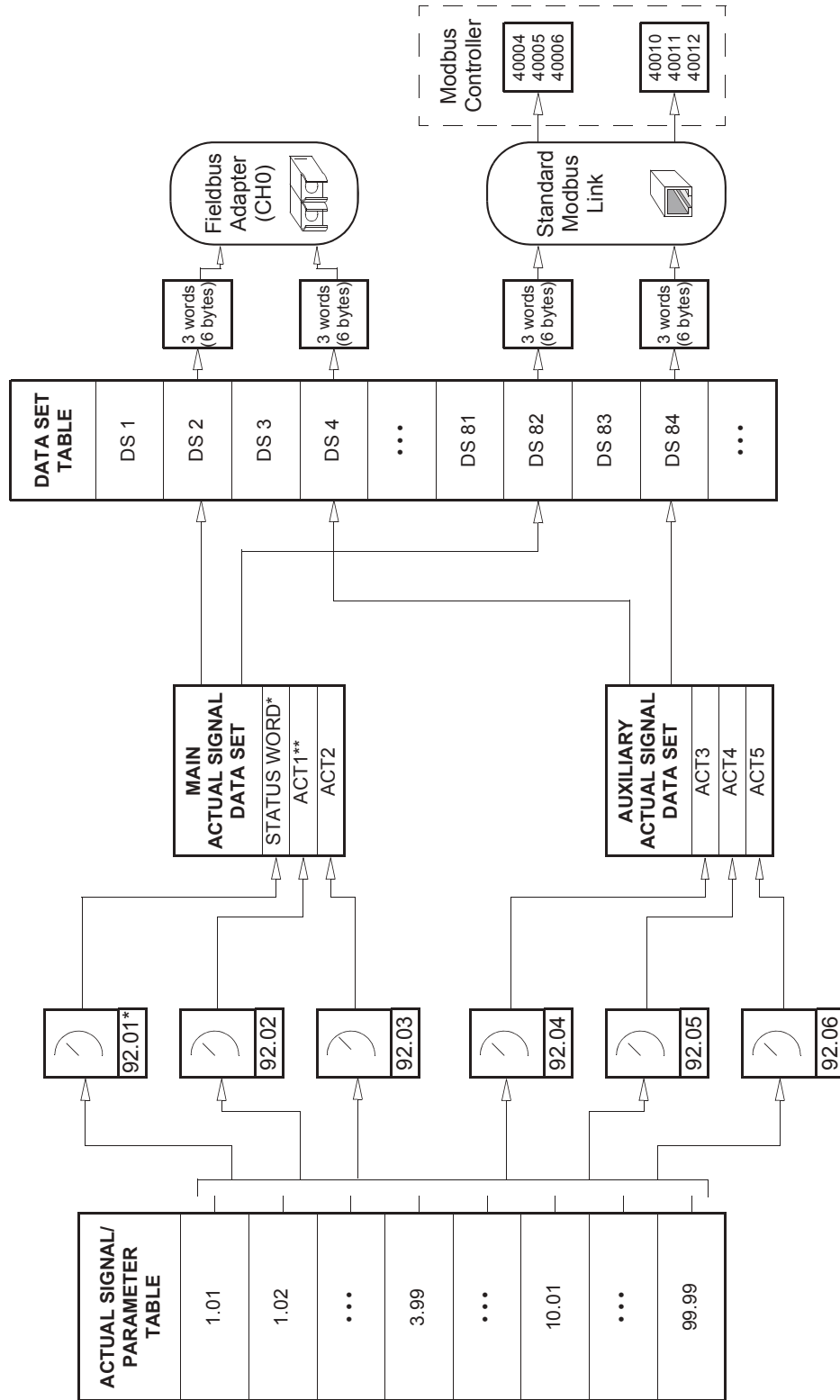

* Fixed to 03.02 MAIN STATUS WORD (bits 10, 13 and 14 are programmable).
** Fixed to 01.02 SPEED (DTC motor control) or 0103 FREQUENCY (Scalar control) when Generic communication profile is used.

Communication profiles

The ACS800 supports three communication profiles:

- ABB Drives communication profile
- Generic Drive communication profile.
- CSA 2.8/3.0 communication profile.

The ABB Drives communication profile should be selected with type Nxxx fieldbus adapter modules, and when the manufacturer-specific mode is selected (via the PLC) with type Rxxx fieldbus adapter modules.

The Generic Drive profile is supported by type Rxxx fieldbus adapter modules only.

The CSA 2.8/3.0 communication profile can be selected for backward compatibility with Application Program versions 2.8 and 3.0. This eliminates the need for reprogramming the PLC when drives with the above-mentioned program versions are replaced.

ABB Drives communication profile

The ABB Drives communication profile is active when parameter [98.07](#) is set to ABB DRIVES. The Control Word, Status Word, and reference scaling for the profile are described below.

The ABB Drives communication profile can be used through both EXT1 and EXT2. The Control Word commands are in effect when par. [10.01](#) or [10.02](#) (whichever control location is active) is set to COMM.CW.

03.01 MAIN CONTROL WORD

The upper case boldface text refers to the states shown in Figure 1.

Bit	Name	Value	Enter STATE/Description
0	OFF1 CONTROL	1	Enter READY TO OPERATE .
		0	Stop along currently active deceleration ramp (22.03/22.05). Enter OFF1 ACTIVE ; proceed to READY TO SWITCH ON unless other interlocks (OFF2, OFF3) are active.
1	OFF2 CONTROL	1	Continue operation (OFF2 inactive).
		0	Emergency OFF, coast to stop. Enter OFF2 ACTIVE ; proceed to SWITCH-ON INHIBITED .
2	OFF3 CONTROL	1	Continue operation (OFF3 inactive).
		0	Emergency stop, stop within time defined by par. 22.07. Enter OFF3 ACTIVE ; proceed to SWITCH-ON INHIBITED . Warning: Ensure motor and driven machine can be stopped using this stop mode.
3	INHIBIT_ OPERATION	1	Enter OPERATION ENABLED. (Note: The Run Enable signal must be active; see parameter 16.01. If par. 16.01 is set to COMM.CW, this bit also activates the Run Enable signal.)
		0	Inhibit operation. Enter OPERATION INHIBITED .
4	RAMP_OUT_ ZERO	1	Normal operation. Enter RAMP FUNCTION GENERATOR: OUTPUT ENABLED .
		0	Force Ramp Function Generator output to zero. Drive ramps to stop (current and DC voltage limits in force).
5	RAMP_HOLD	1	Enable ramp function. Enter RAMP FUNCTION GENERATOR: ACCELERATOR ENABLED .
		0	Halt ramping (Ramp Function Generator output held).
6	RAMP_IN_ ZERO	1	Normal operation. Enter OPERATING .
		0	Force Ramp Function Generator input to zero.
7	RESET	0 ⇒ 1	Fault reset if an active fault exists. Enter SWITCH-ON INHIBITED .
		0	Continue normal operation.
8	INCHING_1	1	Not in use.
		1 ⇒ 0	Not in use.
9	INCHING_2	1	Not in use.
		1 ⇒ 0	Not in use.
10	REMOTE_CMD	1	Fieldbus control enabled.
		0	Control Word <> 0 or Reference <> 0: Retain last Control Word and Reference. Control Word = 0 and Reference = 0: Fieldbus control enabled. Reference and deceleration/acceleration ramp are locked.
11	EXT CTRL LOC	1	Select External Control Location EXT2. Effective if par. 11.02 is set to COMM.CW.
		0	Select External Control Location EXT1. Effective if par. 11.02 is set to COMM.CW.
12 ... 15	Reserved		

03.02 MAIN STATUS WORD

The upper case boldface text refers to the states shown in [Figure 1](#).

Bit	Name	Value	STATE/Description
0	RDY_ON	1	READY TO SWITCH ON.
		0	NOT READY TO SWITCH ON.
1	RDY_RUN	1	READY TO OPERATE.
		0	OFF1 ACTIVE.
2	RDY_REF	1	OPERATION ENABLED.
		0	OPERATION INHIBITED.
3	TRIPPED	1	FAULT.
		0	No fault.
4	OFF_2_STA	1	OFF2 inactive.
		0	OFF2 ACTIVE.
5	OFF_3_STA	1	OFF3 inactive.
		0	OFF3 ACTIVE.
6	SWC_ON_INHIB	1	SWITCH-ON INHIBITED.
		0	
7	ALARM	1	Warning/Alarm.
		0	No Warning/Alarm.
8	AT_SETPOINT	1	OPERATING. Actual value equals reference value (= is within tolerance limits i.e in speed control the speed error is less than or equal to 10% of the nominal motor speed).
		0	Actual value differs from reference value (= is outside tolerance limits).
9	REMOTE	1	Drive control location: REMOTE (EXT1 or EXT2).
		0	Drive control location: LOCAL.
10	ABOVE_LIMIT	1	Bit is read from the address defined by parameter 92.07 MSW B10 PTR. The default value is signal 03.14 bit 9 ABOVE_LIMIT: Actual frequency or speed value equals or exceeds the supervision limit (par. 32.02).
		0	Actual frequency or speed value is within supervision limit.
11	EXT CTRL LOC	1	External Control Location EXT2 selected.
		0	External Control Location EXT1 selected.
12	EXT RUN ENABLE	1	External Run Enable signal received.
		0	No External Run Enable received.
13			Bit is read from the address defined by parameter 92.08 MSW B13 PTR. By default no address has been selected.
14			Bit is read from the address defined by parameter 92.09 MSW B14 PTR. By default no address has been selected.
15		1	Communication error detected by fieldbus adapter module (on fibre optic channel CH0).
		0	Fieldbus adapter (CH0) communication OK.

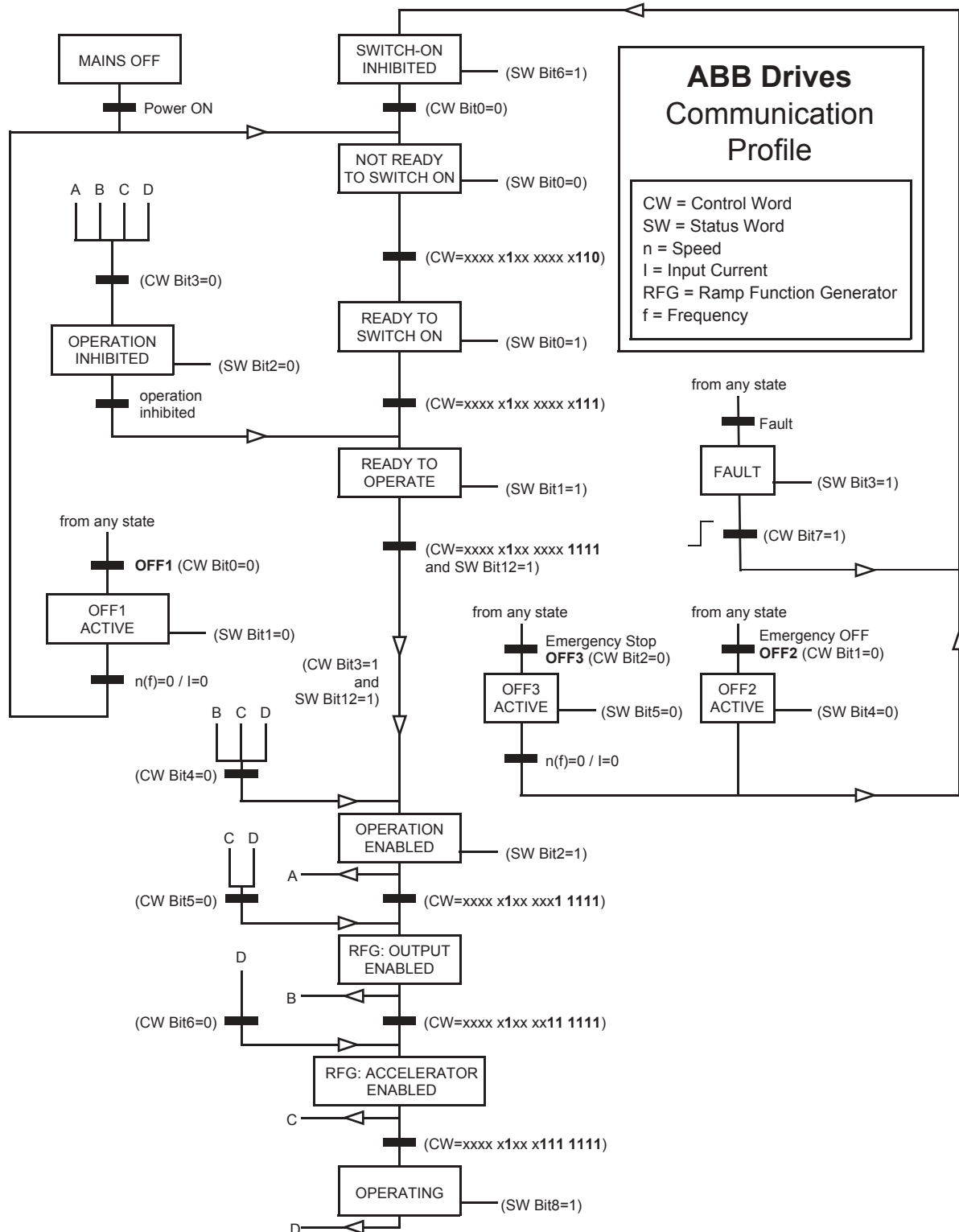

Figure 1 State Machine for the ABB Drives communication profile.

Fieldbus reference scaling

With the ABB Drives communication profile active, fieldbus references REF1 and REF2 are scaled as shown in the table below.

Note: Any correction of the reference is applied before scaling. See section [References](#) on page 203.

Ref. No.	Application Macro used (par. 99.02)	Range	Reference type	Scaling	Notes
REF1	(any)	-32768 ... 32767	Speed or Frequency (not with FAST COMM)	-20000 = -[par. 11.05] -1 = -[par. 11.04] 0 = [par. 11.04] 20000 = [par. 11.05]	Final reference limited by 20.01/20.02 [speed] or 20.07/20.08 [frequency].
			Speed or Frequency with FAST COMM	-20000 = -[par. 11.05] 0 = 0 20000 = [par. 11.05]	Final reference limited by 20.01/20.02 [speed] or 20.07/20.08 [frequency].
REF2	FACTORY, HAND/AUTO, or SEQ CTRL	-32768 ... 32767	Speed or Freq. (not with FAST COMM)	-20000 = -[par. 11.08] -1 = -[par. 11.07] 0 = [par. 11.07] 20000 = [par. 11.08]	Final reference limited by 20.01/20.02 [speed] or 20.07/20.08 [frequency].
			Speed or Freq. with FAST COMM	-20000 = -[par. 11.08] 0 = 0 20000 = [par. 11.08]	Final reference limited by 20.01/20.02 [speed] or 20.07/20.08 [frequency].
	T CTRL or M/F (optional)	-32768 ... 32767	Torque (not with FAST COMM)	-10000 = -[par. 11.08] -1 = -[par. 11.07] 0 = [par. 11.07] 10000 = [par. 11.08]	Final reference limited by par. 20.04.
			Torque with FAST COMM	-10000 = -[par. 11.08] 0 = 0 10000 = [par. 11.08]	Final reference limited by par. 20.04.
	PID CTRL	-32768 ... 32767	PID Reference (not with FAST COMM)	-10000 = -[par. 11.08] -1 = -[par. 11.07] 0 = [par. 11.07] 10000 = [par. 11.08]	
			PID Reference with FAST COMM	-10000 = -[par. 11.08] 0 = 0 10000 = [par. 11.08]	

Generic Drive communication profile

The Generic Drive communication profile is active when parameter 98.07 is set to GENERIC. The Generic Drive profile realises the device profile for drives – speed control only – as defined by specific fieldbus standards such as PROFIDRIVE for PROFIBUS, AC/DC Drive for DeviceNet™, Drives and Motion Control for CANopen®, etc. Each device profile specifies its Control and Status Words, Reference and Actual value scaling. The profiles also define Mandatory services which are transferred to the application interface of the drive in a standardised way.

The Generic Drive communication profile can be used through both EXT1 and EXT2*. The proper functioning of the Generic Drive profile requires that Control Word commands are enabled by setting parameter 10.01 or 10.02 (whichever control location is active) to COMM.CW (or par. 10.07 to 1) and by setting parameter 16.01 to YES.

*For vendor specific support of EXT2 reference, see appropriate fieldbus manual.

Note: The Generic Drive profile is only available with type Rxxx fieldbus adapter modules.

Drive commands supported by the Generic Drive communication profile

Name	Description
STOP	The drive decelerates the motor to zero speed according to the active deceleration ramp (parameter 22.03 or 22.05).
START	The drive accelerates to the set reference value according to the active acceleration ramp (par. 22.02 or 22.04). The direction of rotation is determined by the sign of the reference value and the setting of par. 10.03.
COAST STOP	The drive coasts to stop, i.e. the drive stops modulating. However, this command can be overridden by the Brake Control function, which forces the drive to decelerate to zero speed by the active deceleration ramp. When the Brake Control function is active, Coast stop and Emergency coast stop (OFF2) commands given after the Emergency ramp stop (OFF3) coast the drive to a stop.
QUICK STOP	The drive decelerates the motor to zero speed within the emergency stop deceleration time defined by par. 22.07.
CURRENT LIMIT STOP (CLS)	The drive decelerates the motor to zero speed according to the set current limit (par. 20.03) or torque limit (20.04), whichever is first reached. The same procedure is valid in case of a Voltage Limit Stop (VLS).
INCHING1	With this command active, the drive accelerates the motor to Constant Speed 12 (defined by par. 12.13). After the command is removed, the drive decelerates the motor to zero speed. Note: The speed reference ramps are not effective. The speed change rate is only limited by the current (or torque) limit of the drive. Note: Inching 1 takes priority over Inching 2. Note: Not effective in Scalar control mode.
INCHING2	With this command active, the drive accelerates the motor to Constant Speed 13 (defined by par. 12.14). After the command is removed, the drive decelerates the motor to zero speed. Note: The speed reference ramps are not effective. The speed change rate is only limited by the current (or torque) limit of the drive. Note: Inching 1 takes priority over Inching 2. Note: Not effective in Scalar control mode.
RAMP OUT ZERO	When active, forces the output of the reference function generator to zero.
RAMP HOLD	When active, freezes the reference function generator output.
FORCED TRIP	Trips the drive. The drive will indicate fault FORCED TRIP.
RESET	Resets an active fault.

Fieldbus reference scaling

With the Generic Drive communication profile active, the speed reference value received from the fieldbus and the actual speed value received from the drive are scaled as shown in the table below.

Note: Any correction of the reference (see section [References](#) on page 203) is applied before scaling.

Ref. No.	Application Macro used (par. 99.02)	Range	Reference type	Speed reference scaling	Actual speed scaling*	Notes
REF1	(any)	-32768... 32767	Speed or Frequency	0 = 0 20000 = [par. 99.08 (DTC) / 99.07 (scalar)]**	0 = 0 20000 = [par. 99.08 (DTC) / 99.07 (scalar)]**	
REF2	FACTORY, HAND/AUT or SEQ CTRL	-32768... 32767	Speed or Freq. (not with FAST COMM)	-20000 = -[par. 11.08] -1 = -[par. 11.07] 0 = [par. 11.07] 20000 = [par. 11.08]	0 = 0 20000 = [par. 99.08 (DTC) / 99.07 (scalar)]**	Final reference limited by 20.01/20.02 [speed] or 20.07/20.08 [frequency]
			Speed or Freq. with FAST COMM	-20000 = -[par. 11.08] 0 = 0 20000 = [par. 11.08]	0 = 0 20000 = [par. 99.08 (DTC) / 99.07 (scalar)]**	Final reference limited by 20.01/20.02 [speed] or 20.07/20.08 [frequency]
	T CTRL or M/F (optional)	-32768... 32767	Torque (not with FAST COMM)	-10000 = -[par. 11.08] -1 = -[par. 11.07] 0 = [par. 11.07] 10000 = [par. 11.08]	0 = 0 20000 = [par. 99.08 (DTC) / 99.07 (scalar)]**	Final reference limited by par. 20.04
			Torque with FAST COMM	-10000 = -[par. 11.08] 0 = 0 10000 = [par. 11.08]	0 = 0 20000 = [par. 99.08 (DTC) / 99.07 (scalar)]**	Final reference limited by par. 20.04
PID CTRL	-32768... 32767	PID Reference (not with FAST COMM)	-10000 = -[par. 11.08] -1 = -[par. 11.07] 0 = [par. 11.07] 10000 = [par. 11.08]	0 = 0 20000 = [par. 99.08 (DTC) / 99.07 (scalar)]**		
		PID Reference with FAST COMM	-10000 = -[par. 11.08] 0 = 0 10000 = [par. 11.08]	0 = 0 20000 = [par. 99.08 (DTC) / 99.07 (scalar)]**		

* With DTC the filter time of the actual speed value can be adjusted using parameter 34.04.

** **Note:** The maximum reference value is 163% (i.e. 163% = 1.63 · value of parameter 99.08/99.07 value).

CSA 2.8/3.0 communication profile

The CSA 2.8/3.0 communication profile is active when parameter 98.07 is set to CSA 2.8/3.0. The Control Word and Status Word for the profile are described below.

CONTROL WORD for the CSA 2.8/3.0 communication profile

Bit	Name	Value	Description
0	Reserved		
1	ENABLE	1	Enabled.
		0	Coast to stop.
2	Reserved		
3	START/STOP	0 ⇒ 1	Start.
		0	Stop according to parameter 21.03 STOP FUNCTION.
4	Reserved		
5	CNTRL_MODE	1	Select control mode 2.
		0	Select control mode 1.
6	Reserved		
7	Reserved		
8	RESET_FAULT	0 ⇒ 1	Reset drive fault.
9 ... 15	Reserved		

STATUS WORD for the CSA 2.8/3.0 communication profile

Bit	Name	Value	Description
0	READY	1	Ready to start.
		0	Initialising, or initialising error.
1	ENABLE	1	Enabled.
		0	Coast to stop.
2	Reserved		
3	RUNNING	1	Running with selected reference.
		0	Stopped.
4	Reserved		
5	REMOTE	1	Drive in Remote mode
		0	Drive in Local mode
6	Reserved		
7	AT_SETPOINT	1	Drive at reference
		0	Drive not at reference
8	FAULTED	1	A fault is active.
		0	No active faults
9	WARNING	1	A warning is active.
		0	No active warnings
10	LIMIT	1	Drive at a limit
		0	Drive at no limit
11 ... 15	Reserved		

The reference and actual scaling is equal to that of the ABB Drives profile.

Diverse status, fault, alarm and limit words

03.03 AUXILIARY STATUS WORD

Bit	Name	Description
0	Reserved	
1	OUT OF WINDOW	Speed difference is out of the window (in speed control)*.
2	Reserved	
3	MAGNETIZED	Flux has been formed in the motor.
4	Reserved	
5	SYNC RDY	Position counter synchronised.
6	1 START NOT DONE	Drive has not been started after changing the motor parameters in group 99.
7	IDENTIF RUN DONE	Motor ID Run successfully completed.
8	START INHIBITION	Safe torque off function or Prevention of unexpected start-up is active.
9	LIMITING	Control at a limit. See actual signal 3.04 LIMIT WORD 1 below.
10	TORQ CONTROL	Torque reference is followed*.
11	ZERO SPEED	Absolute value of motor actual speed is below zero speed limit (4% of synchronous speed).
12	INTERNAL SPEED FB	Internal speed feedback followed.
13	M/F COMM ERR	Master/Follower link (on CH2) communication error*.
14 ... 15	Reserved	

*See the *Master/Follower Application Guide* [3AFY58962180 (English)].

03.04 LIMIT WORD 1

Bit	Name	Active Limit
0	TORQ MOTOR LIM	Pull-out limit
1	SPD_TOR_MIN_LIM	Speed control torque min. limit
2	SPD_TOR_MAX_LIM	Speed control torque max. limit
3	TORQ_USER_CUR_LIM	User-defined current limit
4	TORQ_INV_CUR_LIM	Internal current limit
5	TORQ_MIN_LIM	Any torque min. limit
6	TORQ_MAX_LIM	Any torque max. limit
7	TREF_TORQ_MIN_LIM	Torque reference min. limit
8	TREF_TORQ_MAX_LIM	Torque reference max. limit
9	FLUX_MIN_LIM	Flux reference min. limit
10	FREQ_MIN_LIMIT	Speed/Frequency min. limit
11	FREQ_MAX_LIMIT	Speed/Frequency max. limit
12	DC_UNDERVOLT	DC undervoltage limit
13	DC_OVERVOLT	DC overvoltage limit
14	TORQUE LIMIT	Any torque limit
15	FREQ_LIMIT	Any speed/frequency limit

03.05 FAULT WORD 1

Bit	Name	Description
0	SHORT CIRC	For the possible causes and remedies, see chapter <i>Fault tracing</i> .
1	OVERCURRENT	
2	DC OVERVOLT	
3	ACS800 TEMP	
4	EARTH FAULT	
5	THERMISTOR	
6	MOTOR TEMP	
7	SYSTEM_FAULT	A fault is indicated by the System Fault Word (Actual Signal 3.07).
8	UNDERLOAD	For the possible causes and remedies, see chapter <i>Fault tracing</i> .
9	OVERFREQ	
10 ... 15	Reserved	

03.06 FAULT WORD 2

Bit	Name	Description
0	SUPPLY PHASE	For the possible causes and remedies, see chapter <i>Fault tracing</i> .
1	NO MOT DATA	
2	DC UNDERVOLT	
3	Reserved	
4	RUN ENABLE	For the possible causes and remedies, see chapter <i>Fault tracing</i> .
5	ENCODER ERR	
6	I/O COMM	
7	CTRL B TEMP	
8	EXTERNAL FLT	
9	OVER SWFREQ	
10	AI < MIN FUNC	
11	PPCC LINK	
12	COMM MODULE	
13	PANEL LOSS	
14	MOTOR STALL	
15	MOTOR PHASE	

03.07 SYSTEM FAULT WORD

Bit	Name	Description
0	FLT (F1_7)	Factory default parameter file error
1	USER MACRO	User Macro file error
2	FLT (F1_4)	FEPROM operating error
3	FLT (F1_5)	FEPROM data error
4	FLT (F2_12)	Internal time level 2 overflow
5	FLT (F2_13)	Internal time level 3 overflow
6	FLT (F2_14)	Internal time level 4 overflow
7	FLT (F2_15)	Internal time level 5 overflow
8	FLT (F2_16)	State machine overflow
9	FLT (F2_17)	Application program execution error
10	FLT (F2_18)	Application program execution error
11	FLT (F2_19)	Illegal instruction
12	FLT (F2_3)	Register stack overflow
13	FLT (F2_1)	System stack overflow
14	FLT (F2_0)	System stack underflow
15	Reserved	

03.08 ALARM WORD 1

Bit	Name	Description
0	START INHIBIT	For the possible causes and remedies, see chapter Fault tracing .
1	Reserved	
2	THERMISTOR	For the possible causes and remedies, see chapter Fault tracing .
3	MOTOR TEMP	
4	ACS800 TEMP	
5	ENCODER ERR	
6	T MEAS ALM	
7 ... 11	Reserved	
12	COMM MODULE	For the possible causes and remedies, see chapter Fault tracing .
13	Reserved	
14	EARTH FAULT	For the possible causes and remedies, see chapter Fault tracing .
15	Reserved	

03.09 ALARM WORD 2

Bit	Name	Description
0	Reserved	
1	UNDERLOAD	For the possible causes and remedies, see chapter Fault tracing .
2, 3	Reserved	
4	ENCODER	For the possible causes and remedies, see chapter Fault tracing .
5, 6	Reserved	
7	POWFAIL FILE (FFA0)	Error in restoring POWERFAIL.DDF
8	ALM (OS_17)	Error in restoring POWERDOWN.DDF
9	MOTOR STALL	For the possible causes and remedies, see chapter Fault tracing .
10	AI < MIN FUNC	
11, 12	Reserved	
13	PANEL LOSS	For the possible causes and remedies, see chapter Fault tracing .
14, 15	Reserved	

03.13 AUXILIARY STATUS WORD 3

Bit	Name	Description
0	REVERSED	Motor rotates in reverse direction.
1	EXT CTRL	External control is selected.
2	REF 2 SEL	Reference 2 is selected.
3	CONST SPEED	A Constant Speed (1...15) is selected.
4	STARTED	The drive has received a Start command.
5	USER 2 SEL	User Macro 2 has been loaded.
6	OPEN BRAKE	The Open Brake command is ON. See group 42 BRAKE CONTROL .
7	LOSS OF REF	The reference has been lost.
8	STOP DI STATUS	The state of the interlock input on the RMIO board.
9	READY	Ready to function: Run enable signal on, no fault
10	DATASET STATUS	Data set has not been updated.
11	MACRO CHG	Macro is changing or is being saved.
12...15	Reserved	

03.14 AUXILIARY STATUS WORD 4

Bit	Name	Description
0	SPEED 1 LIM	Output speed has exceeded or fallen below supervision limit 1. See group 32 SUPERVISION .
1	SPEED 2 LIM	Output speed has exceeded or fallen below supervision limit 2. See group 32 SUPERVISION .
2	CURRENT LIM	Motor current has exceeded or fallen below the set supervision limit. See group 32 SUPERVISION .
3	REF 1 LIM	Reference 1 has exceeded or fallen below the set supervision limit. See group 32 SUPERVISION .
4	REF 2 LIM	Reference 2 has exceeded or fallen below the set supervision limit. See group 32 SUPERVISION .
5	TORQUE 1 LIM	The motor torque has exceeded or fallen below the TORQUE1 supervision limit. See group 32 SUPERVISION .
6	TORQUE 2 LIM	The motor torque has exceeded or fallen below the TORQUE2 supervision limit. See group 32 SUPERVISION .
7	ACT 1 LIM	PID controller actual value 1 has exceeded or fallen below the set supervision limit. See group 32 SUPERVISION .
8	ACT 2 LIM	PID controller actual value 2 has exceeded or fallen below the set supervision limit. See group 32 SUPERVISION .
9	ABOVE_LIMIT	1 = Actual frequency or speed value equals or exceeds the supervision limit (par. 32.02). 0 = Actual frequency or speed value is within supervision limit.
10 ... 15	Reserved	

03.15 FAULT WORD 4

Bit	Name	Description
0	CHOKE OTEMP	Step-up module fault
1	MOTOR 1 TEMP	For the possible causes and remedies, see chapter Fault tracing .
2	MOTOR 2 TEMP	
3	BRAKE ACKN	
4 ... 15	Reserved	

03.16 ALARM WORD 4

Bit	Name	Description
0	FAN OTEMP	Step-up module fan overtemperature alarm
1	MOTOR 1 TEMP	For the possible causes and remedies, see chapter Fault tracing .
2	MOTOR 2 TEMP	
3	BRAKE ACKN	
4	SLEEP MODE	
5	MACRO CHANGING	User or Application macro is being saved or loaded
6 ... 15	Reserved	

03.17 FAULT WORD 5

Bit	Name	Description
0	BR BROKEN	For the possible causes and remedies, see chapter Fault tracing .
1	BR WIRING	
2	BC SHORT CIR	
3	BR OVERHEAT	
4	BC OVERHEAT	
5	IN CHOKE TEMP	
6	PP OVERLOAD	
7	INV DISABLED	
8	TEMP DIF	
9	POWERF INV xx/ POWERFAIL	
10	INT CONFIG	
11	USER L CURVE	
12	Reserved	
13	INV OVERTEMP	For the possible causes and remedies, see chapter Fault tracing .
14...15	Reserved	

03.18 ALARM WORD 5

Bit	Name	Description
0	REPLACE FAN	For the possible causes and remedies, see chapter <i>Fault tracing</i> .
1	SYNCRO SPEED	
2	BR OVERHEAT	
3	BC OVERHEAT	
4	IN CHOKE TEMP	
5	PP OVERLOAD	
6	INV DISABLED	
7	CUR UNBAL	
8	INV CUR LIM	
9	DC BUS LIM	
10	MOT CUR LIM	
11	MOT TORQ LIM	
12	MOT POW LIM	
13	USER L CURVE	
14	Reserved	
15	BATT FAILURE	For the possible causes and remedies, see chapter <i>Fault tracing</i> .

03.19 INT INIT FAULT

Bit	Name	Description
0	AINT FAULT	Wrong EPLD version
1	AINT FAULT	Wrong AINT board revision
2	AINT FAULT	Du/dt limitation hardware failure
3	AINT FAULT	Current measurement scaling error
4	AINT FAULT	Voltage measurement scaling error
5 ... 15	Reserved	
This signal is active with AINT board.		

03.30 LIMIT WORD INV

The LIMIT WORD INV Word includes faults and warnings, which occur when the output current limit of the drive is exceeded. The current limit protects the drive in various cases, e.g. integrator overload, high IGBT temperature etc.

Bit	Name	Description
0	INTEGRAT 200	Current limit at 200% integrator overload. Temperature model is not active.*
1	INTEGRAT 150	Current limit at 150% integrator overload. Temperature model is not active.*
2	INT LOW FREQ	Current limit at high IGBT temperature with low output frequency (<10 Hz). Temperature model is not active.*
3	INTG PP TEMP	Current limit at high IGBT temperature. Temperature model is not active.*
4	PP OVER TEMP	Current limit at high IGBT temperature. Temperature model is active.
5	PP OVERLOAD	Current limit at high IGBT junction to case temperature. Temperature model is active. If the IGBT junction to case temperature continues to rise in spite of the current limitation, PP OVERLOAD alarm or fault occurs. See chapter Fault tracing
6	INV POW LIM	Current limit at inverter output power limit
7	INV TRIP CUR	Current limit at inverter overcurrent trip limit
8	OVERLOAD CUR	Maximum inverter overload current limit. See par. 20.03 .
9	CONT DC CUR	Continuous dc-current limit
10	CONT OUT CUR	Continuous output current limit ($I_{cont.max}$)
11...15	Reserved	

*Not active with ACS800 Factory macro default settings.

03.31 ALARM WORD 6

Bit	Name	Description
0	INV OVERTEMP	For the possible causes and remedies, see chapter Fault tracing .
1...2	Reserved	
3	ENC CABLE	For the possible causes and remedies, see chapter Fault tracing .
4...15	Reserved	

03.32 EXT IO STATUS

Bit	Name	Description
0	EMSTOP MODULE ERROR	Emergency stop module is not communicating with the drive software.
1	EMSTOP OFF2 CMD	DI1 of emergency stop module. See 03.01 MAIN CONTROL WORD bit1 OFF2 CONTROL.
2	EMSTOP OFF3 CMD	DI2 of emergency stop module. See 03.01 MAIN CONTROL WORD bit2 OFF3 CONTROL.
3	FREE	DI3 of emergency stop module.
4	EMSTOP OFF3 STATUS	RO1 of emergency stop module. See 03.02 MAIN STATUS WORD bit5 OFF_3_STA. Bit inverted.
5	EMSTOP TRIP STATUS	RO2 of emergency stop module. See 03.02 MAIN STATUS WORD bit3 TRIPPED.
6	STEPUP MODULE ERROR	Step up module is not communicating with the drive software.
7	STEPUP CHOKE FLT CMD	DI1 of Step-Up module. For the possible causes and remedies, see chapter Fault tracing: CHOKE OTEMP (FF82) .
8	STEPUP FAN ALM CMD	DI2 of Step-Up module. For possible causes and remedies, see chapter Fault tracing: FAN OTEMP (FF83) .
9	FREE	DI3 of Step-Up module.
10	STEPUP MODULATING STATUS	RO1 of Step-Up module. Drive is modulating.
11	STEPUP TRIP STATUS	RO2 of Step-Up module. See 03.02 MAIN STATUS WORD bit3 TRIPPED.
12-15	Reserved	

03.33 FAULT WORD 6

Bit	Name	Description
0...1	Reserved	
2	ENC CABLE	For possible causes and remedies, see chapter Fault tracing .
3...15	Reserved	

04.01 FAULTED INT INFO

The FAULTED INT INFO Word includes information on the location of faults PPCC LINK, OVERCURRENT, EARTH FAULT, SHORT CIRCUIT, ACS800 TEMP, TEMP DIF and POWERF INV (see [03.05 FAULT WORD 1](#), [03.06 FAULT WORD 2](#), [03.17 FAULT WORD 5](#) and chapter *Fault tracing*).

Bit	Name	Description
0	INT 1 FLT	INT 1 board fault
1	INT 2 FLT	INT 2 board fault
2	INT 3 FLT	INT 3 board fault
3	INT 4 FLT	INT 4 board fault
4	INT 5 FLT	INT 5 board fault
5	INT 6 FLT	INT 6 board fault
6	INT 7 FLT	INT 7 board fault
7	INT 8 FLT	INT 8 board fault
8	INT 9 FLT	INT 9 board fault
9	INT 10 FLT	INT 10 board fault
10	INT 11 FLT	INT 11 board fault
11	INT 12 FLT	INT 12 board fault
12...14	Reserved	
15	PBU FLT	PBU board fault

Used only with parallel connected inverters.

Inverter Block Diagram

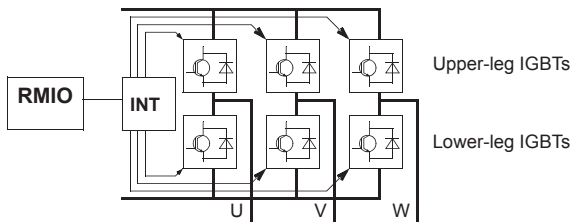

RMIO	Motor Control and I/O Board
INT	Main Circuit Interface Board
PBU	PPCS Link Branching Unit

Inverter Unit Block Diagram (2 to 12 parallel inverters)

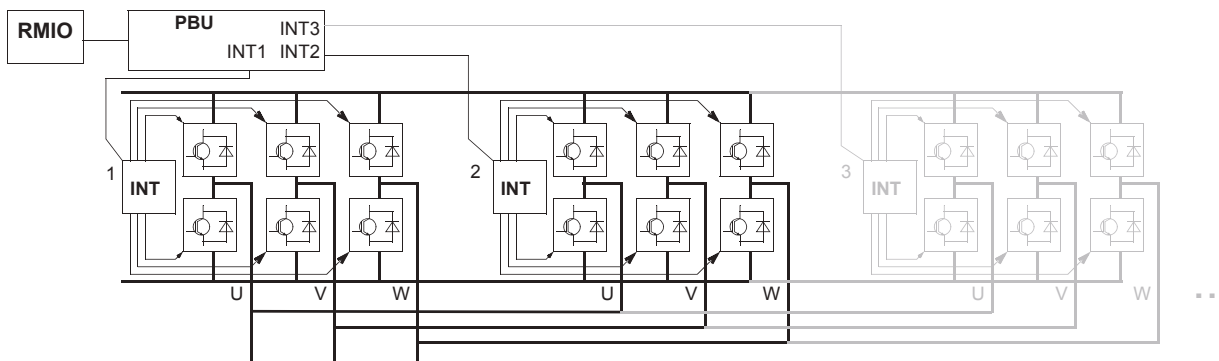

04.02 INT SC INFO

The INT SC INFO Word includes information on the location of the SHORT CIRCUIT fault (see [03.05 FAULT WORD 1](#) and chapter *Fault tracing*).

Bit	Name	Description
0	U-PH SC U	Phase U upper-leg IGBT(s) short circuit
1	U-PH SC L	Phase U lower-leg IGBT(s) short circuit
2	V-PH SC U	Phase V upper-leg IGBT(s) short circuit
3	V-PH SC L	Phase V lower-leg IGBT(s) short circuit
4	W-PH SC U	Phase W upper-leg IGBT(s) short circuit
5	W-PH SC L	Phase W lower-leg IGBT(s) short circuit
6...15	Reserved	

Fault tracing

Chapter overview

The chapter lists all warning and fault messages including the possible cause and corrective actions.

Safety



WARNING! Only qualified electricians are allowed to maintain the drive. The *Safety Instructions* on the first pages of the appropriate hardware manual must be read before you start working with the drive.

Warning and fault indications

A warning or fault message on the panel display indicates abnormal drive status. Most warning and fault causes can be identified and corrected using this information. If not, an ABB representative should be contacted.

If the drive is operated with the control panel detached, the red LED in the panel mounting platform indicates the fault condition. (Note: Some drive types are not fitted with the LEDs as standard).

The four digit code number in brackets after the message is for the fieldbus communication. (See chapter [Fieldbus control](#).)

How to reset

The drive can be reset either by pressing the keypad **RESET** key, by digital input or fieldbus, or switching the supply voltage off for a while. When the fault has been removed, the motor can be restarted.

Fault history

When a fault is detected, it is stored in the Fault History. The latest faults and warnings are stored together with the time stamp at which the event was detected.

The fault logger collects 64 of the latest faults. When the drive power is switched off, 16 of the latest faults are stored.

See chapter [Control panel](#) for more information.

Warning messages generated by the drive

WARNING	CAUSE	WHAT TO DO
ACS800 TEMP (4210) 3.08 AW 1 bit 4	Drive IGBT temperature is excessive. Fault trip limit is 100%.	Check ambient conditions. Check air flow and fan operation. Check heatsink fins for dust pick-up. Check motor power against unit power.
AI < MIN FUNC (8110) 3.09 AW 2 bit 10 (programmable Fault Function 30.01)	Analogue control signal is below minimum allowed value due to incorrect signal level or failure in control wiring.	Check for proper analogue control signal levels. Check control wiring. Check Fault Function parameters.
AD [message]	Message generated by an EVENT block in the Adaptive Program.	Consult the documentation or author of the Adaptive Program.
BACKUP USED (FFA3)	PC stored backup of drive parameters is downloaded into use.	Wait until download is completed.
BATT FAILURE (5581) 3.18 AW 5 bit 15	APBU branching unit memory backup battery error caused by - incorrect APBU switch S3 setting - too low battery voltage.	With parallel connected inverters, enable backup battery by setting actuator 6 of switch S3 to ON. Replace backup battery.
BC OVERHEAT (7114) 3.18 AW 5 bit 3	Brake chopper overload	Stop drive. Let chopper cool down. Check parameter settings of resistor overload protection function (see parameter group 27 BRAKE CHOPPER). Check that braking cycle meets allowed limits. Check that drive supply AC voltage is not excessive.
BRAKE ACKN (FF74) 3.16 AW 4 bit 3	Unexpected state of brake acknowledge signal	See parameter group 42 BRAKE CONTROL . Check connection of brake acknowledgement signal.
BR OVERHEAT (7112) 3.18 AW 5 bit 2	Brake resistor overload	Stop drive. Let resistor cool down. Check parameter settings of resistor overload protection function (see parameter group 27 BRAKE CHOPPER). Check that braking cycle meets allowed limits.
CALIBRA DONE (FF37)	Calibration of output current transformers is completed.	Continue normal operation.
CALIBRA REQ (FF36)	Calibration of output current transformers is required. Displayed at start if drive is in scalar control (parameter 99.04) and scalar fly start feature is on (parameter 21.08).	Calibration starts automatically. Wait for a while.

WARNING	CAUSE	WHAT TO DO
COMM MODULE (7510) 3.08 AW 1 bit 12 (programmable Fault Function 30.18, 30.19)	Cyclical communication between drive and master is lost.	Check status of fieldbus communication. See chapter <i>Fieldbus control</i> , or appropriate fieldbus adapter manual. Check parameter settings: - group 51 COMM MODULE DATA (for fieldbus adapter) - group 52 STANDARD MODBUS (for Standard Modbus Link). Check Fault Function parameters. Check cable connections. Check if master can communicate.
DC BUS LIM (3211) 3.18 AW5 bit 9 (programmable Fault Function 30.23)	Drive limits torque due to too high or too low intermediate circuit DC voltage.	Informative alarm Check Fault Function parameters.
EARTH FAULT (2330) 3.08 AW 1 bit 14 (programmable Fault Function 30.17)	Drive has detected load unbalance typically due to earth fault in motor or motor cable.	Check there are no power factor correction capacitors or surge absorbers in motor cable. Check that there is no earth fault in motor or motor cables: - measure insulation resistances of motor and motor cable. If no earth fault can be detected, contact your local ABB representative.
ENC CABLE (7310) 3.31 AW 6 bit 3 (programmable Fault Function 50.07)	Pulse encoder phase signal is missing.	Check pulse encoder and its wiring. Check pulse encoder interface module and its wiring.
ENCODER A<>B (7302) 3.09 AW 2 bit 4	Pulse encoder phasing is wrong: Phase A is connected to terminal of phase B and vice versa.	Interchange connection of pulse encoder phases A and B.
ENCODER ERR (7301) 3.08 AW 1 bit 5	Communication fault between pulse encoder and pulse encoder interface module and between module and drive	Check pulse encoder and its wiring, pulse encoder interface module and its wiring, parameter group 50 ENCODER MODULE settings.
FAN OTEMP (FF83) 3.16 AW 4 bit 0	Excessive temperature of drive output filter fan. Supervision is in use in step-up drives.	Stop drive. Let it cool down. Check ambient temperature. Check fan rotates in correct direction and air flows freely.
HW RECONF RQ (FF38)	Inverter type (e.g. sr0025_3) has been changed. Inverter type is usually changed at factory or during drive implementation.	Wait until alarm POWEROFF! activates and switch control board power off to validate inverter type change.



WARNING	CAUSE	WHAT TO DO
ID DONE (FF32)	Drive has performed motor identification magnetisation and is ready for operation. This warning belongs to normal start-up procedure.	Continue drive operation.
ID MAGN (FF31)	Motor identification magnetisation is on. This warning belongs to normal start-up procedure.	Wait until drive indicates that motor identification is completed.
ID MAGN REQ (FF30)	Motor identification is required. This warning belongs to normal start-up procedure. Drive expects user to select how motor identification should be performed: By Identification Magnetisation or by ID Run.	Start Identification Magnetisation by pressing Start key, or select ID Run and start (see parameter 99.10).
ID N CHANGED (FF68)	Drive ID number has been changed from 1.	Change ID number back to 1. See chapter <i>Control panel</i> .
ID RUN (FF35)	Motor identification Run is on.	Wait until drive indicates that motor identification Run is completed.
ID RUN SEL (FF33)	Motor Identification Run is selected, and drive is ready to start ID Run. This warning belongs to ID Run procedure.	Press Start key to start Identification Run.
IN CHOKE TEMP (FF81) 3.18 AW 5 bit 4	Excessive input choke temperature	Stop drive. Let it cool down. Check ambient temperature. Check that fan rotates in correct direction and air flows freely.
INV CUR LIM (2212) 3.18 AW 5 bit 8 (programmable Fault Function 30.23)	Internal inverter current or power limit has been exceeded.	Reduce load or increase ramp time. Limit inverter actual power or decrease line-side converter reactive power generation reference value (parameter 95.06 LCU Q PW REF). Check Fault Function parameters.
INV DISABLED (3200) 3.18 AW 5 bit 6	Optional DC switch has opened while unit was stopped.	Close DC switch. Check AFSC-0x Fuse Switch Controller unit.

WARNING	CAUSE	WHAT TO DO
INV OVERTEMP (4290) 3.31 AW 6 bit 0	Converter module temperature is excessive.	<p>Check ambient temperature. If it exceeds 40°C, ensure that load current does not exceed derated load capacity of drive. See appropriate hardware manual.</p> <p>Check that ambient temperature setting is correct (parameter 95.10).</p> <p>Check converter module cooling air flow and fan operation.</p> <p><u>Cabinet installation:</u> Check cabinet air inlet filters. Change when necessary. See appropriate hardware manual.</p> <p><u>Modules installed in cabinet by user:</u> Check that cooling air circulation in cabinet has been prevented with air baffles. See module installation instructions.</p> <p>Check inside of cabinet and heatsink of converter module for dust pick-up. Clean when necessary.</p>
IO CONFIG (FF8B) (programmable Fault Function 30.22)	Input or output of optional I/O extension or fieldbus module has been selected as signal interface in application program but communication to appropriate I/O extension module has not been set accordingly.	<p>Check Fault Function parameters.</p> <p>Check parameter group 98 OPTION MODULES.</p>
MACRO CHANGE (FF69)	Macro is restoring or User macro is being saved.	Wait until drive has finished task.
MOD BOARD T (FF88) 09.11 AW 3 bit 14	Overtemperature in AINT board of inverter module.	<p>Check inverter fan.</p> <p>Check ambient temperature.</p>
MOD CHOKE T (FF89) 09.11 AW 3 bit 13	Overtemperature in choke of liquid cooled R8i inverter module.	<p>Check inverter fan.</p> <p>Check ambient temperature.</p> <p>Check liquid cooling system.</p>
MOT CUR LIM (2300) 3.18 AW 5 bit 10 (programmable Fault Function 30.23)	Drive limits motor current according to current limit defined by parameter 20.03 MAXIMUM CURRENT .	<p>Reduce load or increase ramp time.</p> <p>Increase parameter 20.03 MAXIMUM CURRENT value.</p> <p>Check Fault Function parameters.</p>
MOTOR STALL (7121) 3.09 AW 2 bit 9 (programmable Fault Function 30.10)	Motor is operating in stall region due to e.g. excessive load or insufficient motor power.	<p>Check motor load and drive ratings.</p> <p>Check Fault Function parameters.</p>
MOTOR STARTS (FF34)	Motor Identification Run starts. This warning belongs to ID Run procedure.	Wait until drive indicates that motor identification is completed.

WARNING	CAUSE	WHAT TO DO
MOTOR TEMP (4310) 3.08 AW 1 bit 3 (programmable Fault Function 30.04...30.09)	Motor temperature is too high (or appears to be too high) due to excessive load, insufficient motor power, inadequate cooling or incorrect start-up data.	Check motor ratings, load and cooling. Check start-up data. Check Fault Function parameters.
MOTOR 1 TEMP (4312) 3.16 AW 4 bit 1	Measured motor temperature has exceeded alarm limit set by parameter 35.02.	Check value of alarm limit. Check that actual number of sensors corresponds to value set by parameter. Let motor cool down. Ensure proper motor cooling: Check cooling fan, clean cooling surfaces, etc.
MOTOR 2 TEMP (4313) 3.16 AW 4 bit 2	Measured motor temperature has exceeded alarm limit set by parameter 35.05.	Check value of alarm limit. Check that actual number of sensors corresponds to value set by parameter. Let motor cool down. Ensure proper motor cooling: Check cooling fan, clean cooling surfaces, etc.
MOT POW LIM (FF86) 3.18 AW 5 bit 12 (programmable Fault Function 30.23)	Drive limits motor power according to limits defined by parameters 20.11 and 20.12.	Informative alarm Check parameter 20.11 P MOTORING LIM and 20.12 P GENERATING LIM settings. Check Fault Function parameters.
MOT TORQ LIM (FF85) 3.18 AW 5 bit 11 (programmable Fault Function 30.23)	Drive limits motor torque according to calculated motor pull-out torque limit and minimum and maximum torque limits defined by parameters 20.13 and 20.14.	Informative alarm Check parameter 20.13 MIN TORQ SEL and 20.14 MAX TORQ SEL settings. Check Fault Function parameters. If LIMIT WORD 1 bit 0 TORQ MOTOR LIM is 1, - check motor parameter settings (parameter group 99 START-UP DATA) - ensure that ID run has been completed successfully.
PANEL LOSS (5300) 3.09 AW 2 bit 13 (programmable Fault Function 30.02)	Control panel selected as active control location for drive has ceased communicating.	Check panel connection (see appropriate hardware manual). Check control panel connector. Replace control panel in mounting platform. Check Fault Function parameters.
POINTER ERROR (FFD0)	Source selection (pointer) parameter points to non existing parameter index.	Check source selection (pointer) parameter settings.
->POWEROFF! (FF39)	Inverter type (e.g. sr0025_3) has been changed. Inverter type is usually changed at factory or during drive implementation.	Switch control board power off to validate inverter type change.

WARNING	CAUSE	WHAT TO DO
PPCC LINK (5210) 3.06 FW 2 bit 11	Fibre optic link to INT board is faulty.	Check fibre optic cables or galvanic link. With frame sizes R2-R6 link is galvanic. If RMIO is powered from external supply, ensure that supply is on. See parameter 16.09 CTRL BOARD SUPPLY . Check signal 03.19 . Contact ABB representative if any of faults in signal 3.19 are active.
PPCC LINK xx (5210) 3.06 FW 2 bit 11 and 4.01	INT board fibre optic connection fault in inverter unit of several parallel connected inverter modules. xx refers to inverter module number.	Check connection from inverter module Main Circuit Interface Board, INT to PPCC Branching Unit, PBU. (Inverter module 1 is connected to PBU INT1 etc.) Check signal 03.19 . Contact ABB representative if any of faults in signal 3.19 are active.
PP OVERLOAD (5482) 3.18 AW 5 bit 5	Excessive IGBT junction to case temperature. This can be caused by excessive load at low frequencies (e.g. fast direction change with excessive load and inertia).	Increase ramp time. Reduce load.
REPLACE FAN (4280) 3.18 AW 5 bit 0	Running time of inverter cooling fan has exceeded its estimated life time.	Replace fan. Reset fan run time counter 01.44 .
RUN ENABLE (FF8E) 3.06 FW 2 bit 4	No Run enable signal received.	Check setting of parameter 16.01 . Switch on signal or check wiring of selected source.
SLEEP MODE (FF8C) 3.16 AW 4 bit 4	Sleep function has entered sleeping mode.	See parameter group 40 PID CONTROL .
START INHIBI (FF7A) AW 1 bit 0	Safe torque off function has been activated while drive was stopped. <u>Or:</u> Optional start inhibit hardware logic is activated.	Close Safe torque off function switch. If switch is closed and warning is still active, check power supply at ASTO board input terminals. Replace ASTO board. <u>Or:</u> Check start inhibit circuit (AGPS board).
START INTERL (FF8D)	No Start Interlock signal received.	Check circuit connected to Start Interlock input on RMIO board.
SYNCRO SPEED (FF87) 3.18 AW 5 bit 1	Value of motor nominal speed set to parameter 99.08 is not correct: Value is too near synchronous speed of motor. Tolerance is 0.1%. This warning is active only in DTC mode.	Check nominal speed from motor rating plate and set parameter 99.08 exactly accordingly.

WARNING	CAUSE	WHAT TO DO
TEMP DIF xx y (4380) 4.01 FAULTED INT INFO	Excessive temperature difference between several parallel connected inverter modules. xx (1...12) refers to inverter module number and y refers to phase (U, V, W). Alarm is indicated when temperature difference is 15°C. Fault is indicated when temperature difference is 20°C. Excessive temperature can be caused e.g. by unequal current sharing between parallel connected inverters.	Check cooling fan. Replace fan. Check air filters.
THERMISTOR (4311) 3.08 AW 1 bit 2 (programmable Fault Function 30.04...30.05)	Motor temperature is excessive. Motor thermal protection mode selection is TEMP SENSOR.	Check motor ratings and load. Check start-up data. Check thermistor connections to digital input DI6.
T MEAS ALM (FF91) 3.08 AW 1 bit 6	Motor temperature measurement is out of acceptable range.	Check connections of motor temperature measurement circuit. See chapter <i>Program features</i> for circuit diagram.
UNDERLOAD (FF6A) 3.09 AW 2 bit 1 (programmable Fault Function 30.13)	Motor load is too low due to e.g. release mechanism in driven equipment.	Check for problem in driven equipment. Check Fault Function parameters.
USER L CURVE (2312) 3.18 AW 5 bit 13	Integrated motor current has exceeded load curve defined by parameters in group 72 USER LOAD CURVE .	Check parameter group 72 USER LOAD CURVE settings. Reduce load.

Warning messages generated by the control panel

WARNING	CAUSE	WHAT TO DO
DOWNLOADING FAILED	Download function of panel has failed. No data has been copied from panel to drive.	Make sure panel is in local mode. Retry (there might be interference on link). Contact ABB representative.
DRIVE IS RUNNING DOWNLOADING NOT POSSIBLE	Downloading is not possible while motor is running.	Stop motor. Perform downloading.
NO COMMUNICATION (X)	Cabling problem or hardware malfunction on Panel Link	Check Panel Link connections. Press RESET key. Panel reset may take up to half a minute, please wait.
	(4) = Panel type not compatible with drive application program version	Check panel type and drive application program version. Panel type is printed on panel cover. Application program version is stored in parameter 33.02.
NO FREE ID NUMBERS ID NUMBER SETTING NOT POSSIBLE	Panel Link already includes 31 stations.	Disconnect another station from link to free ID number.
NOT UPLOADED DOWNLOADING NOT POSSIBLE	No upload function has been performed.	Perform upload function before downloading. See chapter Control panel .
UPLOADING FAILED	Upload function of panel has failed. No data has been copied from drive to panel.	Retry (there might be interference on link). Contact ABB representative.
WRITE ACCESS DENIED PARAMETER SETTING NOT POSSIBLE	Certain parameters do not allow changes while motor is running. If tried, no change is accepted, and warning is displayed.	Stop motor, then change parameter value.
	Parameter lock is on.	Open parameter lock (see parameter 16.02).

Fault messages generated by the drive

FAULT	CAUSE	WHAT TO DO
ACS800 TEMP (4210) 3.05 FW 1 bit 3	Drive IGBT temperature is excessive. Fault trip limit is 100%.	Check ambient conditions. Check air flow and fan operation. Check heatsink fins for dust pick-up. Check motor power against unit power.
ACS TEMP xx y (4210) 3.05 FW 1 bit 3 and 4.01	Excessive internal temperature in inverter unit of several parallel connected inverter modules. xx (1...12) refers to inverter module number and y refers to phase (U, V, W).	Check ambient conditions. Check air flow and fan operation. Check heatsink fins for dust pick-up. Check motor power against unit power.
AI < MIN FUNC (8110) 3.06 FW 2 bit 10 (programmable Fault Function 30.01)	Analogue control signal is below minimum allowed value due to incorrect signal level or failure in control wiring.	Check for proper analogue control signal levels. Check control wiring. Check Fault Function parameters.
AD [message]	Message generated by an EVENT block in the Adaptive Program.	Consult the documentation or author of the Adaptive Program.
BACKUP ERROR (FFA2)	Failure when restoring PC stored backup of drive parameters.	Retry. Check connections. Check that parameters are compatible with drive.
BC OVERHEAT (7114) 3.17 FW 5 bit 4	Brake chopper overload	Let chopper cool down. Check parameter settings of resistor overload protection function (see parameter group 27 BRAKE CHOPPER). Check that braking cycle meets allowed limits. Check that drive supply AC voltage is not excessive.
BC SHORT CIR (7113) 3.17 FW 5 bit 2	Short circuit in brake chopper IGBT(s)	Replace brake chopper. Ensure brake resistor is connected and not damaged.
BRAKE ACKN (FF74) 3.15 FW 4 bit 3	Unexpected state of brake acknowledge signal	See parameter group 42 BRAKE CONTROL . Check connection of brake acknowledgement signal.
BR BROKEN (7110) 3.17 FW 5 bit 0	Brake resistor is not connected or it is damaged. Resistance rating of brake resistor is too high.	Check resistor and resistor connection. Check that resistance rating meets specifications. See appropriate drive hardware manual.

FAULT	CAUSE	WHAT TO DO
BR OVERHEAT (7112) 3.17 FW 5 bit 3	Brake resistor overload	Let resistor cool down. Check parameter settings of resistor overload protection function (see parameter group 27 BRAKE CHOPPER). Check that braking cycle meets allowed limits. Check that drive supply AC voltage is not excessive.
BR WIRING (7111) 3.17 FW 5 bit 1	Wrong connection of brake resistor	Check resistor connection. Ensure brake resistor is not damaged.
CHOKE OTEMP (FF82)	Excessive temperature of drive output filter. Supervision is in use in step-up drives.	Let drive cool down. Check ambient temperature. Check filter fan rotates in correct direction and air flows freely.
COMM MODULE (7510) 3.06 FW 2 bit 12 (programmable Fault Function 30.18 , 30.19)	Cyclical communication between drive and master is lost.	Check status of fieldbus communication. See chapter Fieldbus control , or appropriate fieldbus adapter manual. Check parameter settings: - group 51 COMM MODULE DATA (for fieldbus adapter), or - group 52 STANDARD MODBUS (for Standard Modbus Link). Check Fault Function parameters. Check cable connections. Check if master can communicate.
CTRL B TEMP (4110) 3.06 FW 2 bit 7	Control board temperature is above 88°C.	Check ambient conditions. Check air flow. Check main and additional cooling fans.
CURR MEAS (2211)	Current transformer failure in output current measurement circuit	Check current transformer connections to Main Circuit Interface Board, INT.
CUR UNBAL xx (2330) 3.05 FW 1 bit 4 and 4.01 (programmable Fault Function 30.17)	Drive has detected excessive output current unbalance in inverter unit of several parallel connected inverter modules. This can be caused by external fault (earth fault, motor, motor cabling, etc.) or internal fault (damaged inverter component). xx (1...12) refers to inverter module number.	Check there are no power factor correction capacitors or surge absorbers in motor cable. Check that there is no earth fault in motor or motor cables: - measure insulation resistances of motor and motor cable. If no earth fault can be detected, contact your local ABB representative.
DC HIGH RUSH (FF80)	Drive supply voltage is excessive. When supply voltage is over 124% of unit voltage rating (415, 500 or 690 V), motor speed rushes to trip level (40% of nominal speed).	Check supply voltage level, drive rated voltage and allowed voltage range of drive.

FAULT	CAUSE	WHAT TO DO
DC OVERVOLT (3210) 3.05 FW 1 bit 2	Excessive intermediate circuit DC voltage. DC overvoltage trip limit is $1.3 \times 1.35 \times U_{1max}$, where U_{1max} is maximum value of supply voltage range. For 400 V units, U_{1max} is 415 V. For 500 V units, U_{1max} is 500 V. For 690 V units, U_{1max} is 690 V. Actual voltage in intermediate circuit corresponding to the supply voltage trip level is 728 V DC for 400 V units, 877 V DC for 500 V units, and 1210 V DC for 690 V units.	Check that overvoltage controller is on (parameter 20.05). Check supply voltage for static or transient overvoltage. Check brake chopper and resistor (if used). Check deceleration time. Use coast-to-stop function (if applicable). Retrofit frequency converter with brake chopper and brake resistor.
DC UNDERVOLT (3220) 3.06 FW 2 bit 2	Intermediate circuit DC voltage is not sufficient due to missing supply voltage phase, blown fuse or rectifier bridge internal fault. DC undervoltage trip limit is $0.6 \times 1.35 \times U_{1min}$, where U_{1min} is minimum value of supply voltage range. For 400 V and 500 V units, U_{1min} is 380 V. For 690 V units, U_{1min} is 525 V. Actual voltage in intermediate circuit corresponding to supply voltage trip level is 307 V DC for 400 V and 500 V units, and 425 V DC for 690 V units.	Check main supply and fuses.
EARTH FAULT (2330) 3.05 FW 1 bit 4 (programmable Fault Function 30.17)	Drive has detected load unbalance typically due to earth fault in motor or motor cable.	Check there are no power factor correction capacitors or surge absorbers in motor cable. Check that there is no earth fault in motor or motor cables: - measure insulation resistances of motor and motor cable. If no earth fault can be detected, contact your local ABB representative.
ENC CABLE (7310) 3.33 FW 6 bit 2 (programmable Fault Function 50.07)	Pulse encoder phase signal is missing.	Check pulse encoder and its wiring. Check pulse encoder interface module and its wiring.
ENCODER A<>B (7302)	Pulse encoder phasing is wrong: Phase A is connected to terminal of phase B and vice versa.	Interchange connection of pulse encoder phases A and B.
ENCODER ERR (7301) 3.06 FW 2 bit 5	Communication fault between pulse encoder and pulse encoder interface module and between module and drive	Check pulse encoder and its wiring, pulse encoder interface module and its wiring and parameter group 50 ENCODER MODULE settings.
EXTERNAL FLT (9000) 3.06 FW 2 bit 8 (programmable Fault Function 30.03)	Fault in external device. (This information is configured through one of programmable digital inputs.)	Check external devices for faults. Check parameter 30.03 EXTERNAL FAULT.

FAULT	CAUSE	WHAT TO DO
FORCED TRIP (FF8F)	Generic Drive Communication Profile trip command	See appropriate communication module manual.
GD DISABLED (FF53)	AGPS power supply of parallel connected R8i inverter module has been switched off during run. X (1...12) refers to inverter module number.	Check Prevention of Unexpected Start-up circuit. Replace AGPS board of R8i inverter module.
ID RUN FAIL (FF84)	Motor ID Run is not completed successfully.	Check maximum speed (parameter 20.02). It should be at least 80% of motor nominal speed (parameter 99.08).
IN CHOKE TEMP (FF81) 3.17 FW 5 bit 5	Excessive input choke temperature	Stop drive. Let it cool down. Check ambient temperature. Check that fan rotates in correct direction and air flows freely.
INT CONFIG (5410) 03.17 FW 5 bit 10	Number of inverter modules is not equal to original number of inverters.	Check status of inverters. See signal 04.01 FAULTED INT INFO . Check fibre optic cables between APBU and inverter modules. If Reduced Run function is used, remove faulted inverter module from main circuit and write number of remaining inverter modules into parameter 95.03 INT CONFIG USER. Reset drive.
INV DISABLED 03.17 FW 5 bit 7 (3200)	Optional DC switch has opened while unit was running or start command was given.	Close DC switch. Check AFSC-0x Fuse Switch Controller unit.
INV OVERTEMP (4290) 3.17 FW 5 bit 13	Converter module temperature is excessive.	Check ambient temperature. If it exceeds 40°C, ensure that load current does not exceed derated load capacity of drive. See appropriate hardware manual. Check that ambient temperature setting is correct (parameter 95.10). Check converter module cooling air flow and fan operation. <u>Cabinet installation:</u> Check cabinet air inlet filters. Change when necessary. See appropriate hardware manual. <u>Modules installed in cabinet by user:</u> Check that cooling air circulation in cabinet has been prevented with air baffles. See module installation instructions. Check inside of cabinet and heatsink of converter module for dust pick-up. Clean when necessary. Reset and restart after problem is solved and let converter module cool down.

FAULT	CAUSE	WHAT TO DO
I/O COMM ERR (7000) 3.06 FW 2 bit 6	Communication error on control board, channel CH1 Electromagnetic interference	Check connections of fibre optic cables on channel CH1. Check all I/O modules (if present) connected to channel CH1. Check for proper earthing of equipment. Check for highly emissive components nearby.
LINE CONV (FF51)	Fault on line side converter	Shift panel from motor side converter control board to line side converter control board. See line side converter manual for fault description.
MOD BOARD T (FF88)	Overtemperature in AINT board of inverter module.	Check inverter fan. Check ambient temperature.
MOD CHOKE T (FF89)	Overtemperature in choke of liquid cooled R8i inverter module.	Check inverter fan. Check ambient temperature. Check liquid cooling system.
MOTOR PHASE (FF56) 3.06 FW 2 bit 15 (programmable Fault Function 30.16)	One of motor phases is lost due to fault in motor, motor cable, thermal relay (if used) or internal fault.	Check motor and motor cable. Check thermal relay (if used). Check Fault Function parameters. Disable this protection.
MOTOR STALL (7121) 3.06 FW 2 bit 14 (programmable Fault Function 30.10...30.12)	Motor is operating in stall region due to e.g. excessive load or insufficient motor power.	Check motor load and drive ratings. Check Fault Function parameters.
MOTOR TEMP (4310) 3.05 FW 1 bit 6 (programmable Fault Function 30.04...30.09)	Motor temperature is too high (or appears to be too high) due to excessive load, insufficient motor power, inadequate cooling or incorrect start-up data.	Check motor ratings and load. Check start-up data. Check Fault Function parameters.
MOTOR 1 TEMP (4312) 3.15 FW 4 bit 1	Measured motor temperature has exceeded fault limit set by parameter 35.03.	Check value of fault limit. Let motor cool down. Ensure proper motor cooling: Check cooling fan, clean cooling surfaces, etc.
MOTOR 2 TEMP (4313) 3.15 FW 4 bit 2	Measured motor temperature has exceeded fault limit set by parameter 35.06.	Check value of fault limit. Let motor cool down. Ensure proper motor cooling: Check cooling fan, clean cooling surfaces, etc.
NO MOT DATA (FF52) 3.06 FW 2 bit 1	Motor data is not given or motor data does not match with inverter data.	Check motor data parameters 99.04...99.09.

FAULT	CAUSE	WHAT TO DO
OVERCURR xx (2310) 3.05 FW 1 bit 1 and 4.01	Overcurrent fault in inverter unit of several parallel connected inverter modules. xx (1...12) refers to inverter module number.	Check motor load. Check acceleration time. Check motor and motor cable (including phasing). Check encoder cable (including phasing). Check motor nominal values from group 99 START-UP DATA to confirm that motor model is correct. Check that there are no power factor correction or surge absorbers in motor cable.
OVERCURRENT (2310) 3.05 FW 1 bit 1	Output current exceeds trip limit.	Check motor load. Check acceleration time. Check motor and motor cable (including phasing). Check that there are no power factor correction capacitors or surge absorbers in motor cable. Check encoder cable (including phasing).
OVERFREQ (7123) 3.05 FW 1 bit 9	Motor is turning faster than highest allowed speed due to incorrectly set minimum/maximum speed, insufficient braking torque or changes in load when using torque reference. Trip level is 50 Hz over operating range absolute maximum speed limit (Direct Torque Control mode active) or frequency limit (Scalar Control active). Operating range limits are set by parameters 20.01 and 20.02 (DTC mode active) or 20.07 and 20.08 (Scalar Control active).	Check minimum/maximum speed settings. Check adequacy of motor braking torque. Check applicability of torque control. Check need for brake chopper and resistor(s).
OVER SWFREQ (FF55) 3.06 FW 2 bit 9	Switching frequency is too high.	Check motor parameter settings (parameter group 99 START-UP DATA) Ensure that ID run has been completed successfully.
PANEL LOSS (5300) 3.06 FW 2 bit 13 (programmable Fault Function 30.02)	Control panel or DriveWindow selected as active control location for drive has ceased communicating.	Check panel connection (see appropriate hardware manual). Check control panel connector. Replace control panel in mounting platform. Check Fault Function parameters. Check DriveWindow connection.
PARAM CRC (6320)	CRC (Cyclic Redundancy Check) error	Switch control board power off and on again. Reload firmware to control board. Replace control board.
POWERFAIL (3381) 3.17 FW 5 bit 9	INT board powerfail in several inverter units of parallel connected inverter modules.	Check that INT board power cable is connected. Check that POW board is working correctly. Replace INT board.



FAULT	CAUSE	WHAT TO DO
POWERF INV xx (3381) 3.17 FW 5 bit 9 and 4.01	INT board powerfail in inverter unit of several parallel connected inverter modules. xx (1...12) refers to inverter module number.	Check that INT board power cable is connected. Check that POW board is working correctly. Replace INT board.
PPCC LINK (5210) 3.06 FW 2 bit 11	Fibre optic link to INT board is faulty.	Check fibre optic cables or galvanic link. With frame sizes R2-R6 link is galvanic. If RMIO is powered from external supply, ensure that supply is on. See parameter 16.09 CTRL BOARD SUPPLY. Check signal 03.19. Contact ABB representative if any of faults in signal 3.19 are active.
PPCC LINK xx (5210) 3.06 FW 2 bit 11 and 4.01	INT board fibre optic connection fault in inverter unit of several parallel connected inverter modules. xx refers to inverter module number.	Check connection from inverter module Main Circuit Interface Board, INT to PPCC Branching Unit, PBU. (Inverter module 1 is connected to PBU INT1 etc.) Check signal 03.19. Contact ABB representative if any of faults in signal 3.19 are active.
PP OVERLOAD (5482) 3.17 FW 5 bit 6	Excessive IGBT junction to case temperature. This fault protects IGBT(s) and it can be activated by short circuit at output of long motor cables.	Check motor cables.
SC INV xx y (2340) 3.05 FW 1 bit 0, 4.01 and 4.02	Short circuit in inverter unit of several parallel connected inverter modules. xx (1...12) refers to inverter module number and y refers to phase (U, V, W).	Check motor and motor cable. Check power semiconductors (IGBTs) of inverter module.
SHORT CIRC (2340) 3.05 FW 1 bit 0 and 4.02	Short-circuit in motor cable(s) or motor Output bridge of converter unit is faulty.	Check motor and motor cable. Check there are no power factor correction capacitors or surge absorbers in motor cable. Contact ABB representative.
SLOT OVERLAP (FF8A)	Two option modules have same connection interface selection.	Check connection interface selections in group 98 OPTION MODULES.
START INHIBI (FF7A) 3.03 bit 8	Safe torque off has been activated during motor run or motor start command has been given when Safe torque off is active. <u>Or:</u> Optional start inhibit hardware logic is activated.	Close Safe torque off switch. If switch is closed and fault is still active, check power supply at ASTO board input terminals. Replace ASTO board. <u>Or:</u> Check start inhibit circuit (AGPS board).
SUPPLY PHASE (3130) 3.06 FW 2 bit 0	Intermediate circuit DC voltage is oscillating due to missing supply voltage phase, blown fuse or rectifier bridge internal fault. Trip occurs when DC voltage ripple is 13% of DC voltage.	Check main supply fuses. Check for main supply imbalance.

FAULT	CAUSE	WHAT TO DO
TEMP DIF xx y (4380) 3.17 FW 5 bit 8 and 4.01	Excessive temperature difference between several parallel connected inverter modules. xx (1...12) refers to inverter module number and y refers to phase (U, V, W). Alarm is indicated when temperature difference is 15°C. Fault is indicated when temperature difference is 20°C Excessive temperature can be caused e.g. by unequal current sharing between parallel connected inverters.	Check cooling fan. Replace fan. Check air filters.
THERMAL MODE (FF50)	Motor thermal protection mode is set to DTC for high-power motor.	See parameter 30.05 .
THERMISTOR (4311) 3.05 FW 1 bit 5 (programmable Fault Function 30.04...30.05)	Motor temperature is excessive. Motor thermal protection mode selection is TEMP SENSOR.	Check motor ratings and load. Check start-up data. Check thermistor connections to digital input DI6.
UNDERLOAD (FF6A) 3.05 FW 1 bit 8 (programmable Fault Function 30.13...30.15)	Motor load is too low due to e.g. release mechanism in driven equipment.	Check for problem in driven equipment. Check Fault Function parameters.
USER L CURVE (2312) 3.17 FW 5 bit 11	Integrated motor current has exceeded load curve defined by parameter group 72 USER LOAD CURVE .	Check parameter group 72 USER LOAD CURVE settings. After motor cooling time specified by parameter 72.20 LOAD COOLING TIME has elapsed, fault can be reset.
USER MACRO (FFA1) 3.07 SFW bit 1	No User Macro saved or file is defective.	Create User Macro.

www.nicsanat.com

021-87700210

NIC SANAT

نیک صنعت



Analogue Extension Module

Chapter overview

The chapter describes the use of analogue extension module RAIO as an speed reference interface of ACS800 equipped with Standard Control Program.

Speed control through the analogue extension module

Two variants are described:

- Bipolar Input in Basic Speed Control
- Bipolar Input in Joystick Mode

Only the use of a bipolar input (\pm signal range) is covered here. The use of unipolar input corresponds to that of a standard unipolar input when:

- the settings described below are done, and
- the communication between the module and the drive is activated by parameter [98.06](#).

Basic checks

Ensure the drive is:

- installed and commissioned, and
- the external start and stop signals are connected.

Ensure the extension module:

- settings are adjusted. (See below.)
- is installed and reference signal is connected to AI1.
- is connected to the drive.

Settings of the analogue extension module and the drive

- Set the module node address to 5 (not required if installed to the option slot of the drive).
- Select the signal type for the module input AI1 (switch).
- Select the operation mode (unipolar/bipolar) of the module input (switch).
- Ensure the drive parameter settings correspond to the mode of the module inputs (parameter [98.13](#) and [98.14](#)).
- Set the drive parameters (see the appropriate section on the following pages).

Parameter settings: bipolar input in basic speed control

The table below lists the parameters that affect the handling of the speed reference received through the extension module bipolar input AI1 (AI5 of the drive).

Parameter	Setting
98.06 AI/O EXT MODULE	RAIO-SLOT1
98.13 AI/O EXT AI1 FUNC	BIPO AI5
10.03 DIRECTION	FORWARD; REVERSE; REQUEST ⁽¹⁾
11.02 EXT1/EXT2 SELECT	EXT1
11.03 EXT REF1 SELECT	AI5
11.04 EXT REF1 MINIMUM	minREF1
11.05 EXT REF1 MAXIMUM	maxREF1
13.16 MINIMUM AI5	minAI5
13.17 MAXIMUM AI5	maxAI5
13.18 SCALE AI5	100%
13.20 INVERT AI5	NO
30.01 AI<MIN FUNCTION	⁽²⁾

The figure below presents the speed reference corresponding to bipolar input AI1 of the extension module.

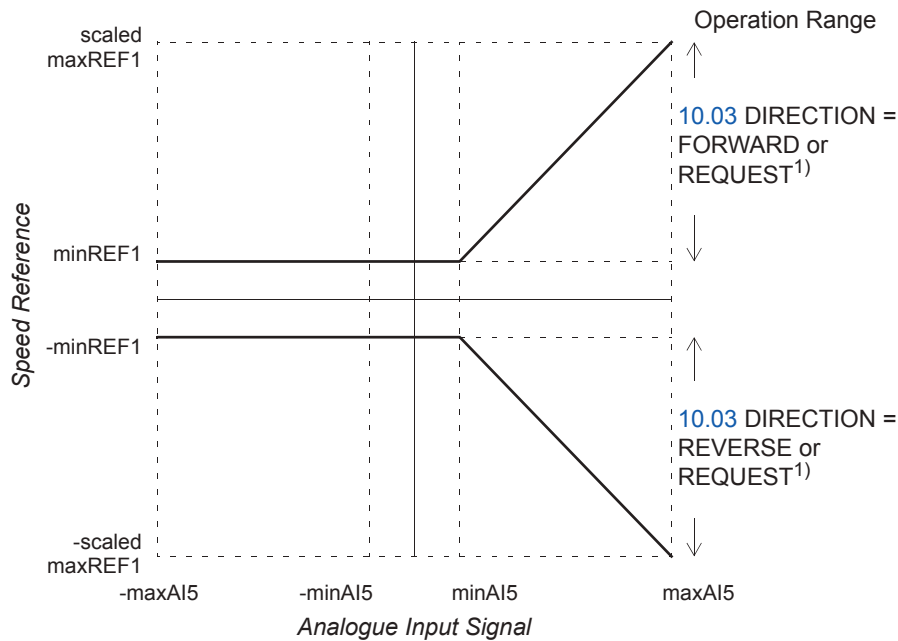

minAI5 = 13.16 MINIMUM AI5
maxAI5 = 13.17 MAXIMUM AI5
scaled maxREF1 = 13.18 SCALE AI5 x 11.05 EXT REF1 MAXIMUM
minREF1 = 11.04 EXT REF1 MINIMUM

- 1) For the negative speed range, the drive must receive a separate reverse command.
2) Set if supervision of living zero is used.

Parameter settings: bipolar input in joystick mode

The table below lists the parameters that affect the handling of the speed and direction reference received through the extension module bipolar input AI1 (AI5 of the drive).

Parameter	Setting
98.06 AI/O EXT MODULE	RAIO-SLOT1
98.13 AI/O EXT AI1 FUNC	BIPO AI5
10.03 DIRECTION	FORWARD; REVERSE; REQUEST ⁽¹⁾
11.02 EXT1/EXT2 SELECT	EXT1
11.03 EXT REF1 SELECT	AI5/JOYST
11.04 EXT REF1 MINIMUM	minREF1
11.05 EXT REF1 MAXIMUM	maxREF1
13.16 MINIMUM AI5	minAI5
13.17 MAXIMUM AI5	maxAI5
13.18 SCALE AI5	100%
13.20 INVERT AI5	NO
30.01 AI<MIN FUNCTION	⁽²⁾

The figure below presents the speed reference corresponding to bipolar input AI1 of the extension module in joystick mode.

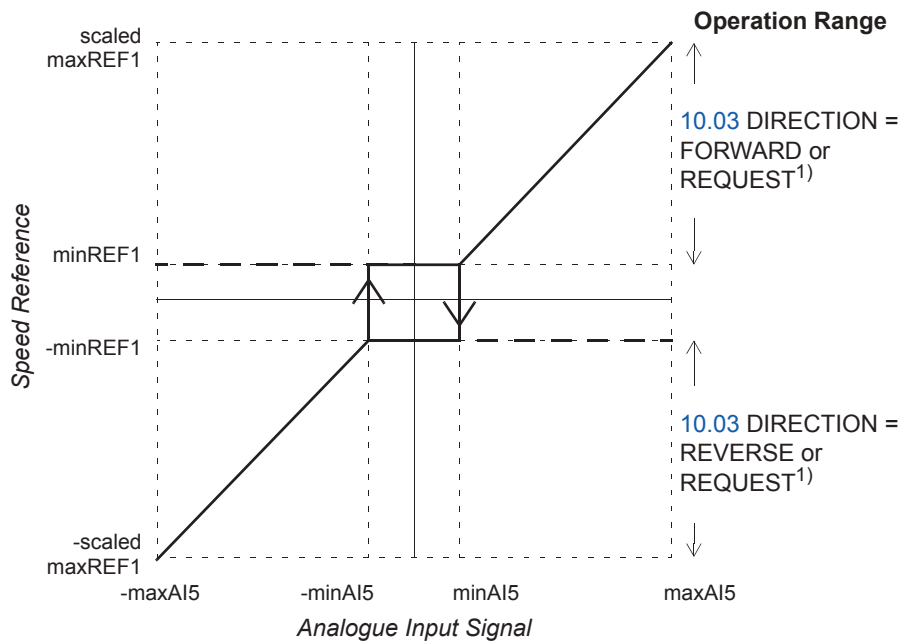

minAI5	=	13.15 MINIMUM AI5
maxAI5	=	13.17 MAXIMUM AI5
scaled maxREF1	=	13.18 SCALE AI5 x 11.05 EXT REF1 MAXIMUM
minREF1	=	11.04 EXT REF1 MINIMUM

¹⁾ Enables the use of both positive and negative speed range.

²⁾ Set if supervision of living zero is used.

www.nicsanat.com

021-87700210

NIC SANAT

نیک صنعت



Additional data: actual signals and parameters

Chapter overview

This chapter lists the actual signal and parameter lists with some additional data. For the descriptions, see chapter [Actual signals and parameters](#).

Terms and abbreviations

Term	Definition
PB	Profibus equivalent for drive parameters communicating through the NPBA-12 Profibus Adapter.
FbEq	Fieldbus equivalent: The scaling between the value shown on the panel and the integer used in serial communication.
Absolute Maximum Frequency	Value of 20.08 , or 20.07 if the absolute value of the minimum limit is greater than the maximum limit.
Absolute Maximum Speed	Value of parameter 20.02 , or 20.01 if the absolute value of the minimum limit is higher than the maximum limit.
W	Write access is not allowed when the motor is running.

Fieldbus addresses

Rxxx adapter modules (such as RPBA-01, RDNA-01, etc.)

See the appropriate fieldbus adapter module User's Manual.

Nxxx adapter modules (such as NPBA-12, NDNA-02, etc.)

NPBA-12 Profibus Adapter

All versions

- see column PB in the tables below.

Version 1.5 or later

- see *NPBA-12 PROFIBUS Adapter Installation and Start-Up Guide* [3BFE64341588 (English)].

Reading or writing a drive parameter can be done also by converting the parameter group (PNU) and the parameter index (subindex) into hexadecimal.

Example: drive parameter 12.07:

12 = 0C(hex)

07 = 07(hex) => 0C07.

Request label for request parameter value is 6. Request label for change parameter value is 7. **Note:** Not every parameter has Profibus equivalent value (PB).

NIBA-01 InterBus-S Adapter

- $xyyy \cdot 100 + 12288$ converted into hexadecimal, where $xyyy$ = drive parameter number
Example: The index number for drive parameter 13.09 is $1309 + 12288 = 13597$ (dec) = 351D (hex)

NMBP-01 ModbusPlus® Adapter and NMBA-01 Modbus Adapter

- $4xyyy$, where $xyyy$ = drive parameter number

Actual signals

Index	Name	Short name	FbEq	Unit	Range	PB	
01	ACTUAL SIGNALS						
01.01	PROCESS VARIABLE	PROC VAR	1 = 1	According to parameter 34.02		1	
01.02	SPEED	SPEED	-20000 = -100% 20000 = 100% of motor absolute max. speed	rpm		2	
01.03	FREQUENCY	FREQ	-100 = -1 Hz 100 = 1 Hz	Hz		3	
01.04	CURRENT	CURRENT	10 = 1 A	A		4	
01.05	TORQUE	TORQUE	-10000 = -100% 10000 = 100% of motor nominal torque	%		5	
01.06	POWER	POWER	-1000 = -100% 1000 = 100% of motor nominal power	%		6	
01.07	DC BUS VOLTAGE V	DC BUS V	1 = 1 V	V		7	
01.08	MAINS VOLTAGE	MAINS V	1 = 1 V	V		8	
01.09	OUTPUT VOLTAGE	OUT VOLT	1 = 1 V	V		9	
01.10	ACS800 TEMP	ACS TEMP	10 = 1%	%		10	
01.11	EXTERNAL REF 1	EXT REF1	1 = 1 rpm	rpm		11	
01.12	EXTERNAL REF 2	EXT REF2	0 = 0% 10000 = 100% 1)	%		12	
01.13	CTRL LOCATION	CTRL LOC	(1,2) LOCAL; (3) EXT1; (4) EXT2		LOCAL; EXT1; EXT2	13	
01.14	OP HOUR COUNTER	OP HOURS	1 = 1 h	h		14	
01.15	KILOWATT HOURS	KW HOURS	1 = 100 kWh	kWh		15	
01.16	APPL BLOCK OUTPUT	APPL OUT	0 = 0% 10000 = 100%	%		16	
01.17	DI6-1 STATUS	DI6-1	1 = 1			17	
01.18	AI1 [V]	AI1 [V]	1 = 0.001 V	V		18	
01.19	AI2 [mA]	AI2 [mA]	1 = 0.001 mA	mA		19	
01.20	AI3 [mA]	AI3 [mA]	1 = 0.001 mA	mA		20	
01.21	RO3-1 STATUS	RO3-1	1 = 1			21	
01.22	AO1 [mA]	AO1 [mA]	1 = 0.001 mA	mA		22	
01.23	AO2 [mA]	AO2 [mA]	1 = 0.001 mA	mA		23	
01.24	ACTUAL VALUE 1	ACT VAL1	0 = 0% 10000 = 100%	%		24	
01.25	ACTUAL VALUE 2	ACT VAL2	0 = 0% 10000 = 100%	%		25	
01.26	CONTROL DEVIATION	CONT DEV	-10000 = -100% 10000 = 100%	%		26	
01.27	APPLICATION MACRO	MACRO	1 ... 7		According to parameter 99.02	27	
01.28	EXT AO1 [mA]	EXT AO1	1 = 0.001 mA	mA		28	
01.29	EXT AO2 [mA]	EXT AO2	1 = 0.001 mA	mA		29	
01.30	PP 1 TEMP	PP 1 TEM	1 = 1°C	°C		30	
01.31	PP 2 TEMP	PP 2 TEM	1 = 1°C	°C		31	
01.32	PP 3 TEMP	PP 3 TEM	1 = 1°C	°C		32	
01.33	PP 4 TEMP	PP 4 TEM	1 = 1°C	°C		33	
01.34	ACTUAL VALUE	ACT V	0 = 0% 10000 = 100%	%		34	
01.35	MOTOR 1 TEMP	M 1 TEMP	1 = 1°C/ohm	°C		35	
01.36	MOTOR 2 TEMP	M 2 TEMP	1 = 1°C/ohm	°C		36	
01.37	MOTOR TEMP EST	MOTOR TE	1 = 1°C	°C		37	
01.38	AI5 [mA]	AI5 [mA]	1 = 0.001 mA	mA		38	

Index	Name	Short name	FbEq	Unit	Range	PB
01.39	AI6 [mA]	AI6 [mA]	1 = 0.001 mA	mA		39
01.40	DI7-12 STATUS	DI7...12	1 = 1			40
01.41	EXT RO STATUS	EXT RO	1 = 1			41
01.42	PROCESS SPEED REL	P SPEED	1 = 1	%		42
01.43	MOTOR RUN TIME	MOTOR RUN TIME	1 = 10 h	h		43
01.44	FAN ON-TIME	FAN TIME	10 h = 1	h		44
01.45	CTRL BOARD TEMP	CTRL B T	1 = 1	°C		45
01.46	SAVED KWH	SAV KWH	1 = 100 kWh	kWh	0...999 999	46
01.47	SAVED GWH	SAV GWH	1 = 1 GWh	GWh	1...8388607	47
01.48	SAVED AMOUNT	SAV AM	1 = 100 cur	local; EUR; USD	0...999 999	48
01.49	SAVED AMOUNT M	SAV AM M	1 = 1 Mcur	local; EUR; USD	1...8388607	49
01.50	SAVED CO2	SAV CO2	1 = 100 kg	kg	0...999 999	50
01.51	SAVED CO2 KTON	SAV CO2K	1 = 1 kton	kton	1...8388607	-
02	ACTUAL SIGNALS					
02.01	SPEED REF 2	S REF 2	0 = 0% 20000 =	rpm		51
02.02	SPEED REF 3	S REF 3	100% of motor absolute max. speed	rpm		52
02.09	TORQUE REF 2	T REF 2	0 = 0% 10000 =	%		59
02.10	TORQUE REF 3	T REF 3	100% of motor nominal torque	%		60
02.13	TORQ USED REF	T USED R		%		63
02.14	FLUX REF	FLUX REF	0 = 0% 10000 = 100%	%		64
02.17	SPEED ESTIMATED	SPEED ES	0 = 0% 20000 =	rpm		67
02.18	SPEED MEASURED	SPEED ME	100% of motor absolute max. speed	rpm		68
02.19	MOTOR ACCELERATIO	MOTOR AC	1 = 1 rpm/s.	rpm/s		69
02.20	USER CURRENT	USER CUR	10 = 1%	%		70
03	ACTUAL SIGNALS		2)			
03.01	MAIN CTRL WORD	MAIN CW			0...65535 (Decimal)	76
03.02	MAIN STATUS WORD	MAIN SW			0...65535 (Decimal)	77
03.03	AUX STATUS WORD	AUX SW			0...65535 (Decimal)	78
03.04	LIMIT WORD 1	LIMIT W1			0...65535 (Decimal)	79
03.05	FAULT WORD 1	FAULT W1			0...65535 (Decimal)	80
03.06	FAULT WORD 2	FAULT W2			0...65535 (Decimal)	81
03.07	SYSTEM FAULT	SYS FLT			0...65535 (Decimal)	82
03.08	ALARM WORD 1	ALARM W1			0...65535 (Decimal)	83
03.09	ALARM WORD 2	ALARM W2			0...65535 (Decimal)	84
03.11	FOLLOWER MCW	FOLL MCW			0...65535 (Decimal)	86
03.13	AUX STATUS WORD 3	AUX SW 3			0...65535 (Decimal)	88
03.14	AUX STATUS WORD 4	AUX SW 4			0...65535 (Decimal)	89
03.15	FAULT WORD 4	FAULT W4			0...65535 (Decimal)	90
03.16	ALARM WORD 4	ALARM W4			0...65535 (Decimal)	91

Additional data: actual signals and parameters

Index	Name	Short name	FbEq	Unit	Range	PB
03.17	FAULT WORD 5	FAULT W5			0...65535 (Decimal)	92
03.18	ALARM WORD 5	ALARM W5			0...65535 (Decimal)	93
03.19	INT INIT FAULT	INT INIT			0...65535 (Decimal)	94
03.20	LATEST FAULT	LAST FLT			0...65535 (Decimal)	95
03.21	2.LATEST FAULT	2.FAULT			0...65535 (Decimal)	96
03.22	3.LATEST FAULT	3.FAULT			0...65535 (Decimal)	97
03.23	4.LATEST FAULT	4.FAULT			0...65535 (Decimal)	98
03.24	5.LATEST FAULT	5.FAULT			0...65535 (Decimal)	99
03.25	LATEST WARNING	LAST WRN			0...65535 (Decimal)	100
03.26	2.LATEST WARNING	2.WARN			0...65535 (Decimal)	
03.27	3.LATEST WARNING	3.WARN			0...65535 (Decimal)	
03.28	4.LATEST WARNING	4.WARN			0...65535 (Decimal)	
03.29	5.LATEST WARNING	5.WARN			0...65535 (Decimal)	
03.30	LIMIT WORD INV	LIMIT WO			0...65535 (Decimal)	-
03.31	ALARM WORD 6	ALARM W6			0...65535 (Decimal)	-
03.32	EXT IO STATUS	E IO ST	-	-	0...65535 (Decimal)	-
03.33	FAULT WORD 6	FAULT W6			0...65535 (Decimal)	
04	ACTUAL SIGNALS					
04.01	FAULTED INT INFO	FLTD INT			0...65535 (Decimal)	
04.02	INT SC INFO	INT SC			0...65535 (Decimal)	
09	ACTUAL SIGNALS					
09.01	AI1 SCALED	AI1 SCAL	20000 = 10 V		0...20000	-
09.02	AI2 SCALED	AI2 SCAL	20000 = 20 mA		0...20000	-
09.03	AI3 SCALED	AI3 SCAL	20000 = 20 mA		0...20000	-
09.04	AI5 SCALED	AI5 SCAL	20000 = 20 mA		0...20000	-
09.05	AI6 SCALED	AI6 SCAL	20000 = 20 mA		0...20000	-
09.06	DS MCW	DS MCW	0...65535 (Decimal)		0...65535 (Decimal)	-
09.07	MASTER REF1	M REF1	-32768...32767		-32768...32767	-
09.08	MASTER REF2	M REF2	-32768...32767		-32768...32767	-
09.09	AUX DS VAL1	AUX DSV1	-32768...32767		-32768...32767	-
09.10	AUX DS VAL2	AUX DSV2	-32768...32767		-32768...32767	-
09.11	AUX DS VAL3	AUX DSV3	-32768...32767		-32768...32767	-
09.12	LCU ACT SIGNAL1	LCU ACT1	1 = 1		-	-
09.13	LCU ACT SIGNAL2	LCU ACT2	1 = 1		-	-

1) Percent of motor max. speed / nominal torque / max. process reference (depending on the ACS800 macro selected).

2) The contents of these data words are detailed in chapter [Fieldbus control](#). For the contents of Actual Signal 3.11, see the Master/Follower Application Guide [3AFE64590430 (English)].

Parameters

Index	Name/Selection	FACTORY	HAND/AUTO	PID-CTRL	T-CTRL	SEQ CTRL	PB	W
10	START/STOP/DIR							
10.01	EXT1 STRT/STP/DIR	DI1,2 (US: DI1P,2P,3)	DI1,2	DI1	DI1,2	DI1,2	101	W
10.02	EXT2 STRT/STP/DIR	NOT SEL	DI6,5	DI6	DI1,2	NOT SEL	102	W
10.03	REF DIRECTION	FORWARD	REQUEST	FORWARD	REQUEST	REQUEST	103	W
10.04	EXT 1 STRT PTR	0	0	0	0		104	W
10.05	EXT 2 STRT PTR	0	0	0	0	0	105	W
10.06	JOG SPEED SELECT	NOT SEL	NOT SEL	NOT SEL	NOT SEL	NOT SEL	106	W
10.07	NET CONTROL	0	0	0	0	0	107	
10.08	NET REFERENCE	0	0	0	0	0	108	
10.09	SLS ACTIVE	NO	NO	NO	NO	NO	109	
11	REFERENCE SELECT							
11.01	KEYPAD REF SEL	REF1 (rpm)	REF1 (rpm)	REF1 (rpm)	REF1 (rpm)	REF1 (rpm)	126	
11.02	EXT1/EXT2 SELECT	EXT1	DI3	DI3	DI3	EXT1	127	W
11.03	EXT REF1 SELECT	AI1	AI1	AI1	AI1	AI1	128	W
11.04	EXT REF 1 MINIMUM	0 rpm	0 rpm	0 rpm	0 rpm	0 rpm	129	
11.05	EXT REF 1 MAXIMUM	1500 rpm	1500 rpm	1500 rpm	1500 rpm	1500 rpm	130	
11.06	EXT REF2 SELECT	KEYPAD	AI2	AI1	AI2	AI1	131	W
11.07	EXT REF 2 MINIMUM	0%	0%	0%	0%	0%	132	
11.08	EXT REF 2 MAXIMUM	100%	100%	100%	100%	100%	133	
11.09	EXT 1/2 SEL PTR	0	0	0	0	0	134	
11.10	EXT 1 REF PTR	0	0	0	0	0	135	
11.11	EXT 2 REF PTR	0	0	0	0	0	136	
12	CONSTANT SPEEDS							
12.01	CONST SPEED SEL	DI5,6	DI4(SPEED4)	DI4(SPEED4)	DI4(SPEED4)	DI4,5,6	151	W
12.02	CONST SPEED 1	300 rpm	300 rpm	300 rpm	300 rpm	300 rpm	152	
12.03	CONST SPEED 2	600 rpm	600 rpm	600 rpm	600 rpm	600 rpm	153	
12.04	CONST SPEED 3	900 rpm	900 rpm	900 rpm	900 rpm	900 rpm	154	
12.05	CONST SPEED 4	300 rpm	300 rpm	300 rpm	300 rpm	1200 rpm	155	
12.06	CONST SPEED 5	0 rpm	0 rpm	0 rpm	0 rpm	1500 rpm	156	
12.07	CONST SPEED 6	0 rpm	0 rpm	0 rpm	0 rpm	2400 rpm	157	
12.08	CONST SPEED 7	0 rpm	0 rpm	0 rpm	0 rpm	3000 rpm	158	
12.09	CONST SPEED 8	0 rpm	0 rpm	0 rpm	0 rpm	0 rpm	159	
12.10	CONST SPEED 9	0 rpm	0 rpm	0 rpm	0 rpm	0 rpm	160	
12.11	CONST SPEED 10	0 rpm	0 rpm	0 rpm	0 rpm	0 rpm	161	
12.12	CONST SPEED 11	0 rpm	0 rpm	0 rpm	0 rpm	0 rpm	162	
12.13	CONST SPEED 12	0 rpm	0 rpm	0 rpm	0 rpm	0 rpm	163	
12.14	CONST SPEED 13	0 rpm	0 rpm	0 rpm	0 rpm	0 rpm	164	
12.15	CONST SPEED 14	0 rpm	0 rpm	0 rpm	0 rpm	0 rpm	165	
12.16	CONST SPEED 15	0 rpm	0 rpm	0 rpm	0 rpm	0 rpm	166	
13	ANALOGUE INPUTS							
13.01	MINIMUM AI1	0 V	0 V	0 V	0 V	0 V	176	
13.02	MAXIMUM AI1	10 V	10 V	10 V	10 V	10 V	177	
13.03	SCALE AI1	100%	100%	100%	100%	100%	178	
13.04	FILTER AI1	0.10 s	0.10 s	0.10 s	0.10 s	0.10 s	179	
13.05	INVERT AI1	NO	NO	NO	NO	NO	180	
13.06	MINIMUM AI2	0 mA	0 mA	0 mA	0 mA	0 mA	181	
13.07	MAXIMUM AI2	20 mA	20 mA	20 mA	20 mA	20 mA	182	
13.08	SCALE AI2	100%	100%	100%	100%	100%	183	
13.09	FILTER AI2	0.10 s	0.10 s	0.10 s	0.10 s	0.10 s	184	
13.10	INVERT AI2	NO	NO	NO	NO	NO	185	
13.11	MINIMUM AI3	0 mA	0 mA	0 mA	0 mA	0 mA	186	
13.12	MAXIMUM AI3	20 mA	20 mA	20 mA	20 mA	20 mA	187	
13.13	SCALE AI3	100%	100%	100%	100%	100%	188	
13.14	FILTER AI3	0.10 s	0.10 s	0.10 s	0.10 s	0.10 s	189	
13.15	INVERT AI3	NO	NO	NO	NO	NO	190	

Additional data: actual signals and parameters

Index	Name/Selection	FACTORY	HAND/AUTO	PID-CTRL	T-CTRL	SEQ CTRL	PB	W
13.16	MINIMUM AI5	0 mA	0 mA	0 mA	0 mA	0 mA	191	
13.17	MAXIMUM AI5	20 mA	20 mA	20 mA	20 mA	20 mA	192	
13.18	SCALE AI5	100%	100%	100%	100%	100%	193	
13.19	FILTER AI5	0.10 s	0.10 s	0.10 s	0.10 s	0.10 s	194	
13.20	INVERT AI5	NO	NO	NO	NO	NO	195	
13.21	MINIMUM AI6	0 mA	0 mA	0 mA	0 mA	0 mA	196	
13.22	MAXIMUM AI6	20 mA	20 mA	20 mA	20 mA	20 mA	197	
13.23	SCALE AI6	100%	100%	100%	100%	100%	198	
13.24	FILTER AI6	0.10 s	0.10 s	0.10 s	0.10 s	0.10 s	199	
13.25	INVERT AI6	NO	NO	NO	NO	NO	200	
14	RELAY OUTPUTS							
14.01	RELAY RO1 OUTPUT	READY	READY	READY	READY	READY	201	W
14.02	RELAY RO2 OUTPUT	RUNNING	RUNNING	RUNNING	RUNNING	RUNNING	202	W
14.03	RELAY RO3 OUTPUT	FAULT(-1)	FAULT(-1)	FAULT(-1)	FAULT(-1)	FAULT(-1)	203	W
14.04	RO1 TON DELAY	0.0 s	0.0 s	0.0 s	0.0 s	0.0 s	204	W
14.05	RO1 TOFF DELAY	0.0 s	0.0 s	0.0 s	0.0 s	0.0 s	205	W
14.06	RO2 TON DELAY	0.0 s	0.0 s	0.0 s	0.0 s	0.0 s	206	W
14.07	RO2 TOFF DELAY	0.0 s	0.0 s	0.0 s	0.0 s	0.0 s	207	W
14.08	RO3 TON DELAY	0.0 s	0.0 s	0.0 s	0.0 s	0.0 s	208	W
14.09	RO3 TOFF DELAY	0.0 s	0.0 s	0.0 s	0.0 s	0.0 s	209	W
14.10	DIO MOD1 RO1	READY	READY	READY	READY	READY	210	W
14.11	DIO MOD1 RO2	RUNNING	RUNNING	RUNNING	RUNNING	RUNNING	211	W
14.12	DIO MOD2 RO1	FAULT	FAULT	FAULT	FAULT	FAULT	212	W
14.13	DIO MOD2 RO2	WARNING	WARNING	WARNING	WARNING	WARNING	213	W
14.14	DIO MOD3 RO1	REF 2 SEL	REF 2 SEL	REF 2 SEL	REF 2 SEL	REF 2 SEL	214	W
14.15	DIO MOD3 RO2	AT SPEED	AT SPEED	AT SPEED	AT SPEED	AT SPEED	215	W
14.16	RO PTR1	0	0	0	0	0	216	W
14.17	RO PTR2	0	0	0	0	0	217	W
14.18	RO PTR3	0	0	0	0	0	218	W
14.19	RO PTR4	0	0	0	0	0	219	W
14.20	RO PTR5	0	0	0	0	0	220	W
14.21	RO PTR6	0	0	0	0	0	221	W
14.22	RO PTR7	0	0	0	0	0	222	W
14.23	RO PTR8	0	0	0	0	0	223	W
14.24	RO PTR9	0	0	0	0	0	224	W
15	ANALOGUE OUTPUTS							
15.01	ANALOGUE OUTPUT1	SPEED	SPEED	SPEED	SPEED	SPEED	226	W
15.02	INVERT AO1	NO	NO	NO	NO	NO	227	
15.03	MINIMUM AO1	0 mA	0 mA	0 mA	0 mA	0 mA	228	
15.04	FILTER AO1	0.10 s	0.10 s	0.10 s	0.10 s	0.10 s	229	
15.05	SCALE AO1	100%	100%	100%	100%	100%	230	
15.06	ANALOGUE OUTPUT2	CURRENT	CURRENT	CURRENT	CURRENT	CURRENT	231	W
15.07	INVERT AO2	NO	NO	NO	NO	NO	232	
15.08	MINIMUM AO2	0 mA	0 mA	0 mA	0 mA	0 mA	233	
15.09	FILTER AO2	2.00 s	2.00 s	2.00 s	2.00 s	2.00 s	234	
15.10	SCALE AO2	100%	100%	100%	100%	100%	235	
15.11	AO1 PTR	0	0	0	0	0	236	
15.12	AO2 PTR	0	0	0	0	0	237	
16	SYS CTRL INPUTS							
16.01	RUN ENABLE	YES	YES	DI5	DI6	YES	251	W
16.02	PARAMETER LOCK	OPEN	OPEN	OPEN	OPEN	OPEN	252	
16.03	PASS CODE	0	0	0	0	0	253	
16.04	FAULT RESET SEL	NOT SEL	NOT SEL	NOT SEL	NOT SEL	NOT SEL	254	W
16.05	USER MACRO IO CHG	NOT SEL	NOT SEL	NOT SEL	NOT SEL	NOT SEL	255	W
16.06	LOCAL LOCK	OFF	OFF	OFF	OFF	OFF	256	
16.07	PARAMETER SAVE	DONE	DONE	DONE	DONE	DONE	257	
16.08	RUN ENA PTR	0	0	0	0	0	258	

Index	Name/Selection	FACTORY	HAND/AUTO	PID-CTRL	T-CTRL	SEQ CTRL	PB	W
16.09	CTRL BOARD SUPPLY	INTERNAL 24V	INTERNAL 24V	INTERNAL 24V	INTERNAL 24V	INTERNAL 24V	259	
16.10	ASSIST SEL	ON	ON	ON	ON	ON	260	
16.11	FAULT RESET PTR	0	0	0	0	0	261	
16.12	RESET COUNTER	NO	NO	NO	NO	NO	262	
20	LIMITS							
20.01	MINIMUM SPEED	(calculated)	(calculated)	(calculated)	(calculated)	(calculated)	351	
20.02	MAXIMUM SPEED	(calculated)	(calculated)	(calculated)	(calculated)	(calculated)	352	
20.03	MAXIMUM CURRENT	type specific	type specific	type specific	type specific	type specific	353	
20.04	TORQ MAX LIM1	300%	300%	300%	300%	300%	354	
20.05	OVERVOLTAGE CTRL	ON	ON	ON	ON	ON	355	
20.06	UNDERVOLTAGE CTRL	ON	ON	ON	ON	ON	356	
20.07	MINIMUM FREQ	- 50 Hz	- 50 Hz	- 50 Hz	- 50 Hz	- 50 Hz	357	
20.08	MAXIMUM FREQ	50 Hz	50 Hz	50 Hz	50 Hz	50 Hz	358	
20.11	P MOTORING LIM	300%	300%	300%	300%	300%	361	
20.12	P GENERATING LIM	-300%	-300%	-300%	-300%	-300%	362	
20.13	MIN TORQ SEL	NEG MAX TORQ	NEG MAX TORQ	NEG MAX TORQ	NEG MAX TORQ	NEG MAX TORQ	363	
20.14	MAX TORQ SEL	MAX LIM1	MAX LIM1	MAX LIM1	MAX LIM1	MAX LIM1	364	
20.15	TORQ MIN LIM1	0.0%	0.0%	0.0%	0.0%	0.0%	365	
20.16	TORQ MIN LIM2	0.0%	0.0%	0.0%	0.0%	0.0%	366	
20.17	TORQ MAX LIM2	300.0%	300.0%	300.0%	300.0%	300.0%	367	
20.18	TORQ MIN PTR	0	0	0	0	0	368	
20.19	TORQ MAX PTR	0	0	0	0	0	369	
20.20	MIN AI SCALE	0%	0%	0%	0%	0%	370	
20.21	MAX AI SCALE	300%	300%	300%	300%	300%	371	
20.22	SLS SPEED LIMIT	0 rpm	0 rpm	0 rpm	0 rpm	0 rpm	372	W
21	START/STOP							
21.01	START FUNCTION	AUTO	AUTO	AUTO	AUTO	AUTO	376	W
21.02	CONST MAGN TIME	500.0 ms	500.0 ms	500.0 ms	500.0 ms	500.0 ms	377	W
21.03	STOP FUNCTION	COAST	COAST	COAST	COAST	RAMP	378	
21.04	DC HOLD	NO	NO	NO	NO	NO	379	
21.05	DC HOLD SPEED	5 rpm	5 rpm	5 rpm	5 rpm	5 rpm	380	W
21.06	DC HOLD CURR	30%	30%	30%	30%	30%	381	W
21.07	RUN ENABLE FUNC	COAST STOP	COAST STOP	COAST STOP	COAST STOP	COAST STOP	382	
21.08	SCALAR FLY START	NO	NO	NO	NO	NO	383	
21.09	START INTRL FUNC	OFF2 STOP	OFF2 STOP	OFF2 STOP	OFF2 STOP	OFF2 STOP	384	
21.10	ZERO SPEED DELAY	0.5 s	0.5 s	0.5 s	0.5 s	0.5 s	385	
22	ACCEL/DECEL							
22.01	ACC/DEC SEL	DI4	ACC/DEC 1	ACC/DEC 1	DI5	DI3	401	W
22.02	ACCEL TIME 1	20 s	20 s	20 s	20 s	20 s	402	
22.03	DECEL TIME 1	20 s	20 s	20 s	20 s	20 s	403	
22.04	ACCEL TIME 2	60.00 s	60.00 s	60.00 s	60.00 s	60.00 s	404	
22.05	DECEL TIME 2	60.00 s	60.00 s	60.00 s	60.00 s	60.00 s	405	
22.06	ACC/DEC RAMP SHPE	0.00 s	0.00 s	0.00 s	0.00 s	0.00 s	406	
22.07	EM STOP RAMP TIME	3.00 s	3.00 s	3.00 s	3.00 s	3.00 s	407	
22.08	ACC PTR	0	0	0	0	0	408	
22.09	DEC PTR	0	0	0	0	0	409	
22.10	SLS ACCELER TIME	20 s	20 s	20 s	20 s	20 s	410	W
22.11	SLS DECELER TIME	20 s	20 s	20 s	20 s	20 s	411	W
23	SPEED CTRL							
23.01	GAIN	10	10	10	10	10	426	
23.02	INTEGRATION TIME	2.50 s	2.50 s	2.50 s	2.50 s	2.50 s	427	
23.03	DERIVATION TIME	0.0 ms	0.0 ms	0.0 ms	0.0 ms	0.0 ms	428	
23.04	ACC COMPENSATION	0.00 s	0.00 s	0.00 s	0.00 s	0.12 s	429	
23.05	SLIP GAIN	100.0%	100.0%	100.0%	100.0%	100.0%	430	
23.06	AUTOTUNE RUN	NO	NO	NO	NO	NO	431	
23.07	SP ACT FILT TIME	8 ms	8 ms	8 ms	8 ms	8 ms	432	

Additional data: actual signals and parameters

Index	Name/Selection	FACTORY	HAND/AUTO	PID-CTRL	T-CTRL	SEQ CTRL	PB	W
24	TORQUE CTRL							
24.01	TORQ RAMP UP				0.00 s		451	
24.02	TORQ RAMP DOWN				0.00 s		452	
25	CRITICAL SPEEDS							
25.01	CRIT SPEED SELECT	OFF	OFF	OFF	OFF	OFF	476	
25.02	CRIT SPEED 1 LOW	0 rpm	0 rpm	0 rpm	0 rpm	0 rpm	477	
25.03	CRIT SPEED 1 HIGH	0 rpm	0 rpm	0 rpm	0 rpm	0 rpm	478	
25.04	CRIT SPEED 2 LOW	0 rpm	0 rpm	0 rpm	0 rpm	0 rpm	479	
25.05	CRIT SPEED 2 HIGH	0 rpm	0 rpm	0 rpm	0 rpm	0 rpm	480	
25.06	CRIT SPEED 3 LOW	0 rpm	0 rpm	0 rpm	0 rpm	0 rpm	481	
25.07	CRIT SPEED 3 HIGH	0 rpm	0 rpm	0 rpm	0 rpm	0 rpm	482	
26	MOTOR CONTROL							
26.01	FLUX OPTIMIZATION	NO	NO	NO	NO	NO	501	W
26.02	FLUX BRAKING	YES	YES	YES	YES	YES	502	W
26.03	IR-COMPENSATION	0%	0%	0%	0%	0%	503	W
26.04	IR STEP-UP FREQ	0	0	0	0	0	504	W
26.05	HEX FIELD WEAKEN	NO	NO	NO	NO	NO	505	W
26.06	FLUX REF PTR	C.10000	C.10000	C.10000	C.10000	C.10000	506	W
26.07	FLYSTART CUR REF [%]	60%	60%	60%	60%	60%	507	W
26.08	FLYSTART INIT DLY	25	25	25	25	25	508	W
26.09	FS METHOD	OFF	OFF	OFF	OFF	OFF	509	W
27	BRAKE CHOPPER							
27.01	BRAKE CHOPPER CTL	OFF	OFF	OFF	OFF	OFF	526	W
27.02	BR OVERLOAD FUNC	NO	NO	NO	NO	NO	527	
27.03	BR RESISTANCE						528	
27.04	BR THERM TCONST	0 s	0 s	0 s	0 s	0 s	529	
27.05	MAX CONT BR POWER	0 kW	0 kW	0 kW	0 kW	0 kW	530	
27.06	BC CTRL MODE	COMMON DC	COMMON DC	COMMON DC	COMMON DC	COMMON DC	531	
30	FAULT FUNCTIONS							
30.01	AI<MIN FUNCTION	FAULT	FAULT	FAULT	FAULT	FAULT	601	
30.02	PANEL LOSS	FAULT	FAULT	FAULT	FAULT	FAULT	602	
30.03	EXTERNAL FAULT	NOT SEL	NOT SEL	NOT SEL	NOT SEL	NOT SEL	603	
30.04	MOTOR THERM PROT	NO	NO	NO	NO	NO	604	
30.05	MOT THERM P MODE	DTC/USER MODE	DTC/USER MODE	DTC/USER MODE	DTC/USER MODE	DTC/USER MODE	605	
30.06	MOTOR THERM TIME	(calculated)	(calculated)	(calculated)	(calculated)	(calculated)	606	
30.07	MOTOR LOAD CURVE	100.0%	100.0%	100.0%	100.0%	100.0%	607	
30.08	ZERO SPEED LOAD	74.0%	74.0%	74.0%	74.0%	74.0%	608	
30.09	BREAK POINT	45.0 Hz	45.0 Hz	45.0 Hz	45.0 Hz	45.0 Hz	609	
30.10	STALL FUNCTION	FAULT	FAULT	FAULT	FAULT	FAULT	610	
30.11	STALL FREQ HI	20.0 Hz	20.0 Hz	20.0 Hz	20.0 Hz	20.0 Hz	611	
30.12	STALL TIME	20.00 s	20.00 s	20.00 s	20.00 s	20.00 s	612	
30.13	UNDERLOAD FUNC	NO	NO	NO	NO	NO	613	
30.14	UNDERLOAD TIME	600.0 s	600.0 s	600.0 s	600.0 s	600.0 s	614	
30.15	UNDERLOAD CURVE	1	1	1	1	1	615	
30.16	MOTOR PHASE LOSS	NO	NO	NO	NO	NO	616	
30.17	EARTH FAULT	FAULT	FAULT	FAULT	FAULT	FAULT	617	
30.18	COMM FLT FUNC	FAULT	FAULT	FAULT	FAULT	FAULT	618	
30.19	MAIN REF DS T-OUT	3.00 s	3.00 s	3.00 s	3.00 s	3.00 s	619	
30.20	COMM FLT RO/AO	ZERO	ZERO	ZERO	ZERO	ZERO	620	
30.21	AUX DS T-OUT	3.0 s	3.0 s	3.0 s	3.0 s	3.0 s	621	
30.22	IO CONFIG FUNC	WARNING	WARNING	WARNING	WARNING	WARNING	622	
30.23	LIMIT WARNING	0	0	0	0	0	623	
31	AUTOMATIC RESET							
31.01	NUMBER OF TRIALS	0	0	0	0	0	626	
31.02	TRIAL TIME	30.0 s	30.0 s	30.0 s	30.0 s	30.0 s	627	
31.03	DELAY TIME	0.0 s	0.0 s	0.0 s	0.0 s	0.0 s	628	
31.04	OVERCURRENT	NO	NO	NO	NO	NO	629	



Index	Name/Selection	FACTORY	HAND/AUTO	PID-CTRL	T-CTRL	SEQ CTRL	PB	W
31.05	OVERVOLTAGE	NO	NO	NO	NO	NO	630	
31.06	UNDERVOLTAGE		NO	NO	NO	NO	631	
31.07	AI SIGNAL<MIN	NO	NO	NO	NO	NO	632	
31.08	LINE CONV	NO	NO	NO	NO	NO	633	
32	SUPERVISION							
32.01	SPEED1 FUNCTION	NO	NO	NO	NO	NO	651	
32.02	SPEED1 LIMIT	0 rpm	0 rpm	0 rpm	0 rpm	0 rpm	652	
32.03	SPEED2 FUNCTION	NO	NO	NO	NO	NO	653	
32.04	SPEED2 LIMIT	0 rpm	0 rpm	0 rpm	0 rpm	0 rpm	654	
32.05	CURRENT FUNCTION	NO	NO	NO	NO	NO	655	
32.06	CURRENT LIMIT	0	0	0	0	0	656	
32.07	TORQUE 1 FUNCTION	NO	NO	NO	NO	NO	657	
32.08	TORQUE 1 LIMIT	0%	0%	0%	0%	0%	658	
32.09	TORQUE 2 FUNCTION	NO	NO	NO	NO	NO	659	
32.10	TORQUE 2 LIMIT	0%	0%	0%	0%	0%	660	
32.11	REF1 FUNCTION	NO	NO	NO	NO	NO	661	
32.12	REF1 LIMIT	0 rpm	0 rpm	0 rpm	0 rpm	0 rpm	662	
32.13	REF2 FUNCTION	NO	NO	NO	NO	NO	663	
32.14	REF2 LIMIT	0%	0%	0%	0%	0%	664	
32.15	ACT1 FUNCTION	NO	NO	NO	NO	NO	665	
32.16	ACT1 LIMIT	0%	0%	0%	0%	0%	666	
32.17	ACT2 FUNCTION	NO	NO	NO	NO	NO	667	
32.18	ACT2 LIMIT	0%	0%	0%	0%	0%	668	
33	INFORMATION							
33.01	SOFTWARE VERSION	(Version)	(Version)	(Version)	(Version)	(Version)	676	
33.02	APPL SW VERSION	(Version)	(Version)	(Version)	(Version)	(Version)	677	
33.03	TEST DATE	(Date)	(Date)	(Date)	(Date)	(Date)	678	
33.04	BOARD TYPE	(Control board type)	(Control board type)	(Control board type)	(Control board type)	(Control board type)	679	
34	PROCESS VARIABLE							
34.01	SCALE	100	100	100	100	100	701	
34.02	P VAR UNIT	%	%	%	%	%	702	
34.03	SELECT P VAR	142	142	142	142	142	703	
34.04	MOTOR SP FILT TIM	500 ms	500 ms	500 ms	500 ms	500 ms	704	
34.05	TORQ ACT FILT TIM	100 ms	100 ms	100 ms	100 ms	100 ms	705	
34.06	RESET RUN TIME	NO	NO	NO	NO	NO	706	
35	MOT TEMP MEAS							
35.01	MOT 1 TEMP AI1 SEL	NOT IN USE	NOT IN USE	NOT IN USE	NOT IN USE	NOT IN USE	726	
35.02	MOT 1 TEMP ALM L	110	110	110	110	110	727	
35.03	MOT 1 TEMP FLT L	130	130	130	130	130	728	
35.04	MOT 2 TEMP AI2 SEL	NOT IN USE	NOT IN USE	NOT IN USE	NOT IN USE	NOT IN USE	729	
35.05	MOT 2 TEMP ALM L	110	110	110	110	110	730	
35.06	MOT 2 TEMP FLT L	130	130	130	130	130	731	
35.07	MOT MOD COMPENSAT	YES	YES	YES	YES	YES	732	
35.08	MOT MOD COMP PTR	0	0	0	0	0	733	
40	PID CONTROL							
40.01	PID GAIN	1	1	1	1	1	851	
40.02	PID INTEG TIME	60.00 s	60.00 s	60.00 s	60.00 s	60.00 s	852	
40.03	PID DERIV TIME	0.00 s	0.00 s	0.00 s	0.00 s	0.00 s	853	
40.04	PID DERIV FILTER	1.00 s	1.00 s	1.00 s	1.00 s	1.00 s	854	
40.05	ERROR VALUE INV	NO	NO	NO	NO	NO	855	
40.06	ACTUAL VALUE SEL	ACT1	ACT1	ACT1	ACT1	ACT1	856	
40.07	ACTUAL1 INPUT SEL	AI2	AI2	AI2	AI2	AI2	857	
40.08	ACTUAL2 INPUT SEL	AI2	AI2	AI2	AI2	AI2	858	
40.09	ACT1 MINIMUM	0	0	0	0	0	859	
40.10	ACT1 MAXIMUM	100%	100%	100%	100%	100%	860	
40.11	ACT2 MINIMUM	0%	0%	0%	0%	0%	861	
40.12	ACT2 MAXIMUM	100%	100%	100%	100%	100%	862	

Additional data: actual signals and parameters

Index	Name/Selection	FACTORY	HAND/AUTO	PID-CTRL	T-CTRL	SEQ CTRL	PB	W
40.13	PID INTEGRATION	ON	ON	ON	ON	ON	863	
40.14	TRIM MODE	OFF	OFF		OFF	OFF	864	
40.15	TRIM REF SEL	AI1	AI1		AI1	AI1	865	
40.16	TRIM REFERENCE	0.0%	0.0%	0.0%	0.0%	0.0%	866	
40.17	TRIM RANGE ADJUST	100.0%	100.0%	100.0%	100.0%	100.0%	867	
40.18	TRIM SELECTION				SPEED TRIM		868	
40.19	ACTUAL FILT TIME	0.04 s	0.04 s	0.04 s	0.04 s	0.04 s	869	
40.20	SLEEP SELECTION	not visible	not visible	OFF	not visible	not visible	870	
40.21	SLEEP LEVEL	not visible	not visible	0.0 rpm	not visible	not visible	871	
40.22	SLEEP DELAY	not visible	not visible	0.0 s	not visible	not visible	872	
40.23	WAKE UP LEVEL	not visible	not visible	0%	not visible	not visible	873	
40.24	WAKE UP DELAY	not visible	not visible	0.0 s	not visible	not visible	874	
40.25	ACTUAL1 PTR	0	0	0	0	0	875	
40.26	PID MINIMUM	-100.0%	-100.0%	-100.0%	-100.0%	-100.0%	-	
40.27	PID MAXIMUM	100.0%	100.0%	100.0%	100.0%	100.0%	-	
40.28	TRIM REF PTR	0	0	0	0	0	-	
42	BRAKE CONTROL							
42.01	BRAKE CTRL	OFF	OFF	OFF	OFF	OFF	-	
42.02	BRAKE ACKNOWLEDGE	OFF	OFF	OFF	OFF	OFF	-	
42.03	BRAKE OPEN DELAY	0.0 s	0.0 s	0.0 s	0.0 s	0.0 s	-	
42.04	BRAKE CLOSE DELAY	0.0 s	0.0 s	0.0 s	0.0 s	0.0 s	-	
42.05	ABS BRAKE CLS SPD	10 rpm	10 rpm	10 rpm	10 rpm	10 rpm	-	
42.06	BRAKE FAULT FUNC	FAULT	FAULT	FAULT	FAULT	FAULT	-	
42.07	START TORQ REF SEL	NO	NO	NO	NO	NO	-	
42.08	START TORQ REF	0%	0%	0%	0%	0%	-	
42.09	EXTEND RUN T	0.0 s	0.0 s	0.0 s	0.0 s	0.0 s	-	
42.10	LOW REF BRK HOLD	0.0 s	0.0 s	0.0 s	0.0 s	0.0 s	-	
45	ENERGY OPT							
45.02	ENERGY TARIFF1	0 c/E	0 c/E	0 c/E	0 c/E	0 c/E	-	
45.06	E TARIFF UNIT	EUR	EUR	EUR	EUR	EUR	-	
45.08	PUMP REF POWER	100%	100%	100%	100%	100%	-	
45.09	ENERGY RESET	DONE	DONE	DONE	DONE	DONE	-	
50	ENCODER MODULE							
50.01	PULSE NR	2048	2048	2048	2048	2048	1001	
50.02	SPEED MEAS MODE	A --- B ---	A --- B ---	A --- B ---	A --- B ---	A --- B ---	1002	
50.03	ENCODER FAULT	WARNING	WARNING	WARNING	WARNING	WARNING	1003	
50.04	ENCODER DELAY	1000	1000	1000	1000	1000	1004	
50.05	ENCODER DDCS CH	CHANNEL 1	CHANNEL 1	CHANNEL 1	CHANNEL 1	CHANNEL 1	1005	
50.06	SPEED FB SEL	INTERNAL	INTERNAL	INTERNAL	INTERNAL	INTERNAL	1006	
50.07	ENC CABLE CHECK	NO	NO	NO	NO	NO	1007	
51	COMM MOD DATA						1026	
							...	
52	STANDARD MODBUS							
52.01	STATION NUMBER	1	1	1	1	1	1051	
52.02	BAUDRATE	9600	9600	9600	9600	9600	1052	
52.03	PARITY	ODD	ODD	ODD	ODD	ODD	1053	
60	MASTER/FOLLOWER							
60.01	MASTER LINK MODE	NOT IN USE	NOT IN USE	NOT IN USE	NOT IN USE	NOT IN USE	1195	
60.02	TORQUE SELECTOR	not visible	not visible	not visible	TORQUE	not visible	1196	
60.03	WINDOW SEL ON	not visible	not visible	not visible	NO	not visible	1167	
60.04	WINDOW WIDTH POS	not visible	not visible	not visible	0	not visible	1198	
60.05	WINDOW WIDTH NEG	not visible	not visible	not visible	0	not visible	1199	
60.06	DROOP RATE	0	0	0	0	0	1200	
60.07	MASTER SIGNAL 2	202	202	202	202	202	1201	
60.08	MASTER SIGNAL 3	213	213	213	213	213	1202	
70	DDCS CONTROL							
70.01	CHANNEL 0 ADDR	1	1	1	1	1	1375	
70.02	CHANNEL 3 ADDR	1	1	1	1	1	1376	



Index	Name/Selection	FACTORY	HAND/AUTO	PID-CTRL	T-CTRL	SEQ CTRL	PB	W
70.03	CH1 BAUDRATE	4 Mbit/s	4 Mbit/s	4 Mbit/s	4 Mbit/s	4 Mbit/s	1377	
70.04	CH0 DDCS HW CONN	RING	RING	RING	RING	RING	1378	
70.05	CH2 HW CONNECTION	RING	RING	RING	RING	RING		
72	USER LOAD CURVE							
72.01	OVERLOAD FUNC	NO	NO	NO	NO	NO	1411	
72.02	LOAD CURRENT 1	500	500	500	500	500	1412	
72.03	LOAD CURRENT 2	500	500	500	500	500	1413	
72.04	LOAD CURRENT 3	500	500	500	500	500	1414	
72.05	LOAD CURRENT 4	500	500	500	500	500	1415	
72.06	LOAD CURRENT 5	500	500	500	500	500	1416	
72.07	LOAD CURRENT 6	500	500	500	500	500	1417	
72.08	LOAD CURRENT 7	500	500	500	500	500	1418	
72.09	LOAD CURRENT 8	500	500	500	500	500	1419	
72.10	LOAD FREQ 1	0	0	0	0	0	1420	
72.11	LOAD FREQ 2	0	0	0	0	0	1421	
72.12	LOAD FREQ 3	0	0	0	0	0	1422	
72.13	LOAD FREQ 4	0	0	0	0	0	1423	
72.14	LOAD FREQ 5	0	0	0	0	0	1424	
72.15	LOAD FREQ 6	0	0	0	0	0	1425	
72.16	LOAD FREQ 7	0	0	0	0	0	1426	
72.17	LOAD FREQ 8	0	0	0	0	0	1427	
72.18	LOAD CURRENT LIMIT	800	800	800	800	800	1428	
72.19	LOAD THERMAL TIME	0.0	0.0	0.0	0.0	0.0		
72.20	LOAD COOLING TIME	0	0	0	0	0		
83	ADAPT PROG CTRL							
83.01	ADAPT PROG CMD	EDIT	EDIT	EDIT	EDIT	EDIT	1609	W
83.02	EDIT COMMAND	NO	NO	NO	NO	NO	1610	
83.03	EDIT BLOCK	0	0	0	0	0	1611	
83.04	TIMELEVEL SEL	100ms	100ms	100ms	100ms	100ms	1612	
83.05	PASSCODE	0	0	0	0	0	1613	
84	ADAPTIVE PROGRAM							
84.01	STATUS						1628	
84.02	FAULTED PAR						1629	
84.05	BLOCK1	NO	NO	NO	NO	NO	1630	
84.06	INPUT1	0	0	0	0	0	1631	
84.07	INPUT2	0	0	0	0	0	1632	
84.08	INPUT3	0	0	0	0	0	1633	
84.09	OUTPUT	0	0	0	0	0	1634	
...	
84.79	OUTPUT	0	0	0	0	0	-	
85	USER CONSTANTS							
85.01	CONSTANT1	0	0	0	0	0	1645	
85.02	CONSTANT2	0	0	0	0	0	1646	
85.03	CONSTANT3	0	0	0	0	0	1647	
85.04	CONSTANT4	0	0	0	0	0	1648	
85.05	CONSTANT5	0	0	0	0	0	1649	
85.06	CONSTANT6	0	0	0	0	0	1650	
85.07	CONSTANT7	0	0	0	0	0	1651	
85.08	CONSTANT8	0	0	0	0	0	1652	
85.09	CONSTANT9	0	0	0	0	0	1653	
85.10	CONSTANT10	0	0	0	0	0	1654	
85.11	STRING1	MESSAGE1	MESSAGE1	MESSAGE1	MESSAGE1	MESSAGE1	1655	
85.12	STRING2	MESSAGE2	MESSAGE2	MESSAGE2	MESSAGE2	MESSAGE2	1656	
85.13	STRING3	MESSAGE3	MESSAGE3	MESSAGE3	MESSAGE3	MESSAGE3	1657	
85.14	STRING4	MESSAGE4	MESSAGE4	MESSAGE4	MESSAGE4	MESSAGE4	1658	
85.15	STRING5	MESSAGE5	MESSAGE5	MESSAGE5	MESSAGE5	MESSAGE5	1659	

Additional data: actual signals and parameters

Index	Name/Selection	FACTORY	HAND/AUTO	PID-CTRL	T-CTRL	SEQ CTRL	PB	W	
90	D SET REC ADDR								
90.01	AUX DS REF3	0	0	0	0	0	1735		
90.02	AUX DS REF4	0	0	0	0	0	1736		
90.03	AUX DS REF5	0	0	0	0	0	1737		
90.04	MAIN DS SOURCE	1	1	1	1	1	1738		
90.05	AUX DS SOURCE	3	3	3	3	3	1739		
92	D SET TR ADDR								
92.01	MAIN DS STATUS WORD	302	302	302	302	302	1771		
92.02	MAIN DS ACT1	102	102	102	102	102	1772		
92.03	MAIN DS ACT2	105	105	105	105	105	1773		
92.04	AUX DS ACT3	305	305	305	305	305	1774		
92.05	AUX DS ACT4	308	308	308	308	308	1775		
92.06	AUX DS ACT5	306	306	306	306	306	1776		
92.07	MSW B10 PTR	3.014.09	3.014.09	3.014.09	3.014.09	3.014.09	1777		
92.08	MSW B13 PTR	0	0	0	0	0	1778		
92.09	MSW B14 PTR	0	0	0	0	0	1779		
95	HARDWARE SPECIF								
95.01	FAN SPD CTRL MODE	CONTROLLED						1825	
95.02	FUSE SWITCH CTRL	Inverter type dependent						1826	
95.03	INT CONFIG USER	0	0	0	0	0	1827		
95.04	EX/SIN REQUEST	1	1	1	1	1	1828		
95.05	ENA INC SW FREQ	0	0	0	0	0	1829		
95.06	LCU Q PW REF	0	0	0	0	0	1830		
95.07	LCU DC REF	0	0	0	0	0	1831		
95.08	LCU PAR1 SEL	106	106	106	106	106	1832		
95.09	LCU PAR2 SEL	110	110	110	110	110	1833		
95.10	TEMP INV AMBIENT	40°C	40°C	40°C	40°C	40°C	1834		
95.11	SUPPLY CTRL MODE	type specific	type specific	type specific	type specific	type specific	1835		
95.12	LCU RUN PTR	C.00000	C.00000	C.00000	C.00000	C.00000	1836		
96	EXTERNAL AO								
96.01	EXT AO1	SPEED	SPEED	SPEED	SPEED	SPEED	1843		
96.02	INVERT EXT AO1	NO	NO	NO	NO	NO	1844		
96.03	MINIMUM EXT AO1	0 mA	0 mA	0 mA	0 mA	0 mA	1845		
96.04	FILTER EXT AO1	0.01 s	0.01 s	0.01 s	0.01 s	0.01 s	1846		
96.05	SCALE EXT AO1	100%	100%	100%	100%	100%	1847		
96.06	EXT AO2	CURRENT	CURRENT	CURRENT	CURRENT	CURRENT	1848		
96.07	INVERT EXT AO2	NO	NO	NO	NO	NO	1849		
96.08	MINIMUM EXT AO2	0 mA	0 mA	0 mA	0 mA	0 mA	1850		
96.09	FILTER EXT AO2	2.00 s	2.00 s	2.00 s	2.00 s	2.00 s	1851		
96.10	SCALE EXT AO2	100%	100%	100%	100%	100%	1852		
96.11	EXT AO1 PTR	0	0	0	0	0	1853		
96.12	EXT AO2 PTR	0	0	0	0	0	1854		
98	OPTION MODULES								
98.01	ENCODER MODULE	NO	NO	NO	NO	NO	1901		
98.02	COMM. MODULE LINK	NO	NO	NO	NO	NO	1902		
98.03	DI/O EXT MODULE 1	NO	NO	NO	NO	NO	1903		
98.04	DI/O EXT MODULE 2	NO	NO	NO	NO	NO	1904		
98.05	DI/O EXT MODULE 3	NO	NO	NO	NO	NO	1905		
98.06	AI/O EXT MODULE	NO	NO	NO	NO	NO	1906		
98.07	COMM PROFILE	ABB DRIVES	ABB DRIVES	ABB DRIVES	ABB DRIVES	ABB DRIVES	1907		
98.09	DI/O EXT1 DI FUNC	DI7,8,9	DI7,8,9	DI7,8,9	DI7,8,9	DI7,8,9	1909		
98.10	DI/O EXT2 DI FUNC	DI10,11,12	DI10,11,12	DI10,11,12	DI10,11,12	DI10,11,12	1910		
98.11	DI/O EXT3 DI FUNC	DI11,12	DI11,12	DI11,12	DI11,12	DI11,12	1911		
98.12	AI/O MOTOR TEMP	NO	NO	NO	NO	NO	1912		
98.13	AI/O EXT AI1 FUNC	UNIPOLAR AI5	UNIPOLAR AI5	UNIPOLAR AI5	UNIPOLAR AI5	UNIPOLAR AI5	1913		
98.14	AI/O EXT AI2 FUNC	UNIPOLAR AI6	UNIPOLAR AI6	UNIPOLAR AI6	UNIPOLAR AI6	UNIPOLAR AI6	1914		



Index	Name/Selection	FACTORY	HAND/AUTO	PID-CTRL	T-CTRL	SEQ CTRL	PB	W
98.16	SIN FILT SUPERV	NO	NO	NO	NO	NO	1915	
99	START-UP DATA							
99.01	LANGUAGE	ENGLISH	ENGLISH	ENGLISH	ENGLISH	ENGLISH	1926	
99.02	APPLICATION MACRO	FACTORY	HAND/AUTO	PID-CTRL	T CTRL	SEQ CTRL	1927	W
99.03	APPLIC RESTORE	NO	NO	NO	NO	NO	1928	W
99.04	MOTOR CTRL MODE	DTC	DTC	DTC	DTC	DTC	1929	
99.05	MOTOR NOM VOLTAGE	0 V	0 V	0 V	0 V	0 V	1930	W
99.06	MOTOR NOM CURRENT	0.0 A	0.0 A	0.0 A	0.0 A	0.0 A	1931	W
99.07	MOTOR NOM FREQ	50.0 Hz	50.0 Hz	50.0 Hz	50.0 Hz	50.0 Hz	1932	W
99.08	MOTOR NOM SPEED	2900 rpm	2900 rpm	2900 rpm	2900 rpm	2900 rpm	1933	W
99.09	MOTOR NOM POWER	0.0 kW	0.0 kW	0.0 kW	0.0 kW	0.0 kW	1934	W
99.10	MOTOR ID RUN MODE	ID MAGN	ID MAGN	ID MAGN	ID MAGN	ID MAGN	1935	W
99.11	DEVICE NAME						1936	

Control block diagrams

Chapter overview

Diagram	Related diagrams
<i>Reference control chain, sheet 1</i> Valid when FACTORY, HAND/AUTO, SEQ CTRL or T CTRL macro is active (see parameter 99.02).	Continued on sheet 2
<i>Reference control chain, sheet 1</i> Valid when PID CTRL macro is active (see parameter 99.02).	Continued on sheet 2
<i>Reference control chain, sheet 2</i> Valid with all macros (see parameter 99.02).	Continued from sheet 1
<i>Handling of Start, Stop, Run Enable Start Interlock</i> Valid with all macros (see parameter 99.02).	-
<i>Handling of Reset and On/Off</i> Valid with all macros (see parameter 99.02).	-

Reference control chain, sheet 1: FACTORY, HAND/AUTO, SEQ CTRL and T CTRL macros (continued on the next page ...)

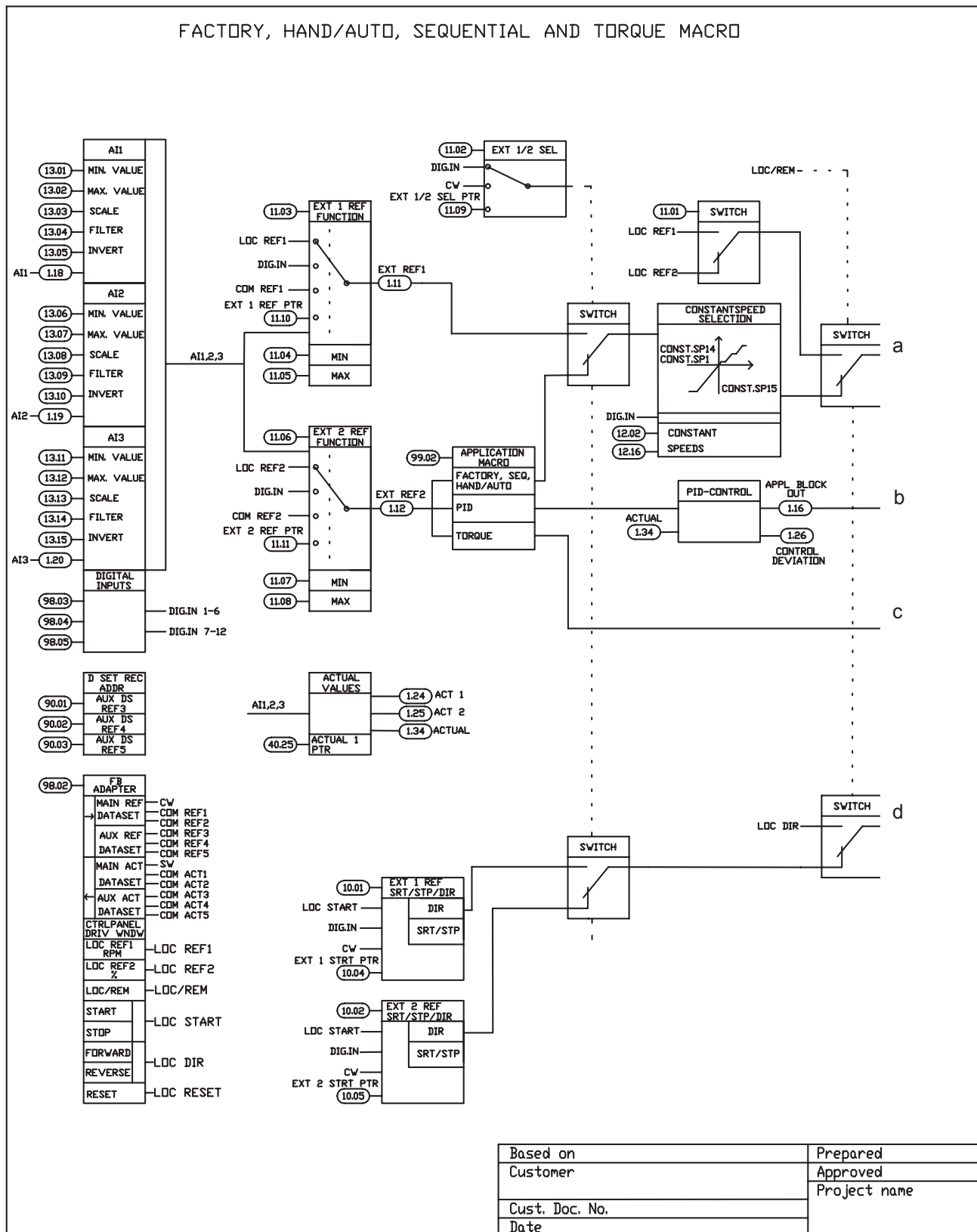

... continued from the previous page

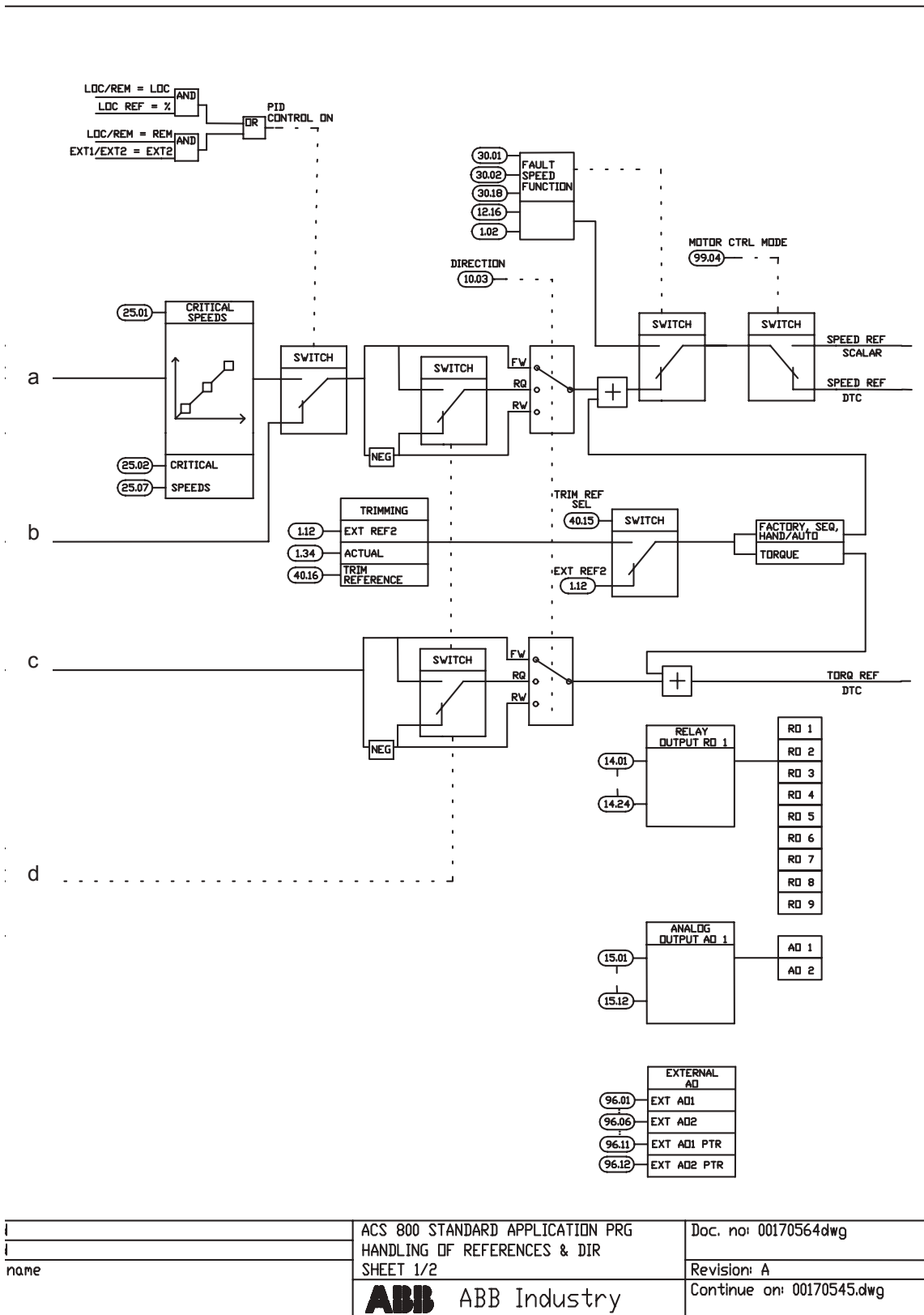

name	ACS 800 STANDARD APPLICATION PRG	Doc. no: 00170564dwg
	HANDLING OF REFERENCES & DIR	Revision: A
	SHEET 1/2	Continue on: 00170545.dwg
ABB ABB Industry		

Reference control chain sheet 1: PID CTRL macro (continued on the next page ...)

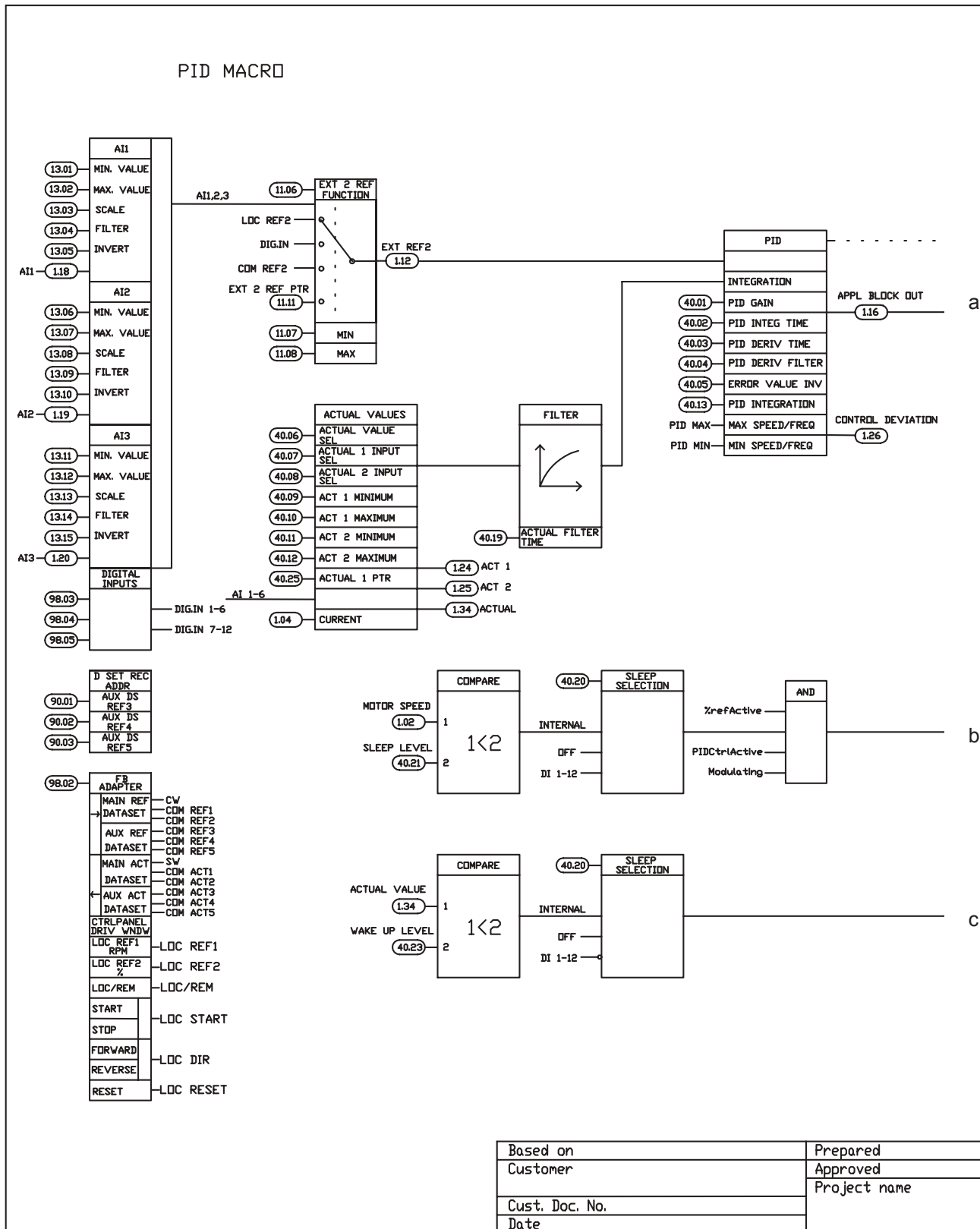

... continued from the previous page

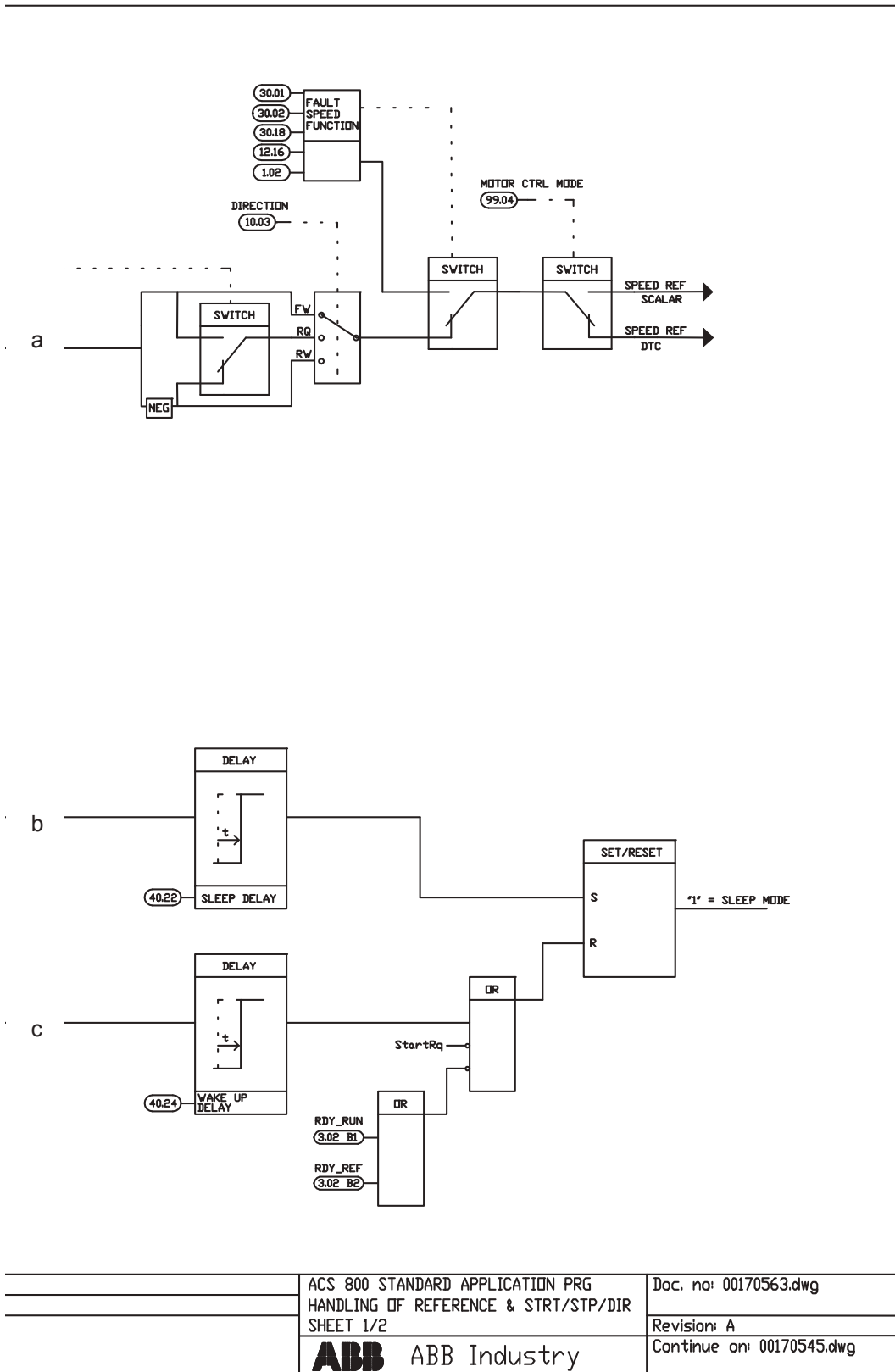

	ACS 800 STANDARD APPLICATION PRG	Doc. no: 00170563.dwg
	HANDLING OF REFERENCE & STRT/STP/DIR	Revision: A
	SHEET 1/2	Continue on: 00170545.dwg
	ABB ABB Industry	

Reference control chain sheet 2: All macros (continued on the next page ...)

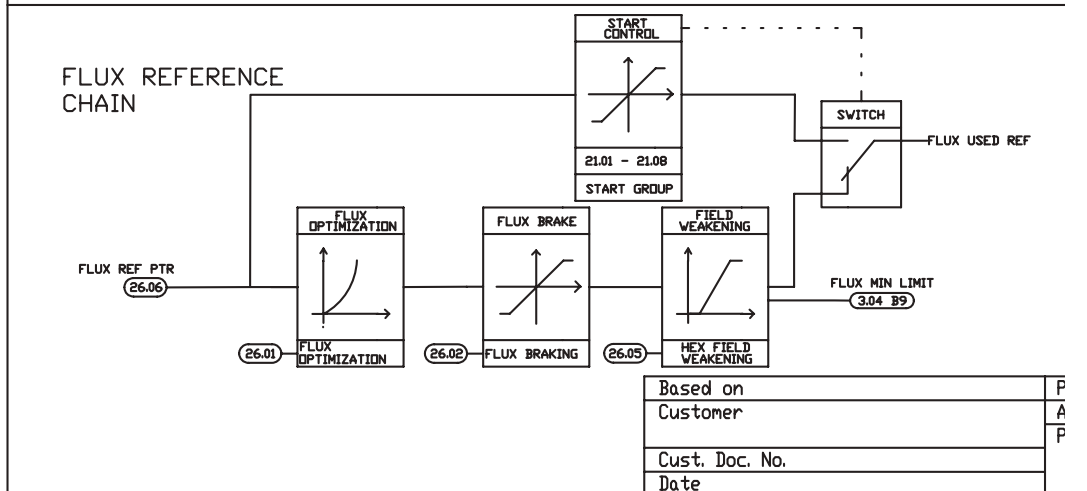
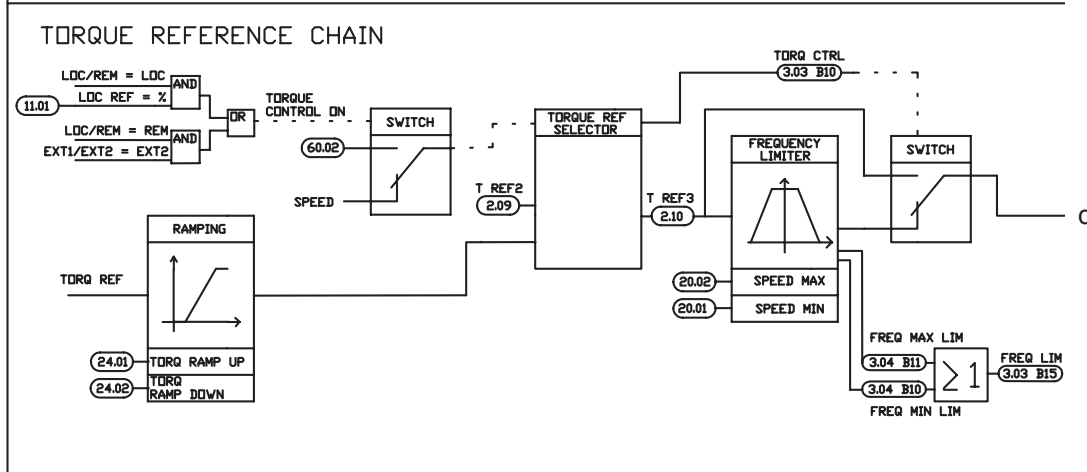
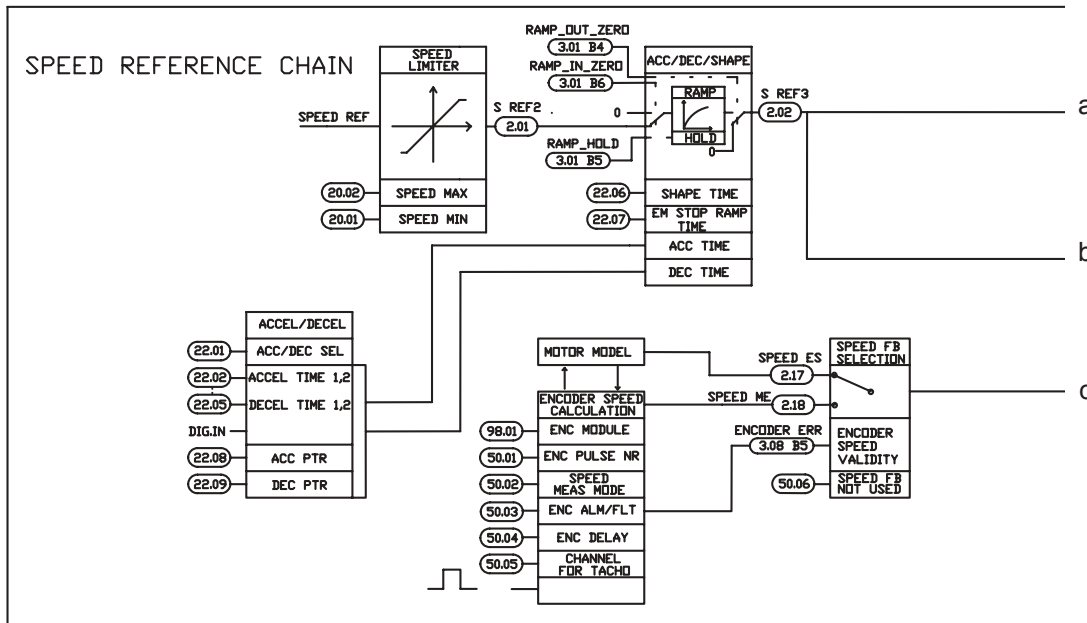

... continued from the previous page

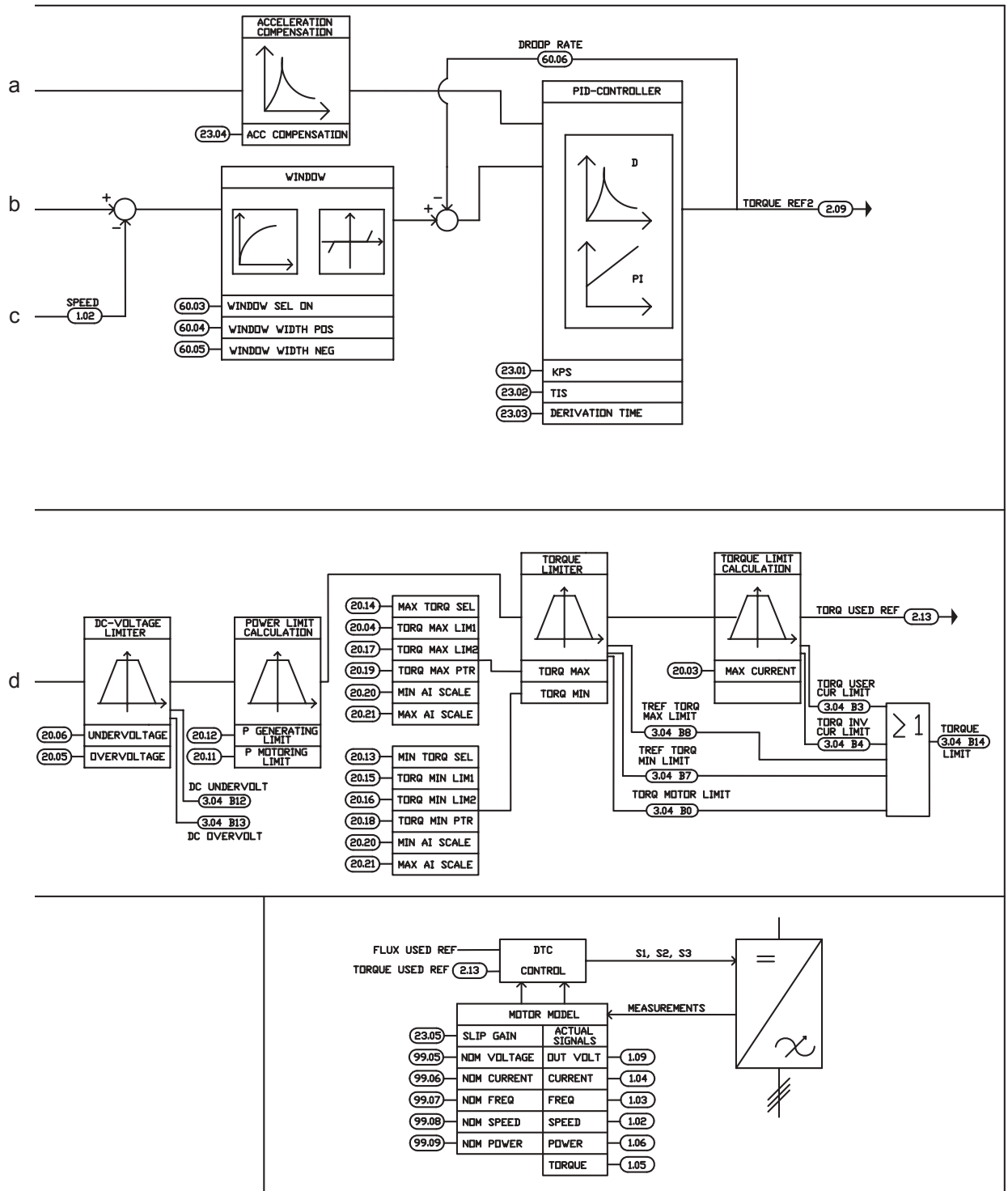

repared	ACS 800 STANDARD APPLICATION PRG	Doc. no: 00170545.dwg
pproved	HANDLING OF REFERENCES	Revision: A
roject name	SHEET 2/2	Continue on: -
ABB ABB Industry		

Handling of Start, Stop, Run Enable and Start Interlock

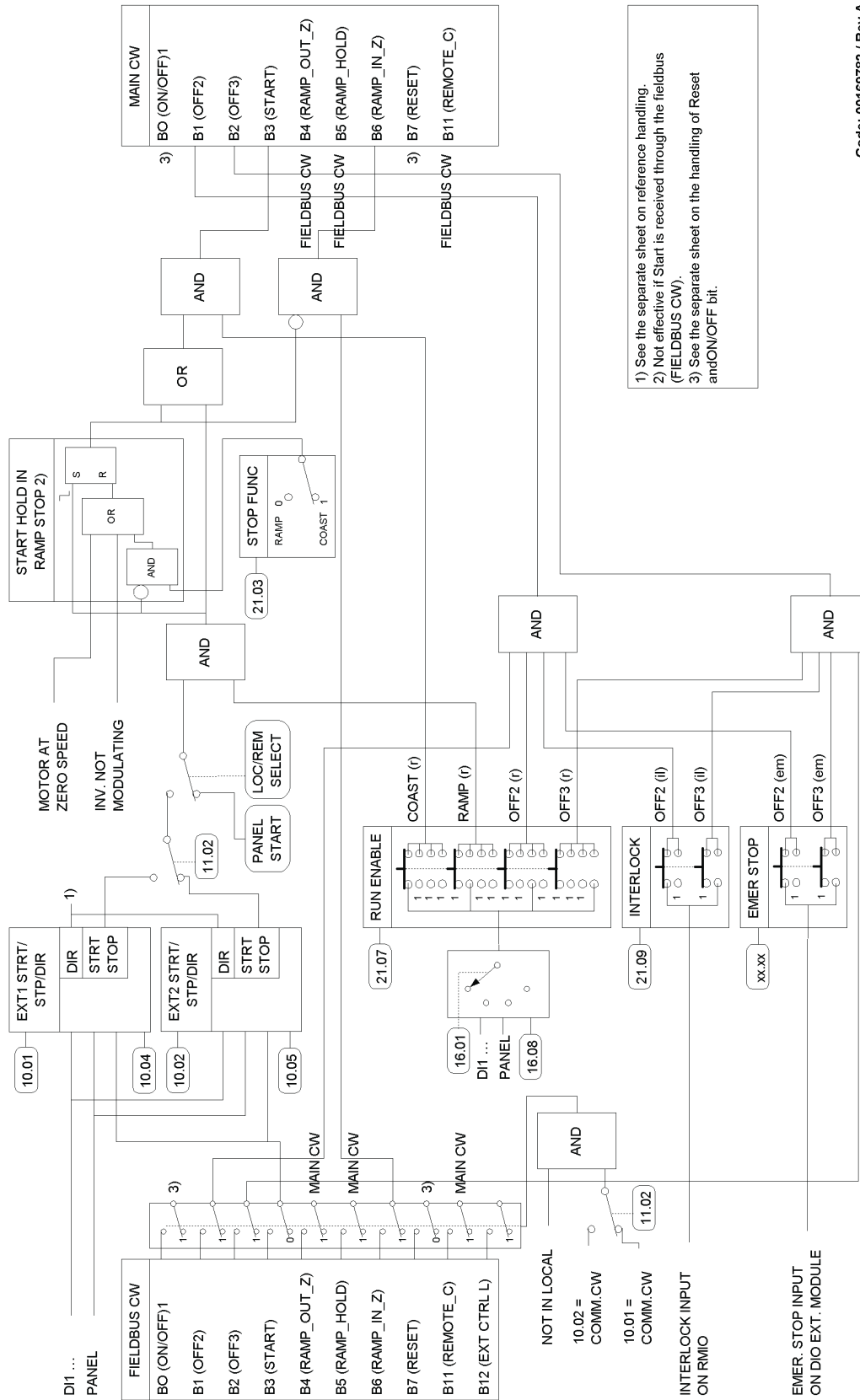

Code: 00169783 / Rev A

Handling of Reset and On/Off

The diagram below is a detail to the previous diagram (*Handling of Start, Stop, Run Enable and Start Interlock*).

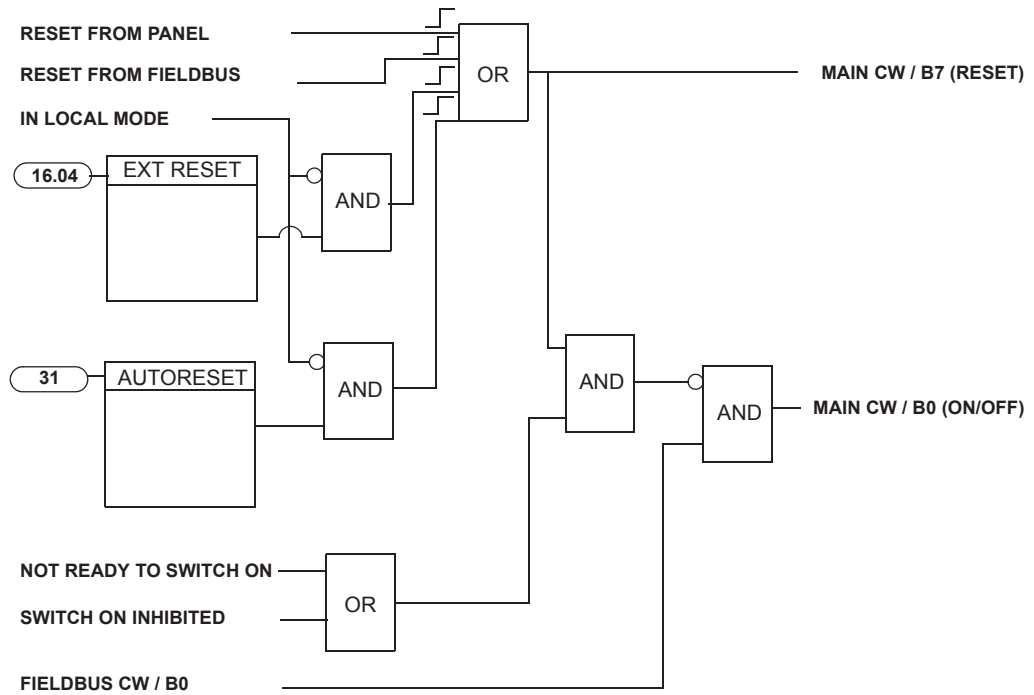

Index

A

ABB drives communication profile 210
 Absolute maximum frequency 99, 253
 Absolute maximum speed 99, 253
 ACCEL TIME 1 136
 ACCEL/DECEL 135
 Acceleration
 compensation 139
 motor 102
 ramps 59
 settings 59
 speed reference ramps 46
 times 20
 times, setting 42
 Actual signals 53, 255–257
 defined 99
 diagnostics 44, 52, 53
 display mode 29
 displaying the full names 30
 parameters 52, 53
 PID control 71
 settings 52, 53
 speed controller 60
 speed controller tuning 60
 user-defined variables 69
 Actual values 53
 actual signals 52, 53
 analogue outputs 50
 defined 205
 digital inputs 51
 relay outputs 52
 Adapter module, fieldbus 192
 Advent controller 197–198
 AI 63
 ALARM WORD 1 222
 ALARM WORD 2 223
 ALARM WORD 4 225
 ALARM WORD 5 226
 ALARM WORD 6 227
 Analogue extension module 249
 Analogue inputs
 optional, supervising 66
 Analogue outputs
 diagnostics 50
 optional, supervising 66
 parameters 50
 settings 50
 APPLICATION MACRO 101, 187

Application macros 85
 factory 85, 87
 hand/auto 85, 89
 PID control 85, 91
 reference control chain diagram 270
 sequential control 85, 95
 torque control 85, 93
 user 85, 97
 Application, selection for start-up assistant 41
 Automatic resets 69
 Automatic start 54
 AUXILIARY STATUS WORD 3 223
 AUXILIARY STATUS WORD 4 224

B

Boolean values 40

C

Cable connection, monitoring 65
 Clearing
 fault history 30
 Communication
 fault protection 66
 profiles 210–218
 using a fieldbus adapter module 193
 Communication profiles 210–218
 ABB drives 210
 generic drive 215
 Constant speeds 59
 Control block diagrams 267–275
 Control board temperature fault 68
 Control panel
 basic keys 35
 display mode 29
 downloading drive data 37
 drive control 27–28
 overview 25–26
 setting the display contrast 38
 upload drive data 36
 Control word 203
 CSA 2.8/3.0 communication profile 218
 Critical speeds 59

D

DC
 hold 57

- intermediate circuit protection 69
 - magnetising 57
 - overvoltage fault 66
 - undervoltage fault 67
 - DECEL TIME 1 136
 - Deceleration
 - compensation 139
 - ramps 59
 - settings 59
 - Default tasks, start-up assistant 41
 - Diagnostics
 - actual signals 44, 52, 53
 - analogue outputs 50
 - digital inputs 51
 - relay outputs 52
 - speed controller 60
 - supervision of user-defined variables 69
 - Digital inputs
 - diagnostics 51
 - optional, supervising 66
 - parameters 51
 - settings 51
 - Digital outputs
 - optional, supervising 66
 - Display contrast, setting 38
 - Displaying
 - actual signal full names 30
 - fault history 30
 - Drive
 - changing panel link ID number 39
 - data, downloading to the control panel 37
 - data, uploading to the control panel 36
 - IR compensation for scalar controlled 62
 - reference types and processing 46
 - start-up 15
 - temperature fault 67
 - Drive control
 - parameters 199–201
 - using I/O interface 21
- E**
- Earth fault protection 65
 - Energy optimizing 101, 164
 - EXT IO STATUS 228
 - External control 44
 - diagnostics 44
 - reference source diagram 45
 - stop, start, direction diagram 45
 - External fault 63
- F**
- Factory macros 85–87
- Fault history
 - clearing 30
 - viewing and resetting 30
 - FAULT WORD 1 220
 - FAULT WORD 2 221
 - FAULT WORD 4 224
 - FAULT WORD 5 225
 - FAULT WORD 6 228
 - FAULTED INT INFO 229
 - Faults
 - communication, protection 66
 - DC overvoltage 66
 - earth, protection 65
 - external, settings 63
 - overcurrent 66
 - preprogrammed 66
 - control board temperature 68
 - DC undervoltage 67
 - drive temperature 67
 - Enhanced drive temperature monitoring 67
 - input phase loss 68
 - internal fault 68
 - overfrequency 68
 - short circuit 68
 - Features of the program 41–84
 - Fieldbus adapter
 - communication parameters 193–194
 - module 192
 - Fieldbus addresses 253
 - Fieldbus control 191–230
 - connecting two fieldbuses to a drive 192
 - control word, status word 203
 - interface 202–209
 - References 203
 - Fieldbus reference scaling
 - ABB drives communication profile 214
 - CSA 2.8/3.0 communication profile 218
 - generic drive 217
 - Fieldbus, equivalent, defined 99
 - Flux braking 57, 58
 - Flux optimisation 58
- G**
- Generic drive communication profile 215
- H**
- Hand/auto macro 85, 89
 - Hexagonal motor flux 63
- I**
- ID run procedure 22–23
 - Input bridge protection 69

Input phase loss fault 68
 INT INIT FAULT 226
 INT SC INFO 230
 Integer scaling 67
 Internal fault 68

K

Keys on the control panel 35

L

LIMIT WORD 1 220
 LIMIT WORD INV 227
 Limits, adjustable 68
 Local control 44

M

Macros

factory 85, 87
 hand/auto 85, 89
 overview 85
 PID control 85, 91
 reference control chain diagram 270
 sequential control 95
 defined 85
 torque control 85, 93
 user 97
 defined 85

Modbus

adapter module 192
 addressing 196
 link, communication parameters 195–196

Motor

identification 53
 phase loss 65
 stall protection 65
 temperature measurement using standard I/O
 72, 73
 temperature thermal model 64
 thermal protection 64
 underload protection 65

O

Operation limits 68
 Overcurrent fault 66
 Overfrequency fault 68

P

Panel link ID number, changing 39
 Panel loss 63
 Parameter lock 69

Parameter settings, bipolar input in joystick mode
 251

Parameters

actual signals 52, 53
 Advent controller 197–198
 AI 63
 analogue outputs 50
 automatic reset 69
 communication fault protection 66
 data tables 258
 defined 99
 digital inputs 51
 drive control 199–201
 earth fault protection 65
 external fault 63
 fieldbus adapter 193–194
 hexagonal motor flux 63
 IR compensation 62
 motor phase loss 65
 motor stall protection 65
 motor temperature 64
 motor underload protection 65
 operation limits 68
 optional analogue inputs and outputs 66
 parameter lock 69
 reference trimming 47
 relay outputs 52
 scalar control 62
 selecting and changing values 32
 speed controller tuning 60
 standard modbus link 195–196
 start-up assistant 41
 supervision 69

PB, defined 253

Performance figures

speed controller 60
 torque control 60

PID control

block diagrams 70
 macro 85, 91
 macro, reference control diagram 270
 parameters 71
 settings 71
 sleep function 71

Power limit 69

Power loss ride-through 54

Preprogrammed faults 66

control board temperature 68
 DC undervoltage 67
 drive temperature 67
 Enhanced drive temperature monitoring 67
 input phase loss 68
 internal fault 68
 overfrequency 68

short circuit 68
Prevention of unexpected start-up (POUS) 55
Program features 41–84
Programmable
 analogue outputs 50
 digital inputs 51
 relay outputs 52
Protection functions 63

R

Ramps
 acceleration 59
 deceleration 59
Reference
 control chain diagrams 270
 handling 204
 source
 EXT 1 45
 types and processing 46
 trimming 47
Relay outputs
 diagnostics 52
 parameters 52
 settings 52
Resets, automatic 69
Resetting
 fault history 30

S

Safe torque off (STO) 55
Safely-limited speed (SLS) 56
Scalar control 62
Sequential control macro 95
 defined 85
Setting, acceleration times 42
Settings
 acceleration 59
 actual signals 52, 53
 AI 63
 analogue outputs 50
 automatic reset 69
 automatic start 54
 communication fault protection 66
 constant speed 59
 critical speeds 59
 DC hold 57
 DC magnetising 57
 deceleration 59
 digital inputs 51
 earth fault protection 65
 external control 44
 external fault 63

flux braking 58
flux optimisation 58
hexagonal motor flux 63
IR compensation 62
limits 68
local control 44
motor phase loss 65
motor stall protection 65
motor temperature 64
motor underload protection 65
optional analogue inputs 66
optional analogue outputs 66
optional digital inputs 66
optional digital outputs 66
parameter lock 69
PID control 71
reference trimming 47
relay outputs 52
scalar control 62
speed controller 60
supervision 69
Short circuit fault 68
Sleep function 71
 example 72
Speed controller tuning 60
Speed reference
 acceleration/deceleration ramps 46
 parameters 250
Stall protection 65
Start-up 15
 automatic start 54
 basic settings 17–20
 guided 15–16
Start-up assistant
 application selection 41
 default tasks 41
 tasks and parameters 41
Status word 203
 auxiliary 219
 CSA 2.8/3.0 communication profile 218
Supervising user-selectable variables 69
SYSTEM FAULT WORD 222
System overview 191

T

Temperature
 calculation method 64
 measurement using standard I/O 72, 73
Torque control
 macro 85, 93
 performance figures 60
Tuning the speed controller 60



U

- Underload protection 65
- User macros 97
 - defined 85
- user-defined, supervising 69

V

- Variables 69
- Viewing fault history 30

www.nicsanat.com

021-87700210



ABB

3AFE64527592 REV L / EN
EFFECTIVE: 2011-08-25

ABB Oy

Drives
P.O. Box 184
FI-00381 HELSINKI
FINLAND
Telephone +358 10 22 211
Telefax +358 10 22 22681
Internet www.abb.com/drives

ABB Inc.

Automation Technologies
Drives & Motors
16250 West Glendale Drive
New Berlin, WI 53151
USA
Telephone 262 785-3200
1-800-HELP-365
Fax 262 780-5135

ABB Beijing Drive Systems Co. Ltd.

No. 1, Block D, A-10 Jiuxianqiao Beilu
Chaoyang District
Beijing, P.R. China, 100015
Telephone +86 10 5821 7788
Fax +86 10 5821 7618
Internet www.abb.com/drives