



NVF2G-S Series Inverter

www.nicsanat.com

021-87700210



Standard: EC 618 02

www.nicsanat.com

021-87700210

NIC SANAT

نیک صنعت



Foreword

NVF2G-S series vector control inverter produced by Zhejiang Chint Electric Co., Ltd. !

NVF2G-S series inverters have V/F control and speed sensorless vector control technology, which not only has high speed response and good low-frequency torque performance, but also has the characteristics of convenient parameter debugging and simple and easy-to-use functions. At the same time, the reliability and environmental adaptability have been strengthened, which can meet the applications of fans, water pumps, mines, air compressors, HVAC and so on.

This manual introduces the functional characteristics and usage methods of NVF2G-S series inverters, including product selection, installation and commissioning, parameter function description, etc. Please read this manual carefully before using the inverter to ensure correct use of the inverter. After reading and using this manual, please keep it properly for future use. If you encounter difficulties and problems that cannot be solved during use, please contact the company's local distributors or directly contact the company's professional and technical personnel for help. (400 customer service hotline: 400-817-7777)

The company reserves the right to continuously optimize and improve the NVF2G-S series inverters, and the information is subject to change without prior notice.

Safety Alert

- 1 The product is strictly prohibited to be installed in an environment containing flammable and explosive gas, moisture condensation, and it is strictly prohibited to operate the product with wet hands.
- 2 When the product is working, it is strictly forbidden to touch the conductive part of the product.
- 3 When installing, maintaining and maintaining the product, it is necessary to ensure that the line is powered off.
- 4 It is strictly forbidden for children to play with the unpacked product or packaging.
- 5 Sufficient space and safety distance should be reserved around the product installation.
- 6 Do not install it where the gas medium can corrode metal and damage insulation.
- 7 When the product is installed and used, standard wires must be used, and the power supply and load that meet the requirements must be connected.
- 8 In order to avoid dangerous accidents, the installation and fixing of the product must be carried out in strict accordance with the requirements of the manual.
- 9 After unpacking, inspect the product for damage and check the integrity of the item.
- 10 When installing live wires outside the product, in order to prevent electric shock, please insulate the exposed wires.
- 11 If the inverter is damaged or its components are incomplete, please do not install and run it, otherwise there is a risk of fire and injury.
- 12 Do not install in places where water droplets may splash, such as direct sunlight or water pipes, otherwise there is a risk of damage to the equipment;
- 13 Do not short-circuit + and B. It is strictly forbidden to connect terminals other than R1A, R1B, R1C, R2A, R2B, and R2C to AC 220V signals, otherwise there is a risk of damage to the equipment.
- 14 When transporting, do not let the operation panel and cover plate be stressed, otherwise there is a risk of damage to the equipment and injury when falling.
- 15 Please install it in a place that can bear the weight of the inverter, otherwise there is a risk of damage to the equipment and injury when it falls.
- 16 Before leaving the factory, all inverters have been tested for withstand voltage, and it is forbidden to conduct withstand voltage tests for inverters, otherwise there is a risk of damage to the equipment.
- 17 When the length of the motor cable is greater than 100 meters, multi-twisted wires must be used and an AC output reactor that can suppress high-frequency oscillation must be installed. Avoid motor insulation damage, excessive leakage current and frequent inverter protection.
- 18 After replacing the control board, the parameters must be set correctly before running, otherwise there is a risk of damage to the equipment.

Safety Alert

- 19 It is forbidden for non-professional technicians to test the signal during operation , otherwise there is a risk of injury or equipment damage.
- 20 It is not allowed to control the start and stop of the inverter by frequently turning on and off the power, otherwise there is a risk of damage to the equipment.
- 21 In a domestic environment this product may cause radio interference, in which case additional suppression measures (chokes, filters, etc.) may be required.
- 22 The electrolytic capacitor of the main circuit and the electrolytic capacitor on the printed circuit board may explode when incinerated, and the panel and other plastic parts will produce toxic gas when incinerated. Please dispose of it as industrial waste.





logo	illustrate
 	Danger! Please be sure to read the user manual before installation and operation.
  10min	Danger! Do not remove the upper cover when the power is on or within 10 minutes after the power is cut off.

Table of contents

PREFACE	000
SECURITY ALERT	000
1 Main purpose and scope of application	001
1.1 Unpacking inspection	001
1.2 Main purpose	001
1.3 Scope of application	001
1.4 Series model specifications and their meanings	001
1.5 Product specifications and models	002
2 Normal use, installation, transportation and storage conditions	003
2.1 Use, transportation and storage conditions	003
2.2 Installation conditions	003
3 Main technical parameters and performance	006
3.1 Technical parameters and performance	006
4 Structural features and working principle	007
4.1 Product Structure Features Figure	007
4.2 Main circuit terminal description	009
4.3 Description of Control Circuit Terminals	012
4.4 Instructions for use of control terminals	015
5 Product appearance and installation dimensions	018
5.1 Product appearance and weight	018
5.2 Dimensions of display box and pallet	020

Table of contents

6	Installation and Wiring	021
6.1	Installation Notes	021
6.2	Precautions for use	022
6.3	EMC Precautions	023
6.4	Power on for the first time	024
7	Operation and debugging	025
7.1	Operation panel introduction	025
7.2	Example of panel operation	027
7.3	Common parameters	032
8	Detailed Explanation of Basic Function Parameters	035
8.1	Running command setting	035
8.2	Frequency command setting	037
8.3	Start and stop method setting	046
8.4	Motor parameter self-learning	049
8.5	V/F Control Parameters	050
8.6	Vector control	052
8.7	Overflow stall protection	052
8.8	Overvoltage stall suppression	053
8.9	Protective functions	053
8.10	Monitoring functions	056
8.11	Terminal function setting	057

Table of contents

8.12 Instantaneous power failure continuous operation function (instantaneous power failure non-stop function)	060
8.13 Jogging operation	061
8.14 Skip frequency	062
8.15 Forward and reverse switching	062
8.16 Dynamic braking	063
8.17 Frequency Detect Output (FDT)	063
8.18 Zero Current Detection	063
8.19 Timing operation	064
8.20 Restart after power failure	064
8.21 Sleep function	064
9 RS485-MODBUS Communication Instructions	065
9.1 Networking mode	065
9.2 Interface mode	065
9.3 Communication methods	065
9.4 Protocol format	065
9.5 Protocol Applications	066
9.6 Control commands, status information, fault information	068
9.7 Parameter Management	071
9.8 Wiring Instructions	072
9.9 Communication exception code definition	072

Table of contents

9.10 Example of Modbus communication	073
10 Maintenance and troubleshooting	075
10.1 Contents of this chapter	075
10.2 Inspection items	075
10.3 Routine care and maintenance	075
10.4 Regular maintenance	076
10.5 Replacement of Vulnerable Parts of Frequency Converter	076
10.6 Troubleshooting	077
10.7 Operation exception handling	080
10.8 Fault diagnosis process	081
11 Warranty period and environmental protection and other laws and regulations	083
11.1 Warranty period	083
11.2 Environmental Protection	083
Appendix A Product Peripheral Devices	084
A.1 Connection between product and peripheral devices	084
A.2 Reactor selection	085
A.3 Classification table of braking unit and DC reactor	086
A.4 Braking resistor table	086
A.5 leakage protector	087
Appendix B General Table of Parameters	088
B.1 General table of parameters	088

1 Main purpose and scope of application

1.1 Unpacking inspection

After receiving the product, the following checks are required. If there is any discrepancy, please contact the local dealer:

1. Whether the packing box is complete, whether it is damaged or damp, etc.;
2. Whether the model logo on the outside of the packing box is consistent with the model ordered;
3. After unpacking, please check whether there is water stain inside the packing box, and whether the outer shell of the machine is damaged or broken;
4. Check whether the nameplate of the machine is consistent with the model logo on the outside of the packing box;
5. Check whether the product accessories are complete (DC reactor (built-in for products above NVF2G-S-110/TS4), instruction manual).

1.2 Main purpose

The frequency converter is mainly used for frequency conversion speed regulation, soft start, improvement of operation accuracy, improvement of power factor, overcurrent, overvoltage, overload protection and other functions for AC asynchronous motors. At the same time, it also has the effect of saving energy and reducing equipment noise.

1.3 Scope of application

There are two main types of applicable loads: 1. Constant torque type, and general-purpose models.
2. Variable torque type.

1.4 Series Model Specifications and Their Meanings

The model on the product nameplate indicates the series it belongs to by combining numbers and letters, as shown in Figure 1.1.

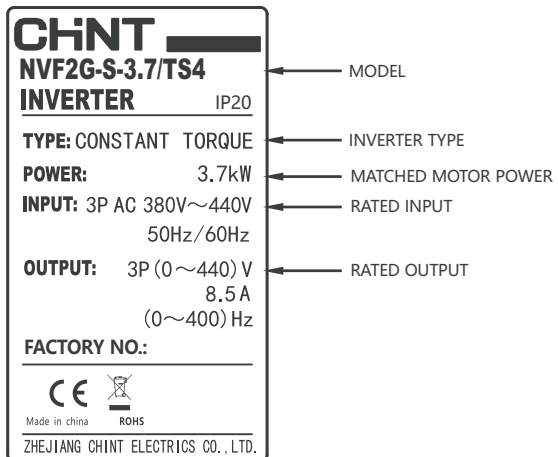

Figure 1.1 Description of nameplate

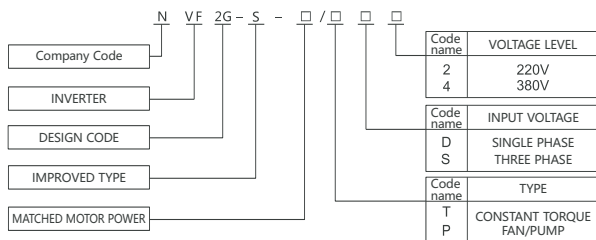

Figure 1.1 Nameplate description and model naming rules

1.5 Product specifications and models

Table 1.1 Inverter specifications and models

voltage	Specifications	battery capacity kVA	input Output Cable	Output current A	Adapted motor kW	Incoming line switch circuit breaker QF(A)
Three-phase AC 380V	NVF2G-S-1.5/T(P)S4	3	1.5	3.7	1.5	6
	NVF2G-S-2.2/T(P)S4	4.2	2.5	5.0	2.2	10
	NVF2G-S-3.7 /T(P)S4	7.6	4	8.5	3.7	16
	NVF2G-S-5.5/T(P)S4	9.9	4	12.2	5.5	20
	NVF2G-S-7.5/T(P)S4	13	6	16.2	7.5	25
	NVF2G-S-11/T(P)S4	18	10	24.6	11	40
	NVF2G-S-15/T(P)S4	25	10	31.4	15	50
	NVF2G-S-18.5/T(P)S4	29	16	37	18.5	63
	NVF2G-S-22/T(P)S4	34	16	45	22	63
	NVF2G-S-30PS4	34	25	60	22	100
	NVF2G-S-30TS4	46	25	60	30	100
	NVF2G-S-37/T(P)S4	57	25	75	37	125
	NVF2G-S-45/T(P)S4	69	35	90	45	160
	NVF2G-S-55/T(P)S4	85	35	110	55	160
	NVF2G-S-75/T(P)S4	114	50	150	75	250
	NVF2G-S-90/T(P)S4	133	70	176	90	250
	NVF2G-S-110/T(P)S4	160	120	210	110	315
	NVF2G-S-132/T(P)S4	195	120	253	132	400
	NVF2G-S-160/T(P)S4	236	120	300	160	630
	NVF2G-S-185/T(P)S4	267	240	340	185	630
NVF2G-S-200/T(P)S4	289	240	380	200	630	
NVF2G-S-220/T(P)S4	305	150*2	420	220	630	
NVF2G-S-245/T(P)S4	350	150*2	470	245	800	
NVF2G-S-280/T(P)S4	403	185*2	520	280	800	
NVF2G-S-315/T(P)S4	420	240*2	600	315	1000	
NVF2G-S-355/T(P)S4	420	240*2	640	355	1000	
NVF2G-S-400/T(P)S4	460	300*2	690	400	1000	

2 Normal use, installation and transportation, storage conditions

2.1 Conditions of use, transportation and storage

1. Use the ambient temperature (-10~ + 45)°C, derate use between 45°C~55°C, derate use by 1% for every 1°C increase in temperature;
2. Relative humidity (5~95)% RH;
3. Storage temperature -25°C~ + 55°C ,
4. If the altitude is above 1000 meters, please derate at the rate of 1 % for every 100m increase , but not more than 3000m;
5. Indoors , without direct sunlight, without dust, corrosive gas, flammable gas, oil mist, water vapor, dripping water or salt,
6. (2~9)Hz amplitude $\leq 0.3\text{mm}$, (9- 200)Hz vibration acceleration $\leq 5.8\text{m/s}^2$;

note: Inverters stored for a long time must undergo a power-on test within 2 years. When powering on, use a voltage regulator to slowly increase to the rated value, and power on for 1 hour without load, otherwise there is a risk of electric shock and explosion.

2.2 Installation conditions

When using the inverter, please pay attention to the installation spacing and distance requirements, as shown in Figure 2.1 :

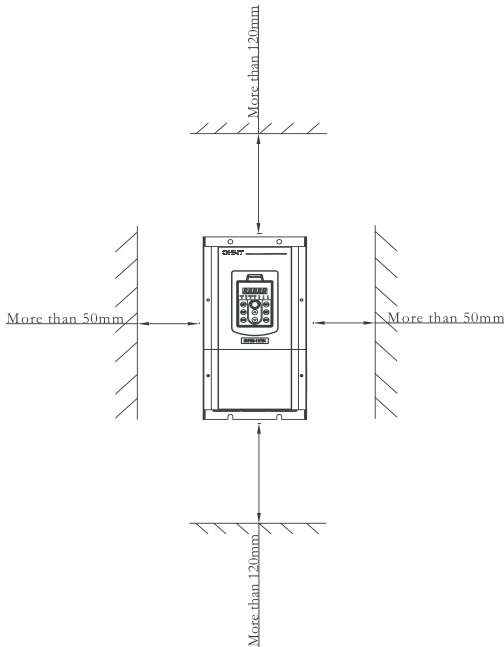

Figure 2.1 Schematic diagram of inverter installation

For multiple installations, vertical installation and inclined installation can be used.

When multiple inverters are installed vertically, windshields must be added, otherwise multiple inverters will affect each other and cause poor heat dissipation.

in Figure 2.2 :

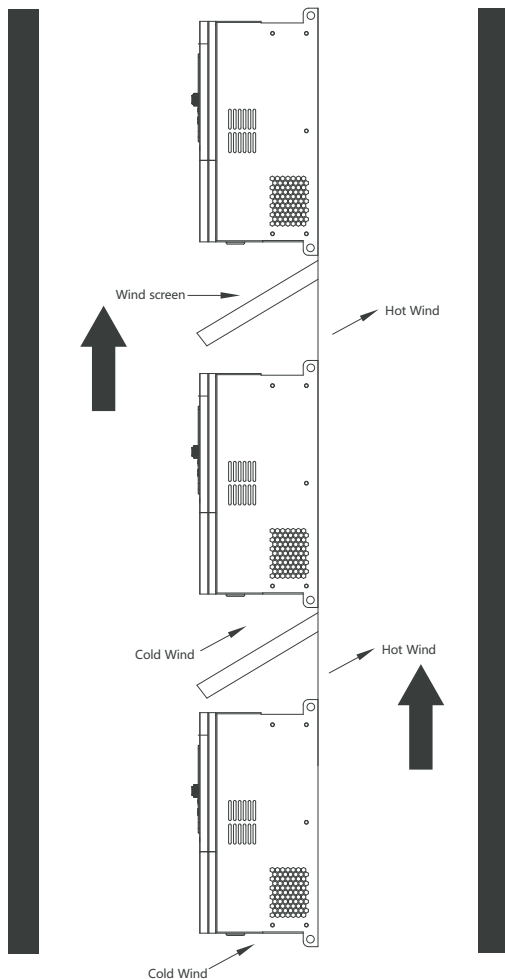

Figure 2.2 Vertical installation of multiple inverters

When multiple frequency converters are installed obliquely, it must be ensured that the air duct on the air inlet side of the inverter is separated from the air duct on the air outlet side to avoid mutual influence, as shown in Figure 2.3:

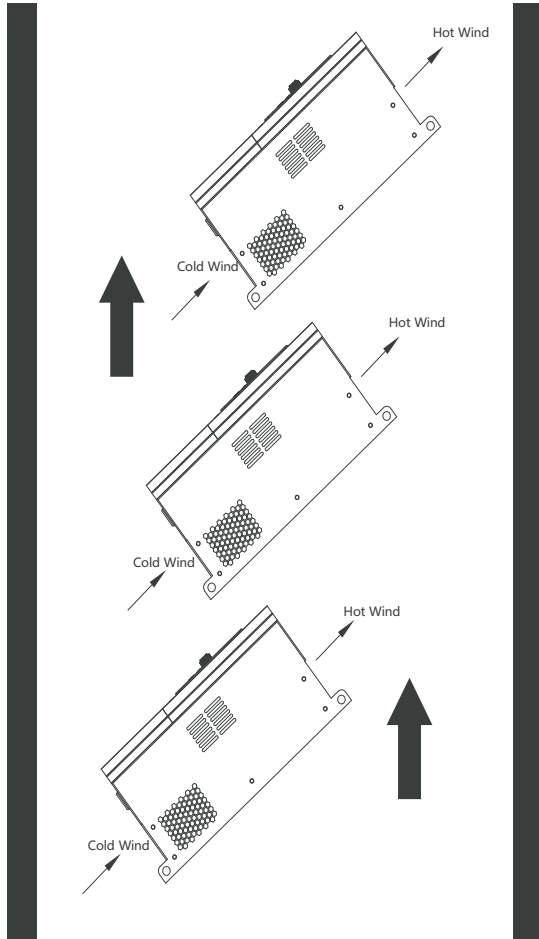

Figure 2.3 Inclined installation of multiple frequency converters

note: Since the inverter itself generates a lot of heat, when it is installed in a cabinet, the cabinet should have good heat dissipation conditions.

3 Main technical parameters and performance

3.1 Technical parameters and performance

Table 3.1 General technical specification parameters and performance

project		project description
Input	Rated voltage	Three-phase: 380~440 V: 380V(-15%) ~ 440V(+15%)
	Frequency	50Hz / 60Hz
	Voltage range	Three-phase: 380V(-15%)~440V(+ 15%)
	Frequency Range	(47~ 63)Hz
Output	Voltage	0~ rated input voltage
	Frequency	(0- 600) Hz
	Overload capacity	T : 150% rated current for 1 minute, 180% rated current for 2 seconds P type: 120% rated current for 1 minute, 150% rated current for 1 second
Main control Performance	Control method	Sensorless Vector Control(SVC) V/F control
	Modulation	Space Vector PWM Modulation
	Starting torque	150% rated torque at 0.5Hz(SVC)
	Frequency resolution	Digital setting: 0.01Hz; Analog setting: maximum frequency × 0.5%
	Torque boost	Automatic torque boost, manual torque boost
	V/F curve	Straight line V/F curve, 3 kinds of torque reduction characteristic curve methods (2.0 power ,1.7 power ,1.2 power), multi -point V/F curve method
	Acceleration and deceleration curve	Linear acceleration and deceleration (4 types)
	Automatic current limiting	Automatically limit the current during operation to prevent frequent over-current fault tripping
Customization function	Jogging	Jogging frequency range: (0.10 ~ 600.00) Hz Jogging acceleration and deceleration time (0.1 ~ 6500.0) s can be set, jogging interval time can be set
	Multi-speed operation	Realize multi-stage speed operation through control terminals
Peripheral Interface Features	Run command channel	Operation panel setting and control terminal setting communication control, which can be switched in various ways
	Digital input	6 multifunctional digital programmable inputs
	Digital output	1 channel multi-function digital programmable output
	Analog input	2 -way analog signal input , optional (0~20) mA , (4~20) mA current signal input or (0 ~10) V voltage output
	Analog output	2 channels of analog signal output , respectively optional (0~20) mA , (4~20) mA current output or (0~10) V voltage output, which can realize the output of physical quantities such as set frequency and output frequency
	Relay output	2 relay outputs , 2 normally open and normally closed. Contact capacity: NO 5A/NC 3A250V (AC)
	RS485 communication interface	1 channel, support Modbus protocol
Operation Panel	LED display	Can display more than 20 parameters such as set frequency, output frequency, output voltage, output current, etc.
	Key lock	Realize the locking of all or part of the keys
	Feature selection	Define the scope of action of some keys to prevent misuse
Protective function	With overcurrent protection, overvoltage protection, undervoltage protection, overheat protection, overload protection, phase loss protection and other protection functions	
Structure	Degree of protection	IP20
	Cooling method	Axial DC fan cooling
Installation method		Wall-mounted
Efficiency		37kW and below ≥ 93%; 45 kW and above ≥ 9.5%

4 Structural features and working principle

4.1 Product structure feature map

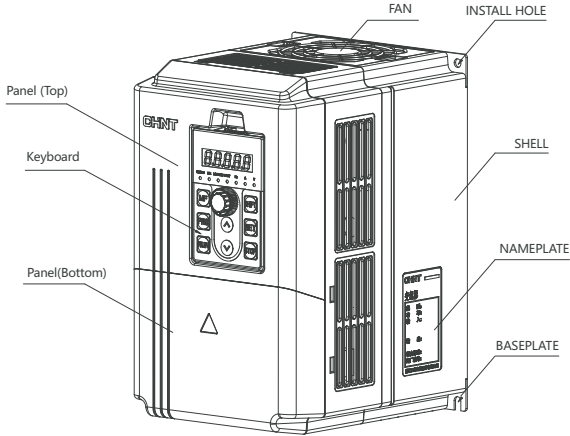

Figure 4.1 NVF2G-S-1.5/PS~NVF2G-S-11/PS4 Outline Components

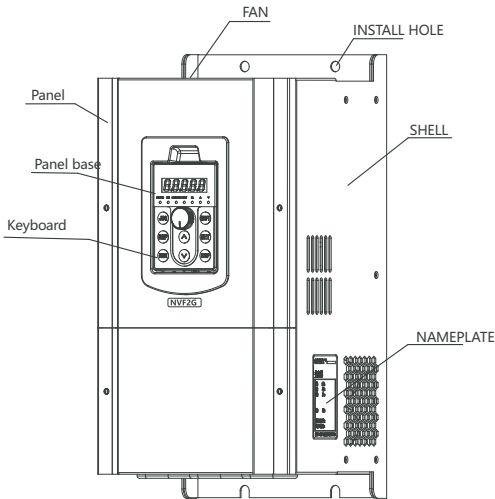

Figure 4.2 NVF2G-S-11/TS4 ~ NVF2G-S-30/PS4 Outline Components

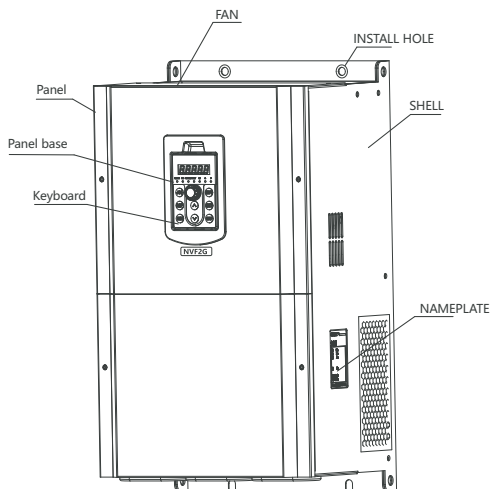

Figure 4.3 NVF2G-S-30/TS4 ~ NVF2G-S-75/TS4 external parts diagram

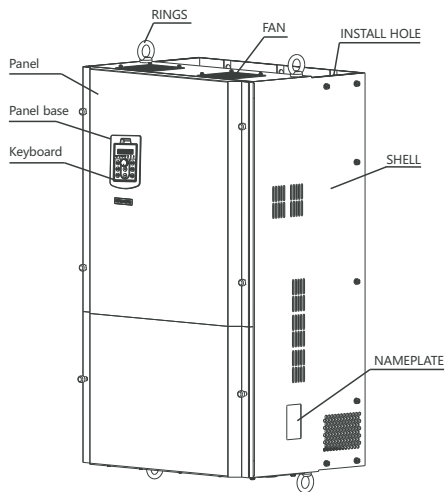

Figure 4.4 NVF2G-S-75/TS4 ~ NVF2G-S-315/PS4 Outline Components

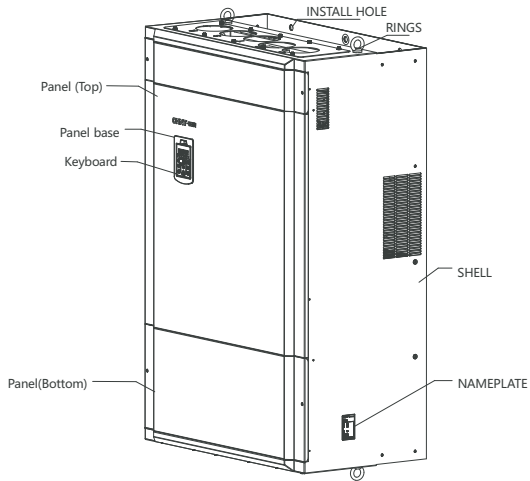

Figure 4.5 NVF2G-S-315/TS4 ~ NVF2G-S400/TS4 external parts diagram

4.2 Main circuit terminal description

(1) Three-phase (380 ~ 440) V series (NVF2G-S -1.5/PS4 ~ 30/PS4)

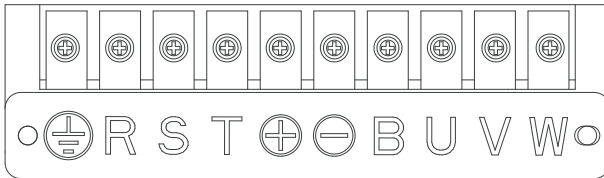

Figure 4.6 Main circuit terminal NVF2G-S-1.5/PS4 ~ 30/PS4

(2) Three-phase (380 ~ 440) V series (NVF2G-S -30/TS4 ~ 45/PS4)

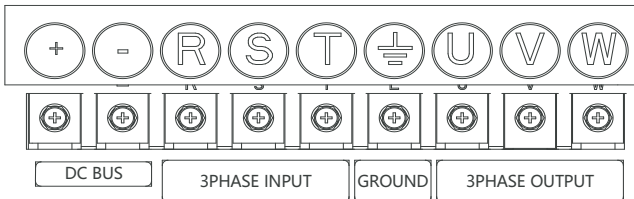

Figure 4.7 Main circuit terminals NVF2G-S-30/TS4 ~ 45/PS4

(3) Three-phase (380 ~ 440) V series (NVF2G-S-45/PS4 ~ 110/PS4)

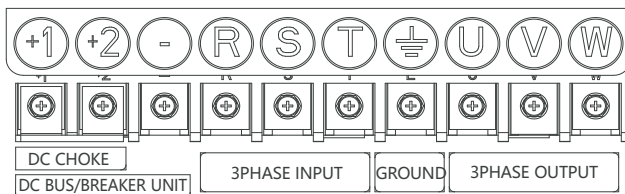

Figure 4.8 Main circuit terminal NVF2G-S-45/TS4 -110/PS4

(4) Three-phase (380 ~ 440) V series NVF2G-S-110/PS4 ~ 160/PS4

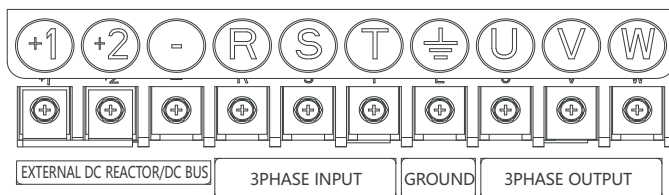

Figure 4.9 Main circuit terminal NVF2G-S-110/TS4~160/PS4

Note: ⊕, ⊙ DC reactor can be connected between , ⊕ , ⊙ DC bus positive and negative terminals; NVF2G-S-110/TS4 ~ 160/PS4 models, if braking is required, an external ⊕ brake ⊙ component is connected between .

(5) Three-phase (380 ~ 440) V series NVF2G-S-160/TS4 ~ 315/PS4

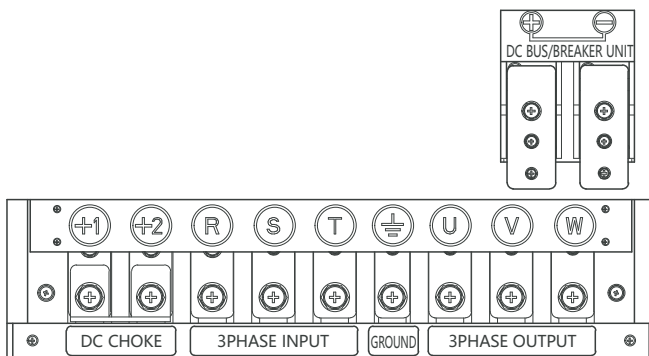
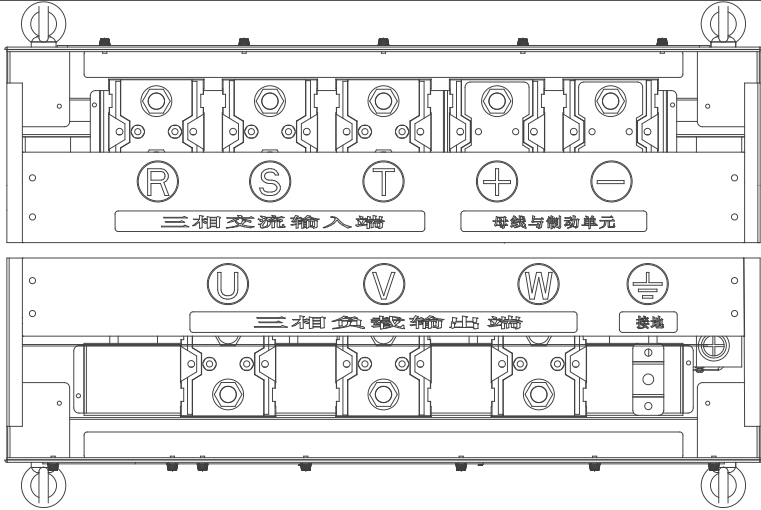

Figure 4.10 Main circuit terminal NVF2G-S-160/TS4~ 315/PS4

Note: ⊕, ⊙ can be connected with a DC reactor; ⊕, ⊙ DC bus positive and negative terminals; if braking is required , an external ⊕ braking component can be connected between , and ⊙

(6) Three-phase (380 ~ 440) V series NVF2G-S-315/TS4 ~ 400/TS4

Figure 4.11 Main circuit terminal NVF2G-S-315/TS4~400/TS4

Note : ⊕, ⊖ DC bus positive and negative terminals; if braking is required, ⊕ external ⊖ braking resistors are connected between .

Table 4.1 Main circuit terminal description table

Terminal symbol	Terminal name	Functional description
R, S, T	Main circuit power input	Three-phase AC input terminal, connected to the power grid
U, V, W	Inverter output	Three- phase AC output , generally connected to the motor
⊕	Ground terminal	The safety protection ground terminal P E must be reliably grounded
⊕ ⊖	Connection terminals for DC bus or external brake components	As a DC bus connection or an external brake component connection terminal, it needs to be connected according to actual needs
+1 -		
+1 +2	DC reactor connection terminal	For external DC reactor, please remove the short circuit when connecting DC reactor
⊕ ⊖	External braking resistor connection terminal	When it is applied to the connection terminal of an external braking resistor, connect it according to actual needs

Table 4.2 Main circuit terminal wiring and installation torque

Inverter model	R, S, T, ⊕, ⊖, ⊕, ⊖, U, V, W		
	terminal screw	Tightening torque (N·m)	Wire specification (mm ²)
NVF2G-S-1.5/P(T)S4	M4	1.2 ~ 1.5	2.5
NVF2G-S-2.2/P(T)S4	M4	1.2 ~ 1.5	2.5
NVF2G-S-3.7/P(T)S4	M4	1.2 ~ 1.5	4
NVF2G-S-5.5/P(T)S4	M4	1.2 ~ 1.5	6
NVF2G-S-7.5/P(T)S4	M4	1.2 ~ 1.5	6
NVF2G-S-11/PS4	M4	1.2 ~ 1.5	6
NVF2G-S-11/TS4	M5	2.5 ~ 3.0	6
NVF2G-S-15/P(T)S4	M5	2.5 ~ 3.0	6
NVF2G-S-18.5/P(T)S4	M5	2.5 ~ 3.0	10
NVF2G-S-22/PS4	M5	2.5 ~ 3.0	16
NVF2G-S-22/TS4	M8	9.0 ~ 10.0	16
NVF2G-S-30/P(T)S4	M8	9.0 ~ 10.0	25
NVF2G-S-37/(T)PS4	M8	9.0 ~ 10.0	25
NVF2G-S-45/P(T)S4	M8	9.0 ~ 10.0	35
NVF2G-S-55/P(T)S4	M8	9.0 ~ 10.0	50
NVF2G-S-75/P(T)S4	M8	9.0 ~ 10.0	60
NVF2G-S-90/P(T)S4	M8	9.0 ~ 10.0	70
NVF2G-S-110/PS4	M8	9.0 ~ 10.0	100
NVF2G-S-110/TS4	M10	17.6 ~ 22.5	100
NVF2G-S-132/P(T)S4	M10	17.6 ~ 22.5	150
NVF2G-S-160/PS4	M10	17.6 ~ 22.5	185
NVF2G-S-160/TS4	M12	31.4 ~ 39.5	185
NVF2G-S-185/P(T)S4	M12	31.4 ~ 39.5	185
NVF2G-S-200/P(T)S4	M12	31.4 ~ 39.5	240
NVF2G-S-220/PS4	M12	31.4 ~ 39.5	150×2
NVF2G-S-220/TS4	M16	85.2 ~ 90.4	150×2
NVF2G-S-245/P(T)S4	M16	85.2 ~ 90.4	150×2
NVF2G-S-280/P(T)S4	M16	85.2 ~ 90.4	185×2
NVF2G-S-315/P(T)S4	M16	85.2 ~ 90.4	250×2
NVF2G-S-355/P(T)S4	M16	85.2 ~ 90.4	325×2
NVF2G-S-400/P(T)S4	M16	85.2 ~ 90.4	325×2

Table 4.3 Grounding Wire Standards

Cross-sectional area of power cord	Cross-sectional area of grounding
S ≤ 16	S
16 < S ≤ 35	16
35 < S	S/2

4.3 Description of control circuit terminals

4.3.1 Control terminal and wiring diagram

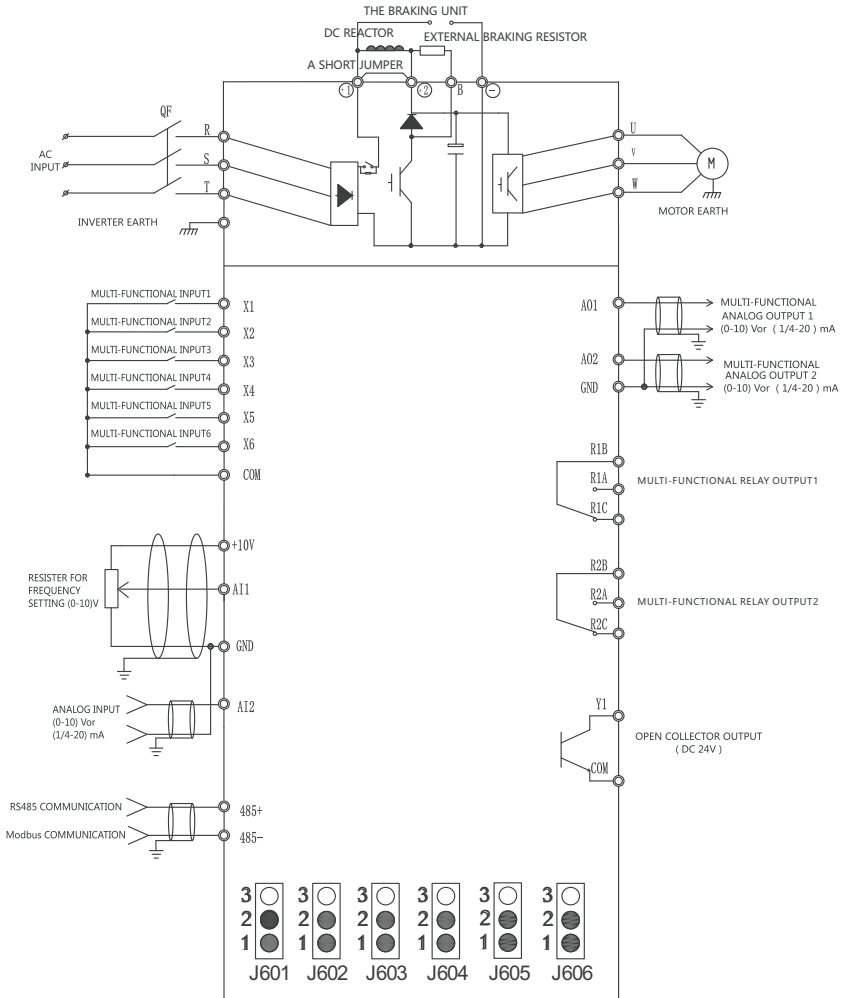

Figure 4.12 NVF2G-S-1.5/PS4~NVF2G-S-400/TS4 Wiring Diagram

4.3.2 Instructions for use of control terminals

(1) Jumper selection

Function	jumper terminal	Shorting location and definition	illustrate
AI1	J601	1-2 : V 2-3 : I	V voltage type analog input range : (-10- + 10) V; I Current analog input range : (0~20) mA or (4~20) mA
AI2	J602	1 -2:V 2-3 :I	
AO1	J603	1-2 : V 2-3 : I	V voltage type analog output range : (-10~ + 10)V; I Current analog output range : (0~20) mA or (4~20) mA
AO2	J604	1-2 : V 2-3 : I	
485 terminal matching resistance	J605	1-2 : no access 2-3 : access	Matching resistor 4.7kQ
X1-X6 interface mode	J606	1-2: PNPs 2-3: NPNs	Default is PNP type

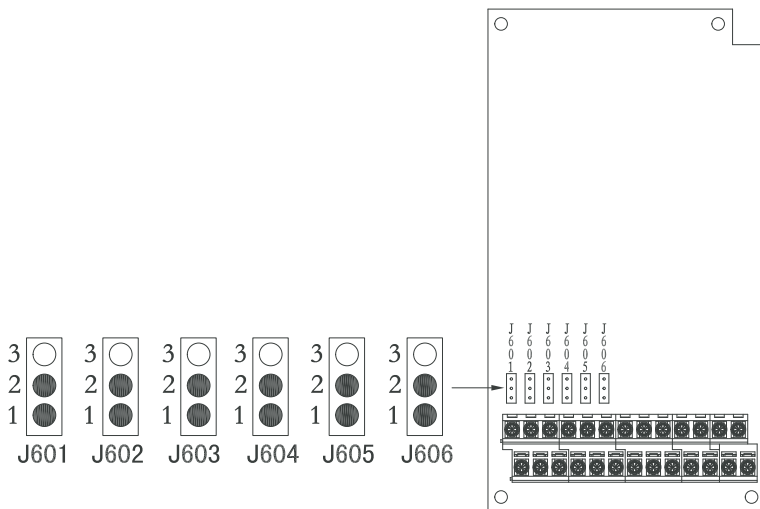

Figure 4.13 Jumper position

(2) The terminal arrangement of the control circuit is shown in Figure 4.14 below :

485+	485-	X1	X2	X3	X4	X5	X6	Y1	COM	R2A	R2B	R2C
+10V	AI2	AI1	GND	A01	A02	GND	COM	+24V	RIAS	RIB	R1C	

Figure 4.14 Arrangement of inverter control circuit terminals

4.3.3 Control terminal function description

Table 4.5 Function description of control board terminals

Terminal mark	Terminal name	illustrate
R1A, R1B, R1C, R2A, R2B, R2C	Relay contact output	RA and RB are normally open contact groups, RB and RC are normally closed contact groups, the function of RO 1 is set by parameter F6.02, the factory default default output is fault output, and the function of RO 2 is set by parameter F6.03, the factory default has no function
Y1, COM	Open collector output	The function is set by parameter 6.01, and the factory value is forward rotation state signal output.
485+, 485-	serial communication terminal	Terminal for RS485 serial communication with the outside.
+10V	Power supply for frequency setting	And A I1, AI2, GND — potentiometer (4.7k Ω ~10k Ω).
AI1,GND	Analog signal input terminal	Connect to potentiometer or 0V~10V signal as frequency setting, PID setting or PID feedback.
AI2,GND	Analog signal input terminal	Input 0V ~ 10V/0 (4) mA ~ 20mA signal as frequency setting, PID setting or PID feedback.
AO1,GND	Analog signal output terminal	Connect DC 0V - 10V/0 (4) mA ~ 20mA voltmeter between AO1 and GND, which can be used to indicate operating frequency, output current, output voltage, etc.
AO2, GND	Analog signal output terminal	Connect a DC 0V~10V/0 (4) mA ~ 20mA voltmeter between AO2 and GND, which can be used to indicate operating frequency, output current, output voltage, etc.
X1	Multi-function input terminal 1	The factory setting is forward rotation
X2	Multi-function input terminal 2	The factory setting is reverse running
X3	Multi-function input terminal 3	The factory setting is run pause
X4	Multi-function input terminal 4	The factory setting is free parking
X5	Multi-function input terminal 5	The factory setting is no function
X6	Multifunctional input terminal six	The factory setting is no function
COM	Multi-function input terminal common ground	Common land of X1~X6, use with X1~X6
24V,COM	Auxiliary power supply 24V output	DC power supply 24V output (\leq 50mA)

Notice

- 1) Terminal COM is the common terminal of X1~X6 digital control signal (multi-function input terminal), terminal GND is the common terminal of AI1, AI2, AO1, AO2 terminals, please do not connect them to the ground.
- 2) The wiring of the control circuit terminal should use shielded or twisted pair, and must be wired separately from the main circuit and strong current circuit.
- 3) The control circuit is recommended to use 0.75 mm² cables for wiring.
- 4) The control circuit cannot input strong electricity, otherwise the inverter will be damaged.

4.4 Instructions for use of control terminals

4.4.1 Multifunctional input terminal

COM is the common terminal of X1-X6, which can be a current source or a sink current. X1-X6 has flexible external interface methods, and the typical wiring methods are as follows:

- 1) For source wiring, it is necessary to short 1-2 of J606. The specific wiring diagram is shown below.

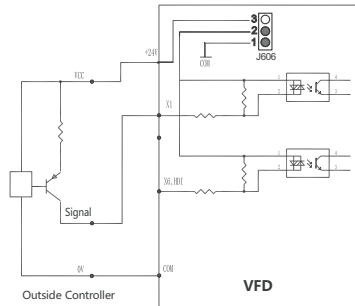

Figure 4.15 PNP type wiring diagram

2) Sink wiring needs to short-circuit 2 - 3 of J606 . The specific wiring diagram is shown below.

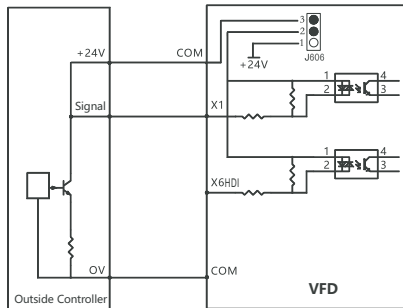

Figure 4.16 NPN type wiring diagram

4.4.2 Multi-function output terminal

(1) The multifunctional output terminal Y1 can use the +24V power supply inside the inverter, and the wiring method is shown in Figure 4.17.

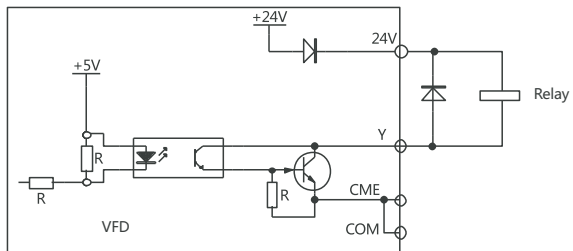

Figure 4.17 Multi-function output terminal wiring mode 1

(2) The multi-function output terminal Y1 can also use an external power supply, and the wiring method is shown in Figure 4.18.

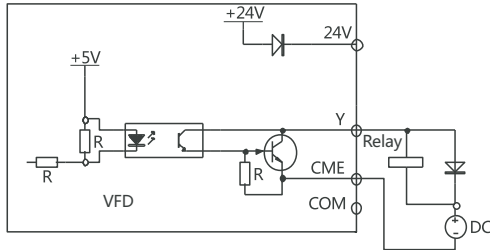

Figure 4.18 Multi-function output terminal wiring mode 2

4.4.3 Relay output terminals R1A, R1B, R1C, R2A, R2B, R2C

If driving inductive loads (such as electromagnetic relays, contactors), a surge voltage absorption circuit should be installed, such as: RC absorption circuit (note that its leakage current should be less than the holding current of the controlled contactor or relay), varistor, Or freewheeling diodes, etc. (used in DC electromagnetic circuits, be sure to pay attention to polarity when installing). The components of the absorbing circuit should be installed at both ends of the coil of the relay or contactor.

5 Product shape and installation size

5.1 Outline, installation size and weight

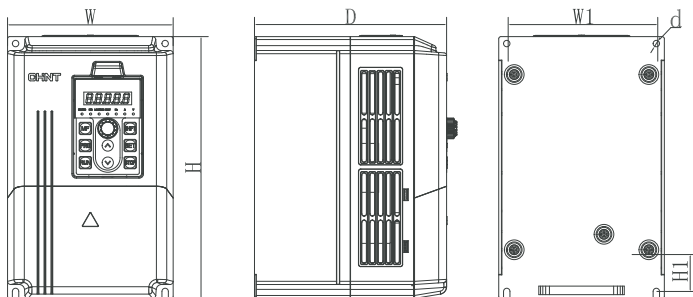

Figure 5.1 NVF2G-S-1.5/PS4 ~ NVF2G-S-11/PS4 appearance and installation dimensions

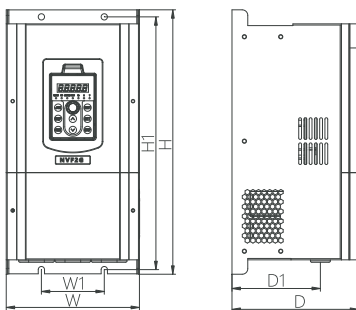

Figure 5.2 NVF2G-S ~ 11/TS4- NVF2G-S-30/PS4 outline and installation dimensions

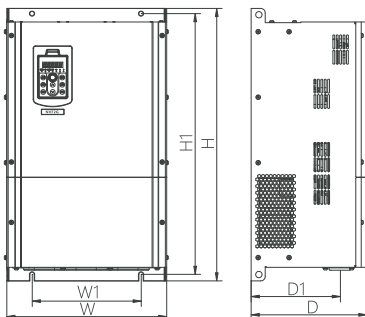
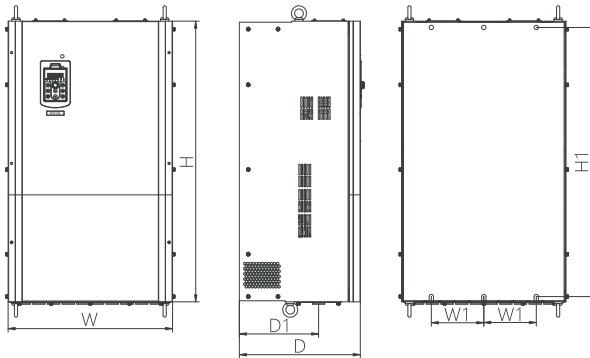
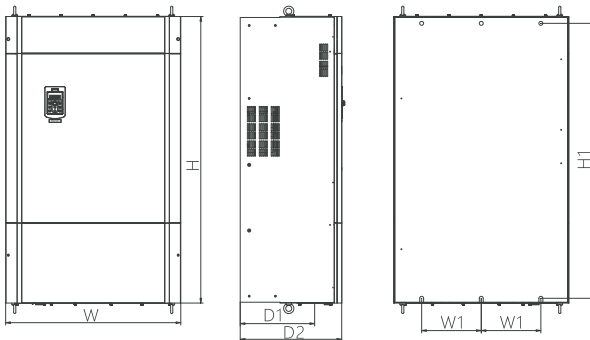

Figure 5.3 NVF2G-S-30/PS4- NVF2G-S-75/PS4 outline and installation dimensions

Figure 5.4 NVF2G-S-75/TS4~NVF2G-S-315/PS4 outline and installation dimensions

Figure 5.5 NVF2G-S~315/TS4 ~NVF2G-S-400/TS4 outline and installation dimensions
Table 5.1 Product appearance and installation dimensions and weight

product specification	W	H	D	W1	H1	D1	weight (Kg)	Remark
NVF2G-S-1.5/PS4	118	187	173	107	175	110	2.4	see picture 5.1
NVF2G-S-1.5/TS4 (2.2/PS4)								
NVF2G-S-2.2/TS4 (3.7/PS4)								
NVF2G-S-3.7/TS4 (5.5/PS4)								
NVF2G-S-5.5/TS4 (7.5/PS4)	155	247	189	140	232	125	3.6	see picture 5.1
NVF2G-S-7.5/TS4 (11/PS4)								
NVF2G-S-11/TS4 (15/PS4)	191	378	193	90	362	129	10.5	see picture 5.2
NVF2G-S-15/TS4 (18.5/PS4)								
NVF2G-S-18.5/TS4 (22/PS4)	215	426	213	120	407	164	15	see picture 5.2
NVF2G-S-22/TS4 (30/PS4)								
NVF2G-S-30/TS4 (37/PS4)	259	433	240	140	408	179	26	see picture 5.3
NVF2G-S-37/TS4 (45/PS4)								

product specification	W	H	D	W1	H1	D1	weight (Kg)	Remark
NVF2G-S-45/TS4 (55/PS4)	352	603	257	240	577	197.5	34	see picture 5.3
NVF2G-S-55/TS4 (75/PS4)								
NVF2G-S-75/TS4 (90/PS4)								
NVF2G-S-90/TS4 (110/PS4)	406	631	272	126	600	224	58	see picture 5.4
NVF2G-S-110/TS4 (132/PS4)								
NVF2G-S-132/TS4 (160/PS4)	470	807	352	150	769	226.5	108	see picture 5.4
NVF2G-S-160/TS4 (185/PS4)								
NVF2G-S-185/TS4 (200/PS4)								
NVF2G-S-200/TS4 (220/PS4)	540	892	390	180	848	256	121	see picture 5.4
NVF2G-S-220/TS4 (245/PS4)								
NVF2G-S-245/TS4 (280/PS4)								
NVF2G-S-280/TS4 (315/PS4)	710	1020	3 86	250	978	284	171.5	see picture 5.4
NVF2G-S-315/TS4(355/PS4)								
NVF2G-S-355/TS4 (400/PS4)								
NVF2G-S-400/TS4	734	1200	426	250	1152	3 13	280	see picture 5.5

5.2 Dimensions of display box and pallet

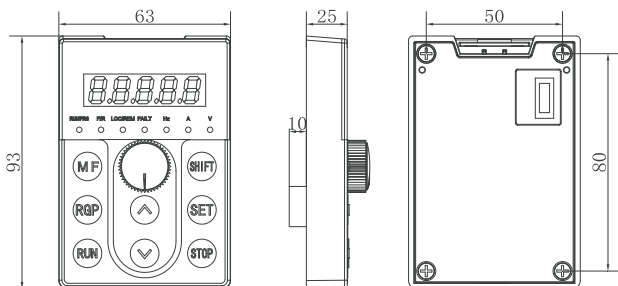

Figure 5.6 shows the size of the box

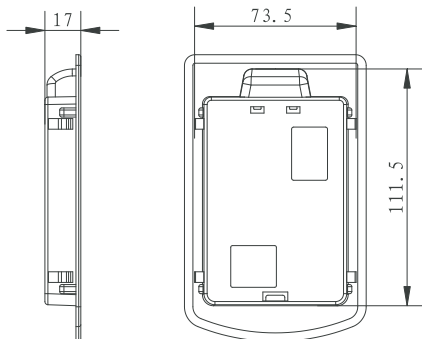

Figure 5.7 Outline Dimensions of the Pallet

Note: 73.5*111.5 is the size of the metal opening recommended for installing the pallet, and the thickness of the sheet metal is recommended not to be greater than 1.5mm;

6 Installation and Wiring

6.1 Precautions for installation

After the inverter is installed, please pay attention to check the installation of the inverter:

Step 1: Input power cables and motor cables to see if the ampacity selection meets the actual load requirements.
Step 2: Whether the peripheral accessories of the inverter are selected correctly and installed correctly; whether the installation cable meets its flow requirements; including input reactor, input carrier, output reactor, DC reactor braking unit and braking resistor.
Step 3: Whether the inverter is installed on flame-retardant materials; and whether the heating accessories (reactors, braking resistors) are kept away from flammable materials.
Step 4: Whether all control cables have been routed separately from power cables; whether the routing has fully taken into account the special requirements of E MC .
Step 5: Whether all wiring systems have been properly grounded according to the requirements of the inverter.
Step 6: Whether the installation spacing of all installations of the inverter is installed according to the requirements of the manual.
Step 7: Check whether the installation method of the inverter is consistent with the requirements in the manual; try to install it vertically.
Step 8: Confirm whether the external wiring terminals of the inverter are fastened and whether the torque meets the requirements.
Step 9: Confirm that there are no screws, cables, or other conductive objects left inside the inverter. If there is, please take it out.

Precautions	illustrate
Compared with power frequency operation	The output voltage is a PWM wave, which contains certain harmonics. Therefore, the temperature rise, noise and vibration of the motor during use are slightly increased compared with power frequency operation.
run at low speed	When the frequency converter drives an ordinary motor to run at low speed for a long time, the output torque must be reduced due to the deterioration of the heat dissipation effect of the motor. If it needs to run at low speed and constant torque for a long time, a variable frequency motor must be selected.
Motor electronic thermal protection value	When selecting a suitable motor, the frequency converter can implement thermal protection for the motor. If the rated capacity of the motor does not match the frequency converter, it is necessary to adjust the protection value or take other protection measures to ensure the safe operation of the motor.
at frequencies above 5 0Hz	If the operation exceeds 50Hz , in addition to considering the increased vibration and noise of the motor, it is also necessary to ensure the operating speed range of the motor bearings and mechanical devices. Be sure to inquire in advance .
Lubrication of mechanical devices	Mechanical devices that require lubrication, such as gearboxes and gears, may be damaged due to poor lubrication effect during long-term low-speed operation, so be sure to check in advance.
Negative torque load	For occasions such as thousands of lifting loads, negative torque often occurs, and the inverter often trips due to overcurrent or overvoltage faults. At this time, it should be considered to select a braking component with appropriate parameters.
Mechanical resonance point of load device	In a certain output frequency range, the inverter may encounter the mechanical resonance point of the load device, which must be avoided by setting the jump frequency.
Occasions with frequent start and stop	It is suitable for starting and stopping the inverter through the terminals. It is strictly forbidden to use contactors and other switching devices on the input side of the inverter for direct frequent start and stop operations, otherwise the equipment will be damaged.

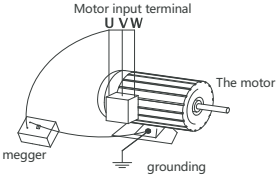
Precautions	illustrate
<p>Motor insulation inspection before connecting to the inverter</p>	<p>Before the motor is used for the first time or after being placed for a long time, the insulation of the motor should be checked to prevent the inverter from being damaged due to the insulation failure of the motor winding. Wiring as shown in the figure, please use a 500V voltage type megohmmeter when testing, and ensure that the measured insulation resistance is not less than 5MΩ .</p>  <p>The diagram illustrates the setup for testing motor insulation. A megger is connected to the motor's input terminals labeled U, V, and W. One terminal is also connected to a ground symbol labeled 'grounding'. The motor is labeled 'The motor'.</p>

6.2 Precautions for use

When the customer officially uses the inverter, please confirm:

Step 1: Confirm the type of load machinery that the inverter will drive. In actual operation, whether the inverter is overloaded; whether the inverter needs to amplify the power level.
Step 2: Confirm whether the actual operating current of the load motor is less than the rated current of the inverter.
Step 3: Whether the control precision required by the actual load is the same as the control precision that the inverter can provide.
Step 4: Confirm whether the grid voltage is consistent with the rated voltage of the inverter.
Step 5: Confirm whether the required communication method requires an optional card.

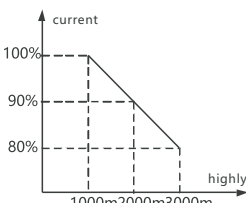
Precautions	illustrate
Capacitors or varistors to improve power factor	Since the output of the inverter is PWM wave, if a capacitor for improving the power factor or a varistor for lightning protection is installed on the output side, it will cause the inverter to trip or damage the device. Please remove it.
The use of switching devices such as contactors installed on the output terminals of the inverter	If you need to install switching devices such as contactors between the inverter output and the motor, please ensure that the inverter is on and off when there is no output, otherwise the inverter may be damaged.
Use other than the rated voltage value	It is not suitable to use the frequency converter outside the allowable operating voltage range, if necessary, please use the corresponding step-up or step-down device for voltage transformation.
Lightning Surge Protection	The inverter is equipped with a lightning overcurrent protection device, which has a certain self-protection ability against induced lightning.
Altitude and Derating	<p>In the area where the altitude exceeds 1000 meters, the heat dissipation effect of the inverter is deteriorated due to the thin air, so it is necessary to derate for use. The relationship curve between the rated current of the inverter and the altitude.</p>  <p>The graph plots current percentage against altitude in meters. At 1000m, the current is 100%. At 2000m, the current is 90%. At 3000m, the current is 80%. The x-axis is labeled 'highly' and the y-axis is labeled 'current'.</p>

6.3 EMC Precautions in Wiring

EMC stands for Electromagnetic Compatibility, which refers to the ability of a device or system to work normally in its electromagnetic environment without constituting anything in the environment that cannot withstand electromagnetic disturbance. The two properties that judge it good or bad are:

1. The level of electromagnetic noise generated when the equipment is working;
2. The ability level of operating equipment to resist electromagnetic noise from the surroundings.

The working principle of the frequency converter determines that it will generate a certain amount of electromagnetic interference noise, which will affect the equipment and nearby instruments and meters. At the same time, in order to ensure that the frequency converter can work reliably in a certain electromagnetic environment, it must have a certain ability to resist electromagnetic interference. Correctly installing the inverter can reduce the electromagnetic noise of the equipment and improve the anti-interference ability of the equipment itself. In order to ensure the long-term normal operation of the power system, please refer to the following introduction to install the inverter.

6.3.1 On-site wiring

Power wiring: In different control systems, the power supply line is independently powered from the power transformer, generally using 4-core lines (3 of which are the main circuit power line, and 1 is the ground line). The ground line is at the near end of the inverter Ground, and the other side is connected to the motor casing.

Equipment classification: Generally, there are different electrical equipment in the same control cabinet, such as inverters, filters, PLCs, testing instruments, etc., which are divided into strong noise equipment and noise sensitive equipment according to the ability to emit electromagnetic noise and withstand noise. Install similar equipment in the same area,

Keep a distance of more than 20cm between different types of equipment, and it is best to separate different areas with metal shells or ground partitions in the cabinet.

Wiring in the control cabinet: There are generally main circuit power lines (strong current) and signal lines (weak current) in the control cabinet. The signal lines are easily interfered by the main circuit power line and cause equipment malfunction. When wiring, the signal line and the main circuit power line should be distributed in different areas. The cables in different areas should not be placed in the same cable tray. The two cannot be tied together. If the signal cable must cross the power line, the angle between the two should be kept at 90 degrees. The incoming and outgoing wires of the main circuit power lines cannot be staggered or bundled together.

6.3.2 Noise suppression and grounding

The frequency converter must be grounded safely and reliably when it is working. Grounding is not only for equipment and personal safety, but also the simplest, most effective, and lowest-cost method to solve EMC problems. It should be given priority.

All inverter control terminal connection wires use shielded wires, and the shielded wires connect the shielding layer to the nearest ground at the entrance of the inverter, and the grounding uses cable clips to form a 360-degree ring connection.

It is strictly forbidden to twist the shielding layer into a pigtail and then connect it to the inverter ground, which will greatly reduce or even lose the shielding effect. The connecting wire (motor wire) between the inverter and the motor adopts a shielded wire or an independent wiring trough, and the shielding layer of the motor wire or the metal of the wiring trough

One end of the casing is connected to the ground of the frequency converter, and the other end is connected to the motor casing.

The ground wire should be as short and thick as possible to minimize ground impedance.

Arrange the grounding cable away from the input and output wiring of noise-sensitive equipment.

6.3.3 Leakage current suppression

Leakage current includes leakage current between lines and leakage current to ground. Its size depends on the distributed capacitance of the system wiring and the carrier frequency of the inverter. Reducing the carrier frequency and selecting the shortest motor cable can effectively reduce the leakage current; when the motor cable is long (more than 100m), an AC reactor or a sine wave filter should be installed on the output side of the inverter; when the motor cable is longer, a reactor should be installed at intervals. The two classification of

leakage current and their manifestation methods are as follows:

- (1) Leakage current to the ground: refers to the leakage current flowing through the common ground wire, which not only flows into the inverter system but also may flow into other equipment through the ground wire. These leakage currents may cause leakage circuit breakers, relays or other equipment to malfunction;
- (2) Leakage current between lines: refers to the leakage current flowing through the distributed capacitance between the input and output cables of the inverter. The magnitude of the leakage current is related to the carrier frequency of the inverter, the length of the motor cable, and the cross-sectional area of the cable. The higher the carrier frequency of the inverter, the longer the motor cable, and the larger the cross-sectional area of the cable, the greater the leakage current.

6.3.4 Power supply filtering

The filter can play a very good role in electromagnetic decoupling, even if the working conditions are met, it is recommended that the user install it.

The installation method and precautions are as follows:

- (1) The filter is installed between the motor and the frequency converter and between the power supply and the frequency converter. The installation position should be close to the frequency converter, and the length of the lead wire should be shortened as much as possible;
- (2) Make sure that the filter shell is in good contact with the chassis shell, and connect the grounding wire;
- (3) The input and output lines of the inverter filter should be kept apart, and parallel lines should not be avoided, so as not to reduce the electrical performance of the inverter filter.

6.4 Power on for the first time

Please follow the technical requirements provided in this chapter for installation and wiring. The power-on process is shown in Figure 6.1 :

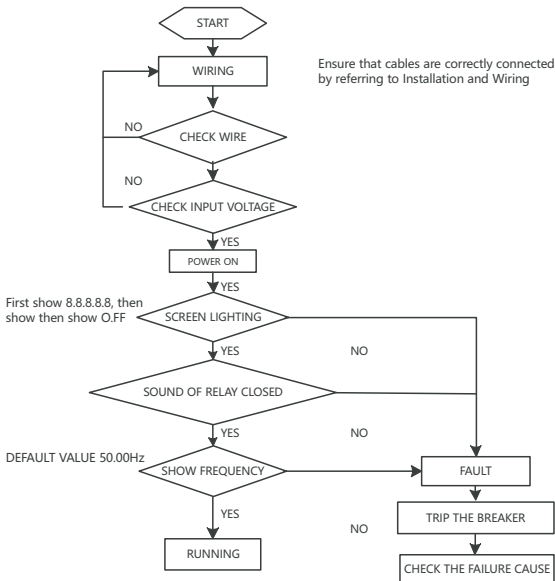

Figure 6.1 Inverter power-on operation process

7 Operation and debugging

7.1 Operation panel introduction

7.1.1 Schematic diagram of the operation panel

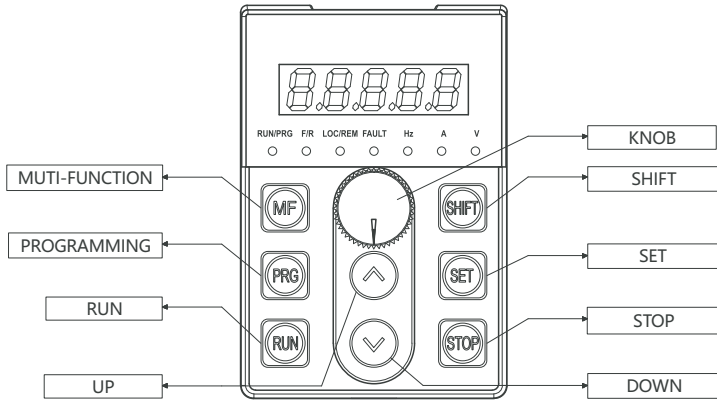

Figure 7.1 Schematic diagram of LED operation panel

The operation panel is the main unit for the inverter to accept commands, display parameters and set parameters. There are 8 keys and a navigation key on the inverter operation panel, and the function definition of each key is shown in Table 7.1.

7.1.2 Operation panel function table

Table 7.1 Operation panel function list

key	name	Function
	Program / Exit Key	Enter or exit programming state
	Ok Key	Enter the lower menu or confirm the data
	Increment Key	Increment of data or function code
	Down Key	Decrement of data or function code
	Shift Key	You can choose to set the modification bit of the data; in the main interface, you can switch the display status parameters
	Multifunction Key	Jogging, free stop or fast stop function can be performed, the function of this key is set by F7.02
	Run Key	In operation panel mode, press this key to run
	Stop / Reset Key	Shutdown or fault reset
	Navigation Key	When modifying the data, the rotation can realize the increment or decrement of the data, and when the navigation key is pressed, it is the confirmation function

In addition to the single button function, the button can also realize the combined button function, as shown in Table 7.2:

Table 7.2 Operation panel function table

button	name	Function
+	Key Lock Key	Key lock operation can be performed according to the function of F7.01
+	Key Unlock	Key unlock operation possible
+	Panel Self-test Key	Perform panel self-test operation

7.1.3 Description of LED digital tube and indicator light

There are five 8-segment LED digital tubes, 3 unit indicator lights, and 4 status indicator lights on the inverter LED operation panel. The digital tube can display the inverter's main interface status parameters, menu interface codes, function code parameters and fault alarm codes, etc. Please refer to Table 7.3 for the corresponding relationship between the displayed symbols of the digital tube and the characters/numbers.

Table 7.3 Displays the correspondence between symbols and characters/numbers

LED display	meaning	LED display	meaning	LED display	meaning	LED display	meaning
	0		A		I		S
	1		b		J		T
	2		C		L		t
	3		c		N		u
	4		d		no		v
	5		E		o		the y
	6		f		o		-
	7		G		P		8.
	8		h		q		.
	9		h		r		k

The 3 unit indicators correspond to Hz, A, V and other unit indications, as shown in Figure 7.2 .

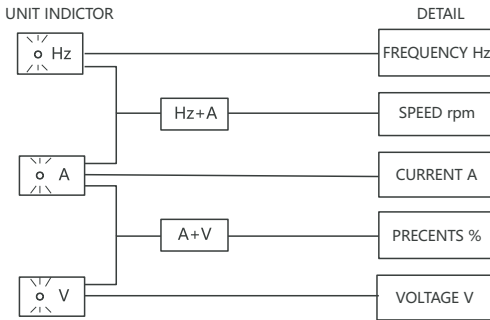

Figure 7.2 Explanation diagram of unit indicator light

Table 7.4 Description of Status Indicators

indicator light	Display state	Indicates the current status of the drive
Running status indicator (RUN/PRG)	Bright	Operating status
	off	downtime
Running direction indicator (F/R)	Bright	run in default direction
	off	run in opposite direction
Running command channel indicator light (LOC/REM)	Bright	Operation panel control status
	off	Terminal control state
	flashing	communication control state
Fault indication (FAULT)	Bright	Fault state
	off	normal status

7.1.4 Display status of the operation panel

The state display of the operation panel is divided into stop state parameter display, running state parameter display and function code parameter editing state display. The status display description is shown in Table 7.5.

Table 7.5 Description of status display

Status Display	Instructions	Related parameters
Shutdown parameter display	The inverter is in stop state, press SHIFT key, it can cycle display different stop state parameters.	The stopped state parameters to be viewed are defined by function code F7.07
Running parameter display	When the inverter enters the running state, the RUN /PRG indicator light on the panel is on, and the F/R indicator light is on or off depending on the current running direction. Press the SHIFT button to cycle display the running status parameters.	The operating status parameters to be viewed are defined by function codes F7.05 and F7.06
fault display	When the inverter detects a fault signal, it enters the fault alarm display state, at this time the FAULT light is on and the fault code is displayed. The fault reset operation can be performed through the STOP key on the operation panel, the control terminal or the communication command. If the fault persists, the fault code will remain displayed.	Fault status parameters can also be viewed through function code FE.06~FE.12
Function code editing	In the shutdown, running or fault alarm state, press the PRG key to enter the editing state (if there is a user password, see the description of F7.00), the editing state is displayed in a two-level menu , and the sequence is: function code group number → function index number → function code parameter.	All editable parameters

7.2 Example of panel operation

Various operations can be performed on the inverter through the operation panel, including reading read-only parameters, modifying parameters, modifying set frequency, keyboard lock and unlock, user password service, hexadecimal parameter setting method, monitoring running status parameters, etc. , enumerate relevant examples as follows:

Example 1: Read read-only parameters

When reading read-only parameters, the parameters can only be read and cannot be modified. Taking reading the value of the current bus voltage Fd.16 as an example, the operation steps are as shown in Figure 7.3, and the operation steps of other read-only parameters can be deduced by analogy.

Among them, "*" means flashing, the same below .

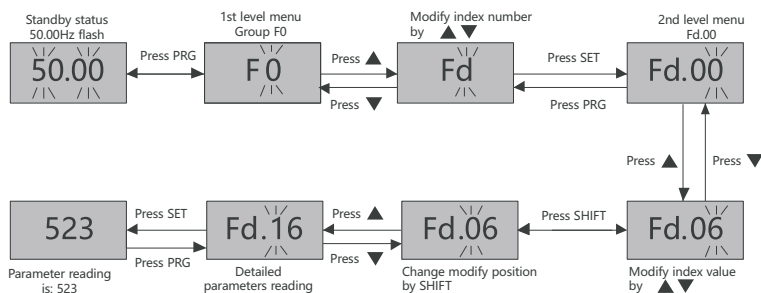

Figure 7.3 Example of reading read-only parameters

In the function parameter display state, if the parameter has no flashing bit, it means that the function code cannot be modified, and the possible reasons are as follows:

- (1) This function code is an unmodifiable parameter. Such as actual detection parameters, operation record parameters, etc.;
- (2) This function code cannot be modified in the running state, and can only be modified after stopping the machine;
- (3) Parameters are protected. When the function code F7.03 is 1 or 2, the function code cannot be modified. This is to protect the parameters from misoperation. For details, refer to the description of F7.03.

Example 2: modify parameters

When modifying parameters, take modifying the set frequency F0.05 as an example, modify 50.00Hz to 30.00Hz. The operation steps are as shown in Figure 7.4, and the operation methods of other modifiable parameters can be deduced in the same way :

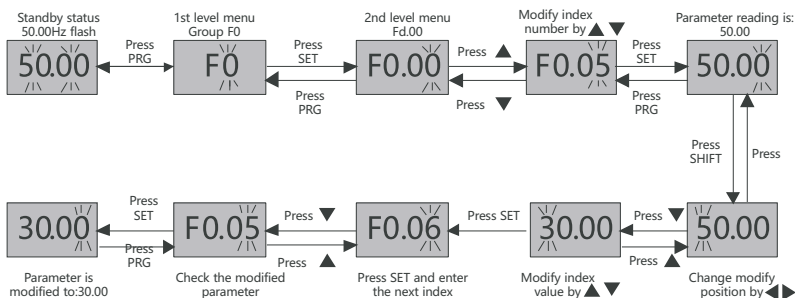

Figure 7.4 Operation example of modifying parameters

Example 3: Modify the set frequency

After the inverter is powered on, the set frequency can be directly modified by pressing the ▲ or ▼ keys. Example: To change the set frequency from 50.00Hz to 40.00Hz, the operation steps are as shown in Figure 7.5:

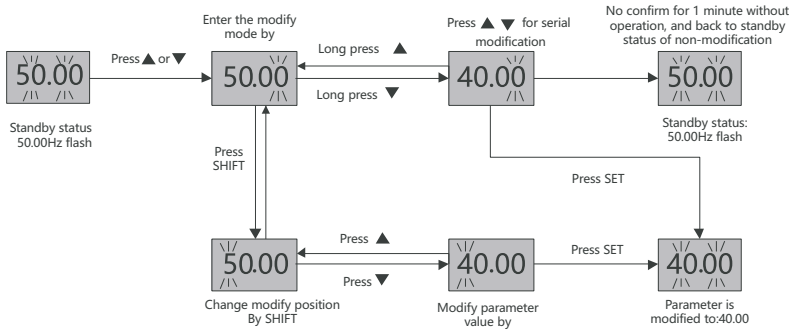

Figure 7.5 Operation example of modifying the set frequency



Notice

When modifying the set frequency, if you do not press SET to confirm, if there is no operation for 2 seconds, it will return to the stop state before modification.

Example 4: Keyboard lock and unlock

by function F7.0 . Take "F 7.01 is set to 1, fully locked" as an example, as shown in Figure 7.6 .

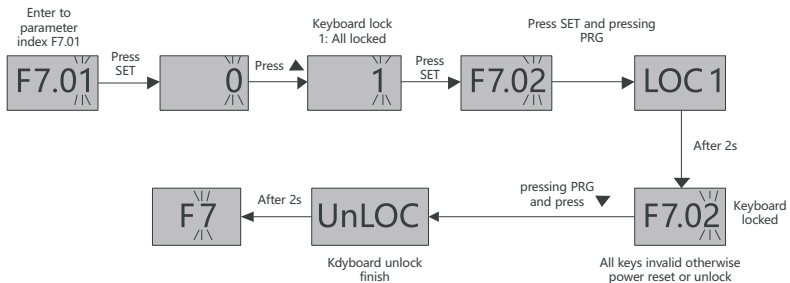

Figure 7.6 Lock panel operation example



Notice

F 7.01 is set to the locked state, the operation panel is locked every time the inverter is powered on.

Example 5: User password service

In order to protect the parameters, the inverter provides a password protection function. When F7.00 is set to a non-zero value, it is the user password. Exit the function code editing state, and the password protection takes effect. When pressing the PRG key again to enter the function code editing state, it will display "0000". Enter the function code editing state.

Take setting the user password as "1001" as an example, the operation is shown in Figure 7.7:

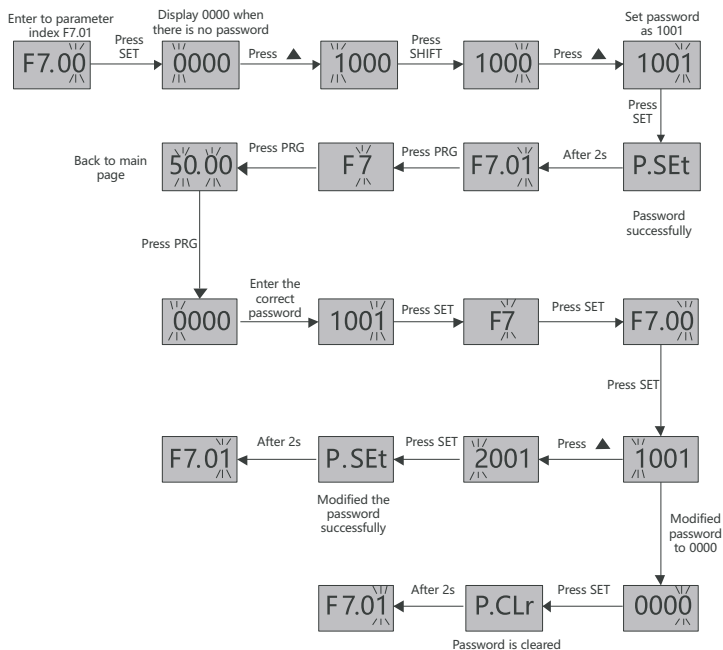



Figure 7.7 Example of user password service operation

 Notice	<ol style="list-style-type: none"> 1. After the user password is reset, the password will take effect immediately after exiting the function code editing interface. 2. After entering the user password correctly, if there is no key operation within 2 minutes, the inverter will be locked again. 3. If the user forgets the user password, he can consult the relevant technical support of our company for help.
--	---

Example 6: Setting method of hexadecimal parameters

When the digital tube displays hexadecimal, for example, check the running status parameters through F7.05: output frequency, set frequency, bus voltage, output current, PID feedback, PLC current segment number. Since each bit is independent of each other, the values of ones, tens, hundreds and thousands should be set respectively. At this time, the binary value of each bit is determined first, and then the binary number is converted into a hexadecimal number. Conversion of binary settings to hexadecimal

The relationship is shown in Table 7.6:

Table 7.6 Binary setting and hexadecimal conversion comparison table

binary settings				Hexadecimal (LED bit display value)
BIT3	BIT2	BIT1	BIT0	
0	0	0	0	0
0	0	0	1	1
0	0	1	0	2
0	0	1	1	3
0	1	0	0	4
0	1	0	1	5
0	1	1	0	6
0	1	1	1	7
1	0	0	0	8
1	0	0	1	9
1	0	1	0	A
1	0	1	1	B
1	1	0	0	C
1	1	0	1	D
1	1	1	0	E
1	1	1	1	f

The LED digit refers to the thousands digit, hundreds digit, tens digit or ones digit displayed by the LED on the operation panel.

the corresponding relationship shown in Figure 7.8, we can know that:

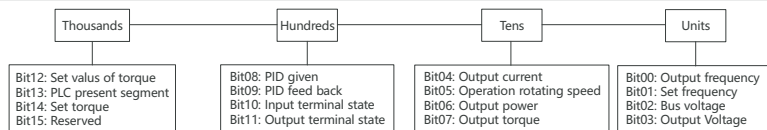
Figure 7.8 Correspondence diagram of each bit of LED

LED units setting:

Since the output frequency, set frequency, and bus voltage need to be displayed, and are determined by Bit00, Bit01, and Bit02, the ones digit corresponds to

0111, converted to hexadecimal is 7, so the ones digit is set to 7.

LED tens setting:

Since the output current needs to be displayed and is determined by Bit04, the tens digit corresponds to 0001 at this time, which is converted to 1 in hexadecimal, so the tens digit is set to 1.

LED hundreds setting:

Since the PID feedback needs to be displayed and is determined by Bit09, the hundreds digit corresponds to 0010 at this time, which is 2 in hexadecimal, so the hundreds digit is set to 2.

LED thousands setting:

Since the current segment number of the PLC needs to be displayed, and it is determined by Bit13, the thousand digit corresponds to 0010, which is 2 in hexadecimal, so the thousand digit is set to 2.

To sum up: F7.05 is set to 2217.

Example 7: Monitoring running status parameters

When displaying the corresponding parameter value of Fd group, the operation panel will refresh the current value in real time; in the main interface, we can directly monitor the operation

Running status parameters, for example, the running status parameters that need to be monitored are: output frequency, set frequency, bus voltage, output current, PID feedback, PLC current segment number. The running state parameters are determined by the function codes F7.05 and F7.06. From Example 6, it is sufficient to set F7.05 to 2217 and F7.06 to 0000. The specific operation is shown in Figure 7.9:

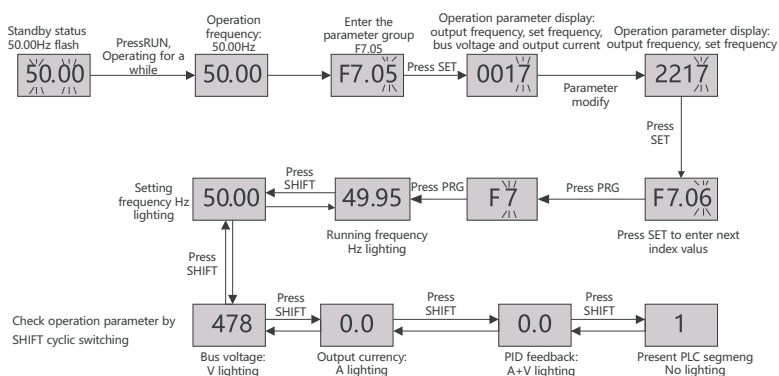

Figure 7.9 Operation example of monitoring running state parameters

7.3 Common parameters

7.3.1 Common parameters

Table 7.7 List of Common Parameters

function code	name	Attributes	Detailed description of parameters	default value
F0.00	control mode selection	⊙	0: SVC control ; 1: V/ F control	1
F0.01	run command channel selection	○	0 : keyboard control 1 : terminal control 2 : Communication Control	0
F0.02	Main frequency source selection	○	0: digital setting; 1: AI1; 2: AI2; 3 : reserved ; 4 : reserved ; 5: Multi-segment instructions ; 6 : Simple PLC; 7 : Closed-loop PID; 8: Communication given frequency	0
F0.05	digital setting	○	F0.09 ~ F0.08	50 .00Hz
F0.06	Motor running direction	○	0 : default direction; 1 : reverse operation; 2: No reversing	0
F0.07	output frequency	⊙	F0.08 ~ 600.00Hz	50.00Hz
F0.08	frequency cap	○	F0.09 ~ F0.07	50.00Hz
F0.09	Operating frequency lower limit	○	0.00Hz ~ F0.08	0.00Hz
F0.14	Acceleration time 1	○	(0.0 ~ 6500.0)s	Model confirmed
F0.15	Deceleration time 1	○	(0.0 ~ 6500.0)s	Model confirmed

function code	name	Attributes	Detailed description of parameters	default value
F0.20	parameter initialization	⊙	0: invalid operation 1: Clear fault record information 2: Restore factory parameters (except motor parameters) 3 : Restore factory defaults for custom parameters (except motor parameters) 4: All parameters restore factory defaults 5: Backup parameters 6 : Use backup parameters 7 : Save backup parameters Note: Only when the backup parameters are used, the backup parameters can be saved; otherwise, after power -off and power-on, except for the modified parameters, other parameters will still be the original parameter values.	0
F2.00	Motor Type Selection	●	0: Ordinary asynchronous motor	0
F2.01	Motor rated power	⊙	(0.1 ~ 1000.0) kW	Model confirmed
F2.02	Motor rated voltage	⊙	1 V ~ inverter rated voltage	Model confirmed
F2.03	Motor rated current	⊙	(0.01 ~ 600.00)A (inverter power<=55kW) (0.1 ~ 6000.0)A (inverter power>55kW)	Model confirmed
F2.04	Motor rated frequency	⊙	0.01Hz ~ F0.07	Model confirmed
F2.05	Number of motor poles	⊙	2 to 24	4
F2.06	Motor rated speed	⊙	(0 ~ 65535)rpm	1430rpm
F2.22	Motor parameter self-learning	⊙	0: no operation; 1: Motor static self-learning; 2: Motor dynamic self-learning	0

7.3.2 Basic debugging process

The basic debugging process is shown in Figure 7-10

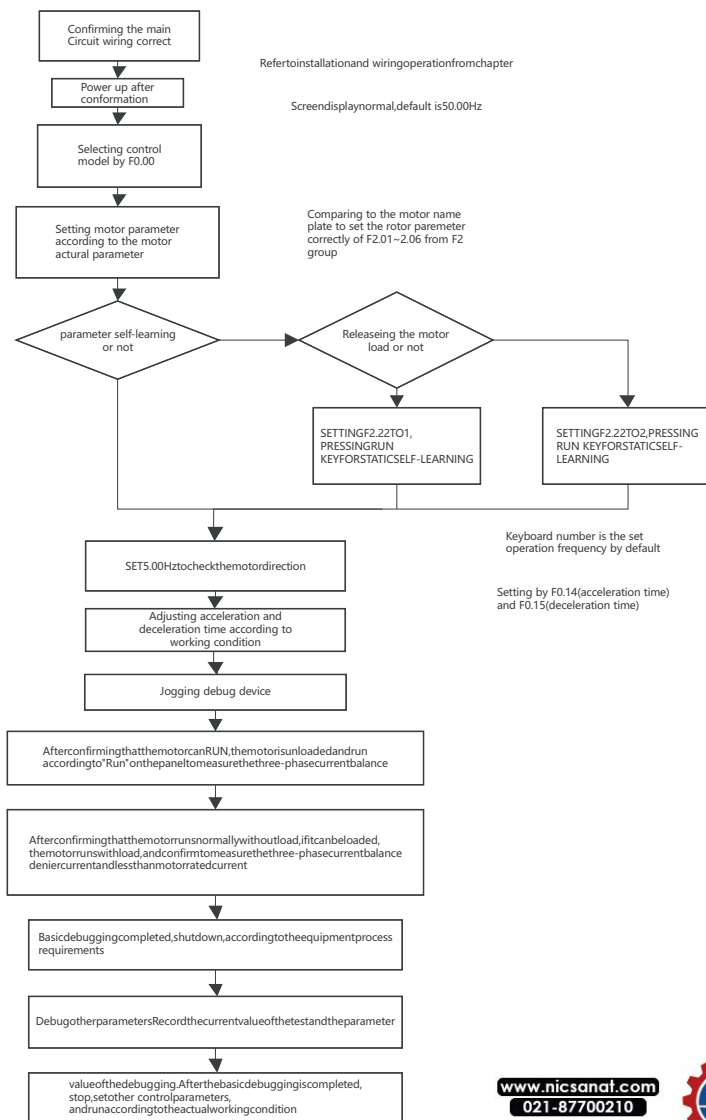

Figure 7-10 Basic debugging operation diagram

www.nicsanaf.com
021-87700210



8 Detailed Explanation of Basic Function Parameters

8.1 Running command setting

The running command is used to control the start, stop, forward rotation, reverse rotation and jogging operation of the inverter.

There are 3 modes of running command: panel, terminal and communication, and the parameter F0.01 can be set to select the running command.

function code	name	default value	Predetermined area	Parameter Description
F0.01	run command channel selection	0	0	operation panel
			1	terminal control
			2	communication control

8.1.1 Operation panel setting operation command

Set parameter F0.01=0, and control the start and stop of the inverter through the RUN and STOP keys on the operation panel. Press the RUN button and the inverter will start running, and the RUN indicator light will be on; when the inverter is running, press the STOP button, the inverter will stop running, and the RUN indicator light will be off.

function code	name	default value	Predetermined area	Parameter Description
F5.09	Terminal control mode selection	0	0	Two-wire control mode 1
			1	Two-wire control mode 2
			2	Three-wire control mode 1
			3	Three-wire control mode 2

You can arbitrarily select the multi-function input terminals of X1 ~ X6 as external input terminals, that is, by setting F5.01 ~ F5.06

to select the function of the X1 ~ X6 input terminals.

- Two-wire control mode 1:

As shown in the figure below, when K1 is closed alone, the inverter runs forward; when K2 is closed alone, the inverter runs reversely; when K1 and K2 are closed or disconnected at the same time, the inverter stops running.

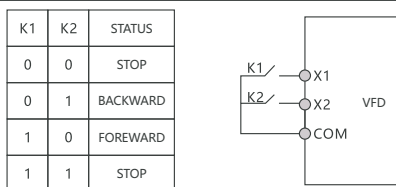

Figure 8-1-1 Two-wire control mode 1

The function code is set as follows:

function code	name	set value	Parameter Description
F0.01	run command channel selection	1	terminal control
F5.09	Terminal control mode selection	0	Two-wire control mode 1
F5.01	X1 terminal function selection	1	Forward rotation (FWD)
F5.02	X2 terminal function selection	2	reverse (REV)

- Two-wire control mode 2:

In this mode, the X1 terminal is the running enable terminal, and the function of the X2 terminal is to determine the running direction. As shown in the figure below, in this mode

When K1 is closed, K2 is disconnected, the inverter runs forward, and K2 is closed, the inverter rotates reversely; when K1 is disconnected, the inverter stops running.

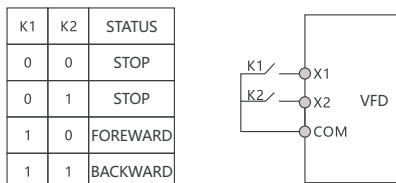
Figure 8-1-2 Two-wire control mode 2

The function code is set as follows:

function code	name	set value	Parameter Description
F0.01	run command channel selection	1	terminal control
F5.09	Terminal control mode selection	1	Two-wire control mode 2
F5.01	X1 terminal function selection	1	Forward (acts as "run enable")
F5.02	X2 terminal function selection	2	Reverse (acts as "forward and reverse running direction")

• Three-wire control mode 1:

In this mode, terminal X3 is the running enable terminal, and the direction is controlled by X1 and X2 respectively. As shown in the figure below, in this control mode, when the SB1 button is closed, press the SB2 button to rotate the inverter forward, press the SB3 button to reverse the inverter, and the SB1 button is disconnected to stop the inverter instantly.

The SB1 button must be kept in the closed state, and the commands of the SB2 and SB3 buttons will take effect at the edge of the closing action.

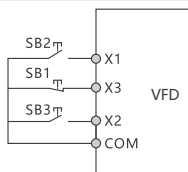
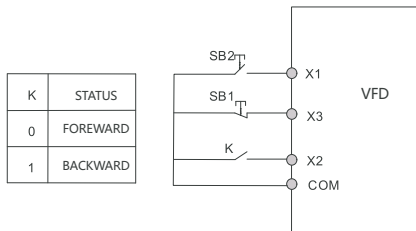

Figure 8-1-3 Three-wire control mode 1

The function code is set as follows:

function code	name	set value	Parameter Description
F0.01	run command channel selection	1	terminal control
F5.09	Terminal control mode selection	2	Two-wire control mode 1
F5.01	X1 terminal function selection	1	Forward rotation (FWD)
F5.02	X2 terminal function selection	2	reverse (REV)
F5.03	X3 terminal function selection	5	Three-wire operation control

• Three-wire control mode 2:

In this mode, X3 terminal is the running enable terminal, the running command is given by X1, and the direction is determined by the state of X2. As shown in the figure below, in this control mode, when the SB1 button is closed, the inverter runs when the SB2 button is pressed, the K is turned off, and the inverter runs forward, and the K is closed, the inverter is reversed; the moment the SB1 button is turned off, the inverter stops. During normal startup and operation, the SB1 button must be kept in the closed state, and the command of the SB2 button will take effect at the edge of the closing action.

Figure 8-1-4 Three-wire control mode 2

The function code is set as follows:

function code	name	set value	Parameter Description
F0.01	run command channel selection	1	terminal control
F5.09	Terminal control mode selection	3	Three-wire control mode 2
F5.01	X1 terminal function selection	1	Forward (acts as "run enable")
F5.02	X2 terminal function selection	2	Reverse (acts as "forward and reverse running direction")
F5.03	X3 terminal function selection	5	Three-wire operation control

8.1.3 "Communication" setting operation command

Set parameter F0.01=2, communication can realize the start, stop and other related command control of the inverter.

NVF2G-S can support RS485 communication, see the appendix for details of Modbus communication protocol.

8.2 Frequency command setting

There are three types of frequency command input, namely main frequency command, auxiliary frequency command, and superposition of main and auxiliary frequency commands.

8.2.1 Selection of main frequency command source

Set parameter F0.02 to select the input of the main frequency command. There are 9 types of main frequency commands of the inverter .

function code	name	default value	Predetermined area	Parameter Description
F0.02	Main frequency source selection	0	0	digital setting
			1	AI1
			2	AI2
			3	reserve
			4	reserve
			5	multi-segment command
			6	Simple PLC
			7	closed-loop PID
			8	Communication given frequency

8.2.2 Operation panel to set main frequency (digital setting)

There are four situations when setting the main frequency with the operation panel and performing frequency correction based on the UP and DOWN functions:

- The unit digit of F0.13 is 0 (no memory after power failure) , that is, the set frequency value will return to the set value of the digital setting (F0.05) after the inverter stops or is powered on again after power failure .
- The unit digit of F0.13 is 1 (power-off memory) , that is, when the inverter is powered on again after power-off, the set frequency is the frequency setting value at the time of last power-off .
- The tens place of F0.13 is 1 (the stop frequency returns to the initial value), set the digital frequency of F0.05 with the panel, and then use the up and down keys on the keyboard or terminals UP and DOWN

to correct the frequency, and the frequency is corrected after the inverter stops. The value is cleared to zero.

- The tens place of F0.13 is 0 (the stop frequency is maintained), set the digital frequency of F0.05 with the panel, and then correct the frequency through the up and down keys of the keyboard or terminals UP and DOWN, and the frequency correction value after the inverter stops is reserved.

function code	name	default value	Predetermined area	Parameter Description
F0.05	digital setting	50.00Hz	F0.09 ~ F0.08	-
F0.07	output frequency	50.00Hz	F0.08 ~ 600.00Hz	-
F0.08	frequency cap	50.00Hz	F0.09 ~ F0.07	-
F0.09	Operating frequency lower limit	0.00Hz	0.00Hz ~ F0.08	-
F0.13	UP/ DN adjustment control	0x0000	0x0000 ~ 0x1111	Ones place: After the panel UP/DN modifies the frequency 0: The frequency is not stored when power off 1: frequency power-down storage Tens digit: After the panel UP/DN modifies the frequency 0: Keep the stop frequency 1: Shutdown frequency restores to initial value Hundreds place: After the terminal UP/DN modifies the frequency 0: The frequency is not stored when power off 1: frequency power-down storage Thousands digit: after terminal UP/DN modifies the frequency 0: Keep the stop frequency 1: Shutdown frequency restores to initial value

8.2.3 Analog quantity setting main frequency (A1 , A12 setting)

Set the main frequency through the analog input AI1, AI2, each AI terminal can set the corresponding AI curve, the specific setting steps are as follows:

setup steps	Related parameters	illustrate
(Step 1) AI terminal as a frequency source: Select the AI input terminal of the frequency command according to the terminal characteristics	F0.02	Main frequency selection: F 0.02=1: AI1 terminal input to set the main frequency F 0.02=2: AI2 terminal input to set the main frequency
(Step 2) AI curve setting method: set the corresponding relationship between the input of AI voltage/current and the set value	F5.27~F5.30 F5.31 ~F5.34	Curve 1 setting Curve 2 setting
(Step 3) Set filter time	F5.23 ~F5.24	A I1 , A I2 filter time

- AI curve setting method:

There are 2 types of AI curves, among which, curve 1 corresponds to AI1, and curve 2 corresponds to AI2, both of which are 2-point curves, and the relevant parameters are F5.27 ~ F5.34.

function code	name	default value	Predetermined area	Parameter Description
F5.27	Minimum setting of AI1 curve	0.00V	0.00V~F5.29	100.0 % is the percentage relative to the maximum frequency F 0.07
F5.28	Corresponding setting of AI1 curve minimum reference	0.0%	(-100.0 ~ +100.0) %	
F5.29	AI1 curve maximum setting	10.00V	F5.27 ~ +11.00V	
F5.30	Corresponding setting of AI1 curve maximum given	100.00%	(-100.0 ~ +100.0) %	
F5.31	Minimum setting of AI2 curve	0.00V	0.00V~F5. 33	

function code	name	default value	Predetermined area	Parameter Description
F5.32	Ai2 curve minimum given corresponding setting	0.0%	(-100.0 ~ +100.0)%	100.0% is the percentage relative to the maximum frequency F 0.07
F5.33	Ai2 curve maximum setting	10.00V	F5.31~+11.00V	
F5.34	Corresponding setting of AI2 curve maximum given	100.00%	(-100.0 ~ +100.0)%	

The setting of the curve is actually to set the relationship between the analog input voltage (or analog input current) and the set frequency it represents. When AI is used as frequency setting, 100.0% of the corresponding setting of voltage or current input refers to the relative (maximum output frequency F0.07) percentage. The 2-point curve takes the AI1 curve as an example, and the detailed parameters and descriptions are as follows (the method of the AI2 curve is the same):

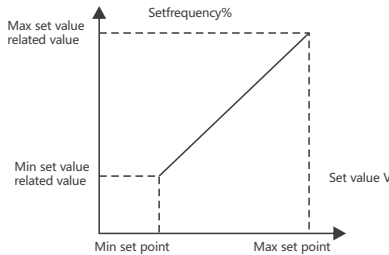

Figure 8-2-1 AI curve 1 setting

• AI curve filter selection:

The larger the input filter time of input terminal AI, the stronger the anti-interference ability, but the slower the adjustment response; the smaller the filter time, the faster the adjustment response, but the weaker anti-interference ability.

function code	name	default value	Predetermined area	Parameter Description
F5.23	Ai1 filter	0.05 s	(0.00~10.00)s	
F5.24	Ai2 filtering	0.05 s	(0.00~10.00)s	-

8.2.4 Multi-segment command setting main frequency

NVF2G-S can set up to 15 operating frequencies, which can be selected through the arrangement and combination of 4 X terminals. can also be less than

The 4 X terminals are used for multi-stage frequency reference, and the missing setting bits are calculated according to state 0.

When the command is a multi-segment command, the X terminal function selection should be set to the function value of 24~27, that is, the multi-segment frequency command input terminal is specified, and the required multi-segment frequency is set through the multi-segment frequency table of the FA group. The parameters are as follows:

function code	name	default value	Predetermined area	Parameter Description
F5.01	X1 terminal function	1	0~ 63	24: Multi-segment command terminal 1
F5.02	X2 terminal function	2		25: Multi-segment command terminal 2
F5.03	X3 terminal function	9		26: multi-segment command terminal 3
F5.04	X4 terminal function	12		27: multi-segment command terminal 4
F5.05	X5 terminal function	0		
F5.06	X6 terminal function	0		

multi- stage instruction is relative value, which is the percentage of relative maximum frequency F0.07. The positive or negative of the parameter determines the running direction, if it is negative, it means the inverter runs in the opposite direction.

4 X terminals are selected as the signal input terminals K1~K4 for multi-segment frequency designation, and they are sequentially formed into 4-bit binary numbers: 1 means that the setting function of the X terminal is valid, and 0 means that the setting function of the X terminal is invalid.

According to the state, it can be combined into 15 states, and these 15 states correspond to 15 command setting values. The details are shown in the following table:

K4	K3	K2	K1	command setting	Corresponding parameters	Predetermined area	Remark
0	0	0	1	Multi-band frequency 1	FA.31	(-100.0 ~ +100.0) %	100 % is the percentage relative to the maximum frequency (F 0.0 7), the positive or negative of the parameter determines the running direction, and the negative value means running in the opposite direction
0	0	1	0	Multi-band frequency 2	FA.31	(-100.0 ~ +100.0) %	
0	0	1	1	Multi-band frequency 3	FA.33	(-100.0 ~ +100.0) %	
0	1	0	0	Multi-band frequency 4	FA.34	(-100.0 ~ +100.0) %	
0	1	0	1	Multi-band frequency 5	FA.35	(-100.0 ~ +100.0) %	
0	1	1	0	Multi-band frequency 6	FA.36	(-100.0 ~ +100.0) %	
0	1	1	1	Multi-band frequency 7	FA.37	(-100.0 ~ +100.0) %	
1	0	0	0	Multi-band frequency 8	FA.38	(-100.0 ~ +100.0) %	
1	0	0	1	Multi-band frequency 9	FA.39	(-100.0 ~ +100.0) %	
1	0	1	0	Multi-band frequency 10	FA.40	(-100.0 ~ +100.0) %	
1	0	1	1	Multi-band frequency 11	FA.41	(-100.0 ~ +100.0) %	
1	1	0	0	Multi-band frequency 12	FA.42	(-100.0 ~ +100.0) %	
1	1	0	1	Multi-band frequency 13	FA.43	(-100.0 ~ +100.0) %	
1	1	1	0	Multi-band frequency 14	FA.44	(-100.0 ~ +100.0) %	
1	1	1	1	Multi-band frequency 15	FA.45	(-100.0 ~ +100.0) %	

8.2.5 Set main frequency through simple PLC

When the simple PLC is used as the main frequency, set FA.00 to select the operation mode of the simple PLC, whether to remember the operating stage and operating frequency of the PLC before power failure after power failure or shutdown:

function code	name	default value	Predetermined area	Parameter Description
FA.00	Simple PLC operation mode selection	0x0000	0x0000 ~ 0x1112	Everyone: PLC operation mode 0: Stop after a single cycle 1: Keep the final value after a single loop 2: continuous loop Tens place: downtime storage 0: do not store 1: Store downtime phase, frequency Hundreds place: power-off storage 0: do not store 1: Store power-off time stage, frequency Thousands: stage time unit selection 0: seconds 1 point

When the operating frequency of the simple PLC is selected to be given by the multi-segment frequency N (the unit digit of FA.01 is 0), it is necessary to set the parameter FA.31 ~ FA.45, FA.01 ~ FA.30 set the running time, acceleration and deceleration time and running direction of each segment;

function code	name	default value	Predetermined area	Parameter Description
FA.01	Phase 1 Setup	0x0000	0x0000 ~ 0x0315	
FA.02	Phase 1 run time	2 0.0	0.0 ~ 6500.0	
FA.03	Phase 2 Setup	0x0000	Same as FA.01	
FA.04	Phase 2 runtime	2 0.0	0.0 ~ 6500.0	
FA.05	Phase 3 Setup	0x0000	Same as FA.01	
FA.06	Phase 3 run time	2 0.0	0.0 ~ 6500.0	
FA.07	Phase 4 Setup	0x0000	Same as FA.01	
FA.08	Phase 4 runtime	2 0.0	0.0 ~ 6500.0	
FA.09	Stage 5 Setup	0x0000	Same as FA.01	
FA.10	Phase 5 run time	2 0.0	0.0 ~ 6500.0	
FA.11	Stage 6 Setup	0x0000	Same as FA.01	
FA.12	Phase 6 run time	2 0.0	0.0 ~ 6500.0	
FA.13	Stage 7 Setup	0x0000	Same as FA.01	
FA.14	Phase 7 run time	2 0.0	0.0 ~ 6500.0	
FA.15	Stage 8 Setup	0x0000	Same as FA.01	
FA.16	Phase 8 runtime	2 0.0	0.0 ~ 6500.0	
FA.17	Stage 9 Setup	0x0000	Same as FA.01	
FA.18	Phase 9 run time	2 0.0	0.0 ~ 6500.0	
FA.19	Stage 10 Setup	0x0000	Same as FA.01	
FA.20	Stage 10 run time	2 0.0	0.0 ~ 6500.0	
FA.21	Stage 11 Setup	0x0000	Same as FA.01	
FA.22	Phase 11 Runtime	2 0.0	0.0 ~ 6500.0	
FA.23	Stage 12 Setup	0x0000	Same as FA.01	
FA.24	Phase 12 Runtime	2 0.0	0.0 ~ 6500.0	
FA.25	Stage 13 Setup	0x0000	Same as FA.01	
FA.26	Phase 13 run time	2 0.0	0.0 ~ 6500.0	
FA.27	Stage 14 Setup	0x0000	Same as FA.01	
FA.28	Phase 14 Runtime	2 0.0	0.0 ~ 6500.0	
FA.29	Phase 1 5 Setup	0x0000	Same as FA.01	
FA.30	Stage 15 run time	2 0.0	0.0 ~ 6500.0	

Units: frequency source
 0: multi-band frequency N
 1-5: Reserved
 Tens place: running direction
 0: Forward rotation
 1: reverse
 Hundreds place: Acceleration and deceleration time
 0: Acceleration and deceleration time 1
 1: Acceleration and deceleration time 2
 2: Acceleration and deceleration time 3
 3: Acceleration and deceleration time 4

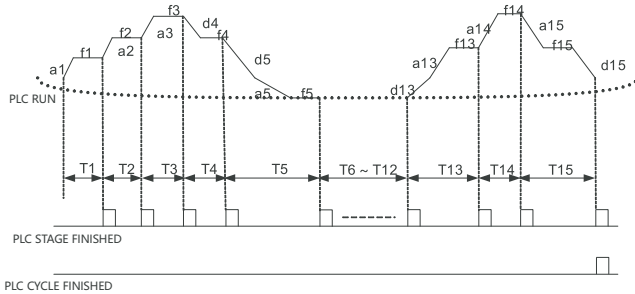

Figure 8-2-3 Schematic diagram of simple PLC as main frequency

the simple PLC function of the inverter includes 3 types: stop after a single cycle, maintain the final value after a single cycle, and continuous cycle . Show:

- Shutdown after a single loop:

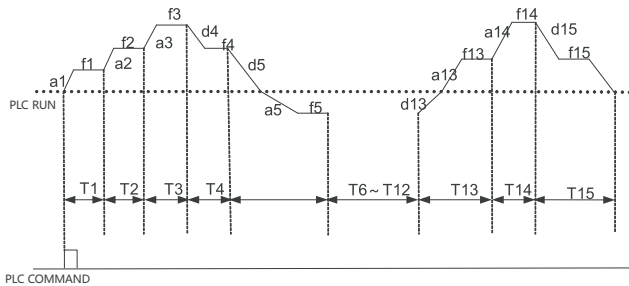

Figure 8-2-4 Simple PLC stop mode after single cycle

- Hold final value after single loop:

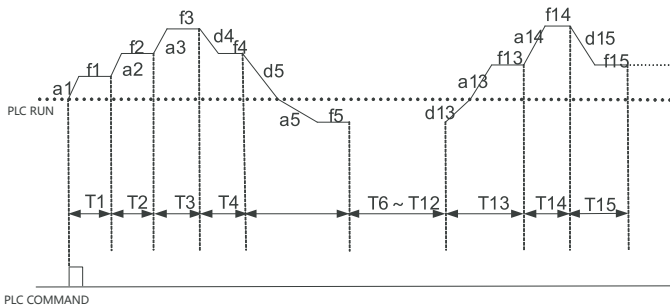

Figure 8-2-5 Simple PLC keeps the final value after a single cycle

- Continuous loop:

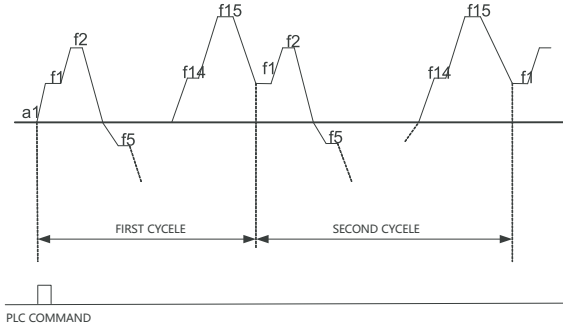

Figure 8 -2-6 Simple PLC continuous cycle mode

8.2.6 Process PID setting main frequency

Process PID control is a common method of process control. By performing proportional, integral and differential operations on the difference between the feedback signal of the controlled quantity and the target signal, the output frequency of the inverter is adjusted to form a closed-loop system to stabilize the controlled quantity, at target value;

When the system uses closed-loop PID as the command input, if the terminal is set to disable PID (terminal function 44), the system will switch to the F9.29 standby channel for adjustment.

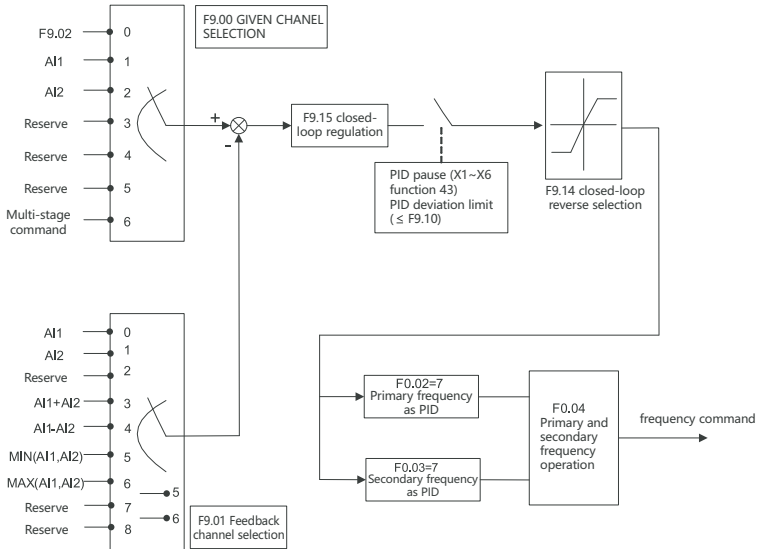
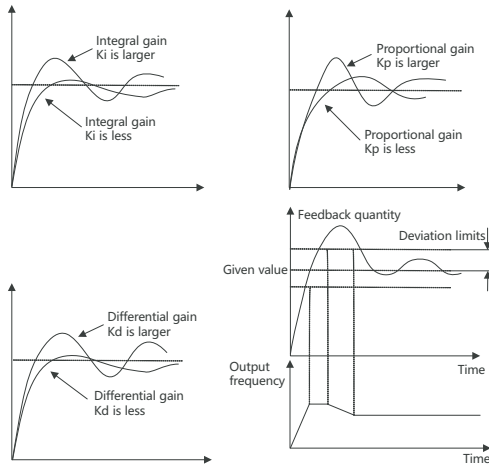

Figure 8 -2-7 Schematic diagram of process PID as the main frequency



function code	name	default value	Predetermined area	Parameter Description
F9.00	given channel selection	1	0~6	0: digital given 1: AI1 2: AI2 3: reserved 4: reserved 5: reserved 6: Multi-stage speed setting
F9.01	Feedback Channel Selection	1	0~6	0: AI1 1: AI2 2: reserved
F9.02	Given quantity digital setting	50.0%	(0.0~100.0)%	
F9.03	Proportional gain Kp	20.0	0.0~100.0	
F9.04	Integral gain	2.00	0.01~10.00	
F9.05	differential gain	0.000	0.0000~ 10.000	
F9.06	The sampling period	0.50s	(0.01~50.00) s	
F9.07	given change time	0.00s	(0.00~650.00)s	
F9.08	Feedback filter time	0.00s	(0.00~60.00)s	
F9.09	output filter time	0.00s	(0.00~60.00)s	
F9.10	deviation limit	0.0%	(0.0~100.0)%	
F9.11	differential clipping	0.10%	(0.0~100.0)%	
F9.12	Maximum positive deviation between two outputs	1.00%	(0.0~100.0)%	
F9.13	Maximum reverse deviation between two outputs	1.00%	(0.0~100.0)%	
F9.14	Closed-loop output reversal selection	0	0 ~1	0: The closed-loop output is negative, and the inverter runs at the lower limit frequency 1: The closed-loop output is negative, and the inverter runs in reverse
F9.15	Closed-loop regulation characteristics	0	0 ~1	0: positive direction 1: Reverse direction
F9.16	Integral adjustment characteristics	0	0 ~1	0: stop integration when the frequency reaches the upper and lower limits 1: When the frequency reaches the upper and lower limits, continue to integrate
F9.23	Closed-loop preset initial value	0.0%	(0.0 ~100.0)%	
F9.24	Preset initial value hold time	0.00s	(0.00 ~650.00)%	
F9.25	Given feedback range	1000	0 ~65535	
F9.26	Feedback loss detection value	0.0%	(0.0 ~100.0)%	
F9.27	loss detection time	0.0	(0.0 ~20.0)%	
F9.28	Closed loop operation mode	0	0~1	0: no operation when stopped 1: Computing at shutdown
F9.29	Closed Loop Alternate Channel Selection	0	0~4	0: digital setting 1: AI1 2: AI2 3: reserved 4: reserved

Figure 8-2-8 Influence of Process PID Parameters

8.2.7 Communication setting main frequency

See Chapter 9 RS485- Modbus communication instructions for details .

8.2.8 Input setting of auxiliary frequency command

Set parameter F0.03 to select the auxiliary frequency command input, which is the same as the main frequency command input selection method, the specific parameter selection and setting process can refer to "8.2.1 Select the input method of the main frequency command".

function code	name	default value	Predetermined area	Parameter Description
F0.03	Auxiliary frequency source selection	0	0	Digital setting (F 0.05)
			1	A I1
			2	A I2
			3	reserve
			4	reserve
			5	multi-segment command
			6	Simple PLC
			7	Closed-loop PLC
			8	Communication given frequency

8.2.9 Select main and auxiliary frequency superposition command

The relationship between the target frequency and the main and auxiliary frequency commands can be set by parameter F 0 . 04 .

function code	name	default value	Predetermined area	Parameter Description
F0.04	Main and auxiliary frequency source operation	0x0000	0x0000 ~0x0031	Units: frequency source selection 0: main frequency selection 1: operation result Tens place: main and auxiliary frequency source operation 0: main + auxiliary 1: main + auxiliary 2: The maximum value of the two is MAX 3: The minimum value of both MIN

8.2.1 0 frequency command limit (frequency setting)

Operating frequency upper limit: limit the maximum output frequency, and the motor is not allowed to run above a certain frequency;

Lower limit of operating frequency: limit the minimum output frequency, and do not allow the motor to run below a certain frequency;

Maximum output frequency: limit the maximum output frequency.

function code	name	default value	Predetermined area	Parameter Description
F0.07	output frequency	50.00Hz	F0.08~600.00Hz	
F0.08	frequency cap	50.00Hz	F0.09~F0.07	
F0.09	Operating frequency lower limit	0.00Hz	0.00Hz~F0.08	

8.3 Start and stop method setting

8.3.1 Start method

There are three starting methods for the inverter, which are: start from the starting frequency , brake first and then start from the starting frequency, and start after speed tracking . Set parameter F1.00 to select the starting method of the inverter .

function code	name	default value	Predetermined area	Parameter Description
F1.00	Starting mode	0	0~2	0 Start from the starting frequency 1 Brake first and then start from the starting frequency 2 speed tracking (including direction judgment) restart
F1.01	Starting frequency	0.00Hz	(0.00 ~ 10.00) Hz	
F1.02	Starting frequency hold time	0.0s	(0.0 ~100.0)s	
F1.03	DC braking time before starting	0.0 %	(0.0 ~ 100.0) %	1 00 % (inverter rated current)
F1.04	DC braking time before starting	0.0s	(0.0 ~ 100.0) s	

- Start from the starting frequency

Set parameter F1.00=0, the inverter will start directly, which is suitable for most loads. Add F1.01 before starting to start the frequency of direct start : when using elevators , hoisting and other lifting loads.

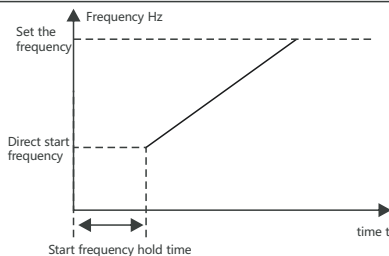
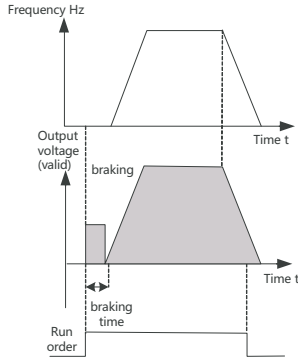

Figure 8 -3-1 Timing diagram of direct start

- Brake first and then start from the starting frequency

Set F1.00=1, add F1.01~F1.04 before starting. The DC braking function is suitable for the occasion where the motor rotates when starting.

Figure 8-3-2 Sequence diagram of braking first and then starting

- Speed tracking (including direction discrimination) restart

Set F1.00=2, the inverter will start after speed tracking (the inverter first judges the speed and direction of the motor, and then starts with the tracked motor frequency). It is suitable for driving large inertial mechanical loads. If the load motor is still running by inertia when the inverter starts running, the speed tracking and restarting can avoid the occurrence of overcurrent at startup.

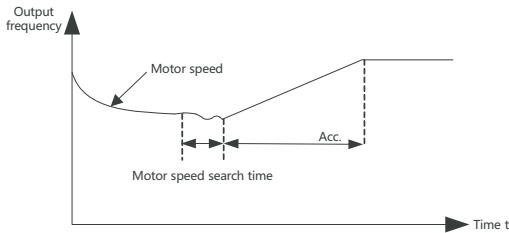
Figure 8-3-3 Sequence diagram of speed tracking restart

8.3.2 Shutdown mode

The frequency converter has three stop modes, which are deceleration stop, free stop and deceleration stop + DC braking. Set parameter F1.05 to select the stop mode of the inverter.

function code	name	default value	Predetermined area	Parameter Description
F1.05	Shutdown mode	0	0~2	0: decelerate to stop 1: free stop 2: Deceleration to stop + DC braking
F1.06	Start frequency of DC braking at stop	0.00Hz	0.00Hz ~ F0.07	--
F1.07	Stop DC braking waiting time	0.0s	(0.0~100.0)s	--
F1.08	Stop DC brake current	0.0%	(0.0~100.0)%	100% (inverter rated current)
F1.09	Stop DC braking time	0.0s	(0.0~100.0)s	--

- Deceleration stop

Set F1.05=0, the inverter decelerates to stop. After the stop command is valid, the inverter reduces the output frequency according to the deceleration time, and stops after the frequency drops to 0.

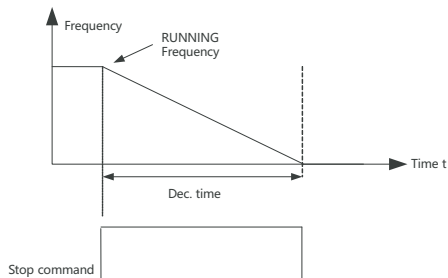

Figure 8-3-4 Sequence diagram of deceleration and stop

- free stop

Set F1.05=1, the inverter coasts to stop. After the stop command is valid, the frequency converter stops output immediately, and the motor stops freely according to the mechanical inertia.

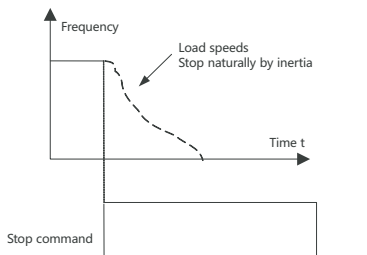

Figure 8-3-5 Free stop timing diagram

- Deceleration to stop + DC braking

Set F1.05=2, the inverter decelerates to stop, and after the frequency drops to the starting frequency of F1.06 DC braking at stop, the inverter starts DC braking.

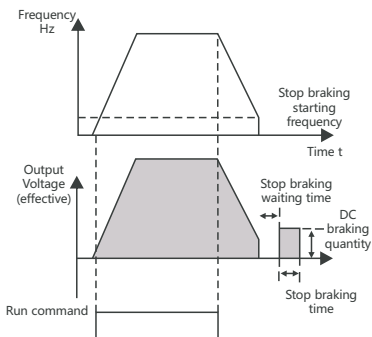

Figure 8-3-6 Sequence diagram of deceleration stop + DC braking

8.3.3 Acceleration and deceleration time and curve setting

Acceleration time refers to the time required for the inverter to accelerate from zero frequency to the maximum output frequency of F0.07; deceleration time refers to the time required for the inverter to decelerate from the maximum output frequency of F0.07 to zero frequency.

- Linear acceleration and deceleration

NVF2G-S provides 4 groups of acceleration and deceleration time, which can be switched and selected by digital input terminal X. For example: select X1 and X2 as the input switching terminals, and form 2-digit binary numbers in turn (where 1 means that the setting function of the X terminal is valid, and 0 means that the setting function of the X terminal is invalid).

function code	name	set value	Predetermined area	Parameter Description
F5.01	X1 terminal function selection	28	0~63	28 : Acceleration and deceleration time selection terminals
F5.02	X2 terminal function selection	29	0~63	29 : Acceleration and deceleration time selection terminal

X2 terminal	X1 terminal	Acceleration and deceleration time curve
0	0	The first group: F 0.14 , F0.15
0	1	The second group: F 8.04 , F 8.05
1	0	The third group: F 8.06 , F 8.07
1	1	The fourth group: F 8.08 , F 8.09

function code	name	default value	Predetermined area	Parameter Description
F0.14	Acceleration time 1	Model confirmed	(0.0 ~ 6500.0) s	--
F0.15	Deceleration time 1	Model confirmed	(0.0 ~ 6500.0) s	--
F8.04	Acceleration time 2	Model confirmed	(0.0 ~ 6500.0) s	--
F8.05	Deceleration time 2	Model confirmed	(0.0 ~ 6500.0) s	--
F8.06	Acceleration time 3	Model confirmed	(0.0 ~ 6500.0) s	--
F8.07	Deceleration time 3	Model confirmed	(0.0 ~ 6500.0) s	--
F8.08	Acceleration time 4	Model confirmed	(0.0 ~ 6500.0) s	--
F8.09	Deceleration time 4	Model confirmed	(0.0 ~ 6500.0) s	--

8.4 Motor parameter self-learning

Motor parameter self-learning is the process for the inverter to obtain the parameters of the controlled motor. The self-learning methods include: static self-learning and dynamic self-learning.

function code	name	default value	Predetermined area	Parameter Description
F2.22	Motor parameter self-learning	0	0~ 2	0: no operation 1: Motor static self-learning 2: Motor dynamic self-learning
F2.00	Motor Type Selection	0	0~ 2	0: Ordinary asynchronous motor 1: reserved 2: reserved
F2.01	Motor rated power	Model confirmed	(0.1 ~ 1000.0) kW	
F2.02	Motor rated voltage	Model confirmed	1V ~ inverter rated voltage	
F2.03	Motor rated current	Model confirmed	(0.01 ~ 600.00)A (inverter power <= 55kW) (0.1 ~ 6000.0)A (inverter power > 55kW)	
F2.04	Motor rated frequency	Model confirmed	0.01 ~ F0.07	

function code	name	default value	Predetermined area	Parameter Description
F2.05	Number of motor poles	Model confirmed	2 ~24	
F2.06	Motor rated speed	1 430 rpm	(0~ 65535)rpm	
F2.07	Asynchronous motor stator resistance	Tuning parameters	(0.001~63.535) Ω (inverter power ≤ 55kW) (0.0001~6.5535) Ω (inverter power > 55k W)	
F2.08	Asynchronous motor rotor resistance	Tuning parameters	(0.001~63.535) Ω (inverter power ≤ 55kW) (0.0001~6.5535) Ω (inverter power > 55k W)	
F2.09	Asynchronous motor leakage inductance	Tuning parameters	(0.001~63.535) Ω (inverter power ≤ 55kW) (0.0001~6.5535) Ω (inverter power > 55k W)	
F2.10	Mutual inductance reactance of asynchronous motor	Tuning parameters	(0.1~6553.5) mH (inverter power ≤ 55kW) (0.01~655.35) m H (inverter power > 55k W)	
F2.11	Asynchronous motor no-load current	Tuning parameters	0.01A~F2.03 (inverter power ≤ 55kW) 0.1A~F2.03 (inverter power > 55 kW)	

- Motor static self-learning: suitable for occasions where it is difficult to separate the motor from the load and dynamic tuning operation is not allowed
 1. Accurately input the motor nameplate parameters: F2.00 ~ F2.06;
 2. Write parameter F2.22 as 1, then press Run to run the inverter;
 3. The words " -TUN-" appear on the panel, and the learning is completed;
- Motor dynamic self-learning: suitable for occasions where the motor is easily separated from the application system :
 1. Accurately input the motor nameplate parameters: F2.00 ~ F2.06;
 2. Write parameter F2.22 as 2, then press Run to run the inverter ;
 3. The words " -TUN-" appear on the panel, and the learning is completed;

	<p>Notice</p> <ol style="list-style-type: none"> 1. When performing parameter self-learning, the motor parameters must be entered correctly according to the motor nameplate, otherwise the motor parameter self-learning may be inaccurate. 2. During the motor parameter self-learning process, the learning process can be terminated by pressing the STOP button, but it may cause incomplete motor parameter self-learning results. 3. During the self-learning process of the motor parameters, if there is an abnormality, it will report a poor self - tuning fault (E.tE).
---	---

8.5 V/F control parameters

8.5.1 Linear V / F, multi-point V / F, and torque -reducing V / F curves

function code	name	default value	Predetermined area	Parameter Description
F4.00	V / F curve setting	0	0~4	0: Straight line V / F curve 1: 2 power drop torque V / F curve 2 : 1.7 power drop torque V / F curve 3 : 1.2 power drop torque V / F curve 4: Multi-point V / F curve
F4.01	torque boost	Model confirmed	(0.0 ~ 30.0) %	0.0% (automatic torque boost) (0.1 ~ 30.0) % (relative to the rated voltage of the motor)

function code	name	default value	Predetermined area	Parameter Description
F4.02	Torque boost cut-off frequency	5 0.00Hz	0.00Hz ~F0.07	
F4.03	Multipoint V F Frequency Point 3	0.00Hz	F 4.05~F2.04	
F4.04	Multi-point V F voltage point 3	0.0 %	(0.0 ~ 100.0) %	
F4.05	Multipoint V F Frequency Point 2	0.00Hz	F4.07 ~F4.03	
F4.06	Multi-point V F voltage point 2	0.0 %	(0.0 ~ 100.0) %	
F4.07	Multi-point V F frequency point 1	0.00Hz	0.00Hz ~ F4.05	
F4.08	Multi-point V F voltage point 1	0.0 %	(0.0 ~ 100.0) %	

Universal constant torque V/F curve: Below the rated frequency, the output voltage and frequency change linearly, suitable for general mechanical transmission applications such as large inertia fans, punching machines, centrifuges, and water pumps

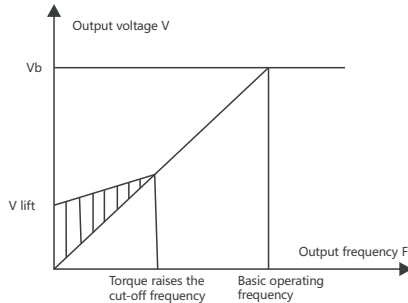

Figure 8-5-1 General constant torque linear V/F curve

- Custom multi-point V/F curve: the frequency point setting range is 0.00Hz to the rated frequency of the motor, the voltage point setting range is 0.0% to 100% corresponding to 0V to the motor rated voltage, and the setting value of the multi-point V/F curve is usually based on The load characteristics of the motor are set.

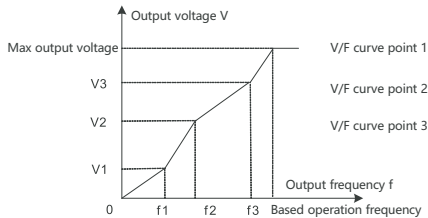
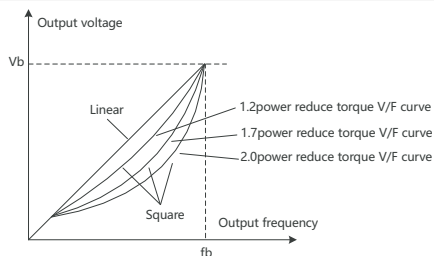

Figure 8-5-2 Custom multi-point V/F curve

- Decreasing torque V/F curve: Below the rated frequency, the relationship between the output voltage and the output frequency changes according to the curves of 2 power, 1.7 power and 1.2 power. This V/F curve is suitable for light load and the load does not change frequently. Fan, water pump load use.

Figure 8 -5-3 V/F Curve of Decreasing Torque

8.6 Vector control

Vector control is speed control: The speed control method is based on the stable speed as the core of the whole control to ensure that the running speed is consistent with the set speed, and the maximum load capacity is limited by the torque limiter.

8.6.1 Vector speed control parameter setting

function code	name	default value	Predetermined area	Parameter Description
F0.00	Motor control method	1	0~1	0: SVC control 1: V/F control
F3.01	Speed Regulator Proportional Gain 1	30	1~100	-
F3.02	Speed regulator integral gain 1	0.5s	(0.01~10.00)s	-
F3.03	Switching frequency 1	5.00Hz	0Hz~F3.06	-
F3.04	Speed Regulator Proportional Gain 2	20	1~100	-
F3.05	Speed regulator integral gain 2	1.00s	(0.01~10.00)s	-
F3.06	Switching frequency 2	10.00Hz	F3.03~F0.07	-
F3.07	SVC slip compensation coefficient	100%	(50~200)%	-

If vector control is used, motor parameter self-learning must be performed first, see 8.4 Motor parameter self-learning.

8.7 Overflow stall protection

During the operation of the inverter, if the current exceeds the overcurrent stall action current (factory value 150% means 1.5 times the rated current of the motor), the overcurrent stall will take effect, and the output frequency will begin to decrease until the current returns below the overcurrent stall point. After that, the frequency starts to accelerate upwards to the target frequency, and the actual acceleration time is automatically lengthened. The larger the overflow stall gain is, the stronger the overflow stall effect is, that is, the faster the output frequency drops.

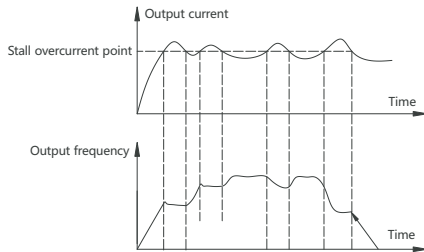
Figure 8 -7-1 Schematic diagram of overflow stall action

function code	name	default value	Predetermined area	Parameter Description
FE.07	Overrun stall gain	1	0~1	0: disabled 1: valid
FE.08	Overcurrent stall protection current	150%	(100~200)%	

8.8 Overvoltage stall suppression

During the operation of the inverter, if the bus voltage exceeds the overvoltage stall protection voltage FE.06, the overvoltage stall will take effect, adjust the output frequency, and the actual deceleration time will be automatically lengthened to avoid trip protection.

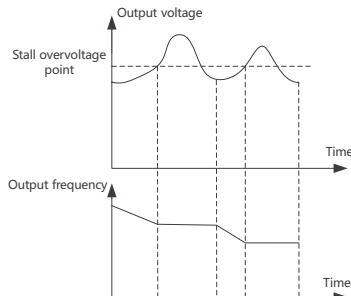
Figure 8 -8-1 Schematic diagram of overvoltage stall action

function code	name	default value	Predetermined area	Parameter Description
FE.05	Overvoltage stall gain	1	0~100	0: disabled
FE.06	Overvoltage stall protection voltage	120%	(120~150)%	

8.9 Protection function

8.9.1 Power - on start-up protection

function code	name	default value	Predetermined area	Parameter Description
F8.31	Boot Protection Selection	1	0~1	0: Startup protection is invalid 1: start protection is valid

The start protection of the inverter can be protected by parameter F8.31 startup protection : if the running command is valid when the inverter is powered on (for example, the terminal running command is in the closed state before power-on), the inverter will not respond to the running command, and must be turned off first. The

run command is canceled once, and the inverter will respond only after the run command becomes valid again.

8.9.2 Motor overload protection

function code	name	default value	Predetermined area	Parameter Description
FE.00	Motor overload protection selection	1	0~1	0: disabled 1: allow
FE.01	Motor overload protection gain	1.00	0.20 ~ 10.00	--
FE.02	Motor overload warning function	00	0~1	0: invalid 1: valid
F E.03	Motor overload warning level	80%	(20 ~ 200)%	--

- Motor overload protection gain

In order to effectively protect the motor under different loads, it is necessary to adjust the motor overload protection gain according to the current output overload capacity

FE.01 is set, the motor overload protection is an inverse time curve.

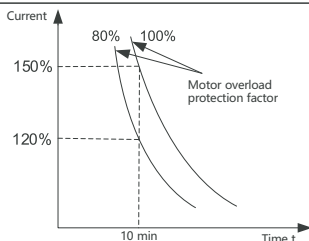

Figure 8-9-1 Schematic diagram of motor overload inverse time curve

Overload protection gain FE.01 is set to 1.00, the default inverse time characteristic of the motor overload protection is: the motor overload will be reported after 10 minutes of continuous operation at 150% of the rated current of the motor; the motor overload will be reported after 80 minutes of continuous operation at 110% of the rated current of the motor.

- Motor overload warning

The motor overload warning function is used to output a warning signal to the control system through DO before the motor overload fault protection. The early warning coefficient is used to determine the degree of early warning before the motor overload protection, the larger the value, the smaller the early warning amount.

When the accumulative output current of the inverter is greater than the product of the overload time (the accumulative value of the inverse time-limit curve of the motor overload protection) and the FE.03 motor overload pre-alarm level, the multi-function digital terminal DO of the inverter outputs a valid signal of the motor overload pre-alarm.

In special cases, when the motor overload warning level FE.03 is set to 100%, the early warning advance amount is 0, and at this time the pre-alarm and overload protection occur simultaneously.

8.9.3 Phase loss protection

function code	name	default value	Predetermined area	Parameter Description
FE.24	Input phase loss detection selection	1	0~2	0: Input phase loss hardware detection 1: Input phase loss software detection 2: Input phase loss software and hardware are not detected
FE.25	Output phase loss detection selection	1	0~2	0: output phase loss software does not detect 1: Output phase loss software

1) Input phase loss setting

On the premise that the R, S, T three-phase AC power supply of the inverter lacks any one phase, select whether the inverter prompts to input a phase loss fault. When the inverter input phase loss protection is selected for software detection, it is necessary to adapt the motor (same as the power level of the frequency converter) with a load of more than 20% of the rated torque, and the input phase loss protection action can be prompted.

2) Output phase loss setting

On the premise that the inverter runs with a motor, when any one of the U, V, W three-phase output of the inverter is missing, select whether the inverter will prompt output phase loss fault.

8.9.4 Load Loss Protection

FE.17=1 The load-off protection is valid, and when the output current of the inverter is less than the load-off detection level FE.18, and the duration is longer than the load-off detection time FE.19, the inverter executes the load-off protection action.

If you choose to continue to run when the load is off, the inverter will automatically resume to run at the set frequency if the load recovers during the load off protection period.

function code	name	default value	Predetermined area	Parameter Description
FE.17	Load Loss Protection Selection	0	0~ 1	0: invalid 1: valid
FE.18	Load drop detection level	10.0%	(0.0~100.0)%	100 % is the rated current of the motor
FE.19	Load drop detection time	1.0s	(0.0~60.0)s	

8.9.5 Fault reset

Fault reset provides two reset methods: manual reset and automatic reset (limited by the number of automatic resets).

- Module failure, overcurrent failure, etc.: automatic reset is not allowed, only manual reset is allowed;
- Undervoltage fault: it will be automatically reset when the bus voltage returns to normal, and it will not be included in the fault automatic reset times;
- Short-circuit fault to ground: It cannot be reset automatically or manually. It can only be reset after the inverter is completely powered off and powered on again.

 Notice	When automatic fault reset is adopted, if the inverter is in running state immediately before the fault occurs, if the number of automatic resets has not been reached: the inverter will automatically reset the fault, and the inverter will continue to run after automatic reset.
--	---

8.9.6 Selection of fault action protection

When the inverter fails, the action state after the fault can be determined by the fault protection action selection function, which can be selected as: free stop after the fault, decelerate to stop after the fault, and continue to run after the fault.

function code	name	default value	Predetermined area	Parameter Description
FE.38	Protection action selection 1 at fault	0x0000	0x0000 ~0x2222	Units: motor overload E .OL1 0: Free parking 1: mode shutdown 2: keep running Tens place: input phase loss E .SPI (same as ones place) Hundreds place: output phase loss E .SPO (same as ones place) Thousands place: external fault E .EF (same as ones place)

function code	name	default value	Predetermined area	Parameter Description
FE.39	Protection action selection 2 at fault	0x0000	0x0000~0x2222	Units: communication abnormality E .CE 0: Free parking 1: Shut down according to the shutdown mode 2: keep running Tens: Reserved Hundreds place: E E prome abnormal E.EEP 0 : free stop 1: Shut down according to the shutdown mode Thousands: reserved
FE.40	Protection action option 3 at fault	0x0000	0x0000~0x2222	Ones place: drop load E.LL 0: Free parking 1 deceleration stop 2: Jump directly to 7% of the rated frequency of the motor to continue running, and automatically return to the set frequency when the load is not lost ID feedback during runtime E .F b L 0: free stop 1: Stop according to the stop mode 2: keep running Hundreds place: excessive speed deviation E d E v (same as tens place) Thousands digit: motor overspeed E.OS (same as tens digit)
FE.41	Protection action selection 4 in case of failure	0x0000	0x0000~0x2222	reserve
FE.42	Protection action option 5 in case of failure	0x0000	0x0000~0x2222	reserve
FE.43	Continue to run frequency selection in case of failure	0	0~4	0: run at the current running frequency 1: Run at the set frequency 2: Run at the upper limit frequency 3: Run at the lower limit frequency 4: Run at the standby frequency when abnormal
FE.44	Exception Alternate Frequency Selection	10.0%	(0.0~100.0)%	(0.0 ~ 100.0) % (corresponding to the maximum frequency)

8.10 Monitoring function

8.10.1 Monitoring parameters

Customers can directly monitor the parameter values of the inverter's running state and standby state through the panel, and can select the state parameters displayed on the panel by setting parameters. The setting of the status display parameters is through the setting method of hexadecimal. Each bit is independent of each other. The value of ones, tens, hundreds and thousands should be set respectively. At this time, the binary value of each bit is determined first, and then the binary Convert the number to hexadecimal. The figure below takes F 7.05 as an example to show the corresponding relationship between LED bits and display parameters, and the specific operations are as follows.

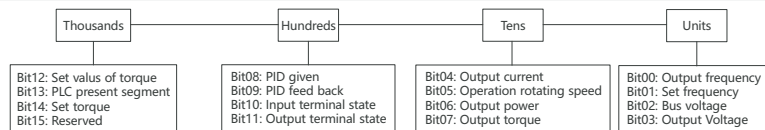

8.10.2 Fd group view status parameter monitoring (read only)

Please refer to the detailed table of parameters in Appendix B.

8. 11 terminal function setting

8.11.1 Digital input terminal function (X)

NVF2G-S series inverters are equipped with 6 multifunctional digital input terminals as standard, and each input terminal can set the following input terminal functions .

function code	name	default value	Predetermined area	Parameter Description
F5.01	X1 terminal function selection	1	0 ~63	See the table below for details
F5.02	X2 terminal function selection	4	0 ~63	
F5.03	X3 terminal function selection	9	0 ~63	
F5.04	X4 terminal function selection	1 2	0 ~63	
F5.05	X5 terminal function selection	0	0 ~63	
F5.06	X6 terminal function selection	0	0 ~63	
F5.07	Valid state setting of input terminal	0x0000	0x0000 ~ 0x001F	
F5.08	Input terminal filter time	0.010s	(0.000 ~ 1.000)s	
F5.11	X1 terminal delay time	0.000s	(0.000 ~ 60.000)s	
F5.12	X2 terminal delay time	0.000s	(0.000 ~ 60.000)s	
F5.13	X3 terminal delay time	0.000s	(0.000 ~ 60.000)s	
F5.14	X4 terminal delay time	0.000s	(0.000 ~ 60.000)s	
F5.15	X5 terminal delay time	0.000s	(0.000 ~ 60.000)s	
F5.16	X6 terminal delay time	0.000s	(0.000 ~ 60.000)s	

X terminal function selection details are as follows:

set value	Function	illustrate
0	no function	Unused terminals can be set as "no function" to prevent misoperation
1	Forward running F WD	Control the forward and reverse rotation of the inverter through external terminals
2	Reverse running R EV	
3	forward jogging	Through the operation control in the control terminal mode, the jogging operation frequency and acceleration and deceleration time are defined in F 8.00~F8.02
4	reverse jogging	
5	Three-wire operation control	of controlling the terminal down, refer to the function introduction in " 8.1 Running command setting "
6	fault reset	which is the same as the fault reset function of the STOP key on the button, and use this function to realize remote fault reset
7	External fault input	The fault signal of the external equipment can be input through this terminal, which is convenient for the inverter to monitor the fault of the external equipment. After the inverter receives the external equipment failure signal, it will display "EEF" , that is, the external equipment failure alarm
9	run pause	The inverter decelerates to stop, and when the terminal is valid, all operating parameters are memorized (such as PLC parameters , P ID parameters); after the terminal is invalid, the inverter resumes the previously memorized operating state
10	External terminal shutdown	This command is valid for all running command channels, and the function terminal is valid to rule that the inverter stops according to the method set by F 1.05 .
12	free parking	Use the control terminal to realize free running stop, which is the same as the function defined in F 1.05
13	Terminal U P	When the frequency source is set to digital setting, when the frequency is modified, it is used as an increment and decrement instruction, and the modification rate is determined by the F 0.12 U P/DN adjustment rate
14	Terminal D OWN	

set value	Function	illustrate
15	command switch to keyboard control	It is used to select different running signal sources, and can switch the inverter running command among keyboard, terminal and communication
16	command switch to terminal control	
17	command to switch to communication control	
18	The main frequency source is switched to digital given	When this function terminal is valid, the main set frequency channel is forced to switch to digital reference, A 11 or A 12
19	The main frequency source is switched to A 11	
20	The main frequency source is switched to A 12	
24	Multi-stage command terminal 1	Through 16 states of these four terminals, 15 - stage speed setting can be realized.
25	Multi-stage instruction terminal 2	
26	Multi-stage instruction terminal 3	
27	Multi-stage command terminal 4	
28	Acceleration and deceleration time selection terminal 1	Through the 4 states of the secondary terminal, the selection of 4 acceleration and deceleration times is realized.
29	Acceleration and deceleration time selection terminal 2	
34	Forward rotation prohibited	Prohibit forward running
35	Reversal prohibited	Prohibition of reverse operation
36	Acceleration and deceleration prohibited	Maintain current output frequency (except stop command)
37	UP /DN setting reset	When the main frequency is set through the panel, the terminal selects this function to clear the frequency value changed by the up and down keys on the keyboard, and restore the given frequency to the setting of F 0.05
43	P ID points suspended	PID is suspended, and the proportional adjustment and differential adjustment are still valid at this time .
44	PID forbidden	P ID function is invalid, if the frequency source is given by closed-loop P ID , the system will switch to F 9.29 channel setting
45	P ID is reversed	P ID is opposite to the direction set by F 9.15
48	DC braking	The inverter directly switches to the DC braking state
49	Frequency setting start terminal	If the terminal is valid, it is allowed to modify the frequency, if the terminal is invalid, it is forbidden to modify the frequency.
51	This run time is cleared	Even if the time is reset to zero when the inverter is running this time,

note: Serial numbers not listed in the table are "reserved".

8.11.2 Digital output terminal function (DO)

NVF2G-S series inverters are equipped with 1 multi-function digital output terminal and 2 multi-function relay output terminals as standard, and each terminal can set the following output terminal functions.

function code	name	default value	Predetermined area	Parameter Description
F6.01	Y1 output function selection	1	0 ~ 63	
F6.02	Relay RO1 output selection	16	0 ~ 63	
F6.03	Relay RO2 output selection	0	0 ~ 63	
F6.04	Valid state setting of output terminal	0x 000 0	0x0000 ~ 0x0007	
F6.05	Y1 output delay time	0.0s	(0.0 ~ 3600.0)s	
F6.06	Relay RO1 output delay time	0.0s	(0.0 ~ 3600.0)s	
F6.07	Relay RO2 output delay time	0.0s	(0.0 ~ 3600.0)s	

The detailed description of DO output terminal function selection is as follows:

set value	Function	illustrate
0	no output	Unused terminals can be set as "no function" to prevent malfunction
1	Inverter running	The frequency converter is in the running state, and the indicator signal is output
2	Frequency Level Detection FDT1 Arrival	Refer to the function description of F6.20 and F6.21
3	Frequency Level Detection FDT2 Arrival	Refer to the function description of F6.22 and F6.23
4	Inverter overload pre-alarm	Inverter is in overload state, output indication signal
5	Brown-out status output	When the DC bus voltage is lower than the undervoltage limit level, an indication signal is output, and the LED displays P.oFF .
6	External fault shutdown	the inverter has an external fault trip alarm " EEF ", it will output an indication signal.
7	Upper limit frequency reached	When the set frequency \geq the upper limit frequency and the running frequency reaches the upper limit frequency, an indication signal will be output.
8	The lower limit frequency is reached	When the set frequency \leq the lower limit frequency and the operating frequency reaches the lower limit frequency, an indication signal will be output.
9	Running at zero speed	When the inverter is running and the output frequency is 0, it will output a valid signal. This signal is invalid when the inverter is in stop state.
15	The drive is ready to run	If the signal output is valid, it means that the inverter has no faults, the bus voltage is normal, the operation prohibition terminal of the inverter is invalid, and the start command can be accepted.
16	Fault output	If the inverter fails, it will output an indication.
19	Torque limited	When the torque command is limited by the driving torque limit value or the braking torque limit value, an indication signal will be output.
20	Speed direction	Indicates the direction of rotation of the motor
22	frequency arrival	When the running frequency of the inverter is within a certain range of the target frequency (target frequency \pm the product of the set value of F6.13 and the maximum frequency), DO outputs a valid signal.
24	Loading	When the frequency converter is in the off-load state, it will output a valid signal.
25	zero current state	When the output current of the inverter is within the range of zero current and the duration exceeds the zero current detection delay time F8.21 , DO outputs a valid signal ; zero current detection range = 0 ~ F8.20 \times F 2.03 (motor rated current) .
26	Arbitrary current reaches 1	When the output current of the inverter is within the range of arbitrary reachable current 1 F8.24 , DO outputs a valid signal ; current detection range = (F8.24 -F8.25) \times F 2.03 (motor rated current) ~ (F8.24 + F8.25) \times F2.03 .
27	Arbitrary current reaches 2	When the output current of the inverter is within the range of arbitrary reach current 2 F8.26 , DO outputs a valid signal ; current detection range = (F8.26 -F8.27) \times F 2.03 (motor rated current) ~ (F8.26 + F8.27) \times F 2.03.
28	Module temperature reaches	the inverter module radiator temperature F d.34 reaches the set module temperature reaching value F8.28 , a valid signal is output.

set value	Function	illustrate
29	Output current exceeded	After the output current of the inverter exceeds the output current limit value of F8.22, and the duration exceeds the output current limit detection delay time F8.23 , DO outputs a valid signal ; output current limit value = F8.22 × F 2.03 (motor rated current) .
31	Motor overload pre-alarm	Before the motor overload protection action, judge according to the overload early warning coefficient FE.03, and output a valid signal after exceeding the pre-alarm threshold.
34	arrive on time	When the timing function selection F8.32 is valid, the inverter will output a valid signal after the current running time reaches the set timing time, and the timing time is set by F8.33.
35	AI1 > AI2	When the value of analog input AI1 is greater than the input value of AI2, a valid signal is output.
37	The current running time is reached	When the accumulative running time of the inverter exceeds the time set by F8.34 current running arrival time, it will output a valid signal.

note: Serial numbers not listed in the table are "reserved"

8.11.3 Analog input terminal function (AI)

NVF2G-S series inverters are equipped with 2 analog input terminals AI1 and AI2 as standard, both of which support 0V ~ +10V, 4mA ~ 20mA command input, and the voltage and current can be realized through the "jumper switch" on the control board. switch. For the method used by the AI channel, please refer to "2.11.4 Setting the main frequency through the analog signal".

8.11.4 Analog output terminal function (AO)

NVF2G-S series inverters are equipped with 2 analog output terminals AO as standard.

function code	name	default value	Predetermined area	Parameter Description
F 6.08	AO1 output function selection	0	0 ~ 36	
F6.09	AO2 output function selection	0	0 ~ 36	
F6.12	AO1 zero offset correction coefficient	0.0%	(-100.0 ~ 100.0)%	
F6.13	AO1 gain	1.00	-10.0. ~ 1 0 . 00	
F6.14	AO2 zero offset correction coefficient	0.0%	(-100.0 ~ 100.0)%	
F6.15	AO 2 gain	1.00	-10.0. ~ 1 0 . 00	

AO terminal function selection details are as follows:

set value	Function	illustrate
0	no function	no function
1	operating frequency	0 ~ maximum output frequency
2	set frequency	0 ~ maximum output frequency
3	Set frequency (after acceleration and deceleration)	0 ~ maximum output frequency
4	output speed	0 ~ maximum speed
5	Output current	0 to 2 times the rated current of the inverter
6	output current 2	0 to 2 times the rated current of the motor
7	Output torque (absolute value)	0 to 3 times the rated torque of the motor
8	Output Power	0 to 2 times the rated power of the motor
9	The output voltage	0 ~ 1.2 times the rated voltage of the inverter
10	bus voltage	(0.0 ~ 1000.0) V
11	AI1	(0 ~ 10)V
12	AI2	(0 ~ 10)V

note: Serial numbers not listed in the table are "reserved".

8.12 Instantaneous power failure continuous operation function (instantaneous power failure non-stop function)

The non-stop function after instantaneous power failure enables the system to continue to operate during short-term power failures.

When a power failure occurs in the system, the frequency converter keeps the motor in power generation state to maintain the bus voltage at FE.16, preventing the frequency converter from shutting down due to short-term input voltage cutoff resulting in undervoltage fault.

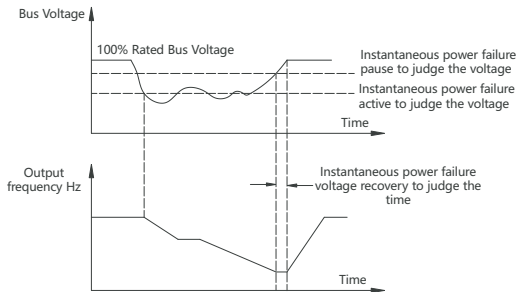

Figure 8-12-1 Schematic diagram of instantaneous stop and non-stop action

function code	name	default value	Predetermined area	Parameter Description
FE.13	Instantaneous power failure action selection	0	0 ~ 2	0: invalid 1: slow down 2: Deceleration to stop
FE.14	Instantaneous operation pause judgment voltage	90.0%	(80.0 ~ 100.0)%	100% is the standard bus voltage
FE.15	Instantaneous power failure voltage recovery judgment time	0.50s	(0.00 ~ 100.00)s	-
FE.16	Instantaneous power failure action judgment voltage	80.0%	(60.0 ~ 100.0)%	100% is the standard bus voltage

- In deceleration mode: when the power grid is restored, the output frequency of the inverter will return to the target frequency according to the acceleration time;
- In deceleration stop mode: When the power grid is restored, the inverter will continue to decelerate to 0Hz to stop, and the inverter will not start until the inverter sends a start command again.

8.13 Jogging operation

In some applications, it is necessary for the inverter to run at a low speed for a short time, which is convenient for testing the condition of the equipment. At this time, jogging operation is used. During jogging operation, the starting mode is fixed as direct start mode F1.00=0, and the stop mode is fixed as deceleration stop mode F1.05=0.

The "MF" key on the operation panel can be used to control the jogging operation (F7.02=0), and the digital input terminal (X) can also be used to realize related functions.

function code	name	default value	Predetermined area	Parameter Description
F5.01	X1 terminal function	1	0 ~ 63	3: forward jogging 4: reverse jogging
F5.02	X2 terminal function	2		
F5.03	X3 terminal function	9		
F5.04	X4 terminal function	12		
F5.05	X5 terminal function	0		
F5.05	X6 terminal function	0		
F8.00	Jog running frequency	5.00Hz	0.10 ~ F0.07	-
F8.01	jogging acceleration time	20.0s	(0.0 ~ 6500.0) s	-
F8.02	jogging deceleration time	20.0s	(0.0 ~ 6500.0) s	-

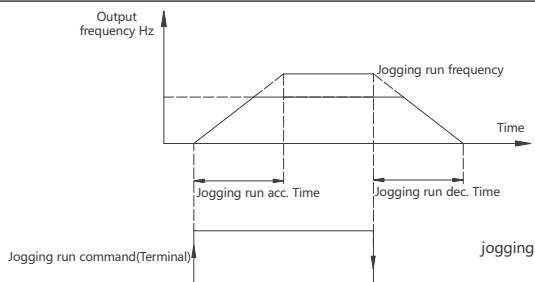
Figure 8-13-1 Schematic diagram of jogging operation

8.14 Skip frequency

By setting the jump frequency, the inverter can avoid the mechanical resonance point of the load. NVF2G-S can set three hopping frequency points, if all hopping frequencies are set to 0, the hopping frequency function will be cancelled.

function code	name	default value	Predetermined area	Parameter Description
F8.10	jump frequency 1	0.00Hz	0.00Hz ~ F0.07	-
F8.11	Hop frequency 1 range	0.00Hz	0.00Hz ~ F0.07	-
F8.12	jump frequency 2	0.00Hz	0.00Hz ~ F0.07	-
F8.13	Hop frequency 2 range	0.00Hz	0.00Hz ~ F0.07	-
F8.14	jump frequency 3	0.00Hz	0.00Hz ~ F0.07	-
F8.15	Hop frequency 3 range	0.00Hz	0.00Hz ~ F0.07	-

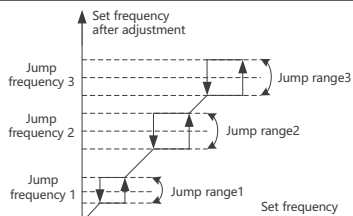
Figure 8-14-1 Schematic diagram of hopping frequency

8.15 Forward and reverse switching

In some occasions, it needs to delay for a period of time when switching between forward and reverse rotation of the motor. At this time, the dead time of forward and reverse rotation can meet the demand.

function code	name	default value	Predetermined area	Parameter Description
F1.10	Forward and reverse dead time	0.0s	(0.0 ~ 300.0)s	-
F1.11	Forward and reverse switching mode	0	0 ~ 1	0:switch at the lower limit of running frequency F0.09 1:switch at starting frequency F1.01

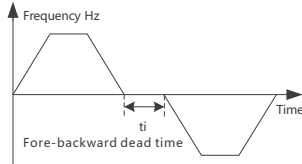
Figure 8-15-1 Schematic diagram of forward and reverse switching

8.16 Dynamic braking

When the motor decelerates, if the load is too large, the deceleration time is too short, etc., the bus voltage of the inverter may rise to the overvoltage level. At this time, on the premise of connecting the braking resistor, the overvoltage fault can be avoided by turning on the dynamic braking.

function code	name	default value	Predetermined area	Parameter Description
F8.16	Action voltage of braking unit	720V (440V series) 360V (230V series)	440V series: (650 ~ 750) V 230V series: (320 ~ 380) V	--
F8.17	Dynamic braking option	0	0 ~ 1	0: no action 1: action
F8.18	Energy consumption braking utilization rate	80.0%	(0.0 ~ 100.0)%	--

8.17 Frequency detection output (FDT)

It is used to set the detection value of the output frequency and the hysteresis value of the release of the output action. The hysteresis value is only valid during the deceleration process, and the detection during the acceleration process does not lag behind.

function code	name	default value	Predetermined area	Parameter Description
F6.20	FDT1 level	50.00Hz	0.00Hz ~ F0.07	-
F6.21	FDT1 hysteresis	5.0%	(0.0 ~ 100.0)%	100% relative to the maximum output frequency
F6.22	FDT2 level	25.00Hz	0.00Hz ~ F0.07	-
F6.23	FDT2 hysteresis	5.0%	(0.0 ~ 100.0)%	100% relative to the maximum output frequency

8.18 Zero current detection

Used to set the zero detection value of the output current.

function code	name	default value	Predetermined area	Parameter Description
F8.20	Zero current detection value	5.0%	(0.0 ~ 300.0)%	--
F8.21	Zero current detection delay time	0.10s	(0.00 ~ 600.00)s	--

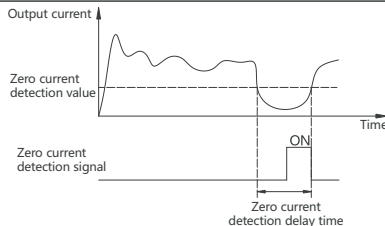
Figure 8-18-1 Schematic diagram of zero current detection

8.19 Timing operation

Every time the inverter is started, it starts timing at 0, and the remaining running time of the timing can be viewed through Fd.49.

function code	name	default value	Predetermined area	Parameter Description
F8.32	Timing function selection	0	0 ~ 1	0: invalid 1: valid
F8.33	Timing run time	0.0min	(0.0 ~ 6500.0) min	-

8.20 Restart after power failure

This function realizes whether the inverter starts running automatically and the waiting time before automatic running under different running command channels after the inverter is powered off.

function code	name	default value	Predetermined area	Parameter Description
F8.35	Power failure restart function selection	0	0 ~ 1	0: invalid 1: Valid
F8.36	Power failure restart waiting time	0.0s	(0.0 ~ 10.0)s	-

8.21 Sleep function

The sleep function is mainly used in water pump water supply, air supply control and other occasions. When the sleep level preset by the user is reached, the inverter can output 0 Hz to maximize energy saving. The sleep function needs to be used in combination with the PID function, and its specific operation process is shown in Figure 8-21-1.

If the sleep function is turned on (set F9.30 to 1, and set F9.28 (closed-loop operation mode) to 1 (operation at shutdown)), the system is in the running state, when the output frequency is detected to be less than or equal to the sleep frequency (F9.31), and the duration reaches the sleep delay time (F9.32), it will automatically enter the sleep state (the inverter runs at 0Hz); when the process closed-loop feedback (Fd.2.9) is less than the process closed-loop reference (Fd.2.8), and the error is greater than the wake-up deviation (F9.33), when the duration reaches the wake-up delay time (F9.34), it will automatically wake up, that is, the system will automatically exit the sleep state and restart operation.

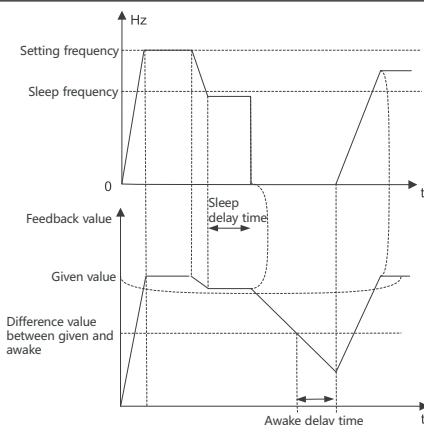

Figure 8-21-1 Schematic diagram of sleep and wake-up

9 RS485-MODBUS communication instructions

9.1 Networking method

The inverter provides RS485 communication interface, and adopts the international standard Modbus communication protocol for master-slave communication. Users can realize centralized control through PC/PLC, host computer monitoring software, etc. (setting inverter control commands, operating frequency, modification of relevant function code parameters, monitoring of inverter working status and fault information, etc.), to adapt to specific application requirements.

As shown in Figure 9-1-1, there are two networking modes of the inverter (as a slave station): single-master / multi - slave mode, single-master / single - slave mode.

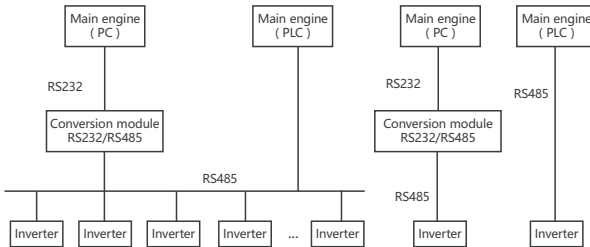

Figure 9- 1 -1 Schematic diagram of inverter networking mode

9.2 Interface

RS485 interface: asynchronous, half-duplex. Default: 8-N-1 (8 data bits, no parity, 1 stop bit), 9600bps , RTU , slave address 0x01 . For parameter setting, see the function code description of Group Fb .

9.3 communication method

- 1) The communication protocol of the inverter is Modbus protocol, which supports RTU and ASCII protocols.
- 2) The frequency converter is a slave machine, master-slave point-to-point communication. When the master uses the broadcast address to send commands, the slave does not respond.
- 3) In the case of multi-machine communication or long-distance, connecting the positive and negative terminals of the signal line of the master station in parallel (100-120) ohm resistance can improve the anti-interference performance of the communication.
- 4) The inverter only provides RS485 interface. If the communication port of the external device is RS232 , an additional RS232/RS485 conversion device is required.

9.4 protocol format

The Modbus protocol supports both RTU mode and ASCII mode, and the corresponding frame format is shown in Figure 3-4-1.

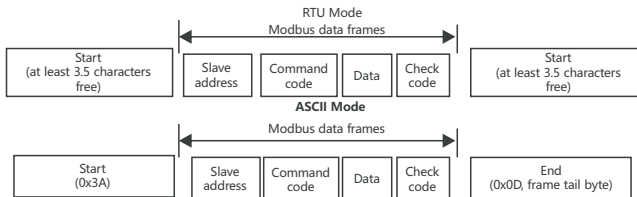

Figure 9- 4 -1 Modbus protocol format

9.4.1 RTU mode

In RTU mode, the idle time between frames takes the larger value between the function code setting and the Modbus internal agreed value. The minimum inter-frame idle time agreed within Modbus is as follows: the frame header and frame tail define the frame through the bus idle time not less than 3.5 bytes. The data verification adopts CRC-16 , the whole information participates in the verification, and the high and low bytes of the checksum need to be exchanged before sending. For specific CRC checks, please refer to the examples at the end of the protocol. It is worth noting that it is enough to keep at least 3.5 characters of bus idle between frames, and the bus idle between frames does not need to accumulate the start and end idle.

The following example is used to read the parameters of the internal register 0x 0101 (F1.01) of slave No.5 in RTU mode.

Request frame:

slave address	command code	data				check code	
		register address	read word count				
0x05	0x03	0x01	0x01	0x00	0x01	0xD5	0xB2

Response frame:

slave address	command code	data			check code	
		response bytes	Register content			
0x05	0x03	0x02	0x00	0X00	0x49	0x84

Wherein, the check code is a CRC check value.

9.4.2 ASCII mode

In ASCII mode, the frame head is "0x3A" , and the frame tail is "0x0D , 0x0A" by default , and the frame tail can also be set by user configuration. In this mode, except for the frame header and frame tail, the rest of the data bytes are all sent in ASCII code, the high 4 -byte group is sent first, and then the low 4 -byte group is sent. The data in ASCII mode is 7 bits long. For "A" ~ "F" , use the ASCII code of the uppercase letters . At this time, the data is verified by LRC , and the verification covers the information part from the slave address to the data. The checksum is equal to the complement of all the characters involved in the checksum (discarding the carry bit).

The following example is used to write 4000 (0xFA0) to internal register 0201 (F 2.01) of slave 5 in ASCII mode.

Request frame:

character	frame header	Slave address		command code		data						check code		end of frame			
						register address	write content										
:	:	0	5	0	6	0	2	0	1	0	F	A	0	4	3	CR	LF
ASCII	3A	30	35	30	36	30	32	30	31	30	46	41	30	34	33	0D	0A

Among them, the check code is the LRC checksum, and its value is equal to the complement of (05+06+02+01+0x0F+0xA0).

Response frame:

character	frame header	Slave address		command code		data						check code		end of frame			
						register address	write content										
:	:	0	5	0	6	0	2	0	1	0	F	A	0	4	3	CR	LF
ASCII	3A	30	35	30	36	30	32	30	31	30	46	41	30	34	33	0D	0A

The inverter can set different response delays through function codes to meet the specific application needs of various master stations. The actual response delay for RTU mode is not less than 3.5 character intervals, and the actual response delay for ASCII mode is not less than 1ms .

9.5 Protocol application

9.5.1 Modbus command code

The main function of Modbus is to read / write the function parameters of the inverter, and different command codes determine different operation requests. The Modbus protocol of the inverter supports the operations in Table 3.1 below.

Table 9.1 Modbus command code and usage

command code	use
0x03	Read inverter parameters, including function code parameters, control parameters and status parameters
0x04	Read the drive parameter attribute value.
0x06	Rewrite a single 16-bit inverter function code parameter or control parameter.
0x10	Rewrite multiple inverter function codes or control parameters.

9.5.2 Inverter function parameter address mapping rules

The group number of the inverter function parameter is mapped to the high byte of the Modbus register address (0~F corresponds to the value 0x00~0x0F), and the group index (that is, the serial number of the parameter in the group) is mapped to the low byte of the Modbus register address (00 ~99 corresponds to 0x00~0x63) , when the data only needs to be saved in RAM (that is, the data will not be saved after power failure), set the highest bit of the address to "1" . For example: modifying the frequency value by communication can be realized by modifying the function parameter F0.05 .

The register address corresponding to the function parameter " F0.05 " (digital setting frequency value) is " 0x0005 ":

- 1) When the data is only stored in RAM , the corresponding address is "0x8005" .
- 2) When the data needs to be saved to EEPROM (save data after power failure), the corresponding address is " 0x0005 " .

Remark:

When the set frequency needs to be modified frequently and the parameter does not need to be saved after power-off, it is recommended to use the first method, that is, only save to RAM, which can prolong the service life of EEPROM.

9.5.3 Get the parameter attribute of the inverter function code

The parameter attribute corresponding to the function code parameter of the inverter can be obtained through the 0x04 command code, and the attribute definition format is shown in Table 9.2 .

Table 9.2 Data format definition when reading parameter properties

data byte	sequence number	meaning
	1	Maximum value (high byte)
	2	Maximum value (low byte)
	3	Minimum value (high byte)
	4	Minimum value (low byte)
	5	Current value (high byte)
	6	Current value value (low byte)
	7	Parameter attribute value (high byte), refer to Table 9.3
	8	Parameter attribute value (low byte), refer to Table 9.3

Table 9.3 Definition of parameter attribute value bit (bit)

bit definition	bit value	decimal value	meaning
15~14bit: display type	00	0	decimal
	01	1	hexadecimal display
	10	2	binary display
13~11bit: Modify attributes	000	0	read and write anytime
	001	1	Can only be modified in the shutdown state
	010	2	read-only parameter
	011	3	Enterprise password is required to read and write
	100	4	Requires corporate password to read
	101	5	Requires user password to read and write

bit definition	bit value	decimal value	meaning
10~8bit: data type	000	0	8 -bit unsigned bit data type
	001	1	16 -bit unsigned bit data type
	010	2	32 -bit unsigned bit data type
	011	3	8 -bit signed data type
	100	4	16 -bit signed data type
	101	5	32 -bit signed data type
7~5bit: magnification	000	0	no magnification
	001	1	1x magnification _
	010	2	magnify 2 times
	011	3	magnify 3 times
	100	4	magnify 4 times
	101	5	magnify 5 times
4~0bit: unit	00000	0	Unitless
	00001	1	Voltage V
	00010	2	Current A
	00011	3	Power kW
	00100	4	Frequency Hz
	00101	5	Frequency kHz
	00110	6	Torque Nm
	00111	7	Speed rpm
	01000	8	time seconds
	01001	9	time milliseconds ms
	01010	10	time microsecond μ s
	01011	11	time minute min
	01100	12	time hour h
	01101	13	percentage%
	01110	14	Weightkg _
	01111	15	Resistance resistance Ω
	10000	16	Inductance mH
	10001	17	temperature $^{\circ}$ C
	10010	18	Pressure value Mp
	10011	19	Length m
	10100	20	centimeter cm
	10101	21	mm mm
	10110	22	Capacity kVA
	10111	23	Linear speedm /min
	11000	24	Mp /s
11001	25	Frequency change rate Hz/s	

Notice

The parameter attribute contains 4 (or 5) 16 -bit data values, and the number of registers must be an integer multiple of 4 (or 5), otherwise the communication feedback illegal register value error.

9.6 Control commands, status information, fault information

The Modbus master station can start, stop, set operating frequency and other operations on the controlled inverter through control commands. Retrieve the state parameter information of the inverter (such as: operating frequency, output current, output torque and other parameters) through corresponding commands, and monitor the fault information of the controlled inverter at the same time.

Table 9.4 Detailed Description of Control Parameters

Function Description	address definition	Data Meaning Description	Power-down save	Read and write properties
Communication control command (communication control when F0.01 = 2)	0x3200	0x00 : no command	no	W
		0x01 : Forward running		
		0x02 : reverse operation		
		0x03 : stop running		
		0x04 : Forward jogging		
		0x05 : reverse jogging		
		0x06 : jogging stop		
		0x07 : free stop		
Inverter status	0x3300	0x08 : fault reset	/	R
		bit00 : run / stop (0 stop, 1 run)		
		bit01 : reverse / forward rotation (0 forward rotation, 1 reverse rotation)		
		bit02 : Zero speed running (1 is valid)		
		bit03 : Accelerating (1 is valid)		
		bit04 : Deceleration in progress (1 is valid)		
		bit05 : Constant speed operation (1 is valid)		
		bit06 : In pre-excitation (1 is valid)		
		bit07 : Tuning in progress (1 is valid)		
		bit08 : overcurrent limit (1 is valid)		
		bit09 : DC overvoltage limiting (1 valid)		
		bit10 : In torque limit (1 is valid)		
		bit11 : In speed limit (1 is valid)		
		bit12 : Inverter fault (1 is valid)		
		bit13 : speed control (1 is valid)		
bit14 : Reserved				
bit15 : undervoltage (0 undervoltage)				
Inverter running state display parameter address	0x3400	Output frequency	/	R
	0x3401	set frequency		
	0x3402	bus voltage		
	0x3403	The output voltage		
	0x3404	Output current		
	0x3405	Operating speed		
	0x3406	Output Power		
	0x3407	output torque		
	0x3408	PID given		
	0x3409	PID feedback		
	0x340A	Input terminal status		
	0x340B	Output terminal state		
	0x340C	reserve		
	0x340D	Analog AI1 value		
	0x340E	Analog AI2 value		
0x340F	reserve			
0x3410	reserve			
0x3411	PLC current segment speed			
Inverter stop state display parameter address	0x3500	set frequency	/	R
	0x3501	bus voltage		
	0x3502	Input terminal status		

Function Description	address definition	Data Meaning Description	Power-down save	Read and write properties
Inverter stop state display parameter address	0x3503	Output terminal state	/	R
	0x3504	PID given value		
	0x3505	PID feedback value		
	0x3506	Torque setpoint		
	0x3507	Analog AI1 value		
	0x3508	Analog AI2 value		
	0x3509	reserve		
	0x350A	reserve		
Inverter fault	0x3600	The fault information is consistent with the fault type serial number in the function code, and what is fed back to the host computer is the hexadecimal data value instead of the fault symbol.	/	R
Communication control command (communication control when F0.01 = 2)	0x3200	0x00 : no command	no	W
		0x01 : Forward running		
		0x02 : reverse operation		
		0x03 : stop running		
		0x04 : Forward jogging		
		0x05 : reverse jogging		
		0x06 : jogging stop		
		0x07 : free stop		
		0x08 : fault reset		
Inverter status	0x3300	bit00 : run / stop (0 stop, 1 run)	/	R
		bit01 : reverse / forward rotation (0 forward rotation, 1 reverse rotation)		
		bit02 : Zero speed running (1 is valid)		
		bit03 : Accelerating (1 is valid)		
		bit04 : Deceleration in progress (1 is valid)		
		bit05 : Constant speed operation (1 is valid)		
		bit06 : In pre-excitation (1 is valid)		
		bit07 : Tuning in progress (1 is valid)		
		bit08 : overcurrent limit (1 is valid)		
		0x09 : DC overvoltage limit (1 is valid)		
		bit10 : In speed limit (1 is valid)		
		bit11 : Reserved		
		bit12 : Inverter fault (1 is valid)		
		bit13 : Operation ready to complete (1 is valid)		
		bit14 : Reserved		
		bit15 : undervoltage (0 undervoltage)		
Inverter running state display parameter address	0x3400	Output frequency	/	R
	0x3401	set frequency		
	0x3402	bus voltage		
	0x3403	The output voltage		
	0x3404	Output current		
	0x3405	Operating speed		
	0x3406	Output Power		
	0x3407	output torque		
	0x3408	PID given		
	0x3409	PID feedback		

Function Description	address definition	Data Meaning Description	Power-down save	Read and write properties
Inverter running state display parameter address	0x340A	Input terminal state	/	R
	0x340B	Output terminal state		
	0x340C	Torque setpoint		
	0x340D	Analog AI1 value		
	0x340E	Analog AI2 value		
	0x340F	reserve		
	0x3410	reserve		
	0x3411	PLC current segment speed		
Inverter stop state display parameter address	0x3412	set speed	/	R
	0x3500	set frequency		
	0x3501	bus voltage		
	0x3502	Input terminal state		
	0x3503	Output terminal state		
	0x3504	PID given value		
	0x3505	PID feedback value		
	0x3506	Torque setpoint		
	0x3507	Analog AI1 value		
	0x3508	Analog AI2 value		
	0x3509	reserve		
Inverter fault	0x350A	reserve	/	R
	0x350 B	set speed		
	0x3600	The fault information is consistent with the fault type serial number in the function code, and what is fed back to the host computer is the hexadecimal data value instead of the fault symbol.		

9.7 Parameter management

The Modbus master station can obtain the group number and group number value of the system parameter from the CPU board through the corresponding command, and obtain the group number of the corresponding group. It is stipulated that the communication function code is "0x03", and the communication address is defined as in Table 9.5 .

Table 9.5 Parameter management function description

Function Description	Mailing address description	data meaning	Remark
Get the number of groups	0x4200	The group value of the parameter contained in the system	Parameter group values contained in the drive
Get the value of the first group number	0x4201	Group number 1 value	The value of the group number is consistent with the value obtained by 0x4200 .
Get the value of the second group number	0x4202	The second group number value	
Get the value of the third group number	0x4203	The third group number value	
...	
Get the value of the Max group number	0x42xx (xx=Max)	The Max group number value	

Function Description	Mailing address description	data meaning	Remark
Get the number of parameters in the group of the first group of parameters	0x4300	Get the number of parameters contained in the first group	The value of the group number is consistent with the value obtained by 0x4200 .
Get the number of parameters in the group of the second group of parameters	0x4301	Get the number of parameters contained in the second group	
Get the number of parameters in the group of the third group of parameters	0x4302	Get the number of parameters contained in the third group	
...	
Get the number of parameters in the Max group of parameters	0x43xx (xx=Max-1)	Get the number of parameters contained in the Max group	

9.8 Wiring Instructions

9.8.1 Topology

No repeater RS-485-Modbus has a trunk cable to which all devices are connected directly (daisy-type) or via short branch cables.

The trunk cable, also known as the bus, can be very long. It must be terminated at both ends. It is also possible to use a repeater between multiple RS-485 Modbus . And the address of each slave address in the network is unique, which is the basis for ensuring Modbus serial communication.

9.8.2 Length

The end-to-end length of trunk cables must be limited. The maximum length is related to baud rate, cable (gauge, capacitance or characteristic impedance), number of loads on the daisy chain, and network configuration (2- wire or 4 -wire).

For cables with a high-speed baud rate of 9600bps and AWG26 (or thicker) specifications, the maximum length is 1000m .

Branches must be short and cannot exceed 20m . If a multi-port splitter with n branches is used, the maximum length of each branch must be limited to 40m divided by n .

9.8.3 Grounding form

" common " circuit (signal and optional power common) must be connected directly to protective ground, preferably at a single point along the entire bus. Typically, this point can be selected on the master or its taps.

9.8.4 Cable

Modbus cable on the serial link must be shielded. At one end of each cable, its shield must be connected to protective earth. If a connector is used at this end, connect the connector housing to the cable shield. RS485 -Modbus must use a balanced pair and a third wire (for common) .

For RS485-Modbus , the cable diameter must be chosen wide enough to allow the use of the maximum length (1000m). AWG24 can meet the needs of Modbus data transmission.

9. 9 Communication exception code definition

When the corresponding error information is detected during the communication process, the lower computer (that is, the CPU board) will set the high position of the function code to "1" and feed back the corresponding error code (abnormal code), so that the upper computer can identify the cause of the current error and respond accordingly The definition is shown in Table 9.6 .

Table 9.6 Definition of communication exception code

serial number	Error code (exception code)	A detailed description
0	0x00	no error message
1	0x01	illegal function number
2	0x02	illegal data address
3	0x03	invalid data value
4	0x04	Slave failure
5	0x05	confirm
6	0x06	slave device busy
7	0x08	storage parity error
8	0x0A	Gateway path is unavailable
9	0x0B	Gateway target device failed to respond
10	0x10	CRC check code error
11	0x11	The parameter is a read-only parameter
12	0x12	data value out of range
13	0x13	EEPROM error
14	0x14	Requires user password to read and write
15	0x15	Enterprise password is required to read and write
16	0x16	The multi-function input terminal has a mutuality error (the setting value of the multi-function input terminal cannot be repeated)
17	0x17	illegal control order
18	0x18	parity error
19	0x19	Cannot be modified in running state
20	0x1A	data frame error
21	0x1B	data overflow error
22	0x1C	Break error

9.10 Example of Modbus communication

Before the communication, first set the relevant communication function parameters, so that the communication address, baud rate, and data format of the upper computer and the lower computer are consistent.

Example1: If it is necessary to change the initial setting frequency of the inverter, change 50.00Hz to 25.00Hz.

Data sent by the host:

<u>01</u>	<u>06</u>	<u>00 05</u>	<u>09 C4</u>	<u>9E 08</u>
Inverter address	write command	parameter address	data content	CRC check

Data received by the host:

<u>01</u>	<u>06</u>	<u>0005</u>	<u>09C4</u>	<u>9E08</u>
Inverter address	write command	parameter address	data content	CRC check

Example 2 : If it is necessary to read the control mode of group F0.00 of the inverter.

Data sent by the host:

<u>01</u>	<u>03</u>	<u>0000</u>	<u>0001</u>	<u>840A</u>
Inverter address	read command	parameter address	Number of data	CRC check

Data received by the host:

<u>01</u>	<u>03</u>	<u>02</u>	<u>0002</u>	<u>3985</u>
Inverter address	read command	number of bytes	data content	CRC check

Example 3 : If the input command exceeds the setting range of function code parameters, take F0.01 (running command channel selection) group as an example, if the input command is 4, which exceeds the

setting range of 0~2, then an error response message will appear.

Data sent by the host:

<u>01</u>	<u>06</u>	<u>0001</u>	<u>0004</u>	<u>D9C9</u>
Inverter address	write command	parameter address	data content	CRC check

Data received by the host:

<u>01</u>	<u>86</u>	<u>12</u>	<u>C26D</u>
Inverter address	error response code	error code	CRC check

 Notice	Common malfunctions	Possible Causes
	1. No response to communication 2. The inverter returns abnormal	1. Serial port selection error 2. The + and - polarities of the RS485 bus are reversed 3. Parameter settings such as baud rate, data bit, and stop bit are inconsistent with the inverter

10 Maintenance and Troubleshooting

10.1 Contents of this chapter

Due to the influence of the temperature, humidity, dust and vibration of the environment, the aging and wear of the components inside the frequency converter, etc., many reasons will lead to potential failures of the frequency converter. Therefore, it is necessary to implement daily and regular maintenance and maintenance of the frequency converter.

Note: Before inspection and maintenance, please confirm the following items first, otherwise there may be a risk of electric shock:

1. The inverter has cut off the power supply;
2. After the cover is opened, the charging indicator light goes out;
3. Use a DC high voltage meter to measure the voltage between the DC busbars to be less than 36V.

10.2 Inspection items

10.2.1 Daily inspection In principle, check whether there is any abnormality during operation:

- 1) Whether the motor runs according to the setting;
- 2) Whether the environment of the installation site is abnormal;
- 3) Whether the cooling system is abnormal;
- 4) Is there any abnormal vibration sound;
- 5) Whether there is overheating and discoloration;
- 6) Use a multimeter to measure the input voltage of the inverter during operation.

10.2.2 Regular inspection

During the regular maintenance and inspection of the inverter, be sure to cut off the power supply, wait for 10 minutes after the monitor (keyboard) has no display and the indicator light of the main circuit power supply is off, and then check the DC bus voltage with a multimeter with DC gear to be less than 36V, so as to avoid damage to the inverter. The residual voltage of the capacitor can injure maintenance personnel.

- 1) Cooling system: Please clean the air filter and check whether the cooling fan is normal.
- 2) Screws and bolts: due to vibration, temperature changes, etc., fixed parts such as screws and bolts may be loose, check whether they are tightened reliably, and please tighten them according to the tightening torque.
- 3) Check whether the conductor and insulator substances are corroded and damaged.
- 4) Measure the insulation resistance.
- 5) Check the filter capacitor for discoloration, peculiar smell, bubbling, leakage, etc.

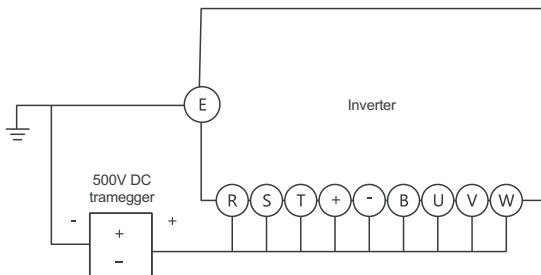

Figure 10.1 Main circuit insulation resistance test

10.3 Routine care and maintenance

The inverter must operate in accordance with the specified operating environment, and some accidents may occur during operation. The user should follow the tips in Table 10.1 to do daily maintenance work. It is a good way to prolong the service life of the inverter to maintain a good operating environment, record the data of daily operation, and find out the cause of the abnormality early.

Table 10.1 Daily inspection reminder list

inspection object	Check essentials			Criterion
	check content	cycle	means of inspection	
operating environment	1. Temperature and humidity	at any time	1. Thermometer , hygrometer	1. (-10~+45) ^o C, (45~55) ^o C derating use
	2. Dust, water and drip		2. Visual inspection	2. No trace of water leakage
	3. Gas		3. Smell	3. No smell
Inverter	1. Vibration, heat	at any time	1. Surgical Touch	1. Stable vibration and reasonable fan temperature
	2. Noise		2. Hearing	2. No abnormal sound
motor	1. Fever	at any time	1. Hand touch	1. There is no abnormality in fever
	2. Noise		2. Hearing	2. Even noise
Running state parameters	1. Output current	at any time	1. Hearing	1. Within the rated range
	2. Output voltage		2. Ammeter	2. Within the rated range
	3. Internal temperature		3. Thermometer	3. Temperature rise is less than 35K

10.4 Regular maintenance

According to the use environment, the user can conduct a regular inspection of the inverter every 3 months or 6 months.

 Notice	<ol style="list-style-type: none"> Only professionally trained personnel can disassemble parts , perform maintenance and replace parts. Do not leave metal parts such as screws and washers in the machine, otherwise there is a risk of damage to the equipment.
--	---

General inspection content:

- If the control terminal screw is loose, tighten it with a screwdriver;
- Whether the main circuit terminals have poor contact, whether there is overheating trace at the copper bar connection;
- Whether the power cables and control cables are damaged, especially whether there are cut marks on the skin in contact with the metal surface;
- Whether the insulating bandages of the power cables have fallen off;
- Fully clean the dust on the circuit board and air duct, it is best to use a vacuum cleaner;
- For the insulation test of the inverter, all input and output terminals (R, S, T, U, V, W, etc.) , otherwise there is a danger of damaging the inverter, please use a 500V megohmmeter;
- If the insulation test is performed on the motor, the input terminals U, V, W of the motor must be disassembled from the inverter, and the motor must be tested separately, otherwise the inverter will be damaged.

 Notice	<ol style="list-style-type: none"> test has been passed before leaving the factory , and the user does not need to perform the withstand voltage test, otherwise the device will be damaged if the test is not done properly . Replacing the original components in the inverter with components with different models and electrical parameters may cause damage to the inverter.
--	--

10.5 Replacement of Vulnerable Parts of the Frequency Converter

Vulnerable parts of frequency converter mainly include cooling fan and electrolytic capacitor for filtering, and their service life is closely related to the environment of use and maintenance status. The general life time is shown in Table 10.2.

Table 10.2 Component life

Device name	life time
fan	(3~ 4) million hours
electrolytic capacitor	(4~ 5) million hours
relay	About 100,000 times

Users can determine the replacement period according to the running time.

- Cooling fan

Possible causes of damage: bearing wear, blade aging.

Judgment criteria: Whether there are cracks in the fan blades, etc., and whether there is abnormal vibration sound when the machine is turned on.

(2) filter electrolytic capacitor

Possible damage reasons: high ambient temperature, frequent load jumps cause increased pulsating current, and electrolyte aging.

Judgment criteria: whether there is liquid leakage, whether the safety valve has protruded, the measurement of electrostatic capacitance, and the measurement of insulation resistance.

(3) Relay

Possible causes of damage: corrosion, frequent movement.

Judgment criteria: open and close failure.

10.6 Troubleshooting

The possible fault types of the inverter are summarized in Table 10.3. Before seeking service, users can conduct self-examination according to the prompts in the table, and record the fault phenomenon in detail. When seeking service, please contact the seller.

Table 10.3 Fault types

error code	Fault type	Possible cause of failure	Countermeasures
E.OC1	Inverter acceleration running over-current	1. The grid voltage is low	Check input power
		2. Direct and quick start during motor rotation	Start the motor after stopping
		3. Acceleration time is too short	Extend acceleration time
		4. Motor parameters are not accurate	Carry out parameter auto-tuning on the motor
		5. When PG is running, the code disc is faulty	Check code wheel and its wiring
		6. The inverter power is too small	Choose a frequency converter with a large power rating
		7. The V/F curve is not suitable	Adjust the V/F curve setting, adjust the manual torque boost
E.OC2	Inverter deceleration running over-current	1. The grid voltage is low	Check input power
		2. The deceleration time is too short	Extend deceleration time
		3. Potential energy load or load inertia torque is large	plus suitable dynamic braking components
		4. When PG is running, the encoder is faulty	Check the encoder and its wiring
		5. The inverter power is too small	Choose a frequency converter with a large power rating
E.OC3	Inverter running at constant speed over-current	1. The acceleration and deceleration time setting is too short	Appropriately extend the acceleration and deceleration time
		2. Load mutation or abnormality	Do a load check
		3. The grid voltage is low	Check input power
		4. When PG is running, the encoder is faulty	Check the encoder and its wiring
		5. The inverter power is too small	Choose a frequency converter with a large power rating
E.OV1	Inverter acceleration operation overvoltage	1. Motor short circuit to ground	Check motor connection
		2. Abnormal input voltage	Check input power
		3. The motor starts quickly again during high-speed rotation	Start the motor after stopping
		4. Acceleration time is too short	Extend acceleration time

error code	Fault type	Possible cause of failure	Countermeasures
E.OV2	Inverter deceleration running over voltage	1. Motor short circuit to ground	Check motor connection
		2. Potential energy load or load inertia torque is large	plus suitable dynamic braking components
		3. The deceleration time is too short	Extend deceleration time
E.OV3	Inverter running at constant speed overvoltage	1. Motor short circuit to ground	Check motor connection
		2. During vector control, the ASR parameter setting is improper	Set appropriate ASR parameters
		3. The acceleration and deceleration time setting is too short	Appropriately extend the acceleration and deceleration time
		4. Abnormal input voltage	Check input power
		5. The input voltage fluctuates abnormally	Install input reactor
		6. Large load inertia	plus suitable dynamic braking components
E.SPI	Input side phase loss	Input RST has phase loss	Check installation wiring Check input voltage
E.SPO	Output side phase loss	Output UVW has phase loss	Check output wiring Check the motor and cables
E.FO	Power Module Protection	1. The three output phases have phase - to-phase short circuit or ground short circuit	Re-wiring, confirm whether the insulation of the motor is good
		2. Instantaneous overcurrent of the inverter	See Overcurrent Countermeasures
		3. The air duct is blocked or the fan is damaged	Unclog the duct or replace the fan
		4. The ambient temperature is too high	reduce ambient temperature
		5. The control board connection or plug-in is loose	Check and reconnect
		6. The current waveform is abnormal due to the lack of output phase	Check wiring
		7. The auxiliary power supply is damaged, and the driving voltage is undervoltage	seek service
		8. Inverter module bridge arm straight through	seek service
		9. The control panel is abnormal	seek service
E.OH1	radiator overheating	1. The ambient temperature is too high	reduce ambient temperature
		2. Duct blockage	Clean up the air duct
		3. The fan is broken	replace the fan
		4. The inverter module is abnormal	seek service
		5. Temperature check circuit failure	seek service
E.OH2	rectifier bridge overheating	1. The ambient temperature is too high	reduce ambient temperature
		2. Duct blockage	Clean up the air duct
		3. The fan is broken	replace the fan
		4. Temperature check circuit failure	seek service
E.OL2	Inverter overload	1. Motor parameters are inaccurate	Carry out motor parameter auto-tuning again
		2. Excessive load	Choose a higher power inverter
		3. The amount of DC braking is too large	Reduce the DC braking current and prolong the braking time
		4. Acceleration time is too short	Extend acceleration time
		5. Grid voltage is too low	Check grid voltage
		6. The V/F curve is not suitable	Correctly set the V/F curve and torque boost

error code	Fault type	Possible cause of failure	Countermeasures
E.OL1	Motor overload	1. The motor overload protection coefficient is not set correctly	Correctly set the motor overload protection coefficient
		2. The motor stalls or the sudden change of load is too large	check load
		3. Long-term low-speed and heavy-load operation of general - purpose motors	Choose a dedicated motor
		4. Grid voltage is too low	Check grid voltage
		5. The V/F curve is not suitable	Correctly set the V/F curve and torque boost
E.EF	External device failure	External fault emergency stop terminal is valid	After the external fault is cancelled, release the external fault terminal
E.EEP	Abnormal EEPROM	An error occurred while reading and writing control parameters	STOP key reset seek service
E.CE	abnormal communication	1. The upper computer is not working properly	Check the upper computer wiring
		2. The communication line is abnormal	Check the communication cable
		3. The communication parameter setting is incorrect	Correctly set communication parameters
E.SHT	Abnormal contactor	1. Grid voltage is too low	Check grid voltage
		2. The contactor is damaged	Replace the main circuit contactor
		3. The power-on snubber resistor is damaged	Replace snubber resistor
		4. The control circuit is damaged	seek service
		5. Input phase loss	Check input RST wiring
E.lTe	Abnormal current detection circuit	1. The control board connection or plug-in is loose	Check and rewire
		2. The auxiliary power supply is damaged	seek service
		3. The Hall device is damaged	
		4. The amplifier circuit is abnormal	
E.tE	Abnormal motor self-learning	1. Motor nameplate parameter setting error	Correctly set the parameters according to the motor nameplate
		2. Perform reverse rotation self-tuning when reverse rotation is prohibited	cancel prohibit reverse
		3. Poor contact of motor connecting wire	Check motor wiring
		4. Self - learning timeout	Check F0.08 (operating frequency upper limit) to see if the set value of F0.08 is lower than the rated frequency
E.Fb L	PID feedback lost at runtime	PID feedback is less than FE .18 set value	Check the PID feedback signal or set FE .18 to a suitable value
E.OS	Motor Overspeed Fault	1. The encoder parameter setting is incorrect	Correctly set the encoder parameters
		2. No parameter identification	Carry out motor parameter identification
		3. Motor overspeed detection parameters FE.20 , FE.21 settings are unreasonable	Set the detection parameters reasonably according to the actual situation
E . dEv	Excessive speed deviation fault	1. The encoder parameter setting is incorrect	Correctly set the encoder parameters
		2. No parameter identification	Carry out motor parameter identification
		3. The setting of detection parameters FE.22 and FE.23 for excessive motor speed deviation is unreasonable	Set the detection parameters reasonably according to the actual situation

error code	Fault type	Possible cause of failure	Countermeasures
E.UV	Undervoltage fault	Grid voltage is low	Check input power
E.OL3	Buffer supply overload	The bus voltage fluctuates up and down at the undervoltage point	seek service
E.StG	Motor to ground short circuit fault	Motor short circuit to ground	Check the motor and cables
E.CbC	Wave-by-wave current limiting fault	1. The load is too large or the motor stalls	Reduce load and check motor condition
		2. The selection of the frequency converter is too small	Choose a frequency converter with a higher power rating
E.INV	Inverter hardware overcurrent fault	Refer to overcurrent fault	Refer to overcurrent fault
E.LL	load drop fault	The operating current of the inverter is less than the set value of FE.18	Check if the load is off
			Set the detection parameters reasonably according to the situation
E.OT	Motor over temperature fault	1. The wiring of the motor temperature sensor is loose	Check motor temperature sensor wiring
		2. Motor temperature is too high	Increase the carrier frequency or take other measures to dissipate heat from the motor

Notice

A short circuit of the braking resistor of the inverter may cause damage to the braking unit of the inverter.

10.7 Operation exception handling

Table 10.4 Operation exception handling methods

Phenomenon	condition	Possible Causes	Countermeasures
The operator panel is not responding	Individual keys or all keys do not respond, or the panel prompts "ErCOC"	The operation panel lock function takes effect	In the state of stopping or running parameters, first press and hold the PRG key, and then continue to press ▼ to unlock Power off the inverter completely and then power on again
		Poor connection of operation panel connection wire	Check the cable and replug it
		The function code cannot be modified	Replace the operation panel or call for service
The function code cannot be modified	Cannot be modified in running state	This function code cannot be modified in the running state	Modify while down
	Some function codes cannot be modified	Function code F7.03 is set to 1 or 2	Change F7.03 to 0
		This function code is the actual detection value	Actual parameters cannot be modified by users
	Press MF no response	The operation panel lock function is in effect or other	See "Operation Panel Not Responding" Solution
Cannot enter after pressing PRG, the function code display status shows 0000	With user password		Enter the user password correctly
			seek service

Phenomenon	condition	Possible Causes	Countermeasures
Inverter stops unexpectedly during operation	If no stop command is given, the inverter will stop automatically, and the running indicator light will be off.	Fault alarm	Find the cause of the fault and reset the fault
		There was a power outage	Check power supply
		run command channel switch	Check the operation and run command channel related function code settings
	If no stop command is given, the motor stops automatically, the inverter running indicator light is on, and it runs at zero frequency	Positive and negative logic changes of control terminals	Check whether the setting of F5.08 meets the requirements
		Fault automatic reset	Check the fault automatic reset setting and the cause of the fault
		External Interrupt	Check external interrupt settings and fault sources
		Set frequency to 0	Check the set frequency
		The starting frequency is greater than the set frequency	Check starting frequency
		Jump frequency setting problem	Check skip frequency settings
		Enable the "forbidden forward running" terminal during forward running	Check terminal function settings
Enable the "reverse running prohibited" terminal during reverse running	Check terminal function settings		
Inverter does not run	Press the run key, the inverter will not run, and the run indicator light will be off.	Free stop function terminal is valid	Check free stop terminal
		The terminal for prohibiting the operation of the inverter is valid	Check the inverter prohibition terminal
		The external stop function terminal is valid	Check the external stop function terminal
		In the three-wire control mode, the three-wire operation control function terminal is not closed	Set and close the three-wire system operation control terminal
		Fault alarm	troubleshooting
		Improper setting of positive and negative logic of input terminal	Check F5.08 settings
P.oFF is reported immediately when the Inverter is powered on	The thyristor or contactor is disconnected and the frequency converter is heavily loaded	Because the thyristor or contactor is not closed, the DC bus voltage of the main circuit will drop when the inverter is running with a large load, and the inverter will first display P.oFF and no longer display E.Sht fault	Wait for the thyristor or contactor to be fully closed before running the drive

10.8 Fault diagnosis process

The fault diagnosis process is shown in Figure 10.2:

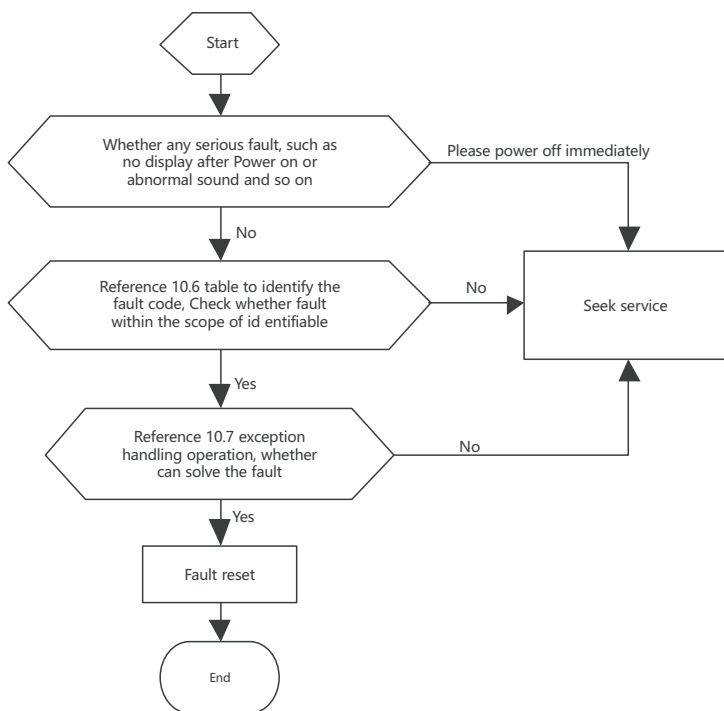

Figure 10.2 Fault Diagnosis Flowchart

11 Warranty period and environmental protection and other laws and regulations

11.1 Warranty period

Under normal storage and transportation conditions, the product packaging or the product itself is intact, 12 months from the date of purchase by the user or 18 months from the date of production, whichever comes first. The following situations are not covered by the warranty:

- 1) Damage caused by improper use, storage and maintenance by the user.
- 2) Damage caused by organizations or personnel not appointed by the company, or by disassembly and maintenance by the user.
- 3) The product has exceeded the warranty period.
- 4) Damage caused by force majeure.
- 5) When the barcode, nameplate and other marks marked by the manufacturer on the product are damaged or unrecognizable;
- 6) When the user fails to pay off the purchase price in accordance with the "Purchase and Sales Contract" signed by both parties;
- 7) When the user deliberately conceals the improper use of the product during installation, wiring, operation, maintenance or other processes from the after-sales service provider of the manufacturer.
- 8) For products that have failed, the company has the right to entrust others to maintain the warranty, and the relevant service fees are calculated according to the actual costs. If there is an agreement, the principle of priority shall be given to the agreement.
- 9) The company's sales and agencies in China can provide after-sales services for this product.

11.2 Environmental Protection

In order to protect the environment, when this product or its parts are scrapped, please treat it as industrial waste properly or hand it over to a recycling station for classification, dismantling, recycling, etc. in accordance with relevant national regulations.

Appendix A Product Peripheral Components

A.1 The connection between the product and peripheral devices

Table A.1 Description of peripheral components of the main circuit

peripheral devices	illustrate
breaker	The time characteristics of the circuit breaker should fully consider the time characteristics of the inverter overload protection, the capacity of the circuit breaker is 1.2~2 times the rated current of the inverter; In order to avoid the grid impact caused by short circuit at the output end of the inverter or internal fault, a circuit breaker must be installed at the input end of the inverter.
contactor	In order to ensure safety, please use a contactor, but do not use the contactor to control the start and stop of the inverter. Frequent closing and disconnection of the contactor will reduce the life of the inverter.
Input AC reactor or DC reactor	When the following situations occur, please connect an AC reactor to the input end of the inverter or install a DC reactor on the DC reactor terminal 1. The power supply of the inverter is greater than 600kVA or the capacity of the power supply is greater than 10 times the capacity of the inverter ; 2. If there is a switch-type reactive power compensation capacitor or a thyristor phase-controlled load on the same power node, a large peak current will flow into the input power circuit, which will cause damage to the rectifier part; 3. When the voltage imbalance of the three-phase power supply of the inverter exceeds 3%, it will cause damage to the rectifier part ; 4. The input power factor of the inverter is required to be greater than 90%.
Input Noise Filter	It can reduce the noise of the frequency converter from the input end of the power supply, and also reduce the noise from the output of the frequency converter to the power supply end.
Output AC Reactor	When the connecting line from the inverter to the motor exceeds 100 meters, it is recommended to install an AC output reactor that can suppress high-frequency oscillation to avoid motor insulation damage, excessive leakage current and frequent protection of the inverter.
Braking resistor	The mechanical energy in the braking process of the motor can be consumed in the form of heat energy through the braking resistor, which can shorten the deceleration time of the drive system of the inverter.
output noise filter	Connecting a noise filter to the output of the frequency converter can reduce conduction and radiation interference.

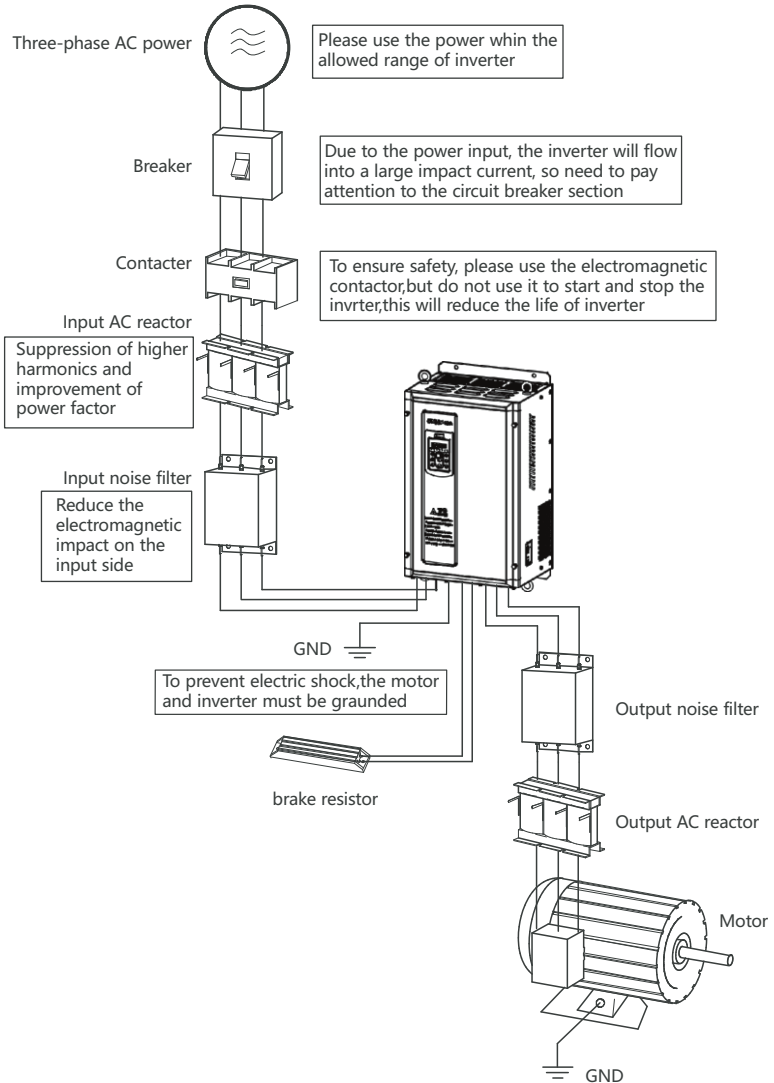



Figure A.1 Connection Diagram of Product and Peripheral Devices

A.2 Reactor selection
Table A. 2 Reactor selection

Inverter model	Input reactor	DC reactor	Output reactor
1.5 kW	ACL-0005-EISC-2	Does not support installation	OCL-0005-EISC-1
2.2 kW	ACL-0007-EISC-2	Does not support installation	OCL-0005-EISC-1
3.7 kW	ACL-0010-EISC-2	Does not support installation	OCL-0010-EISC-1
5.5 kW	ACL-0015-EISC-2	Does not support installation	OCL-0015-EISC-1
7.5 kW	ACL-0020-EISC-2	Does not support installation	OCL-0015-EISC-1
11 kW	ACL-0030-EISC-2	Does not support installation	OCL-0030-EISCL-1
15 kW	ACL-0040-EISCL-2	Does not support installation	OCL-0030-EISCL-1
18.5 kW	ACL-0040-EISCL-2	Does not support installation	OCL-0040-EISCL-1
22 kW	ACL-0050-EISCL-2	Does not support installation	OCL-0050-EISCL-1
30 kW	ACL-0060-EISCL-2	Does not support installation	OCL-0060-EISCL-1
37 kW	ACL-0090-EISCL-2	Does not support installation	OCL-0080-EISC-1
45 kW	ACL-0090-EISCL-2	DCL-0115-EIDH-4	OCL-0090-EISC-1
55 kW	ACL-0120-EISCL-2	DCL-0160-UIDH-4	OCL-0120-EISC-1
75 kW	ACL-0150-EISH-2	DCL-0180-UIDH-4	OCL-0150-EISH-1
90 kW	ACL-0200-EISH-2	DCL-0250-UIDH-4	OCL-0200-EISH-1
110 kW	ACL-0250-EISH-2	DCL-0250-UIDH-4	OCL-0200-EISH-1
132 kW	ACL-0250-EISH-2	DCL-0340-UIDH-4	OCL-0250-EISH-1
160 kW	ACL-0330-EISH-2	DCL-0460-UIDH-4	OCL-0330-EISH-1
185 kW	ACL-0390-EISH-2	DCL-0460-UIDH-4	OCL-0330-EISH-1
200 kW	ACL-0390-EISH-2	DCL-0460-UIDH-4	OCL-0390-EISH-1
220 kW	ACL-0490-EISH-2	DCL-0650-UIDH-4	OCL-0490-EISH-1
245 kW	ACL-0490-EISH-2	DCL-0650-UIDH-4	OCL-0490-EISH-1
280 kW	ACL-0600-EISH-2	DCL-0650-UIDH-4	OCL-0530-EISH-1
315 kW	ACL-0600-EISH-2	DCL-1000-UIDH-4	OCL-0600-EISH-1
355 kW	ACL-0800-EISH-2	DCL-1000-UIDH-4	OCL-0660-EISH-1
400 kW	ACL-0800-EISH-2	DCL-1000-UIDH-4	OCL-1000-EISH-1
450 kW	ACL-1000-EISH-2	DCL-1000-UIDH-4	OCL-1000-EISH-1

 Notice	Both the input reactor and the output reactor are external options , and the recommended models are shown in the table;
--	---

A.3 Classification table of braking unit and DC reactor
Table A.3 Classification table of braking unit and DC reactor

serial number	Functional Classification	power section
1	Standard built-in brake unit	NVF2G-S-1.5/PS4 ~ NVF2G-S-30/PS4
2	Optional built-in brake unit	NVF2G-S-30/TS4 ~ NVF2G-S-110/PS4
3	Optional external braking unit	NVF2G-S-110/TS4 ~ NVF2G-S-400/TS
4	Does not support the installation of DC reactors	NVF2G-S-1.5/PS4 ~ NVF2G-S-45/PS4
5	Optional external DC reactor	NVF2G-S-45/TS4 ~ NVF2G-S-110/PS4
6	Standard external DC reactor	NVF2G-S-110/TS4 ~ NVF2G-S-315/PS4
7	Standard built-in DC reactor	NVF2G-S-315/TS4 ~ NVF2G-S-400/TS4

 Notice	<ol style="list-style-type: none"> Optional built-in braking unit needs to be customized. When the brake assembly is connected externally: <ol style="list-style-type: none"> The polarities of \ominus, \odot (or \oplus, \ominus or \otimes, \odot) cannot be reversed, otherwise there is a risk of damaging the frequency converter, or even causing a fire; The wiring length of the brake unit should not exceed 10 m , and twisted-pair or tight double-wire parallel wiring should be used. When connecting external braking components or external braking resistors, please change the "overvoltage stall selection" to "prohibited" (the parameter number of FE.07 is " 0"), otherwise, within the set deceleration time will not stop.
--	--

A.4 Braking resistor table

The braking resistor selection of the inverter is shown in Table A.4 :

Table A.4 Braking resistor table

Voltage (V)	Motor power(kW)	Resistance value(Ω)	Resistance power (W)
(380~440)V	1.5	400	250
	2.2	250	250
	3.7	150	400
	5.5	100	500
	7.5	75	800
	11	50	1000
	15	40	1500
	18.5	30	4000
	22	20	4000
	30	10	6000
	37	16	9000
	45	13.6	9000
	55	10	12000
	75	6.8	18000
	90	6.8	18000
110*	6	18000	

*Including 110/PS4, excluding 110/TS4 products

A.5 leakage protector

Since there are electrostatic capacitances to the ground inside the inverter, inside the motor, and the input and output leads, and the carrier wave used by the inverter is relatively high, the leakage current of the inverter to the ground is relatively large, especially for large-capacity models, which sometimes causes the protection circuit to be damaged. Misoperation. When encountering the above problems, in addition to appropriately reducing the carrier frequency and shortening the lead wires, a leakage protector should also be installed. The leakage protector should be installed on the input side of the inverter. The operating current of the leakage protector should be greater than that of the line under industrial frequency power supply. When the frequency converter is not used, the leakage current is 10 times the sum of the leakage current of the line, noise filter, motor, etc.

Appendix B Parameter Summary

project	illustrate																																										
function code	Number of function parameter groups and parameters																																										
name	The full name of the function parameter																																										
Parameter Description	A detailed description of the function parameters																																										
unit	The unit description is as follows:																																										
	<table border="1"> <thead> <tr> <th>unit</th> <th>name</th> <th>unit</th> <th>name</th> <th>unit</th> <th>name</th> </tr> </thead> <tbody> <tr> <td>V</td> <td>Voltage</td> <td>A</td> <td>electric current</td> <td>°C</td> <td>Celsius</td> </tr> <tr> <td>mH</td> <td>millihenry</td> <td>rpm</td> <td>Rotating speed</td> <td>Ω</td> <td>ohm</td> </tr> <tr> <td>%</td> <td>percentage</td> <td>Hz</td> <td>hertz</td> <td>k Hz</td> <td>kilohertz</td> </tr> <tr> <td>kW</td> <td>kilowatt</td> <td>ms</td> <td>millisecond</td> <td>s</td> <td>Second</td> </tr> <tr> <td>min</td> <td>point</td> <td>h</td> <td>hour</td> <td>kh</td> <td>thousands of hours</td> </tr> <tr> <td>bps</td> <td>baud rate</td> <td>/</td> <td>Unitless</td> <td></td> <td></td> </tr> </tbody> </table>	unit	name	unit	name	unit	name	V	Voltage	A	electric current	°C	Celsius	mH	millihenry	rpm	Rotating speed	Ω	ohm	%	percentage	Hz	hertz	k Hz	kilohertz	kW	kilowatt	ms	millisecond	s	Second	min	point	h	hour	kh	thousands of hours	bps	baud rate	/	Unitless		
	unit	name	unit	name	unit	name																																					
	V	Voltage	A	electric current	°C	Celsius																																					
	mH	millihenry	rpm	Rotating speed	Ω	ohm																																					
	%	percentage	Hz	hertz	k Hz	kilohertz																																					
	kW	kilowatt	ms	millisecond	s	Second																																					
min	point	h	hour	kh	thousands of hours																																						
bps	baud rate	/	Unitless																																								
Defaults	The factory original setting value of the function parameter																																										
Change	Change properties of function parameters (i.e. whether changes are allowed and change conditions)																																										
	○ Indicates that the setting value of this parameter can be changed when the inverter is in stop or running state																																										
	⊗ Indicates that the setting value of this parameter cannot be changed when the inverter is running, but can be changed when the inverter is stopped																																										
	● Indicates that the value of this parameter is the actual detection record value and cannot be changed (the inverter has automatically checked and restricted the modification attributes of each parameter, which can help users avoid mistaken modification).																																										

B.1 General table of parameters

Table B.1 General table of parameters

function code	name	Parameter Description	Defaults	Change
F0 group basic function group				
F0.00	Motor control mode selection	0: SVC control 1: V/F control	1	○
F0.01	run command channel selection	0: keyboard control 1: terminal control 2: communication control	0	○
F0.02	Main frequency source selection	0: digital setting 1:A11 2: A12 3: reserved 4: reserved 5: Multi-segment instructions 6:Simple PLC 7: Closed-loop PID 8: Communication given frequency	0	○
F0.03	Auxiliary frequency source selection	Same as F0.02 (main frequency source selection)	0	○
F0.04	Main and auxiliary frequency source operation	Units: frequency source selection 0: main frequency source 1: operation result Tens place: main and auxiliary frequency source operation 0: main + auxiliary 1: Main - auxiliary 2: The maximum value of the two is MAX 3: The minimum value of the two is MIN	0x0000	○

function code	name	Parameter Description	Defaults	Change
F0.05	digital setting	F0.09 ~ F0.08	50.00Hz	○
F0.06	Running direction setting	0 : run in the default direction 1 : run in the opposite direction 2 : Reverse operation prohibited	0	○
F0.07	output frequency	F0.08 ~ 600.00Hz	50.00Hz	⊙
F0.08	frequency cap	F0.09 ~ F0.07	50.00Hz	○
F0.09	Operating frequency lower limit	0.00Hz ~ F0.08	0.00Hz	○
F0.10	Basic operating frequency	0.00Hz ~ F0.07	50.00Hz	○
F0.11	output voltage	(0 ~ 440)V	by frequency converter series decision	●
F0.12	Panel UP/DN adjustment rate	(0.01 ~ 99.99) Hz/s	1.00 Hz/s	○
F0.13	UP/DN adjustment control	Ones place: After the panel UP/DN modifies the frequency 0: The frequency is not stored when power off 1: frequency power-down storage Tens digit: After the panel UP/DN modifies the frequency 0: stop frequency keep 1: Shutdown frequency restores to initial value Hundreds place: After the terminal UP/DN modifies the frequency 0: The frequency is not stored when power off 1: frequency power-down storage Thousands digit: After the terminal UP/DN modifies the frequency 0: stop frequency keep 1: Shutdown frequency restores to initial value	0x0000	○
F0.14	Acceleration time 1	(0.0 ~ 6500.0)s	Model confirmed	○
F0.15	Deceleration time 1	(0.0 ~ 6500.0)s	Model confirmed	○
F0.16	carrier frequency	(0.5 ~ 16.0)kHz	Model confirmed	○
F0.17	Carrier frequency automatic adjustment	0 : no 1 : yes	1	○
F0.18	reserve	-	-	○
F0.19	Automatic voltage regulation (AVR) function	0: invalid 1: Valid throughout 2: Only invalid when decelerating	2	○
F0.20	parameter initialization	0: invalid operation 1: Clear fault record information (including fault information and accumulated power) 2: Restore factory parameters (except motor parameters) 3: Custom parameters restore factory defaults (except motor parameters) 4: All parameters are restored to factory values 5: Backup parameters 6: Use backup parameters 7: Save backup parameters Note: Only when the backup parameters are used, the backup parameters can be saved; otherwise, when the power is turned on after power off, except for the modified parameters, other parameters are still the original parameter values	0	○

function code	name	Parameter Description	Defaults	Change
F1 group start-stop control group				
F1.00	Starting mode	0: start from the starting frequency 1: Brake first and then start from the starting frequency 2: Speed tracking (including direction discrimination) restart	0	○
F1.01	Starting frequency	(0.00 ~ 10.00)Hz	0.00Hz	○
F1.02	Starting frequency hold time	(0.0 ~ 100.0)s	0.0s	○
F1.03	DC braking current before starting	(0.0 ~ 100.0)% (inverter rated current)	0.0%	○
F1.04	DC braking time before starting	(0.0 ~ 100.0)s	0.0s	○
F1.05	Shutdown mode	0: decelerate to stop 1: free stop 2: Deceleration to stop + DC braking	0	○
F1.06	Start frequency of DC braking at stop	0.00Hz ~ F0.07	0.00Hz	○
F1.07	Stop DC braking waiting time	(0.0 ~ 10 0.0) s	0.0s	○
F1.08	Stop DC brake current	(0.0 ~ 100.0)% (inverter rated current)	0.0%	○
F1.09	Stop DC braking time	(0.00 ~ 100.0) s	0.0s	○
F1.10	Forward and reverse dead time	(0.0 ~ 300.0)s	0.0s	⊙
F1.11	Forward and reverse switching mode	0: switch at the lower limit of running frequency F0.09 1: Switch at starting frequency F1.01	0	⊙
F1.12	reserve	-	-	●
F1.13	reserve	-	-	●
F1.14	reserve	-	-	●
F2 group first motor parameter group				
F2.00	motor type	0: Ordinary asynchronous motor	0	●
F2.01	Motor rated power	(0.1 ~ 1000.0)kW	Model confirmed	⊙
F2.02	Motor rated voltage	1V ~ Inverter rated voltage	Model confirmed	⊙
F2.03	Motor rated current	(0.01 ~ 600.0) A (inverter power<=55kW) (0.1 ~ 6 000.0) A (inverter power>55kW)	Model confirmed	⊙
F2.04	Motor rated frequency	0.01Hz ~ maximum output frequency F0.07	Model confirmed	⊙
F2.05	Number of motor poles	2 to 24	Model onfirmed	⊙
F2.06	Motor rated speed	(0 ~ 65535)rpm	1430	⊙
F2.07	Asynchronous motor stator resistance	(0.001 ~ 65.535) Ω (inverter power<=55kW) (0.0001 ~ 6.5535) Ω (inverter power>55kW)	Tuning parameters	⊙
F2.08	Asynchronous motor rotor resistance	(0.001 ~ 65.535) Ω (inverter power<=55kW) (0.0001 ~ 6.5535) Ω (inverter power>55kW)	Tuning parameters	⊙
F2.09	Asynchronous motor leakage inductance	(0.01 ~ 655.35)mH (inverter power<=55kW) (0.001 ~ 65.535)mH (inverter power>55kW)	Tuning parameters	⊙
F2.10	Mutual inductance reactance of asynchronous motor	(0.1 ~ 6553.5)mH (inverter power<=55kW) (0.01 ~ 655.35)mH (inverter power>55kW)	Tuning param	⊙

function code	name	Parameter Description	Defaults	Change
F2.11	Asynchronous motor no-load current	0.01A ~ F2.03 (inverter power <=55kW) 0.1A ~ F2.03 (inverter power>55kW)	Tuning parameters	⊙
F2.22	Motor parameter self-learning	0: no operation 1: Motor static self-learning 2: Motor dynamic self-learning		⊙
F3 group reserved parameter group				
F3.00	reserve	-	-	●
F3.01	Speed Regulator Proportional Gain 1	1~100	30	○
F3.02	Speed regulator integral gain 1	(0.01~10.00)s	0.5s	○
F3.03	Switching frequency 1	0Hz~F3.06	5.00Hz	○
F3.04	Speed Regulator Proportional Gain 2	1~100	20	○
F3.05	Speed regulator integral gain 2	(0.01~10.00)s	1.00s	○
F3.06	Switching frequency 2	F3.03~F0.07	10.00Hz	○
F3.07	SVC slip compensation coefficient	(50~200)%	100%	○
F4 group VF control group				
F4.00	V/F curve selection	0: Straight line V/F curve 1:2 power drop torque V/F curve 2: 1.7 power drop torque V/F curve 3: 1.2 power drop torque V/F curve 4: Multi-point V/F curve (set by F4.03 ~ F4.08)	0	⊙
F4.01	torque boost	0.0% (automatic) (0.1 ~ 30.0)% (relative to the rated voltage of the motor)	Model confirmed	○
F4.02	Torque boost cut-off frequency	0.00Hz ~ maximum output frequency F0.07	50.00Hz	⊙
F4.03	Multi-point VF frequency point 3	F4.05 ~ motor rated frequency F2.04	0.00Hz	⊙
F4.04	Multi-point VF voltage point 3	(0.0 ~ 100.0)%	0.0%	⊙
F4.05	Multi-point VF frequency point 2	F4.07 ~ F4.03	0.00Hz	⊙
F4.06	Multi-point VF voltage point 2	(0.0 ~ 100.0)%	0.0%	○
F4.07	Multi-point VF frequency point 1	0.00 ~ F4.05	0.00Hz	○
F4.08	Multi-point VF voltage point 1	(0.0 ~ 100.0)%	0.0%	○
F4.09	VF slip compensation gain	(0.0 ~ 200.0)%	Model confirmed	○
F4.10	VF overexcitation gain	0 ~ 200	0	○
F4.11	reserve	-	-	●
F4.12	reserve	-	-	●
F4.13	reserve	-	-	●
F4.14	reserve	-	-	●
F4.15	reserve	-	-	●
F4.16	reserve	-	-	●
F4.17	reserve	-	-	●
F4.18	reserve	-	-	●
F4.19	Oscillation suppression reactive gain	0 ~ 100	Model confirmed	○
F4.20	Oscillation suppression reactive filter coefficient	0 ~ 1000	0	○
F4.21	Oscillation suppression active gain	0 ~ 100	Model confi	○

function code	name	Parameter Description	Defaults	Change
F4.22	Oscillation suppression active power filter coefficient	0 ~ 1000	950	○
F4.23	Oscillation suppression start frequency	(0.00 ~ 600.00) Hz	2.00Hz	○
F4.24	Oscillation suppression active end load	(0.0 ~ 300.0)%	300%	○
F4.25	Oscillation suppression end frequency	(0.00 ~ 600.00) Hz	60.00Hz	○
F4.26	reserve	-	-	●
F4.27	reserve	-	-	●
F5 group input terminal parameter group				
F5.00	reserve	reserve	1	●
F5.01	X1 terminal function selection	0 ~ 63	1	◎
F5.02	X2 terminal function selection	0: no function	2	◎
F5.03	X3 terminal function selection	1: Forward running FWD 2: Run REV in reverse	9	◎
F5.04	X4 terminal function selection	3: forward jogging 4: reverse jogging	12	◎
F5.05	X5 terminal function selection	5: Three-wire operation control 6: Fault reset 7: External fault input 8: reserved 9: Running pause 10: External terminal shutdown 11: reserved 12: Free parking 13: Terminal UP 14: Terminal DOWN 15: Command switch to keyboard control 16: command switch to terminal control 17: Command to switch to communication control 18: The main frequency source is switched to digital reference 19: The main frequency source is switched to AI1 20: The main frequency source is switched to AI2 21: reserved 22: reserved 23: reserved 24: Multi-segment command terminal 1 25: Multi-segment command terminal 2 26: Multi-segment command terminal 3 27: Multi-segment command terminal 4 28: Acceleration and deceleration time selection terminal 1 29: Acceleration and deceleration time selection terminal 2 30~33: reserved 34: Forward rotation prohibited 35: Reverse prohibition 36: Acceleration and deceleration prohibited 37: UP/DN setting reset 38: reserved 39: reserved 40: reserved 41: reserved 42: reserved 43: PID integral pause 44: PID prohibited 45: The direction of PID action is reversed 46: reserved 47: reserved 48: DC braking 49: Frequency setting effective terminal 50: reserved 51: The current running time is cleared 52~63: reserved	0	◎
F5.06	X6 terminal function selection			

function code	name	Parameter Description	Defaults	Change
F5.07	Valid state setting of input terminal (X1 ~ X6)	Setting range: 0x0000 ~ 0x001F Binary settings: 0: normal logic, conduction is valid 1: Logical inversion, valid when disconnected Units: BIT0 ~ BIT3: X1 ~ X4 ten digits: BIT0: X5 BIT1: X6 BIT2 ~ BIT3: Reserved	0x0000	○
F5.08	Input terminal filter time	(0.000 ~ 1.000)s	0.010s	○
F5.09	Terminal control mode selection	0: Two-wire control mode 1 1: Two-wire control mode 2 2: Three-wire control mode 1 3: Three-wire control mode 2	0	○
F5.10	Terminal UP/DN rate	(0.001 ~ 65.535)Hz/s	1.000Hz/s	○
F5.11	X1 terminal delay time	(0.000 ~ 60.000)s	0.000s	○
F5.12	X2 terminal delay time	(0.000 ~ 60.000)s	0.000s	○
F5.13	X3 terminal delay time	(0.000 ~ 60.000)s	0.000s	○
F5.14	X4 terminal delay time	(0.000 ~ 60.000)s	0.000s	○
F5.15	X5 terminal delay time	(0.000 ~ 60.000)s	0.000s	○
F5.16	X6 terminal delay time	(0.000 ~ 60.000)s	0.000s	○
F5.17	reserve	-	-	●
F5.18	reserve	-	-	●
F5.19	reserve	-	-	●
F5.20	reserve	-	-	●
F5.21	reserve	-	-	●
F5.22	reserve	-	-	●
F5.23	AI1 filter	(0.00 ~ 10.00)s	0.05s	○
F5.24	AI2 filter	(0.00 ~ 10.00)s	0.05s	○
F5.25	reserve	-	-	●
F5.26	reserve	-	-	●
F5.27	Minimum setting of AI1 curve	0.00V ~ F5.29	0.00V	○
F5.28	Corresponding setting of AI1 curve minimum reference	(-100.0 ~ +100.0)%	0.0%	○
F5.29	AI1 curve maximum setting	F5.27 ~ +11.00V	10.00V	○
F5.30	AI1 curve maximum given	(-100.0 ~ +100.0)%	100.0%	○
F5.31	Minimum setting of AI2 curve	0.00 ~ F5.33	0.00V	○
F5.32	AI2 curve minimum given corresponding setting	(-100.0 ~ +100.0)%	0.0%	○
F5.33	AI2 curve maximum setting	F5.31 ~ +11.00V	10.00V	○
F5.34	AI2 curve maximum given	(-100.0 ~ +100.0)%	100.0%	○
F5.35	reserve	-	-	●
F5.36	reserve	-	-	●
F5.37	reserve	-	-	●
F5.38	reserve	-	-	●
F5.39	reserve	-	-	●
F5.40	reserve	-	-	
F5.41	reserve	-	-	
F5.42	reserve	-	-	
F5.43	reserve	-	-	
F5.44	reserve	-	-	

function code	name	Parameter Description	Defaults	Change
F5.45	reserve	-	-	
F5.46	reserve	-	-	
F5.47	reserve	-	-	
F5.48	AI1 measured voltage 1	(0.000 ~ + 30.000)V	2.000V	○
F5.49	AI1 display voltage 1	(0.000 ~ + 30.000)V	2.000V	○
F5.50	AI1 measured voltage 2	(0.000 ~ + 30.000)V	8.000V	○
F5.51	AI1 display voltage 2	(0.000 ~ + 30.000)V	8.000V	○
F5.52	AI2 measured voltage 1	(0.000 ~ + 30.000)V	2.000V	○
F5.53	AI2 display voltage 1	(0.000 ~ + 30.000)V	2.000V	○
F5.54	AI2 measured voltage 2	(0.000 ~ + 30.000)V	8.000V	○
F5.55	AI2 display voltage 2	(0.000 ~ + 30.000)V	8.000V	○
F5.56	reserve	-	-	
F5.57	reserve	-	-	
F5.58	reserve	-	-	
F5.59	reserve	-	-	
F6 group output terminal parameter group				
F6.00	reserve	-	-	●
F6.01	Y1 output selection	0 ~ 63	1	○
F6.02	Relay RO 1 output selection	0: no output	16	○
F6.03	Relay RO2 output selection	1: The inverter is running 2: Frequency level detection FDT1 arrival 3: Frequency level detection FDT2 arrival 4: Inverter overload pre-alarm 5: Undervoltage status output 6: External fault shutdown 7: The upper limit frequency is reached 8: The lower limit frequency is reached 9: Running at zero speed 10~14: reserved 15: The drive is ready to run 16: Fault output 17~18: reserved 19: Torque limited 20: Speed direction 21: reserved 22: Frequency arrival 23: reserved 24: Unloading 25: Zero current state 26: Current reaches 1 27 : The current reaches 2 28: Module temperature reaches 29: The output current exceeds the limit 30: reserved 31: Motor overload pre-alarm 32: reserved 33: reserved 34: Arrive on time 35: AI1 > AI2 36: reserved 37: The current running time is reached 38~63: reserved	1	○
F6.04	Valid state setting of output terminal (Y1 , RO1 , RO2)	Setting range: 0x0000~0x0007 Binary setting: 0 : Enabled and valid 1 : Disconnect is valid Units: BIT0 ~ BIT2 : Y1 , RO1 , RO2 Tens: Reserved	0x0000	○

function code	name	Parameter Description	Defaults	Change
F6.05	Y1 output delay time	(0.0 ~ 3600.0)s	0.0s	○
F6.06	Relay RO 1 output delay time	(0.0 ~ 3600.0)s	0.0s	○
F6.07	Relay RO2 output delay time	(0.0 ~ 3600.0)s	0.0s	○
F6.08	AO1 output function selection	0 ~ 36 0: no function 1: Operating frequency (0~maximum frequency) 2: Set frequency (0~maximum frequency) 3: Set frequency(after acceleration and deceleration) (0~ maximum frequency) 4: Output speed (0~maximum frequency) 5: Output current (0 to 2 times the rated current of the inverter) 6: Output current 2 (0 to 2 times the rated current of the motor)	0	○
F6.09	AO2 output function selection	7: Output torque (absolute value) (0~3 times the rated torque of the motor) 8: Output power (0~2 times the rated power of the motor) 9: Output voltage (0~1.2 times the rated voltage of the inverter) 10: Bus voltage (0~1000V) 11: AI1 12: AI2 13 ~ 36: reserved	0	○
F6.10	reserve	-	-	●
F6.11	reserve	-	-	●
F6.12	AO1 zero offset correction coefficient	(-100.0 ~ 100.0)%	0.0%	●
F6.13	AO1 gain	-10.00 ~ +10.00	1.00	○
F6.14	AO2 zero offset correction coefficient	(-100.0 ~ 100.0)%	0.0%	○
F6.15	AO2 Gain	-10.00 ~ +10.00	1.00	○
F6.16	reserve	-	-	●
F6.17	reserve	-	-	●
F6.18	reserve	-	-	●
F6.19	Frequency arrival (FAR) detection width	(0.0 ~ 100.0)%	5.0%	○
F6.20	FDT1 level	0.00Hz ~ F0.07	50.00Hz	○
F6.21	FDT1 hysteresis	(0.0 ~ 100.0)%	5.0%	○
F6.22	FDT2 level	0.00Hz ~ F0.07	25.00Hz	○
F6.23	FDT2 hysteresis	(0.0 ~ 100.0)%	5.0%	○
F6.24	AO1 measured voltage 1	(0.000 ~ + 3 0.000)V	2.000V	○
F6.25	AO1 display voltage 1	(0.000 ~ + 3 0.000)V	2.000V	○
F6.26	AO1 measured voltage 2	(0.000 ~ + 3 0.000)V	8.000V	○
F6.27	AO1 display voltage 2	(0.000 ~ + 3 0.000)V	8.000V	○
F6.28	AO2 measured voltage 1	(0.000 ~ + 3 0.000)V	2.000V	○
F6.29	AO2 display voltage 1	(0.000 ~ + 3 0.000)V	2.000V	○
F6.30	AO2 measured voltage 2	(0.000 ~ + 3 0.000)V	8.000V	○
F6.31	AO2 display voltage 2	(0.000 ~ + 3 0.000)V	8.000V	○
F6.32	reserve	-	-	●
F6.33	reserve	-	-	●
F6.34	reserve	-	-	●
F6.35	reserve	-	-	●

function code	name	Parameter Description	Defaults	Change
F7 group panel function group				
F7.00	user password	0000: no password Other: password protection	0000	○
F7.01	Keypad lock function	0: no lock 1: Full lock 2: reserved 3: All locked except PRG/S key (SHIFT function) 4: All lock except RUN and STOP keys	0	○
F7.02	MF (multi-function) button function selection	0: Jogging operation 1: free stop 2: Quick shutdown 3: Forward and reverse switching 4: UP/DN setting clear	0	○
F7.03	Parameter protection settings	0: All data is allowed to be rewritten 1: Except digital setting (F0.05) and this function code, rewriting is prohibited 2: Except for this function code, all rewriting is prohibited	0	○
F7.04	reserve	-	-	●
F7.05	Parameter selection for operating status display 1	Setting range: 0x0007 ~ 0xFFFF(3FFF) Bit00: output frequency (Hz bright) Bit01: set frequency (Hz flickering) Bit02: bus voltage (V on) Bit03: output voltage (V bright) Bit04: output current (A is on) Bit05: Running speed (rpm on) Bit06: output power (% on) Bit07: Output torque (% on) Bit08: PID setting (% flashing) Bit09: PID feedback (% bright) Bit10: input terminal state Bit11: output terminal state Bit12: Torque setting value (% on) Bit13: PLC current segment number Bit14: set speed Bit15: reserved	0x0017	○
F7.06	Parameter selection for operating status display 2	Setting range: 0x0000 ~ 0x000F Bit00: Analog AI1 value (V is on) Bit01: Analog AI2 value (V is on) Bit02 ~ Bit15: Reserved	0x0000	○
F7.07	Parameter selection for stop state display	Same as F7.05	0x0003	○
F7.08	STOP key stop function selection	0: Only valid for panel control 1: Valid for panel and terminal control 2: Valid for panel and communication control 3: Valid for all control modes	3	○
F7.09	reserve	-	-	●
F7.10	reserve	-	-	●
F7.11	reserve	-	-	●
F7.12	reserve	-	-	●
F7.13	reserve	-	-	●
F7.14	reserve	-	-	●

function code	name	Parameter Description	Defaults	Change
F8 group enhanced function group				
F8.00	Jog running frequency	0.10 Hz ~ maximum output frequency F0.07	5.00Hz	○
F8.01	jogging acceleration time	(0.0 ~ 6500.0)s	20.0s	○
F8.02	Jogging deceleration time	(0.0 ~ 6500.0)s	20.0s	○
F8.03	reserve	-	-	●
F8.04	Acceleration time 2	(0.0 ~ 6500.0)s	Model confirmed	○
F8.05	Deceleration time 2	(0.0 ~ 6500.0)s	Model confirmed	○
F8.06	Acceleration time 3	(0.0 ~ 6500.0)s	Model confirmed	○
F8.07	Deceleration time 3	(0.0 ~ 6500.0)s	Model confirmed	○
F8.08	Acceleration time 4	(0.0 ~ 6500.0)s	Model confirmed	○
F8.09	Deceleration time 4	(0.0 ~ 6500.0)s	Model confirmed	○
F8.10	jump frequency 1	0.00 Hz ~ maximum output frequency F0.07	0.00Hz	○
F8.11	Hop frequency 1 range	0.00 Hz ~ maximum output frequency F0.07	0.00Hz	○
F8.12	jump frequency 2	0.00Hz ~ maximum output frequency F0.07	0.00Hz	○
F8.13	Hop frequency 2 range	0.00Hz ~ maximum output frequency F0.07	0.00Hz	○
F8.14	jump frequency 3	0.00Hz ~ maximum output frequency F0.07	0.00Hz	○
F8.15	Hop frequency 3 range	0.00Hz ~ maximum output frequency F0.07	0.00Hz	○
F8.16	Action voltage of braking unit	(650 ~ 800)V (380V series) (320 ~ 380)V (230V series)	720V (380V series) 360V (230V series)	○
F8.17	Dynamic braking option	0: no action 1: action	0	○
F8.18	Energy consumption braking utilization rate	(0.0 ~ 100.0)%	80.0%	○
F8.19	Zero frequency operation threshold	(0.00 ~ 300.00)Hz	0.50Hz	○
F8.20	Zero current detection value	(0.0 ~ 300.0) %	5.0%	○
F8.21	Zero current detection delay time	(0.00 ~ 600.00)s	0.10s	○
F8.22	Output current exceeds limit	(0.0~300.0)%	200.0%	○
F8.23	Output current overrun detection delay time	(0.00~600.00)s	0.00s	○
F8.24	Current reaches detection value 1	(0.0~300.0)%	100.0%	○
F8.25	Current arrival detection 1 amplitude	(0.0~300.0)%	0.0%	○
F8.26	Current reaches detection value 2	(0.0~300.0)%	100.0%	○
F8.27	Current arrival detection 2 amplitude	(0.0~300.0)%	0.0%	○
F8.28	Module temperature reaches	(0~100) °C	75 °C	○
F8.29	Automatic fan control	0: run in automatic mode 1: The fan keeps running when the power is on	0	○
F8.30	reserve	-	-	●
F8.31	Boot Protection Selection	0: start protection is invalid 1: start protection is valid	1	○

function code	name	Parameter Description	Defaults	Change
F8.32	Timing function selection	0: invalid 1: effective	0	○
F8.33	Timing run time	(0.0 ~ 6500.0)min	0.0min	○
F8.34	Set the cumulative running time (used with relay RO)	(0.0 ~ 6500.0)min	0.0min	○
F8.35	Power failure restart function selection	0: invalid 1: effective	0	○
F8.36	Waiting time for restart after power failure	(0.0 ~ 10.0)s	0.0s	○
F8.37	The set frequency is lower than the lower limit frequency operation mode	0: run at the lower limit frequency 1: Deceleration to stop	0	○
F8.38	jogging preference	0: invalid 1: effective	1	○
F9 group process PID control group				
F9.00	given channel selection	0: digital given 1:A1 2: A12 3: reserved 4: reserved 5: reserved 6: Multi-segment instruction given	1	○
F9.01	Feedback Channel Selection	0:A11 1:A12 2: reserved 3:A11+A12 4:A11-A12 5:MIN(A11,A12) 6:MAX(A11,A12) 7: reserved 8: reserved	1	○
F9.02	Given quantity digital setting	(0.0 ~ 100.0)%	50.0%	○
F9.03	Proportional gain KP	0.0 ~ 100.0	20.0	○
F9.04	Integral gain Ki	0.01 ~ 10.00	2.00	○
F9.05	Differential gain Kd	0.000 ~ 10.000	0.000	○
F9.06	The sampling period	(0.01 ~ 50.00)s	0.50s	○
F9.07	given change time	(0.00 ~ 650.00)s	0.00s	○
F9.08	Feedback filter time	(0.00 ~ 60.00)s	0.00s	○
F9.09	output filter time	(0.00 ~ 60.00)s	0.00s	○
F9.10	deviation limit	(0.0 ~ 100.0)%	0.0%	○
F9.11	differential clipping	(0.00 ~ 100.00)%	0.10%	○
F9.12	Maximum positive deviation between two outputs	(0.00 ~ 100.00)%	1.00%	○
F9.13	Maximum reverse deviation between two outputs	(0.00 ~ 100.00)%	1.00%	○
F9.14	Closed-loop output reversal selection	0: The closed-loop output is negative, and the inverter runs at the lower limit frequency 1: The closed-loop output is negative, and the inverter runs in reverse	0	○
F9.15	Closed-loop regulation characteristics	0: positive direction 1: Reverse direction	0	⊗

function code	name	Parameter Description	Defaults	Change
F9.16	Integral Adjustment Options	0: When the frequency reaches the upper and lower limits, stop integration 1: When the frequency reaches the upper and lower limits, continue to integrate	0	○
F9.17	reserve	-	-	●
F9.18	reserve	-	-	●
F9.19	reserve	-	-	●
F9.20	reserve	-	-	●
F9.21	reserve	-	-	●
F9.22	reserve	-	-	●
F9.23	Closed-loop preset initial value	(0.0 ~ 100.0)%	0.0%	○
F9.24	Preset initial value hold time	(0.00 ~ 650.00)s	0.00s	⊙
F9.25	Given feedback range	0 ~ 65535	1000	○
F9.26	Feedback loss detection value	(0.0 ~ 100.0)%	0.0%	○
F9.27	Feedback loss detection time	(0.0 ~ 20.0)s	0.0	○
F9.28	Closed loop operation mode	0: No operation when stopped 1: Calculation at shutdown	0	○
F9.29	Closed Loop Alternate Channel Selection	0: digital given 1: AI1 2: AI2 3: reserved 4: reserved	0	○
F9.30	sleep function enabled	0: invalid 1: effective	0	○
F9.31	sleep frequency	0.00Hz ~ F0.07	0.00Hz	○
F9.32	sleep delay	0.0s ~ 6500.0s	0.0s	○
F9.33	arousal bias	(0.0 ~ 100.0)%	0.0%	○
F9.34	wake up delay	(0.0 ~ 6500.0)s	0.0s	○

FA group simple PLC and multi-stage speed control group

FA.00	Simple PLC operation mode selection	Setting range: 0x0000 ~ 0x0112 Units: PLC operation mode 0: Stop after a single cycle 1: Keep the final value after a single loop 2: continuous loop Tens place: Shutdown storage 0: do not store 1: Store downtime phase, frequency Hundreds digit: power-off storage 0: do not store 1: Store power-off time stage, frequency Thousands place: stage time unit selection 0: seconds 1 point	0x0000	○
FA.01	Phase 1 Setup	Setting range: 0x0000 ~ 0x0315 Units: frequency source 0: multi-band frequency N 1~5: reserved Tens place: running direction 0: forward rotation 1: reverse Hundreds place: Acceleration and deceleration time 0: Acceleration and deceleration time 1 1: Acceleration and deceleration time 2 2: Acceleration and deceleration time 3 3: Acceleration and deceleration time 4	0x0000	○

function code	name	Parameter Description	Defaults	Change
FA.02	Phase 1 run time	0.0 ~ 6500.0	20.0	○
FA.03	Phase 2 Setup	Same as FA.01	0x0000	○
FA.04	Phase 2 runtime	0.0 ~ 6500.0	20.0	○
FA.05	Phase 3 Setup	Same as FA.01	0x0000	○
FA.06	Phase 3 run time	0.0 ~ 6500.0	20.0	○
FA.07	Phase 4 Setup	Same as FA.01	0x0000	○
FA.08	Phase 4 runtime	0.0 ~ 6500.0	20.0	○
FA.09	Stage 5 Setup	Same as FA.01	0x0000	○
FA.10	Phase 5 run time	0.0 ~ 6500.0	20.0	○
FA.11	Stage 6 Setup	Same as FA.01	0x0000	○
FA.12	Phase 6 run time	0.0 ~ 6500.0	20.0	○
FA.13	Stage 7 Setup	Same as FA.01	0x0000	○
FA.14	Phase 7 run time	0.0 ~ 6500.0	20.0	○
FA.15	Stage 8 Setup	Same as FA.01	0x0000	○
FA.16	Phase 8 run time	0.0 ~ 6500.0	20.0	○
FA.17	Stage 9 Setup	Same as FA.01	0x0000	○
FA.18	Phase 9 run time	0.0 ~ 6500.0	20.0	○
FA.19	Stage 10 Setup	Same as FA.01	0x0000	○
FA.20	Phase 10 run time	0.0 ~ 6500.0	20.0	○
FA.21	Stage 11 Setup	Same as FA.01	0x0000	○
FA.22	Phase 11 run time	0.0 ~ 6500.0	20.0	○
FA.23	Stage 12 Setup	Same as FA.01	0x0000	○
FA.24	Phase 12 run time	0.0 ~ 6500.0	20.0	○
FA.25	Stage 13 Setup	Same as FA.01	0x0000	○
FA.26	Phase 13 run time	0.0 ~ 6500.0	20.0	○
FA.27	Stage 14 Setup	Same as FA.01	0x0000	○
FA.28	Phase 14 run time	0.0 ~ 6500.0	20.0	○
FA.29	Stage 15 Setup	Same as FA.01	0x0000	○
FA.30	Phase 15 run time	0.0 ~ 6500.0	20.0	○
FA.31	Multi-segment instruction 1	(-100.0 ~ 100.0)%	0.0%	○
FA.32	multi-segment instruction 2	(-100.0 ~ 100.0)%	0.0%	○
FA.33	Multi-stage instruction 3	(-100.0 ~ 100.0)%	0.0%	○
FA.34	Multi-segment instruction 4	(-100.0 ~ 100.0)%	0.0%	○
FA.35	Multi-segment instruction 5	(-100.0 ~ 100.0)%	0.0%	○
FA.36	Multi-segment instruction 6	(-100.0 ~ 100.0)%	0.0%	○
FA.37	Multi-segment instruction 7	(-100.0 ~ 100.0)%	0.0%	○
FA.38	Multi-segment instructions 8	(-100.0 ~ 100.0)%	0.0%	○
FA.39	Multi-segment instructions 9	(-100.0 ~ 100.0)%	0.0%	○
FA.40	Multi-segment instructions 10	(-100.0 ~ 100.0)%	0.0%	○
FA.41	Multi-segment instructions 11	(-100.0 ~ 100.0)%	0.0%	○
FA.42	Multi-segment instruction 12	(-100.0 ~ 100.0)%	0.0%	○
FA.43	Multi-stage instruction 13	(-100.0 ~ 100.0)%	0.0%	○
FA.44	Multi-segment instructions 14	(-100.0 ~ 100.0)%	0.0%	○
FA.45	Multi-segment instruction 15	(-100.0 ~ 100.0)%	0.0%	○
FA.46	reserve	-	-	●

function code	name	Parameter Description	Defaults	Change
Fb group serial communication parameter group				
Fb.00	Local mailing address	1 ~ 247	1	○
Fb.01	Communication baud rate setting	0:2400BPS 1:4800BPS 2:9600BPS 3:19200BPS 4:38400BPS	2	○
Fb.02	Data bit check setting	0: no parity (8-N-2) for RTU 1: Odd parity (8-O-1) for RTU 2: Even parity (8-E-1) for RTU 3: No parity (7-N-2) for RTU 4: Odd parity (7-O-1) for RTU 5: Even parity (7-E-1) for RTU 6: No parity (8-N-2) for ASCII 7: Odd parity (8-O-1) for ASCII 8: Even parity (8-E-1) for ASCII 9: No parity (7-N-2) for ASCII 10: Odd parity (7-O-1) for ASCII 11: Even parity (7-E-1) for ASCII 12: No parity (8-N-1) for RTU	12	○
Fb.03	Communication response delay	(0 ~ 200) m s	5ms	○
Fb.04	Communication timeout fault time	(0. 0 ~ 100.0) s	0.0s	○
Fb.05	Transport Error Handling	0: alarm and stop freely 1: No alarm and continue to run 2: No alarm, stop according to the shutdown mode (only in the communication control mode) 3: No alarm, stop according to the shutdown mode (under all control modes)	1	○
Fb.06	Communication processing action selection	0: There is a response to the write operation (the inverter responds to the write commands of the host computer) 1: No response to write operation (the inverter only responds to the read command of the host computer, but does not respond to the write command. This method can improve communication efficiency)	1	○
FC group reserved parameter group				
FC.00	reserve	-	-	●
Fd group state display parameter group				
Fd.00	Main given set frequency	(0.00 ~ +600.00)Hz	0.00Hz	●
Fd.01	Auxiliary given set frequency	(0.00 ~ +600.00)Hz	0.00Hz	●
Fd.02	set frequency	(0.00 ~ +600.00)Hz	0.00Hz	●
Fd.03	Frequency command (after acceleration and deceleration)	(0.00 ~ +600.00)Hz	0.00Hz	●
Fd.04	Torque given	(-300.0 ~ +300.0)% (relative to the rated torque of the motor)	0.0%	●
Fd.05	Output frequency	(0.00 ~ +600.00)Hz	0.00Hz	●
Fd.06	The output voltage	(0 ~ 480) V	1	●
Fd.07	Output current	(0.0 ~ 3000.0) A (relative to 0.0 ~ 3.0) le)	0.0A	●
Fd.08	Operating speed	(0 ~ 60000)rpm	0rpm	●
Fd.09	Output torque	(-300.0 ~ +300.0)% (compared to twice the rated torque of the motor)	0.0%	●

function code	name	Parameter Description	Defaults	Change
Fd.10	ASR controller output	(-300.0 ~ +300.0)% (compared to twice the rated torque of the motor)	0.0%	●
Fd.11	Torque current	(-300.0 ~ +300.0)%	0.0%	●
Fd.12	flux current	(0 ~ 100.0)%	0.0%	●
Fd.13	Motor Power	(0.0 ~ 2000.0)kW	0.1kW	●
Fd.14	Motor estimated frequency	(-300.00 ~ +300.00)Hz	0.00Hz	●
Fd.15	Motor measured frequency	(-300.00 ~ +300.00)Hz	0.00Hz	●
Fd.16	bus voltage	(0 ~ 800)V	0	●
Fd.17	Inverter running status	Setting range: 0x0000~0xFFFF Bit0: run/stop Bit1: reverse/forward Bit2: Zero speed running Bit3: Accelerating Bit4: Decelerating Bit5: Constant speed running Bit6: Pre-excitation Bit7: Self-learning Bit8: Overflow stall Bit9: DC overvoltage stall Bit10: speed limit Bit11: frequency limit Bit12: Inverter fault Bit13: Operation preparation completed Bit14: reserved Bit15: undervoltage/normal	0x0000	●
Fd.18	Digital input terminal state	Setting range: 0x0000~0xFFFF 0: disconnected 1: closed Units: BIT0 ~ BIT3: X1 ~ X4 ten digits: BIT0: X5 BIT1: X6 BIT2~BIT3: reserved	0x0000	●
Fd.19	Switch output terminal state	Setting range: 0x0000~0xFFFF 0: disconnected; 1: closed Units: BIT3 : Y1, RO1 , RO2 Tens: Reserved	0x0000	●
Fd.20	A11 input voltage	(-10.00 ~ +11.00)V	0.00V	●
Fd.21	A12 input voltage	(-10.00 ~ +11.00)V	0.00V	●
Fd.22	reserve	-	-	●
Fd.23	A11 adjusted percentage	(-100.00 ~ 110.00)%	0.00%	●
Fd.24	A12 adjusted percentage	(-100.00 ~ 110.00)%	0.00%	●
Fd.25	reserve	-	-	●
Fd.26	AO1 output	(0.0 ~ 100.0)%(relative to the percentage of full scale)	0.0%	●
Fd.27	AO2 output	(0.0 ~ 100.0)%(relative to the percentage of full scale)	0.0%	●
Fd.28	Process closed-loop given	(0.0 ~ 100.0)%(relative to the percentage of full scale)	0.0%	●
Fd.29	Process Closed Loop Feedback	(0.0 ~ 100.0)%(relative to the percentage of full scale)	0.0%	●
Fd.30	process closed loop error	(0.0 ~ 100.0)%(relative to the percentage of full scale)	0.0%	●
Fd.31	Process closed loop output	(0.0 ~ 100.0)%(relative to the percentage of full scale)	0.0%	●
Fd.32	reserve	-	-	●
Fd.33	PLC current segment number	0 ~ 15	0	●
Fd.34	radiator temperature	(0.0 ~ 200.0) °C	0.0	●

function code	name	Parameter Description	Defaults	Change
Fd.35	Rectifier bridge temperature	(1~200) °C	0 °C	●
Fd.36	Cumulative power-on time	0 ~ maximum timing 65535 hours	0	●
Fd.37	Cumulative running time	0 ~ maximum timing 65535 hours	0	●
Fd.38	Accumulated fan running time	0 ~ maximum timing 65535 hours	0	●
Fd.39	Rated Capacity	(0 ~ 999.9)kVA (automatically set by the model)	factory setting	●
Fd.40	Rated voltage	(0 ~ 999.9)kVA (automatically set by the model)	factory setting	●
Fd.41	Rated current	(0 ~ 999.9)kVA (automatically set by the model)	factory setting	●
Fd.42	Product serial number	Setting range: 0x0000~0xFFFF	0x0205	●
Fd.43	software version number	0.00 to 99.99	factory setting	●
Fd.44	Customized version number	0 ~ 99.99	factory setting	●
Fd.45	Year the source code was compiled	2014-2099	factory setting	●
Fd.46	Source code compilation date	101 ~ 1231	factory setting	●
Fd.47	set speed	(0 ~ 60000)rpm	0	●
Fd.48	current running time	(1 ~ 65535)min	0	●
Fd.49	remaining run time	(0 ~ 65535)H	0	●
Fd.50	power factor angle	0.1 ~ 20.0	0	●
Fd.51	reserve	-	-	●
Fd.52	reserve	-	-	●
Fd.53	Inverter GP type	0 ~ 3	0	●
Fd.54	motor temperature	(1~200) °C	0 °C	●
Fd.55	Cumulative electricity	0~65535 degrees	0 degree	●
FE protection and early warning function group				
FE.00	Motor overload protection selection	0: disabled 1: allow	1	⊙
FE.01	Motor overload protection gain	0.20 ~ 10.00	1.00	⊙
FE.02	Motor overload warning enable	0: invalid 1: effective	0	⊙
FE.03	Motor overload warning level	(20 ~ 200)%	80%	○
FE.04	reserve	-	-	●
FE.05	Overvoltage stall gain	0 to 100 (0 : disabled)	1	○
FE.06	Overvoltage stall protection voltage	(120 ~ 150)%	120%	○
FE.07	Overrun stall enable	0: disabled 1: valid	1	○
FE.08	Overcurrent stall protection current	(100-200)%	150%	○
FE.09	Power-on short-circuit protection selection	0: invalid 1: effective	1	○
FE.13	Instantaneous power failure action selection	0: invalid 1: slow down 2: Deceleration to stop	0	○
FE.14	Instantaneous operation pause judgment voltage	(80.0 ~ 100.0)%	90.0%	○

function code	name	Parameter Description	Defaults	Change
FE.15	Instantaneous power failure voltage recovery judgment time	(0.00 ~ 100.00)s	0.50s	○
FE.16	Instantaneous power failure action judgment voltage	(60.0 ~ 100.0)% (standard bus voltage)	80.0%	○
FE.17	Load Loss Protection Selection	0: invalid 1: effective	0	○
FE.18	Load drop detection level	(0.0 ~ 100.0)%	10.0%	○
FE.19	Load drop detection time	(0.0 ~ 60.0)s	1.0s	○
FE.20	over speed detection value	(0.0 ~ 50.0)% (maximum output frequency)	20.0%	○
FE.21	over speed detection time	(0.0 ~ 60.0)s (0.0s not detected)	1.0s	○
FE.22	Excessive speed deviation detection value	(0.0 ~ 50.0)% (maximum output frequency)	20.0%	○
FE.23	Excessive speed deviation detection time	(0.0 ~ 60.0)s (0.0s not detected)	5.0s	○
FE.24	Input phase loss detection selection	0: Input phase loss hardware detection 1: Input phase loss software detection 2: Input phase loss software and hardware are not detected	1	⊙
FE.25	Output phase loss detection selection	0: Output phase loss software does not detect 1: Output phase loss software detection	1	○
FE.26	Fault automatic reset times	0 ~ 20	0	○
FE.27	Fault automatic reset interval time	(0.1 ~ 100.0)s	1.0s	○
FE.28	O action selection during fault automatic reset	0: Fault lock disabled 1: Fault lock is allowed	0	○
FE.29	Fault record 1	0 ~ 55 0: no fault No 1: Acceleration overcurrent E.OC1 2: deceleration overcurrent E.OC2 3: Constant speed overcurrent E.OC3 4: Acceleration overvoltage E.OU1 5: Deceleration overvoltage E.OU2 6: Constant speed overvoltage E.OU3 7: reserved 8: Input phase loss E.SPI 9: Output phase loss E.SPO 10: Inverter unit protection E.FO 11: Radiator overheating E.OH1 12: Overheating of the rectifier bridge E.OH2 13: Inverter overload E.OL2 14: Motor overload E.OL1 15: External fault E.EF 16: EEPROM exception E.EEP 17: Abnormal communication E.CE 18: Abnormal contactor E.SHt 19: Abnormal current detection E.ItE 20: reserved 21: reserved 22: reserved 23: reserved Abnormal motor self-learning E.tE 25: reserved 26: reserved 27: reserved 28: reserved 29: reserved 30: reserved 31: Undervoltage E.Uv	0	●

function code	name	Parameter Description	Defaults	Change
FE.29	Fault record 1	32: Buffer power overload E.OL3 33: Motor short circuit to ground E.StG 34: Wave-by-wave current limiting fault E.CbC 35: Inverter hardware overcurrent fault E.Inv 36: Load E.LL 37: PID feedback lost during operation E.FbL 38: Motor overtemperature E.OT 39: reserved 40: reserved 41: reserved 42: The speed deviation is too large E.dEv 43: Motor overspeed E.OS 44 ~ 55: Reserved	0	●
FE.30	Third (most recent) failure	busbar voltage (0.00 ~ 655.35)V	0.00V	●
FE.31	Third (most recent) failure time current	(0.00 ~ 655.35)A	0.00A	●
FE.32	Third (most recent) failure time frequency	(0.00 ~ 655.35)A	0.00Hz	●
FE.33	Third (most recent) failure time inverter status	0 ~ 65535	0	●
FE.34	Third (most recent) failure Time input terminal status	0 ~ 9999	0	●
FE.35	Third (most recent) failure Time output terminal status	0 ~ 9999	0	●
FE.36	Fault record 2	0 ~ 55	0	●
FE.37	Fault record 3	0 ~ 55	0	●
FE.38	Protection action selection 1 at fault	0x0000 ~ 0x2222 Units: motor overload E.OL1 0: Free parking 1: Shut down according to the shutdown mode 2: continue to run Tens place: input phase loss E.SPI (same as ones place) Hundreds place: output phase loss E.SPO (same as ones place) Thousands place: external fault E.EF (same as ones place)	0x0000	○
FE.39	Protection action selection 2 at fault	0x0000 ~ 0x2222 Units: communication abnormality E.CE 0: Free parking 1: Shut down according to the shutdown mode 2: continue to run ten digits: reserved Hundreds place: EEPROM exception E.EEP 0: Free parking 1: Shut down according to the shutdown mode Thousands: Reserved	0x0000	○

function code	name	Parameter Description	Defaults	Change
FE.40	Protection action option 3 at fault	0x0000 ~ 0x2222 Ones place: drop load E.LL 0: Free parking 1: decelerate to stop 2: Jump directly to 7% of the rated frequency of the motor to continue running, and automatically return to the set frequency when the load is not lost Tens place: PID feedback lost during operation E.FbL 0: Free parking 1: Shut down according to the shutdown mode 2: continue to run Hundreds place: excessive speed deviation E.dEv (same as tens place) Thousands digit: motor overspeed E.OS (same as tens digit)	0x0000	○
FE.41	Protection action selection 4 in case of failure	0x0000 ~ 0x2222 Units: Reserved Tens: Reserved Hundreds place: Reserved Thousands: Reserved	0x0000	○
FE.42	Protection action option 5 in case of failure	0x0000 ~ 0x2222 Units: Reserved Tens: Reserved Hundreds place: Reserved Thousands: Reserved	0x0000	○
FE.43	Continue to run frequency selection in case of failure	0 ~ 4 0: Run at the current running frequency 1: Run at the set frequency 2: Run at the upper limit frequency 3: Run at the lower limit frequency 4: Run at the standby frequency when abnormal	0	○
FE.44	Abnormal standby frequency setting	(0.0 ~ 100.0) % (corresponding to the maximum frequency)	10.0%	○
FE.45	Overflow stall adjustment proportional gain Kp	0 ~ 100	20	○
FE.46	Overflow stall adjustment integral gain Ki	0 ~ 100	10	○
FE.47	Overflow stall adjustment frequency range	0.00Hz ~50.00Hz	2.00Hz	○
FE.48	reserve	-	-	○
FE.49	Overvoltage stall adjustment frequency range	0.00Hz ~50.00Hz	5.00Hz	○
FE.50	Overvoltage stall frequency adjustment proportional gain Kp	0~100	30	○
FE.51	Overvoltage stall frequency adjustment integral gain Ki	0~100	30	○
FE.52	Overvoltage stall voltage regulation proportional gain Kp	0~100	20	○

CHINT

CHINT ELECTRICS

NVF2G-S Series Inverter User's Guide

www.nicsanat.com

021-87700210



Zhejiang Chint Electrics Co., Ltd.

Add: No.1, CHINT Road, CHINT Industrial Zone, North Baixiang,
Yueqing, Zhejiang 325603, P.R.China

E-mail: global-sales@chint.com

Website: <http://en.chint.com>

0463v1635.EN

