

invt

www.nicsanat.com

021-87700210



Operation **Manual**

Goodrive20 Series VFD



SHENZHEN INVT ELECTRIC CO., LTD.

Contents

Contents	i
Chapter 1 Safety precautions.....	1
1.1 Safety definition.....	1
1.2 Warning symbols.....	1
1.3 Safety guidelines.....	2
1.3.1 Delivery and installation.....	2
1.3.2 Commissioning and operation.....	3
1.3.3 Maintenance and component replacement.....	3
1.3.4 What to do after scrapping.....	4
Chapter 2 Product overview.....	5
2.1 Quick startup.....	5
2.1.1 Unpacking inspection.....	5
2.1.2 Checking before applying.....	5
2.1.3 Environment confirmation.....	5
2.1.4 Installation confirmation.....	6
2.1.5 Basic commissioning.....	6
2.2 Product specification.....	6
2.3 Product nameplate.....	9
2.4 Model code.....	9
2.5 Rated specifications.....	10
2.6 Structure diagram.....	11
Chapter 3 Installation guidelines.....	13
3.1 Mechanical installation.....	13
3.1.1 Installation environment.....	13
3.1.2 Installation direction.....	14
3.1.3 Installation mode.....	15
3.2 Standard wiring.....	16
3.2.1 Wiring of main circuit.....	16
3.2.2 Main circuit terminals.....	17
3.2.3 Wiring of main circuit terminals.....	18
3.2.4 Wiring of control circuit.....	19
3.2.5 Control circuit terminals.....	19
3.2.6 Input/output signal connection figure.....	21
3.3 Wiring protection.....	22
3.3.1 Protect the VFD and input power cable when a short circuit occurs.....	22
3.3.2 Protect the motor and motor cables.....	23
3.3.3 Establish a bypass connection.....	23
Chapter 4 Keypad operation.....	24

4.1 Keypad introduction.....	24
4.2 Keypad display	27
4.2.1 Displaying stopped-state parameters	27
4.2.2 Displaying running-state parameters	27
4.2.3 Displaying fault information.....	27
4.2.4 Editing function codes	27
4.3 Operations on the keypad	28
4.3.1 Modifying VFD function codes	28
4.3.2 Setting a password for the VFD	29
4.3.3 Viewing VFD status.....	29
Chapter 5 Function parameter list	30
P00 group Basic functions.....	31
P01 group Start and stop control.....	38
P02 group Motor 1 parameters	45
P03 group Vector control.....	48
P04 group SVPWM control	53
P05 group Input terminals	57
P06 group Output terminals	66
P07 group HMI	69
P08 group Enhanced functions	77
P09 group PID control.....	86
P10 group Simple PLC and multi-step speed control	91
P11 group Protection parameters.....	95
P13 group SM control.....	99
P14 group Serial communication	100
P17 group Status viewing.....	103
Chapter 6 Fault tracking	107
6.1 Fault prevention.....	107
6.1.1 Periodical maintenance.....	107
6.1.2 Cooling fan	110
6.1.3 Capacitor.....	111
6.1.4 Power cable	112
6.2 Fault handling.....	112
6.2.1 Indications of alarms and faults	112
6.2.2 Fault reset	112
6.2.3 VFD faults and solutions	112
6.2.4 Other states.....	117
Chapter 7 Communication protocol	118
7.1 Brief instruction to Modbus protocol.....	118
7.2 Application of the VFD.....	118
7.2.1 2-wire RS485	118

7.2.2 RTU mode	121
7.2.3 ASCII mode	125
7.3 Command code and communication data	126
7.3.1 RTU mode	126
7.3.2 ASCII mode	129
7.4 Data address definition	133
7.4.1 Function code address format rules	133
7.4.2 Description of other function addresses in Modbus	134
7.4.3 Fieldbus ratio values	137
7.4.4 Error message response	138
7.5 Read/Write operation example	140
7.5.1 Examples of reading command 03H	140
7.5.2 Examples of writing command 06H	141
7.5.3 Examples of continuous writing command 10H	143
7.6 Common communication faults	145
Appendix A Technical data	146
A.1 Derated application	146
A.1.1 Capacity	146
A.1.2 Derating	146
A.2 CE	147
A.2.1 CE marking	147
A.2.2 Directive EMC compliance declaration	147
A.3 EMC regulations	147
A.3.1 VFDs of category C2	148
A.3.2 VFDs of category C3	148
Appendix B Dimension drawings	149
B.1 External keypad structure	149
B.2 VFD dimensions	150
Appendix C Optional peripheral accessories	155
C.1 Wiring of peripheral accessories	155
C.2 Power supply	156
C.3 Cables	157
C.3.1 Power cables	157
C.3.2 Control cables	157
C.4 Breaker and electromagnetic contactor	158
C.5 Reactors	159
C.6 Filters	161
C.6.1 C3 Filter model instruction	161
C.6.2 C3 filter	161
C.6.3 C3 filter installation instruction	163
C.6.4 C2 Filter type instruction	163

C.6.5 C2 filter model selection	164
C.7 Braking resistors	165
C.7.1 Braking resistor selection	165
C.7.2 Braking resistor installation	167
Appendix D Further information	168
D.1 Product and service queries	168
D.2 Feedback on INVT VFD manuals	168
D.3 Documents on the Internet	168

Chapter 1 Safety precautions

Please read this manual carefully and follow all safety precautions before moving, installing, operating and servicing the variable-frequency drive (VFD). If ignored, physical injury or death may occur, or damage may occur to the devices.









If any physical injury or death or damage to the devices occurs for ignoring to the safety precautions in the manual, our company will not be responsible for any damages and we are not legally bound in any manner.

1.1 Safety definition





Danger:	Serious physical injury or even death may occur if not follow related requirements
Warning:	Physical injury or damage to the devices may occur if not follow related requirements
Note:	Physical hurt may occur if not follow related requirements
Qualified electricians:	People working on the device should take part in professional electrical and safety training, receive the certification and be familiar with all steps and requirements of installation, commissioning, operating and maintaining the device to avoid any emergency.

1.2 Warning symbols

Warnings caution you about conditions which can result in serious injury or death and/or damage to the equipment, and advice on how to avoid the danger. Following warning symbols are used in this manual.

Symbols	Name	Instruction	Abbreviation
 Danger	Danger	Serious physical injury or even death may occur if related requirements are not followed.	
 Warning	Warning	Physical injury or damage to the devices may occur if related requirements are not followed.	
 Do not	Electrostatic discharge	Damage to the PCBA board may occur if not related requirements are not followed.	
 Hot sides	Hot sides	Sides of the device may become hot. Do not touch.	
Note	Note	Physical hurt may occur if related requirements are not followed.	Note

1.3 Safety guidelines

	<ul style="list-style-type: none"> ◇ Only qualified electricians are allowed to operate on the VFD. ◇ Do not carry out any wiring and inspection or changing components when the power supply is applied. Ensure all input power supply is disconnected before wiring and checking and always wait for at least the time designated on the VFD or until the DC bus voltage is less than 36V. The waiting time list is as follows. 		
	VFD model		Minimum waiting time
	1PH 220V	0.4kW–2.2kW	5 minutes
	3PH 220V	0.4kW–7.5kW	5 minutes
	3PH 380V	0.75kW–110kW	5 minutes
	<ul style="list-style-type: none"> ◇ Do not refit the VFD unauthorized; otherwise, fire, electric shock or other injury may occur. 		
	<ul style="list-style-type: none"> ◇ The base of the radiator may become hot during running. Do not touch to avoid hurt. 		
	<ul style="list-style-type: none"> ◇ The electrical parts and components inside the VFD are electrostatic. Take measurements to avoid electrostatic discharge during related operation. 		

1.3.1 Delivery and installation

	<ul style="list-style-type: none"> ◇ Please install the VFD on fire-retardant material and keep the VFD away from combustible materials. ◇ Connect the braking optional parts (braking resistors, braking units or feedback units) according to the wiring diagram. ◇ Do not operate on the VFD if there is any damage or components loss to the VFD. ◇ Do not touch the VFD with wet items or body; otherwise, electric shock may occur.
--	---

Note:

- ◇ Select appropriate moving and installing tools to ensure a safe and normal running of the VFD and avoid physical injury or death. For physical safety, the erector should take some mechanical protective measurements, such as wearing exposure shoes and working uniforms.
- ◇ Ensure to avoid physical shock or vibration during delivery and installation.
- ◇ Do not carry the VFD by its cover. The cover may fall off.
- ◇ Install away from children and other public places.
- ◇ The leakage current of the VFD may be above 3.5mA during operation. Ground with proper techniques and ensure the grounding resistor is less than 10Ω. The conductivity of PE

grounding conductor is the same as that of the phase conductor. For models higher than 30kW, the cross sectional area of the PE grounding conductor can be slightly less than the recommended area.

- ✧ R, S and T are the input terminals of the power supply, while U, V and W are the motor terminals. Please connect the input power cables and motor cables with proper techniques; otherwise, the damage to the VFD may occur.

1.3.2 Commissioning and operation

	<ul style="list-style-type: none"> ✧ Disconnect all power supplies applied to the VFD before the terminal wiring and wait for at least the designated time after disconnecting the power supply. ✧ High voltage is present inside the VFD during running. Do not carry out any operation except for the keypad setting. ✧ The VFD may start up by itself when P01.21=1. Do not get close to the VFD and motor. ✧ The VFD cannot be used as "Emergency-stop device". ✧ The VFD cannot be used to break the motor suddenly. A mechanical braking device should be provided.
--	--

Note:

- ✧ Do not switch on or off the input power supply of the VFD frequently.
- ✧ For VFDs that have been stored for a long time, check and fix the capacitance and try to run it again before utilization.
- ✧ Cover the front board before running; otherwise, electric shock may occur.



1.3.3 Maintenance and component replacement

	<ul style="list-style-type: none"> ✧ Only qualified electricians are allowed to perform the maintenance, inspection, and components replacement of the VFD. ✧ Disconnect all power supplies to the VFD before the terminal wiring. Wait for at least the time designated on the VFD after disconnection. ✧ Take measures to avoid screws, cables and other conductive matters to fall into the VFD during maintenance and component replacement.
--	---

Note:

- ✧ Please select proper torque to tighten screws.
- ✧ Keep the VFD, parts and components away from combustible materials during maintenance and component replacement.
- ✧ Do not carry out any isolation and pressure test on the VFD and do not measure the control circuit of the VFD by megameter.

1.3.4 What to do after scrapping

	⋄ There are heavy metals in the VFD. Treat it as industrial effluent.
	⋄ When the life cycle ends, the product should enter the recycling system. Dispose of it separately at an appropriate collection point instead of placing it in the normal waste stream.

Chapter 2 Product overview

2.1 Quick startup

2.1.1 Unpacking inspection

Check as follows after receiving products:

1. Check whether the packing box is damaged or dampened. If yes, contact local dealers or INVT offices.
2. Check the model identifier on the exterior surface of the packing box is consistent with the purchased model. If no, contact local dealers or INVT offices.
3. Check whether the interior surface of packing box is abnormal, for example, in wet condition, or whether the enclosure of the VFD is damaged or cracked. If yes, contact local dealers or INVT offices.
4. Check whether the name plate of the VFD is consistent with the model identifier on the exterior surface of the packing box. If no, contact local dealers or INVT offices.
5. Check whether the accessories (including user's manual and control keypad) inside the packing box are complete. If not, please contact with local dealers or INVT offices.

2.1.2 Checking before applying

Check the machine before beginning to use the VFD:

1. Check the load type to verify that there is no overload of the VFD during work and check that whether the drive needs to modify the power degree.
2. Check that the actual current of the motor is less than the rated current of the VFD.
3. Check that the control accuracy of the load is the same of the VFD.
4. Check that the incoming supply voltage is correspondent to the rated voltage of the VFD.

2.1.3 Environment confirmation

Check as follows before the actual installation and usage:

1. Check that the ambient temperature of the VFD is below 40°C. If exceeds, derate 1% for every additional 1°C. Additionally, the VFD cannot be used if the ambient temperature is above 50°C. Note: for the cabinet VFD, the ambient temperature means the air temperature inside the cabinet.
2. Check that the ambient temperature of the VFD in actual usage is above -10°C. If not, add heating facilities. Note: for the cabinet VFD, the ambient temperature means the air temperature inside the cabinet.
3. When the altitude exceeds 1000m, derate by 1% for every increase of 100m. When the altitude exceeds 3000m, consult the local INVT dealer or office for details.

4. Check that the humidity of the actual usage site is below 90% and condensation is not allowed. If not, add additional protection VFDs.
5. Check that the actual usage site is away from direct sunlight and foreign objects cannot enter the VFD. If not, add additional protective measures.
6. Check that there is no conductive dust or flammable gas in the actual usage site. If not, add additional protection to VFDs.

2.1.4 Installation confirmation

Check as follows after the installation:

1. Check that the load range of the input and output cables meet the need of actual load.
2. Check that the accessories of the VFD are correctly and properly installed. The installation cables should meet the needs of every component (including reactors, input filters, output reactors, output filters, DC reactors, braking units and braking resistors).
3. Check that the VFD is installed on non-flammable materials and the calorific accessories (reactors and braking resistors) are away from flammable materials.
4. Check that all control cables and power cables are run separately and the wire layout complies with EMC requirement.
5. Check that all grounding systems are properly grounded according to the requirements of the VFD.
6. Check that the free space during installation is sufficient according to the instructions in user's manual.
7. Check that the installation conforms to the instructions in user's manual. The drive must be installed in an upright position.
8. Check that the external connection terminals are tightly fastened and the torque is appropriate.
9. Check that there are no screws, cables and other conductive items left in the VFD. If not, get them out.

2.1.5 Basic commissioning

Complete the basic commissioning as follows before actual utilization:

1. Autotuning. If possible, de-coupled from the motor load to start dynamic autotuning. Or if not, static autotuning is available.
2. Adjust the ACC/DEC time according to the actual running of the load.
3. Commissioning the device via jogging and check that the rotation direction is as required. If not, change the rotation direction by changing the wiring of motor.
4. Set all control parameters and then operate.

2.2 Product specification

Function		Specification
Power input	Input voltage (V)	AC 1PH 220V (-15%)–240V (+10%)
		AC 3PH 220V (-15%)–240V (+10%)

Function		Specification
		AC 3PH 380V (-15%)–440V (+10%)
	Input current (A)	Refer to section 2.5 "Rated specifications"
	Input frequency (Hz)	50Hz or 60Hz; allowed range: 47–63Hz
Power output	Output voltage (V)	0–input voltage
	Output current (A)	Refer to section 2.5 "Rated specifications"
	Output power (kW)	Refer to section 2.5 "Rated specifications"
	Output frequency (Hz)	0–400Hz
Technical control feature	Control mode	SVPWM, SVC
	Motor	Asynchronous motor
	Adjustable-speed ratio	Asynchronous motor 1: 100 (SVC)
	Speed control accuracy	±0.2% (SVC)
	Speed fluctuation	± 0.3% (SVC)
	Torque response	<20ms (SVC)
	Torque control accuracy	10%
	Starting torque	0.5Hz/150% (SVC)
Running control feature	Overload capability	150% of rated current: 1 minute 180% of rated current: 10 seconds 200% of rated current: 1 second
	Frequency setting method	Digital setting, analog setting, pulse frequency setting, multi-step speed running setting, simple PLC setting, PID setting, Modbus communication setting Shift between the set combination and set channel.
	Auto-adjustment of the voltage	Keep a stable voltage automatically when the grid voltage transients
	Fault protection	Provide comprehensive fault protection functions: overcurrent, overvoltage, undervoltage, overheating, phase loss and overload, etc.
Peripheral interface	Start after speed tracking	Smoothing starting for running motor
	Analog input	1 (AI2) 0–10V/0–20mA and 1 (AI3) -10–10V
	Analog output	2 (AO1, AO2) 0–10V/0–20mA
	Digital input	4 common inputs, and max. frequency: 1kHz; 1 high speed input, and max. frequency: 50kHz
	Digital output	1 Y1 terminal output

Function		Specification
	Relay output	2 programmable relay outputs RO1A NO, RO1B NC, RO1C common terminal RO2A NO, RO2B NC, RO2C common terminal Contact capacity: 3A/AC250V, 1A/DC30V
Others	DC reactor	DC reactors have been built in the 18.5kW and higher VFD models as standard configuration.
	Installation mode	Wall and rail installation for the 1PH 220V/3PH 380V ($\leq 2.2\text{KW}$) and 3PH 220V ($\leq 0.75\text{KW}$) VFD models Wall and flange installation for the 3PH 380V ($\geq 4\text{kW}$) and 3PH 220V ($\geq 1.5\text{kW}$) VFD models
	Braking unit	Braking units have been built in the 37kW and lower VFD models as standard configuration. Braking units have been built in the 45–110kW VFD models as optional configuration.
	EMI filter	3PH 380V ($\geq 4\text{kW}$) and 3PH 220V ($\geq 1.5\text{kW}$) VFD models can satisfy the requirements of IEC 61800-3 C3, other models can satisfy the requirements of IEC 61800-3 C3 by installing optional external filter. The whole series can satisfy the requirements of IEC 61800-3 C2 by installing optional external filter.
	Ambient environment	-10 to 50°C, derate 1% for every additional 1°C when above 40°C.
	Altitude	When the altitude exceeds 1000m, derate by 1% for every increase of 100m. When the altitude exceeds 3000m, consult the local INVT dealer or office for details.
	Protective degree	IP20 Note: The VFD with plastic casing should be installed in metal distribution cabinet, which conforms to IP20 and of which the top conforms to IP3X.
	Pollution level	Level 2
	Safety	Meet the requirement of CE
	Cooling mode	Forced air cooling.

2.3 Product nameplate

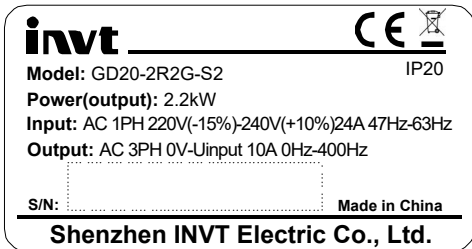

Figure 2-1 Product nameplate

Note: This is a nameplate example of a standard VFD product. The CE/TUV/IP20 marking on the top right will be marked according to actual certification conditions.

2.4 Model code

The model code contains product information. You can find the model code on the VFD nameplate or simplified nameplate.

GD20 - 2R2G - 4

① ② ③

Figure 2-2 Product model

Key	No.	Detailed description	Detailed content
Abbreviation of product series	①	Abbreviation of product series	GD20: Goodrive20 series VFD
Rated power	②	Power range + Load type	2R2: 2.2kW G: Constant torque load
Voltage class	③	Voltage class	S2: AC 1PH 220V (-15%)–240V (+10%) 2: AC 3PH 220V (-15%)–240V (+10%) 4: AC 3PH 380V (-15%)–440V (+10%)

Note:

Braking units have been built in the 37kW and lower VFD models as standard configuration. Braking units are not standard configuration for the 45–110kW VFD models. (If you want to use braking units for these models, add suffix "-B" at the end of the model codes in your purchase orders, for example, GD20-045G-4-B.)

2.5 Rated specifications

Model	Voltage class	Rated output power (kW)	Rated input current (A)	Rated output current (A)
GD20-0R4G-S2	1PH 220V	0.4	6.5	2.5
GD20-0R7G-S2		0.75	9.3	4.2
GD20-1R5G-S2		1.5	15.7	7.5
GD20-2R2G-S2		2.2	24	10
GD20-0R4G-2	3PH 220V	0.4	3.7	2.5
GD20-0R7G-2		0.75	5	4.2
GD20-1R5G-2		1.5	7.7	7.5
GD20-2R2G-2		2.2	11	10
GD20-004G-2		4	17	16
GD20-5R5G-2		5.5	21	20
GD20-7R5G-2		7.5	31	30
GD20-0R7G-4	3PH 380V	0.75	3.4	2.5
GD20-1R5G-4		1.5	5.0	4.2
GD20-2R2G-4		2.2	5.8	5.5
GD20-004G-4		4	13.5	9.5
GD20-5R5G-4		5.5	19.5	14
GD20-7R5G-4		7.5	25	18.5
GD20-011G-4		11	32	25
GD20-015G-4		15	40	32
GD20-018G-4		18.5	47	38
GD20-022G-4		22	51	45
GD20-030G-4		30	70	60
GD20-037G-4		37	80	75
GD20-045G-4		45	98	92
GD20-055G-4		55	128	115
GD20-075G-4		75	139	150
GD20-090G-4		90	168	180
GD20-110G-4	110	201	215	

2.6 Structure diagram

The following figure shows the structure of the VFD (3PH 380V, $\leq 2.2\text{kW}$) (using the 0.75kW VFD model as the example).

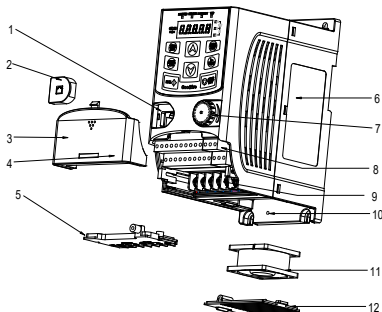

Figure 2-3 Product structure (3PH 380V, $\leq 2.2\text{kW}$)

Serial No.	Name	Description
1	External keypad port	Connect the external keypad
2	Port cover	Protect the external keypad port
3	Cover	Protect the internal parts and components
4	Hole for the sliding cover	Fix the sliding cover
5	Trunking board	Protect the inner components and fix the cables of the main circuit
6	Product nameplate	See section 2.3 "Product nameplate" for detailed information
7	Potentiometer knob	Refer to Chapter 4 "Keypad operation"
8	Control terminals	See Chapter 3 "Installation guidelines" for detailed information
9	Main circuit terminals	See Chapter 3 "Installation guidelines" for detailed information
10	Screw hole	Fix the fan cover and fan
11	Cooling fan	See Chapter 6 "Fault tracking" for detailed information
12	Fan cover	Protect the fan
13	Bar code	The same as the bar code on the name plate Note: The bar code is on the middle shell which is under the cover

Serial No.	Name	Description
Note: In above figure, the screws at 4 and 10 are provided with packaging and specific installation depends on the requirements of customers.		

The following figure shows the structure of the VFD (3PH 380V, $\geq 4\text{kW}$) (using the 4kW VFD model as the example).

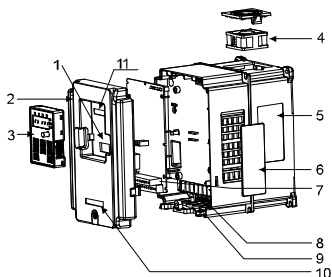



Figure 2-4 Product structure (3PH 380V, $\geq 4\text{kW}$)

Serial No.	Name	Description
1	External keypad port	Connect the external keypad
2	Cover	Protect the internal parts and components
3	Keypad	Refer to Chapter 4 "Keypad operation"
4	Cooling fan	See Chapter 6 "Fault tracking" for detailed information
5	Product nameplate	See section 2.3 "Product nameplate" for detailed information
6	Cover for the heat emission hole	Optional, enhancement of the protective degree. It is necessary to derate the VFD because the internal temperature is increasing
7	Control terminals	See Chapter 3 "Installation guidelines" for detailed information
8	Main circuit terminals	See Chapter 3 "Installation guidelines" for detailed information
9	The cable entry of the main circuit	Fix the cables
10	Simple nameplate	Refer to section 2.4 "Model code"
11	Bar code	The same as the bar code on the name plate Note: The bar code is on the middle shell which is under the cover

Chapter 3 Installation guidelines

The chapter describes the mechanical installation and electric installation of the VFD.

	<ul style="list-style-type: none"> ✧ Only qualified electricians are allowed to carry out what described in this chapter. Please operate as the instructions in Chapter 1 "Safety precautions". Ignoring these may cause physical injury or death or damage to the devices. ✧ Ensure the power supply of the VFD is disconnected during the operation. Wait for at least the time designated after the disconnection if the power supply is applied. ✧ The installation and design of the VFD should be complied with the requirement of the local laws and regulations in the installation site. If the installation infringes the requirement, our company will exempt from any responsibility. Additionally, if users do not comply with the suggestion, some damage beyond the assured maintenance range may occur.
--	--

3.1 Mechanical installation

3.1.1 Installation environment

The installation environment is the safeguard for a full performance and long-term stable functions of the VFD. Check the installation environment as follows:

Environment	Conditions
Installation site	Indoor
Environment temperature	<ul style="list-style-type: none"> ✧ -10°C–$+50^{\circ}\text{C}$, and the temperature changing rate is less than $0.5^{\circ}\text{C}/\text{minute}$. ✧ If the ambient temperature of the VFD is above 40°C, derate 1% for every additional 1°C. ✧ It is not recommended to use the VFD if the ambient temperature is above 50°C. ✧ In order to improve the reliability of the device, do not use the VFD if the ambient temperature changes frequently. ✧ Please provide cooling fan or air conditioner to control the internal ambient temperature below the required one if the VFD is used in a close space such as in the control cabinet. ✧ When the temperature is too low, if the VFD needs to restart to run after a long stop, it is necessary to provide an external heating device to increase the internal temperature; otherwise, damage to the devices may occur.
Humidity	<ul style="list-style-type: none"> ✧ $\text{RH} \leq 90\%$ ✧ No condensation is allowed.

Environment	Conditions
Storage temperature	-40°C~+70°C, and the temperature changing rate is less than 1°C/minute.
Running environment condition	The installation site should meet the following requirements. ✧ Away from electromagnetic radiation sources. ✧ Away from oil mist, corrosive gases and combustible gases. ✧ Ensure foreign object like metal powder, dust, oil and water will not fall into the VFD (do not install the VFD onto combustible object like wood). ✧ Away from radioactive substance and combustible objects. ✧ Away from harmful gases and liquids. ✧ Low salt content. ✧ No direct sunlight.
Altitude	✧ Below 1000m. ✧ When the altitude exceeds 1000m, derate by 1% for every increase of 100m. ✧ When the altitude exceeds 3000m, consult the local INVT dealer or office for details.
Vibration	Max. vibration acceleration: 5.8m/s^2 (0.6g)
Installation direction	The VFD should be installed on an upright position to ensure sufficient cooling effect.

Note:

- ✧ Goodrive20 series VFDs should be installed in a clean and ventilated environment according to enclosure classification.
- ✧ Cooling air must be clean, free from corrosive materials and electrically conductive dust.

3.1.2 Installation direction

The VFD may be installed on the wall or in a cabinet.

The VFD needs be installed in the vertical position. Check the installation site according to the following requirements. Refer to Appendix B "Dimension drawings" in the appendix for frame details.

3.1.3 Installation mode

1. Wall and rail mounting for the VFDs (1PH 220V/3PH 380V, $\leq 2.2\text{KW}$ and 3PH 220V, $\leq 0.75\text{KW}$)

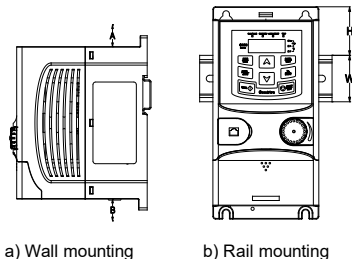

Figure 3-1 Installation mode

Note: The minimum space of A and B is 100mm if H is 36.6mm and W is 35.0mm.

2. Wall and flange mounting for the VFDs (3PH 380V, $\geq 4\text{KW}$ and 3PH 220V, $\geq 1.5\text{KW}$)

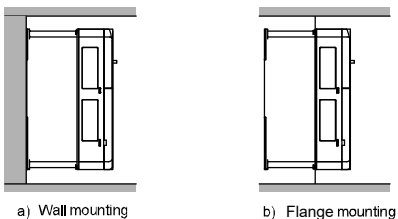

Figure 3-2 Installation mode

- (1) Locate the position of the installation hole.
- (2) Fix the screw or nut on the located position.
- (3) Put the VFD against the wall.
- (4) Tighten up the screws.

3.2 Standard wiring

3.2.1 Wiring of main circuit

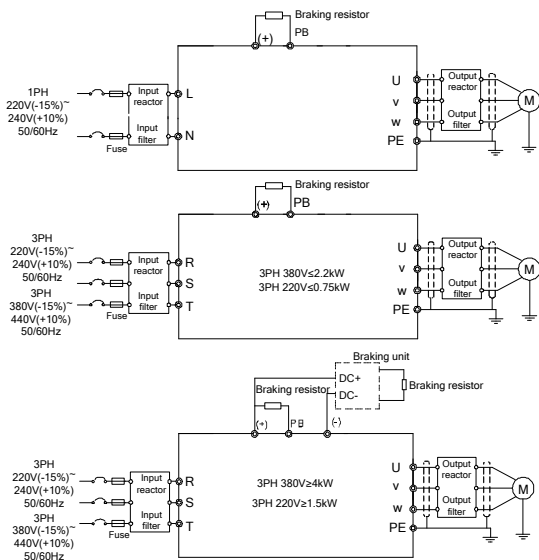

Figure 3-3 Wiring of main circuit

Note:

- ◇ The fuse, braking resistor, input reactor, input filter, output reactor, output filter are optional parts. Please refer to Appendix C "Optional peripheral accessories" for detailed information.
- ◇ Remove the yellow warning labels of PB, (+) and (-) on the terminals before connecting the braking resistor; otherwise, poor connection may occur.

3.2.2 Main circuit terminals

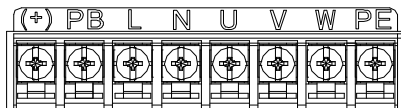

Figure 3-4 1PH terminals of main circuit (1PH)

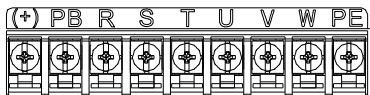

Figure 3-5 3PH terminals of main circuit (220V, $\leq 0.75\text{kW}$, and 380V, $\leq 2.2\text{kW}$)

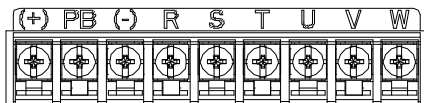

Figure 3-6 3PH terminals of main circuit (220V, $\leq 1.5\text{kW}$, and 380V, 4–22kW)



Figure 3-7 3PH terminals of main circuit (30–37kW)

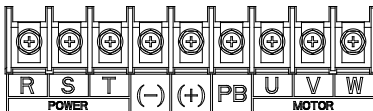

Figure 3-8 3PH terminals of main circuit (45–110kW)

Terminal	Function
L, N	1PH AC input terminals which are generally connected with the power supply.
R, S, T	3PH AC input terminals which are generally connected with the power supply.
PB, (+)	External dynamic braking resistor terminal
(+), (-)	Input terminal of the DBU or DC bus

Terminal	Function
U, V, W	3PH AC output terminals which are generally connected with the motor.
PE	Protective grounding terminal

Note:

- ✧ It is not recommended to use asymmetrically motor cables. If there is a symmetrically grounding conductor in the motor cable in addition to the conductive shield, connect the grounding conductor to the grounding terminal at the VFD and motor ends.
- ✧ Route the motor cable, input power cable and control cables separately.
- ✧ DC bus circuits of GD series VFDs cannot be connected in parallel with those of CH series VFDs.
- ✧ When DC bus circuits of GD series VFDs are connected in parallel with those of CH series VFDs, the power of these VFDs must be the same, and power-on and power-off shall be conducted simultaneously.
- ✧ For parallel connection of DC bus circuits, current sharing on the input side of the VFD shall be considered during wiring. It is recommended to configure an equalizing reactor.

3.2.3 Wiring of main circuit terminals

1. Connect the ground wire of the input power cable to the ground terminal (PE) of the VFD, connect the 3PH input cable to the terminals R, S, and T, and fasten them up.
2. Connect the grounding wire of the motor cable to the ground terminal of the VFD, and connect the 3PH motor cable to the terminals U, V, and W, and fasten them up.
3. Connect the braking resistor and other accessories that are equipped with cables to the specified positions.
4. Fasten all the cables outside of the VFD mechanically, if possible.

3.2.4 Wiring of control circuit

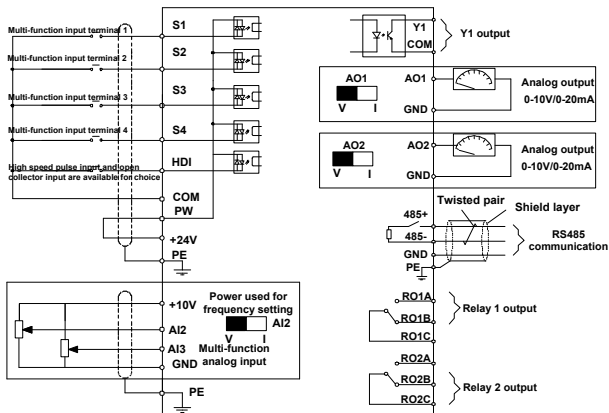

Figure 3-9 Wiring of control circuit

3.2.5 Control circuit terminals

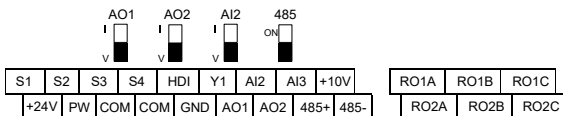

Figure 3-10 Control circuit terminal diagram for less than 4kW VFDs

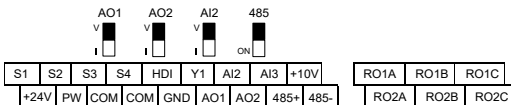

Figure 3-11 Control circuit terminal diagram for 4kW and higher VFDs

Note: The rectangular black mark indicates the shorting cap or DIP switch ex-factory selection position.

Type	Terminal name	Function description	Technical specifications
Communication	485+	485 communication	485 communication interface
	485-		
Digital input/output	S1	Digital input	1. Internal impedance: 3.3kΩ 2. 12–30V voltage input is available 3. The terminal is the dual-direction input terminal 4. Max. input frequency: 1kHz
	S2		
	S3		
	S4		
	HDI	High frequency input channel	1. Except for S1–S4, this terminal can be used as high frequency input channel. 2. Max input frequency: 50kHz 3. Duty cycle: 30%–70%
	PW	Digital power supply	External power input terminal for digital input circuits Voltage range: 12–30V
	Y1	Digital output	1. Switch capacity: 50 mA/30V; 2. Range of output frequency: 0–1kHz.
COM	Common terminal of open collector output		
24V power supply	+24V	24V power supply	External 24V±10% power supply and the maximum output current is 200mA. Generally used as the operation power supply of digital input and output or external sensor power supply.
	COM		
Analog input/output	+10V	External 10V reference power supply	10V reference power supply; Max. output current: 50 mA; As the adjusting power supply of the external potentiometer; Potentiometer resistance: 5kΩ above.
	AI2	Analog input	1. Input range: AI2 voltage and current can be chosen: 0–10V/0–20mA; AI3: -10V–+10V. 2. Input impedance: voltage input: 20kΩ; current input: 500Ω. 3. Voltage or current input can be set by dip switch. 4. Resolution: the minimum AI2/AI3 is 10mV/20mV when 10V corresponds to 50Hz.
	AI3		

Type	Terminal name	Function description	Technical specifications
	GND	Analog reference ground	Analog reference ground
	AO1	Analog output	1. Output range: 0–10V or 0–20mA. 2. The voltage or the current output is depended on the dip switch. 3. Deviation \pm 1%, 25°C when full range.
AO2			
Relay output	RO1A	Relay 1 NO contact	Relay output RO1 RO1A is in the NO state, RO1B is in the NC state, and RO1C is the common terminal.
	RO1B	Relay 1 NC contact	
	RO1C	Relay 1 common contact	
	RO2A	Relay 2 NO contact	Relay output RO2 RO2A is in the NO state, RO2B is in the NC state, and RO2C is the common terminal. Contact capacity: 3A/AC250V, 1A/DC30V
	RO2B	Relay 2 NC contact	
	RO2C	Relay 2 common contact	

3.2.6 Input/output signal connection figure

You can select the NPN/PNP mode and internal/external power through the U-shaped jumper. NPN internal mode is adopted by default.

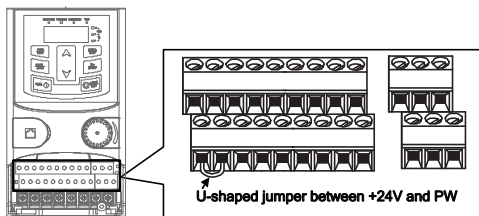

Figure 3-12 U-shaped jumper

If input signal comes from NPN transistors, set the U-shaped jumper based on the power used according to the following figure.

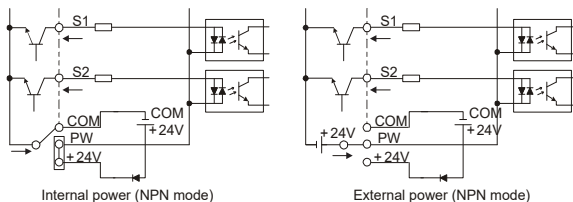

Figure 3-13 NPN mode

If input signal comes from PNP transistors, set the U-shaped jumper based on the power used according to the following figure.

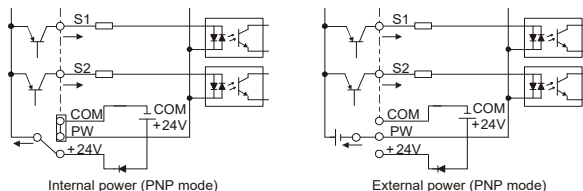

Figure 3-14 PNP mode

3.3 Wiring protection

3.3.1 Protect the VFD and input power cable when a short circuit occurs

Protect the VFD and input power cable in short circuit situations and against thermal overload. Arrange the protection according to the following guidelines.

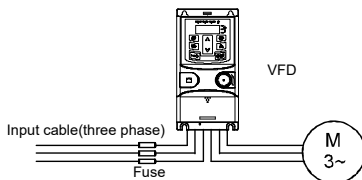

Figure 3-15 Fuse configuration

Note: Select the fuse as the manual indicated. The fuse will protect the input power cable from damage in short-circuit situations. It will protect the surrounding devices when the internal of the VFD is short circuited.

3.3.2 Protect the motor and motor cables

If the motor cable is selected based on the rated current of the VFD, the VFD can protect the motor cable and motor when a short circuit occurs. The VFD provides the motor thermal overload protection function, which can protect the motor, and lock the output and cut off the current when necessary.



- ✧ If the VFD is connected to multiple motors, a separate thermal overload switch or a circuit breaker must be used for protecting each cable and motor. These devices may require a separate fuse to cut off the short-circuit current.

3.3.3 Establish a bypass connection

It is necessary to set power frequency and variable frequency conversion circuits for the assurance of continuous normal work of the VFD if faults occur in some significant situations. In some special situations, for example, if it is only used in soft start, the VFD can be converted into power frequency running after starting and some corresponding bypass should be added.



- ✧ Never connect the supply power to the VFD output terminals U, V and W. Power line voltage applied to the output can result in permanent damage to the VFD.

If frequent shifting is required, employ mechanically connected switches or contactors to ensure that the motor terminals are not simultaneously connected to the input power cable and the output terminal of the VFD.

Chapter 4 Keypad operation

4.1 Keypad introduction

You can use the keypad to control the start and stop, read status data, and set parameters of the VFD. The keypad can be externally connected to the VFD, which requires a network cable with a standard RJ45 crystal head as the connection cable.

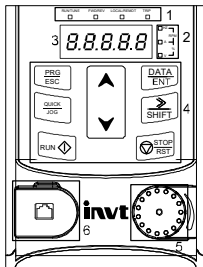

Figure 4-1 Film-type keypad

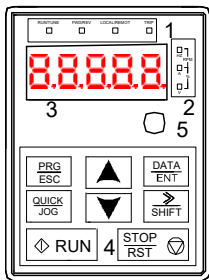
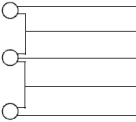









Figure 4-2 External keypad

Note:

- ◇ A film-type keypad is a standard configuration for the VFD models of 1PH 220V/3PH 380V ($\leq 2.2\text{kW}$) and 3PH 220V ($\leq 0.75\text{kW}$). An external keypad is a standard configuration for the VFD models of 3PH 380V ($\geq 4\text{kW}$) and 3PH 220V ($\geq 1.5\text{kW}$).
- ◇ In addition, if you need, an external keypad (an optional part) can be provided (including the external keypads with and without the function of parameter copying).

Serial No.	Name	Description							
1	State LED	RUN/TUNE	LED off means that the VFD is in the stopping state; LED blinking means the VFD is in the parameter autotuning state; LED on means the VFD is in the running state.						
		FWD/REV	FED/REV LED LED off means the VFD is in the forward rotation state; LED on means the VFD is in the reverse rotation state.						
		LOCAL/REMOT	LED for keypad operation, terminals operation and remote communication control LED off means that the VFD is in the keypad operation state; LED blinking means the VFD is in the terminals operation state; LED on means the VFD is in the remote communication control state.						
		TRIP	LED for faults LED on when the VFD is in the fault state; LED off in normal state; LED blinking means the VFD is in the pre-alarm state.						
2	Unit LED	Mean the unit displayed currently							
			Hz	Frequency unit					
			RPM	Rotating speed unit					
			A	Current unit					
			%	Percentage					
		V	Voltage unit						
3	Digital display zone	5-figure LED display displays various monitoring data and alarm code such as set frequency and output frequency.							
		Display	Means	Display	Means	Display	Means	Display	Means
		0	0	1	1	2	2	3	3
		4	4	5	5	6	6	7	7
		8	8	9	9	A	A	b	B
		C	C	d	D	E	E	F	F
		H	H	I	I	L	L	n	N
		n	n	0	o	P	P	r	r
S	S	t	t	U	U	v	v		
.	.	-	-						
4	Buttons		Programming key	Enter or escape from the first level menu and remove the parameter quickly					

Serial No.	Name	Description	
			Entry key Enter the menu step-by-step Confirm parameters
			UP key Increase data or function code progressively
			DOWN key Decrease data or function code progressively
			Right-shift key Move right to select the displaying parameter circularly in stopping and running mode. Select the parameter modifying digit during the parameter modification
			Run key This key is used to operate on the VFD in key operation mode
			Stop/ Reset key This key is used to stop in running state and it is limited by function code P07.04 This key is used to reset all control modes in the fault alarm state
			Quick key The function of this key is confirmed by function code P07.02 .
5	Analog potentiometer	<p>AI1, When the external common keypad (without the function of parameter copy) is valid, the difference between the local keypad AI1 and the external keypad AI1 is:</p> <p>When the external keypad AI1 is set to the Min. value, the local keypad AI1 will be valid and P17.19 will be the voltage of the local keypad AI1; otherwise, the external keypad AI1 will be valid and P17.19 will be the voltage of the external keypad AI1.</p> <p>Note: If the external keypad AI1 is frequency reference source, adjust the local potentiometer AI1 to 0V/0mA before starting the VFD.</p>	
6	Keypad port	<p>External keypad port. When the external keypad with the function of parameter copying is valid, the local keypad LED is off. When the external keypad without the function of parameter copying is valid, the local and external keypad LEDs are on.</p> <p>Note: Only the external keypad which has the function of parameters copy owns the function of parameters copy, other keypads do not have. (only for the VFDs≤2.2kW)</p>	

4.2 Keypad display

The keypad of Goodrive20 series VFD displays the stopped-state parameters, running-state parameters, function parameter editing status, and fault alarm status.

4.2.1 Displaying stopped-state parameters

When the VFD is in stopped state, the keypad displays stopped-state parameters.

In the stopped state, parameters in various states can be displayed. You can determine which parameters are displayed by setting the binary bits of P07.07. For definitions of the bits, see the description of P07.07.

In stopping state, there are 14 parameters that can be selected for display, including set frequency, bus voltage, input terminal status, output terminal status, PID reference value, PID feedback value, torque setting, AI1, AI2, AI3, high-speed pulse HDI frequency, PLC and the current step of multi-step speed, pulse counting value, length value. P07.07 can select the parameter to be displayed or not by bit, and you can press **▶/SHIFT** to shift selected parameters from left to right or press **QUICK/JOG** to shift selected parameters from right to left.

4.2.2 Displaying running-state parameters

After receiving a valid running command, the VFD enters the running state, and the keypad displays running-state parameters, with the **RUN/TUNE** indicator on. The on/off state of the **FWD/REV** indicator is determined by the current running direction.

In running state, there are 24 parameters that can be selected for display, including running frequency, set frequency, bus voltage, output voltage, output current, running speed, output power, output torque, PID reference value, PID feedback value, input terminal status, output terminal status, torque setting, length value, PLC and the current step of multi-step speed, AI1, AI2, AI3, high-speed pulse HDI frequency, motor overload percentage, VFD overload percentage, ramp reference value, linear speed, and AC input current. P07.05 and P07.06 can select the parameter to be displayed or not by bit, and you can press **▶/SHIFT** to shift selected parameters from left to right or press **QUICK/JOG** to shift selected parameters from right to left.

4.2.3 Displaying fault information

After detecting a fault signal, the VFD enters the fault alarm state immediately, the fault code blinks on the keypad, and the **TRIP** indicator is on. You can perform fault reset by using the **STOP/RST** key, control terminals, or communication commands.

If the fault persists, the fault code is continuously displayed.

4.2.4 Editing function codes

You can press the **PRG/ESC** key to enter the editing mode in stopped, running, or fault alarm state (if a user password is used, see the description of P07.00). The editing mode contains

two levels of menus in the following sequence: Function code group or function code number → Function code setting. You can press the **DATA/ENT** key to enter the function parameter display interface. On the function parameter display interface, you can press the **DATA/ENT** key to save parameter settings or press the **PRG/ESC** key to exit the parameter display interface.



Figure 4-3 Status display

4.3 Operations on the keypad

You can operate the VFD by using the keypad. For details about function code descriptions, see the function code list.

4.3.1 Modifying VFD function codes

The VFD provides three levels of menus, including:

1. Function code group number (level-1 menu)
2. Function code number (level-2 menu)
3. Function code setting (level-3 menu)

Note: When performing operations on the level-3 menu, you can press the **PRG/ESC** or **DATA/ENT** key to return to the level-2 menu. If you press the **DATA/ENT** key, the set value of the parameter is saved to the control board first, and then the level-2 menu is returned, displaying the next function code. If you press the **PRG/ESC** key, the level-2 menu is returned directly, without saving the set value of the parameter, and the current function code is displayed.

If you enter the level-3 menu but the parameter does not have a digit blinking, the parameter cannot be modified due to either of the following reasons:

- 1) It is read only. Read-only parameters include actual detection parameters and running record parameters.
- 2) It cannot be modified in running state and can be modified only in stopped state.

Example: Change the value of P00.01 from 0 to 1.

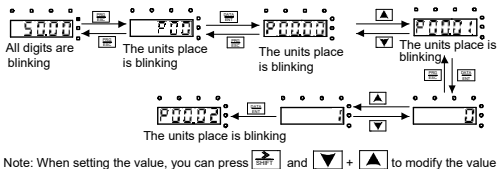

Figure 4-4 Modifying a parameter

4.3.2 Setting a password for the VFD

Goodrive20 series VFDs provide password protection function to users. Set P07.00 to gain the password and the password protection becomes effective 1 minute later after retreating from the function code editing state. Press **PRG/ESC** again to the function code editing state, "0.0.0.0.0" will be displayed. Unless using the correct password, you cannot enter it.

To disable the password protection function, you need only to set P07.00 to 0.

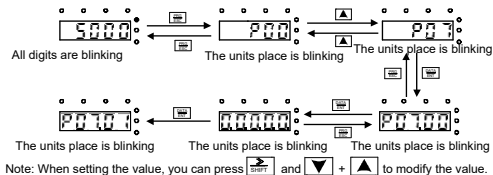

Figure 4-5 Setting a password

4.3.3 Viewing VFD status

The VFD provides group P17 for status viewing. You can enter group P17 for viewing.

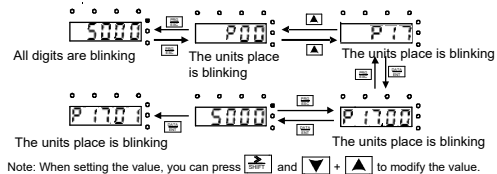

Figure 4-6 Viewing a parameter

Chapter 5 Function parameter list

The function parameters of Goodrive20 series VFDs have been divided into 30 groups (P00–P29) according to the function, of which P18–P28 are reserved. Each function group contains certain function codes. A three-level menu style is applied to function codes. For example, "[P08.08](#)" indicates the 8th function code in the P8 group. The P29 group consist of factory function parameters, which are user inaccessible.

The function group numbers correspond to the level-1 menus, the function codes correspond to the level-2 menus, and the function parameters correspond to the level-3 menus.

1. The content of the function code table is as follows:

Column 1 "Function code": Code of the function group and parameter.

Column 2 "Name": Full name of the function parameter.

Column 3 "Description": Detailed description of the function parameter.

Column 4 "Default": Initial value set in factory.

Column 5 "Modify": Whether the function parameter can be modified, and conditions for the modification.

"○" indicates that the value of the parameter can be modified when the VFD is in the stop or running state.

"◎" indicates that the value of the parameter cannot be modified when the VFD is in the running state.

"●" indicates that the value of the parameter is detected and recorded, and cannot be modified.

(The VFD automatically checks and constrains the modification of parameters, which helps prevent incorrect modifications.)

2. The parameters adopt the decimal system (DEC). If the hexadecimal system is adopted, the data in each digit is independent from each other during parameter editing. The values of some of the digits can be hexadecimal (0–F).

3. "Default" indicates the factory setting of the function parameter. If the value of the parameter is detected or recorded, the value cannot be restored to the factory setting.

4. To better protect the parameters, the VFD provides the password protection function. After a password is set (that is, [P07.00](#) is set to a non-zero value), "0.0.0.0" is displayed when you press the PRG/ESC key to enter the function code editing interface. You need to enter the correct user password to enter the interface. For the factory parameters, you need to enter the

correct factory password to enter the interface. (You are advised not to modify the factory parameters. Incorrect parameter setting may cause operation exceptions or even damage to the VFD.). When the system is not locked due to password protection, you can modify the user password, and the last value entered is the user password. If [P07.00](#) is set to 0, the user password is canceled. If [P07.00](#) is set to a non-zero value, the parameters are protected through the user password at power-on. When you modify function parameters through serial communication, the user password provides the same functions.

Note: The VFD automatically checks and constrains the modification of parameters, which helps prevent incorrect modifications.

P00 group Basic functions

Function code	Name	Description	Default	Modify
P00.00	Speed control mode	<p>0: SVC 0 There is no need to install encoders. Suitable in applications which need low frequency, big torque for high accuracy of rotating speed and torque control. Relative to mode 1, it is more suitable for the applications which need small power.</p> <p>1: SVC 1 1 is suitable in high performance cases with the advantage of high accuracy of rotating speed and torque. It does not need to install pulse encoder.</p> <p>2: SVPWM control 2 is suitable in applications which do not need high control accuracy, such as the load of fan and pump. One VFD can drive multiple motors.</p> <p>Note: Carry out motor parameter autotuning before adopting vector mode.</p>	2	⊙
P00.01	Channel of running commands	<p>Select the channel of VFD running commands.</p> <p>The control command of the VFD includes: start, stop, forward/reverse rotating, jogging and fault reset.</p> <p>0: Keypad ("LOCAL/REMOT" light off) Carry out the command control by RUN.</p>	0	○

Function code	Name	Description	Default	Modify
		<p>STOP/RST on the keypad. Set the multi-function key QUICK/JOG to FWD/REVC shifting function (P07.02=3) to change the running direction; press RUN and STOP/RST simultaneously in running state to make the VFD coast to stop.</p> <p>1: Terminal ("LOCAL/REMOT") flickering) Carry out the running command control by the forward rotation, reverse rotation and forward jogging and reverse jogging of the multi-function terminals</p> <p>2: Communication ("LOCAL/REMOT" on); The running command is controlled by the upper monitor via communication</p>		
P00.03	Max. output frequency	<p>The parameter is used to set the max. output frequency of the VFD. It is the basis of frequency setup and the acceleration/deceleration.</p> <p>Setting range: P00.04–630.00Hz</p>	50.00Hz	⊙
P00.04	Upper limit of the running frequency	<p>The upper limit of the running frequency is the upper limit of the output frequency of the VFD which is lower than or equal to the maximum frequency.</p> <p>Setting range: P00.05–P00.03 (max output frequency)</p>	50.00Hz	⊙
P00.05	Lower limit of the running frequency	<p>The lower limit of the running frequency is that of the output frequency of the VFD.</p> <p>The VFD runs at the lower limit frequency if the set frequency is lower than the lower limit.</p> <p>Note: Max. output frequency ≥ Upper limit frequency ≥ Lower limit frequency</p> <p>Setting range: 0.00Hz–P00.04 (Upper limit of the running frequency)</p>	0.00Hz	⊙
P00.06	A frequency command selection	<p>Note: A frequency and B frequency cannot set as the same frequency given method.</p> <p>The frequency source can be set by P00.09.</p>	0	○

Function code	Name	Description	Default	Modify
P00.07	B frequency command selection	<p>0: Keypad data setting Modify the value of function code P00.10 (frequency set through keypad) to modify the frequency by the keypad.</p> <p>1: Analog AI1 setting (corresponding keypad potentiometer)</p> <p>2: Analog AI2 setting (corresponding terminal AI2)</p> <p>3: Analog AI3 setting (corresponding terminal AI3)</p> <p>Set the frequency by analog input terminals. Goodrive20 series VFDs provide 3 channels analog input terminals as the standard configuration, of which AI1 is adjusting through analog potentiometer, while AI2 is the voltage/current option (0–10V/0–20mA) which can be shifted by jumpers; while AI3 is voltage input (-10V+10V).</p> <p>Note: when analog AI2 select 0–20 mA input, the corresponding voltage of 20mA is 10V.</p> <p>100.0% of the analog input setting corresponds to the maximum frequency (function code P00.03) in forward direction and -100.0% corresponds to the maximum frequency in reverse direction (function code P00.03)</p> <p>4: High-speed pulse HDI setting The frequency is set by high-speed pulse terminals. Goodrive20 series VFDs provide 1 high speed pulse input as the standard configuration. The pulse frequency range is 0.00–50.00 kHz.</p> <p>100.0% of the high speed pulse input setting corresponds to the maximum frequency in forward direction (function code P00.03) and -100.0% corresponds to the maximum frequency in reverse direction (function code P00.03).</p> <p>Note: The pulse setting can only be input by</p>	2	○

Function code	Name	Description	Default	Modify
		<p>multi-function terminals HDI. Set P05.00 (HDI input selection) to high speed pulse input.</p> <p>5: Simple PLC program setting The VFD runs at simple PLC program mode when P00.06=5 or P00.07=5. Set P10 (simple PLC and multi-step speed control) to select the running frequency running direction, ACC/DEC time and the keeping time of corresponding step. See the function description of P10 for detailed information.</p> <p>6: Multi-step speed running setting The VFD runs at multi-step speed mode when P00.06=6 or P00.07=6. Set P05 to select the current running step, and set P10 to select the current running frequency. The multi-step speed has the priority when P00.06 or P00.07 does not equal to 6, but the setting step can only be the 1–15 step. The setting step is 1–15 if P00.06 or P00.07 equals to 6.</p> <p>7: PID control setting The running mode of the VFD is process PID control when P00.06=7 or P00.07=7. It is necessary to set P09. The running frequency of the VFD is the value after PID effect. See P09 for the detailed information of the preset source, preset value and feedback source of PID.</p> <p>8: Modbus communication setting The frequency is set by Modbus communication. See P14 for detailed information.</p> <p>9–11: Reserved</p>		
P00.08	B frequency command reference selection	<p>0: Maximum output frequency, 100% of B frequency setting corresponds to the maximum output frequency</p> <p>1: A frequency command, 100% of B frequency setting corresponds to the</p>	0	○

Function code	Name	Description	Default	Modify
		maximum output frequency. Select this setting if it needs to adjust on the base of A frequency command.		
P00.09	Combination of the setting source	<p>0: A, the current frequency setting is A frequency command</p> <p>1: B, the current frequency setting is B frequency command</p> <p>2: A+B, the current frequency setting is A frequency command + B frequency command</p> <p>3: A-B, the current frequency setting is A frequency command - B frequency command</p> <p>4: Max (A, B): The bigger one between A frequency command and B frequency is the set frequency.</p> <p>5: Min (A, B): The lower one between A frequency command and B frequency is the set frequency.</p> <p>Note: The combination manner can be shifted by P05 (terminal function)</p>	0	<input type="radio"/>
P00.10	Frequency set through keypad	<p>When A and B frequency commands are selected as "keypad setting", this parameter will be the initial value of VFD reference frequency.</p> <p>Setting range: 0.00Hz–P00.03 (max. output frequency)</p>	50.00Hz	<input type="radio"/>
P00.11	ACC time 1	ACC time means the time needed if the VFD speeds up from 0Hz to the max one (P00.03).	Depend on model	<input type="radio"/>
P00.12	DEC time 1	<p>DEC time means the time needed if the VFD speeds down from the max output frequency to 0Hz (P00.03).</p> <p>Goodrive20 series VFDs have four groups of ACC/DEC time which can be selected by P05. The factory default ACC/DEC time of the VFD is the first group.</p> <p>Setting range of P00.11 and P00.12: 0.0–3600.0 s</p>	Depend on model	<input type="radio"/>

Function code	Name	Description	Default	Modify																					
P00.13	Running direction	<p>0: Runs at the default direction, the VFD runs in the forward direction. FWD/REV indicator is off.</p> <p>1: Runs at the opposite direction, the VFD runs in the reverse direction. FWD/REV indicator is on.</p> <p>Modify the function code to shift the rotation direction of the motor. This effect equals to the shifting the rotation direction by adjusting either two of the motor lines (U, V and W). The motor rotation direction can be changed by QUICK/JOG on the keypad. Refer to parameter P07.02.</p> <p>Note: When the function parameter comes back to the default value, the motor's running direction will come back to the factory default state, too. In some cases it should be used with caution after commissioning if the change of rotation direction is disabled.</p> <p>2: Forbid to run in reverse direction: It can be used in some special cases if the reverse running is disabled.</p>	0	<input type="radio"/>																					
P00.14	Carrier frequency	<table border="1"> <thead> <tr> <th>Carrier frequency</th> <th>Electro magnetic noise</th> <th>Noise and leakage current</th> <th>Heating eliminating</th> </tr> </thead> <tbody> <tr> <td>1kHz</td> <td rowspan="2">↑ High</td> <td rowspan="2">↑ Low</td> <td rowspan="2">↑ Low</td> </tr> <tr> <td>10kHz</td> </tr> <tr> <td>15kHz</td> <td>↓ Low</td> <td>↓ High</td> <td>↓ High</td> </tr> </tbody> </table> <p>The relationship table of the motor type and carrier frequency:</p> <table border="1"> <thead> <tr> <th>Motor type</th> <th>Factory setting of carrier frequency</th> </tr> </thead> <tbody> <tr> <td>0.4–11kW</td> <td>8 kHz</td> </tr> <tr> <td>15–55kW</td> <td>4 kHz</td> </tr> <tr> <td>15–110kW</td> <td>4 kHz</td> </tr> </tbody> </table>	Carrier frequency	Electro magnetic noise	Noise and leakage current	Heating eliminating	1kHz	↑ High	↑ Low	↑ Low	10kHz	15kHz	↓ Low	↓ High	↓ High	Motor type	Factory setting of carrier frequency	0.4–11kW	8 kHz	15–55kW	4 kHz	15–110kW	4 kHz	Depend on model	<input type="radio"/>
Carrier frequency	Electro magnetic noise	Noise and leakage current	Heating eliminating																						
1kHz	↑ High	↑ Low	↑ Low																						
10kHz																									
15kHz	↓ Low	↓ High	↓ High																						
Motor type	Factory setting of carrier frequency																								
0.4–11kW	8 kHz																								
15–55kW	4 kHz																								
15–110kW	4 kHz																								

Function code	Name	Description	Default	Modify
		<p>The advantage of high carrier frequency: ideal current waveform, little current harmonic wave and motor noise.</p> <p>The disadvantage of high carrier frequency: increasing the switch loss, increasing VFD temperature and the impact to the output capacity. The VFD needs to derate on high carrier frequency. At the same time, the leakage and electrical magnetic interference will increase.</p> <p>Applying low carrier frequency is contrary to the above, too low carrier frequency will cause unstable running, torque decreasing and surge.</p> <p>The manufacturer has set a reasonable carrier frequency when the VFD is in factory. In general, users do not need to change the parameter.</p> <p>When the frequency used exceeds the default carrier frequency, the VFD needs to derate 10% for each additional 1k carrier frequency.</p> <p>Setting range: 1.0–15.0 kHz</p>		
P00.15	Motor parameter autotuning	<p>0: No operation</p> <p>1: Rotating autotuning Comprehensive motor parameter autotuning It is recommended to use rotating autotuning when high control accuracy is needed.</p> <p>2: Static autotuning 1 (autotune totally); It is suitable in the cases when the motor cannot de-couple from the load. The autotuning for the motor parameter will impact the control accuracy.</p> <p>3: Static autotuning 2 (autotune part parameters); when the current motor is motor 1, autotune P02.06, P02.07, and P02.08.</p>	0	⊙
P00.16	AVR function	<p>0: Invalid</p> <p>1: Valid during the whole procedure</p>	1	○

Function code	Name	Description	Default	Modify
	selection	The auto-adjusting function of the VFD can cancel the impact on the output voltage of the VFD because of the bus voltage fluctuation.		
P00.18	Function parameter restore	0-6 0: No operation 1: Restore the default value (excluding the motor parameters) 2: Clear fault records 3: Function code locking (lock all function codes) 4: Reserved 5: Restore the default value (factory test mode) 6: Restore the default value (including the motor parameters) Note: ✧ After the selected operation is performed, the function code is automatically restored to 0. Restoring default values may delete the user password. Exercise caution when using this function. ✧ Restoring default values (factory test mode) will restore the parameters to the corresponding standard version. Non-professionals shall exercise caution when using this function.	0	⊙

P01 group Start and stop control

Function code	Name	Description	Default	Modify
P01.00	Start mode	0: Direct start: start from the starting frequency P01.01 1: Start after DC braking: start the motor from the starting frequency after DC braking (set the parameter P01.03 and P01.04). It is suitable in the cases where reverse rotation may occur to the low inertia load during starting.	0	⊙

Function code	Name	Description	Default	Modify
		2: Speed tracking restart 1 3: Speed tracking restart 2 The direction and speed will be tracked automatically for the smoothing starting of rotating motors. It suits the application with reverse rotation when big load starting. Note: This function is only available for the VFDs \geq 4kW.		
P01.01	Starting frequency of direct start	The function code indicates the initial frequency during VFD start. See P01.02 (Starting frequency hold time) for detailed information. Setting range: 0.00–50.00Hz	0.50Hz	⊙
P01.02	Starting frequency hold time	Setting a proper starting frequency can increase the torque during VFD starting. During the hold time of the starting frequency, the output frequency of the VFD is the starting frequency. And then, the VFD runs from the starting frequency to the set frequency. If the set frequency is lower than the starting frequency, the VFD stops running and keeps in the stand-by state. The starting frequency is not limited in the lower limit frequency. <div style="text-align: center;"> <p>Setting range: 0.0–50.0s</p> </div>	0.0s	⊙
P01.03	Braking current before start	The VFD performs DC braking with the braking current before start and it speeds up after the DC braking time. If the DC braking time is set to 0, the DC braking is invalid.	0.0%	⊙
P01.04	Braking time	Stronger braking current indicates larger braking power. The DC braking current before start is the percentage of rated current of the	0.00s	⊙

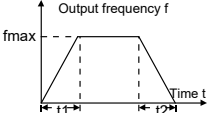
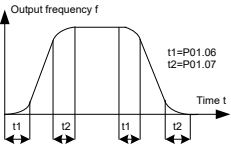
Function code	Name	Description	Default	Modify
	before start	VFD. Setting range of P01.03 : 0.0–100.0% (rated current peak of the VFD) Setting range of P01.04 : 0.00–50.00s		
P01.05	ACC and DEC mode	<p>The function code indicates that the changing mode of the frequency during start and running.</p> <p>0: Linear type. The output frequency increases or decreases linearly.</p>  <p>1: S curve. The output frequency increases or decreases according to the S curve</p>  <p>The S curve is generally applied to elevator, conveyors, and other application scenarios where smoother start or stop is required.</p>	0	⊙
P01.06	ACC time of the starting step of S curve	Setting range: 0.0–50.0s	0.1s	⊙
P01.07	DEC time of the ending step of S curve	Note: Valid when P01.05 is 1.	0.1s	⊙

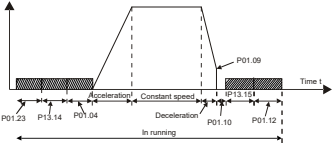
Function code	Name	Description	Default	Modify
P01.08	Stop mode	0: Decelerate to stop. After a stop command takes effect, the VFD lowers output frequency based on the DEC mode and the DEC time; after the frequency drop to 0Hz, the VFD stops. 1: Coast to stop. After a stop command takes effect, the VFD stops output immediately; and the load coasts to stop according to mechanical inertia.	0	<input type="radio"/>
P01.09	Starting frequency of DC braking for stop	Starting frequency of DC braking for stop: During the deceleration to stop, the VFD starts DC braking for stop when running frequency reaches the starting frequency determined by P1.09 .	0.00Hz	<input type="radio"/>
P01.10	Waiting time before DC braking	Waiting time before DC braking: The VFD blocks the output before starting DC braking. After this wait time, DC braking is started so as to prevent overcurrent caused by DC braking at high speed.	0.00s	<input type="radio"/>
P01.11	DC braking current for stop	DC braking current for stop: The value of P01.11 is the percentage of rated current of VFD. Stronger current indicates greater DC braking effect.	0.0%	<input type="radio"/>
P01.12	DC braking time for stop	DC braking time for stop: It indicates the hold time of DC braking. If the time is 0, DC braking is invalid, and the VFD coasts to stop.  Setting range of P01.09 : 0.00Hz– P00.03 (max. output frequency) Setting range of P01.10 : 0.00–50.00s Setting range of P01.11 : 0.0–100.0% (rated current peak of the VFD) Setting range of P01.12 : 0.00–50.00s	0.00s	<input type="radio"/>

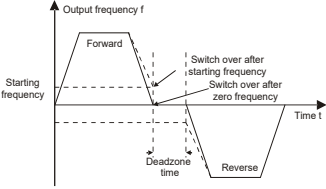
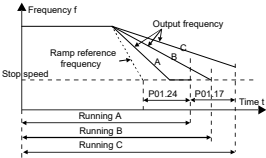
Function code	Name	Description	Default	Modify
P01.13	FWD/REV running deadzone time	<p>This function code indicates the transition time specified in P01.14 during FWD/REV rotation switching. See the following figure.</p>  <p>Setting range: 0.0–3600.0s</p>	0.0s	○
P01.14	FWD/REV running switching mode	<p>Set the switching threshold of the VFD:</p> <ul style="list-style-type: none"> 0: Switch at zero frequency 1: Switch at the starting frequency 2: Switch after the speed reaches the stop speed with a delay. 	1	◎
P01.15	Stop speed	0.00–100.00Hz	0.50Hz	◎
P01.16	Stop speed detection mode	<ul style="list-style-type: none"> 0: Set value of speed (the only detection mode valid in V/F mode) 1: Detection value of speed 	1	◎
P01.17	Feedback speed detection time	 <p>When P01.16=1, the actual output frequency of the VFD is less than or equal to P01.15 and is detected during the time set by P01.17, the VFD will stop; otherwise, the VFD stops in the time set by P01.24.</p> <p>Setting range: 0.00–100.00s (valid only when P01.16=1)</p>	0.50s	◎

Function code	Name	Description	Default	Modify
P01.18	Terminal-based running command protection at power-on	<p>When the channel of running commands is terminal control, the system detects the state of the running terminal during power-on.</p> <p>0: The terminal running command is invalid at power-on. Even the running command is considered as valid during power-on, the VFD does not run and it keeps the protection state until the running command is canceled and enabled again.</p> <p>1: The terminal running command is valid at power-on. If the running command is considered as valid during power-on, the VFD is started automatically after the initialization.</p> <p>Note: Exercise caution before using this function. Otherwise, serious result may follow.</p>	0	○
P01.19	Action selected when running frequency less than frequency lower limit (valid when frequency lower limit greater than 0)	<p>0x00–0x12</p> <p>Ones place: Action selection</p> <p>0: Run at the frequency lower limit</p> <p>1: Stop</p> <p>2: Sleep</p> <p>Tens place: Stop mode</p> <p>0: Coast to stop</p> <p>1: Decelerate to stop</p>	0x00	◎
P01.20	Wake-up-from-sleep delay	<p>This function code determines the wake-up-from-sleep delay time. When the running frequency of the VFD is lower than the lower limit, the VFD becomes standby.</p> <p>When the set frequency exceeds the lower limit one again and it lasts for the time set by P01.20, the VFD runs automatically.</p>	0.0s	○

Function code	Name	Description	Default	Modify
		<p>Setting range: 0.0–3600.0s (valid when the ones place of P01.19=2)</p>		
P01.21	Power-off restart selection	<p>The function code indicates whether the VFD automatically runs after power-on.</p> <p>0: Disable 1: Enable. If the restart condition is met, the VFD will run automatically after waiting for the time defined by P01.22.</p>	0	<input type="radio"/>
P01.22	Wait time for restart after power-off	<p>The function indicates the wait time before the automatic running of the VFD that is re-powered on.</p> <p>Setting range: 0.0–3600.0s (valid when P01.21=1)</p>	1.0s	<input type="radio"/>
P01.23	Start delay	<p>After a VFD running command is given, the VFD is in standby state and restarts with the delay defined by P01.23 to implement brake release.</p> <p>Setting range: 0.0–60.0s</p>	0.0s	<input type="radio"/>
P01.24	Delay of the stopping speed	<p>Setting range: 0.0–100.0s</p>	0.0s	<input type="radio"/>

Function code	Name	Description	Default	Modify
P01.25	0Hz output	Select the 0Hz output of the VFD. 0: Output without voltage 1: Output with voltage 2: Output at the DC braking current	0	<input type="radio"/>

P02 group Motor 1 parameters

Function code	Name	Description	Default	Modify
P02.01	Rated power of asynchronous motor	0.1–3000.0kW Parameters of the controlled asynchronous motor. To ensure the control performance, set P02.01–P02.05 correctly according to the information on the nameplate of the asynchronous motor.	Depend on model	<input type="radio"/>
P02.02	Rated frequency of asynchronous motor	0.01Hz– P00.03 The Goodrive20 series VFD provides the parameter autotuning function. Whether parameter autotuning can be performed properly depends on the settings of the motor nameplate parameters.	50.00Hz	<input type="radio"/>
P02.03	Rated speed of asynchronous motor	1–60000 rpm In addition, you need to configure a motor based on the standard motor configuration of the VFD. If the power of the motor is greatly different from that of the standard motor configuration, the control performance of the VFD degrades significantly.	Depend on model	<input type="radio"/>
P02.04	Rated voltage of asynchronous motor	0–1200V Note: Resetting the rated power of the motor (P02.01) can initialize the parameters of P02.02 to P02.10 .	Depend on model	<input type="radio"/>
P02.05	Rated current of asynchronous motor	0.8–6000.0A	Depend on model	<input type="radio"/>
P02.06	Stator resistor of asynchronous motor	0.001–65.535Ω After motor parameter autotuning is properly performed, the values of P02.06 to P02.10 are	Depend on model	<input type="radio"/>

Function code	Name	Description		Default	Modify
P02.07	Rotor resistor of asynchronous motor	0.001–65.535Ω	automatically updated. These parameters are the reference parameters for high-performance vector control, directly affecting the control performance. Note: Do not modify these parameters unless it is necessary.	Depend on model	<input type="radio"/>
P02.08	Leakage inductance of asynchronous motor	0.1–6553.5mH		Depend on model	<input type="radio"/>
P02.09	Mutual inductance of asynchronous motor	0.1–6553.5mH		Depend on model	<input type="radio"/>
P02.10	Non-load current of asynchronous motor	0.1–6553.5A		Depend on model	<input type="radio"/>
P02.11	Magnetic saturation coefficient 1 of iron core of AM1	0.0–100.0%		80.0%	<input checked="" type="radio"/>
P02.12	Magnetic saturation coefficient 2 of iron core of AM1	0.0–100.0%		68.0%	<input checked="" type="radio"/>
P02.13	Magnetic saturation coefficient 3 of iron core of AM1	0.0–100.0%		57.0%	<input checked="" type="radio"/>

Function code	Name	Description	Default	Modify
P02.14	Magnetic saturation coefficient 4 of iron core of AM1	0.0–100.0%	40.0%	⊙
P02.26	Motor overload protection selection	0: No protection 1: Common motor protection (with low speed compensation). As the cooling effect of a common motor is degraded at low speed running, the corresponding electronic thermal protection value needs to be adjusted properly. The low speed compensation indicates lowering the overload protection threshold of the motor whose running frequency is lower than 30Hz. 2: Variable-frequency motor compensation (without low speed compensation). Because the heat dissipation function for a variable-frequency motor is not impacted by the rotation speed, it is not necessary to adjust the protection value at low speed running.	2	⊙
P02.27	Motor overload protection coefficient	Motor overload multiples $M = I_{out}/(I_n \cdot K)$ I_n is rated motor current, I_{out} is VFD output current, and K is motor overload protection coefficient. A smaller value of K indicates a bigger value of M . When $M=116\%$, protection is performed after motor overload lasts for 1 hour; when $M=150\%$, protection is performed after motor overload lasts for 12 minutes; when $M=180\%$, protection is performed after motor overload lasts for 5 minutes; when $M=200\%$, protection is performed after motor overload lasts for 60 seconds; and when $M \geq 400\%$, protection is performed immediately.	100.0%	○

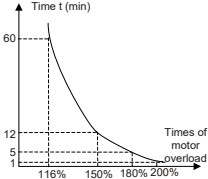
Function code	Name	Description	Default	Modify
		 <p>Setting range: 20.0%–120.0%</p>		
P02.28	Power display calibration coefficient of motor 1	The function code can be used to adjust the power display value of motor 1. However, it does not affect the control performance of the VFD. Setting range: 0.00–3.00	1.00	<input type="radio"/>

P03 group Vector control

Function code	Name	Description	Default	Modify
P03.00	Speed loop proportional gain1	The speed loop dynamic response characteristics of vector control can be adjusted by setting the proportional coefficient and integral time of speed regulator. Increase proportional gain or decrease integral time can accelerate dynamic response of speed loop, however, if the proportional gain is too large or integral time is too small, system oscillation and overshoot may occur; if proportional gain is too small, stable oscillation or speed offset may occur.	20.0	<input type="radio"/>
P03.01	Speed loop integral time1		0.200s	<input type="radio"/>
P03.02	Low-point frequency for switching		5.00Hz	<input type="radio"/>
P03.03	Speed loop proportional gain 2		20.0	<input type="radio"/>
P03.04	Speed loop integral time 2		0.200s	<input type="radio"/>
P03.05	High-point frequency for switching	The parameters P03.00–P03.05 are applicable only to vector control mode. Below the switching frequency 1 (P03.02), the speed loop PI parameters are: P03.00 and P03.01 . Above the switching frequency 2 (P03.05), the speed loop PI parameters are: P03.03	10.00Hz	<input type="radio"/>

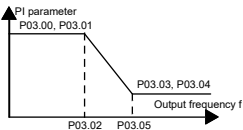
Function code	Name	Description	Default	Modify
		<p>and P03.04. PI parameters are obtained according to the linear change of two groups of parameters. See the following figure.</p>  <p>PI parameters have a close relationship with the inertia of the system. Adjust PI parameters depending on different loads to meet various demands.</p> <p>Setting range of P03.00 and P03.03: 0–200.0</p> <p>Setting range of P03.01 and P03.04: 0.000–10.000s</p> <p>Setting range of P03.02:0.00Hz–P03.05 Setting range of P03.05:P03.02–P00.03 (max. output frequency)</p>		
P03.06	Speed loop output filter	0–8 (corresponding to 0–2 ⁸ /10ms)	0	<input type="radio"/>
P03.07	Electromotion slip compensation coefficient of vector control	Slip compensation coefficient is used to adjust the slip frequency of the vector control and improve the speed control accuracy of the system. Adjusting the parameter properly can control the speed steady-state error.	100%	<input type="radio"/>
P03.08	Brake slip compensation coefficient of vector control	Setting range: 50%–200%	100%	<input type="radio"/>
P03.09	Current loop percentage coefficient P	<p>Note:</p> <ul style="list-style-type: none"> ✧ The two function codes impact the dynamic response speed and control accuracy of the system. Generally, you do not need to modify the two function codes. ✧ The parameters P03.09 and P03.10 	1000	<input type="radio"/>
P03.10	Current loop integral coefficient I		1000	<input type="radio"/>

Function code	Name	Description	Default	Modify
		are applicable only to SVC 0 (P00.00=0). Setting range: 0–65535		
P03.11	Torque setting method	The function code is used to enable the torque control mode, and set the torque setting method. 0: Torque control is invalid 1: Keypad setting torque (P03.12) 2: AI1 3: AI2 4: AI3 5: Pulse frequency HDI 6: Multi-step torque 7: Modbus communication 8–10: Reserved Note: Setting methods 2–7, 100% corresponds to 3 times of the rated motor current.	0	<input type="radio"/>
P03.12	Torque set through keypad	Setting range: -300.0%–300.0% (of the rated motor current)	50.0%	<input type="radio"/>
P03.13	Torque reference filter time	0.000–10.000s	0.100s	<input type="radio"/>
P03.14	Setting source of forward rotation upper-limit frequency in torque control	0: Keypad (P03.16 sets the value when P03.14=1; P03.17 sets the value when P03.15=1) 1: AI1 2: AI2 3: AI3	0	<input type="radio"/>
P03.15	Setting source of reverse rotation upper-limit frequency in torque control	4: Pulse frequency HDI 5: Multi-step setting 6: Modbus communication 7–9: Reserved Note: Setting methods 1–9, 100% corresponds to the maximum frequency.	0	<input type="radio"/>
P03.16	Forward rotation upper-limit	This function codes are used to set the frequency upper limits. 100% corresponds to the max. frequency.	50.00Hz	<input type="radio"/>

Function code	Name	Description	Default	Modify
	frequency keypad set through keypad in torque control	P03.16 sets the value when P03.14 =1; P03.17 sets the value when P03.15 =1. Setting range: 0.00Hz– P00.03 (max. output frequency)		
P03.17	Reverse rotation upper-limit frequency set through keypad in torque control		50.00Hz	<input type="radio"/>
P03.18	Setting source of electromotive torque upper limit	This function codes are used to select the setting sources of electromotive and braking torque upper limits. 0: Keypad setting upper-limit frequency (P03.20 sets P03.18 and P03.21 sets P03.19)	0	<input type="radio"/>
P03.19	Setting source of braking torque upper limit	1: AI1 2: AI2 3: AI3 4: Pulse frequency HDI 5: Modbus communication 6–8: Reserved Note: Setting methods 1–8, 100% corresponds to three times of the motor current.	0	<input type="radio"/>
P03.20	Electromotive torque upper limit set through keypad	The function codes are used to set the torque limits. Setting range: 0.0–300.0% (of the rated motor current)	180.0%	<input type="radio"/>
P03.21	Braking torque upper limit set through keypad		180.0%	<input type="radio"/>
P03.22	Weakening coefficient in constant power zone	Used when the AM is in flux-weakening control. The function codes P03.22 and P03.23 are valid at constant power. The motor enters the flux-weakening state when the motor runs above the rated speed.	0.3	<input type="radio"/>
P03.23	Lowest weakening point in constant power zone	Change the flux-weakening curve by modifying the flux-weakening control	20%	<input type="radio"/>

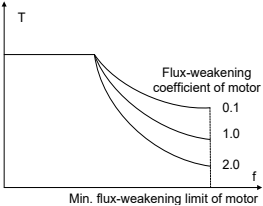
Function code	Name	Description	Default	Modify
		<p>coefficient. The larger the coefficient, the steeper the curve, the smaller the coefficient, the smoother the curve.</p>  <p>Setting range of P03.22: 0.1–2.0 Setting range of P03.23: 10%–100%</p>		
P03.24	Max. voltage limit	<p>P03.24 set the max. output voltage of the VFD. Set the value according to onsite conditions Setting range: 0.0–120.0%</p>	100.0%	<input checked="" type="radio"/>
P03.25	Pre-exciting time	<p>Pre-exciting is performed for the motor when the VFD starts up. A magnetic field is built up inside the motor to improve the torque performance during the start process. The setting time: 0.000–10.000s</p>	0.300s	<input type="radio"/>
P03.26	Flux-weakening proportional gain	0–8000	1200	<input type="radio"/>
P03.27	Speed display selection in vector control	0: Display at the actual value 1: Display at the setting value	0	<input type="radio"/>
P03.28	Static friction compensation coefficient	0.0–100.0%	0.0%	<input type="radio"/>
P03.29	Dynamical friction compensation coefficient	0.0–100.0%	0.0%	<input type="radio"/>

P04 group SVPWM control

Function code	Name	Description	Default	Modify
P04.00	V/F curve setting of motor 1	<p>This group of function code defines the V/F curve of motor 1 to meet the needs of different loads.</p> <p>0: Straight-line V/F curve; applicable to constant torque loads 1: Multi-point V/F curve 2: Torque-down V/F curve (power of 1.3) 3: Torque-down V/F curve (power of 1.7) 4: Torque-down V/F curve (power of 2.0)</p> <p>Curves 2–4 are applicable to the torque loads such as fans and water pumps. You can adjust according to the characteristics of the loads to achieve best performance.</p> <p>5: Customized V/F (V/F separation); in this mode, V can be separated from f and f can be adjusted through the frequency setting channel set by P00.06 or the voltage setting channel set by P04.27 to change the characteristics of the curve.</p> <p>Note: In the following figure, V_b is the motor rated voltage and f_b is the motor rated frequency.</p>	0	⊙
P04.01	Torque boost of motor 1	In order to compensate for low-frequency torque characteristics, you can make some boost compensation for the output voltage.	0.0%	○
P04.02	Torque boost cut-off of motor 1	P04.01 is relative to the maximum output voltage V_b . P04.02 defines the percentage of cut-off frequency of manual torque boost to the rated motor frequency f_b . Torque boost can improve the low-frequency torque characteristics of SVPWM.	20.0%	○

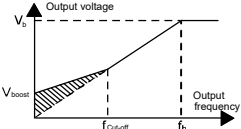
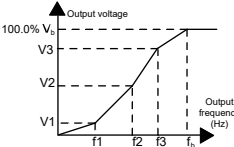
Function code	Name	Description	Default	Modify
		<p>You need to select torque boost based on the load. For example, larger load requires larger torque boost, however, if the torque boost is too large, the motor will run at over-excitation, which may cause increased output current and motor overheating, thus decreasing the efficiency.</p> <p>When torque boost is set to 0.0%, the VFD is automatic torque boost.</p> <p>Torque boost cut-off threshold: Below this frequency threshold, the torque boost is valid, exceeding this threshold will invalidate torque boost.</p>  <p>Setting range of P04.01: 0.0%: (automatic) 0.1%–10.0%</p> <p>Setting range of P04.02: 0.0%–50.0%</p>		
P04.03	V/F frequency point 1 of motor 1	When P04.00 =1 (multi-dot V/F curve), you can set the V//F curve through P04.03–P04.08.	0.00Hz	<input type="radio"/>
P04.04	V/F voltage point 1 of motor 1	 <p>The V/F curve is generally set according to the load characteristics of the motor.</p> <p>Note: $V1 < V2 < V3$, $f1 < f2 < f3$. Too high voltage for low frequency will cause motor overheat or damage and cause VFD overcurrent stall or overcurrent protection.</p>	0.0%	<input type="radio"/>
P04.05	V/F frequency point 2 of motor 1		0.00Hz	<input type="radio"/>
P04.06	V/F voltage point 2 of motor 1		0.0%	<input type="radio"/>

Function code	Name	Description	Default	Modify
P04.07	V/F frequency point 3 of motor 1	Setting range of P04.03 : 0.00Hz–P04.05 Setting range of P04.04 , P04.06 and P04.08 : 0.0%–110.0% (of the rated motor voltage) Setting range of P04.05 : P04.03 – P04.07	0.00Hz	<input type="radio"/>
P04.08	V/F voltage point 3 of motor 1	Setting range of P04.07 : P04.05 – P02.02 (of the rated motor frequency)	0.0%	<input type="radio"/>
P04.09	V/F slip compensation gain of motor 1	This function code is used to compensate for the motor rotating speed change caused by load change in SVPWM control mode, and thus improve the mechanical characteristics of the motor. You need to calculate the rated slip frequency of the motor as follows: $\Delta f = f_b - n \cdot p / 60$ Of which, f_b is the rated frequency of the motor, corresponding to function code is P02.02 . n is the rated rotating speed of the motor, corresponding to function code P02.03 . p is the number of pole pairs of the motor. 100.0% corresponds to the rated slip frequency Δf of the motor. Setting range: 0.0–200.0%	100.0%	<input type="radio"/>
P04.10	Low frequency vibration control factor of motor 1	In the SVPWM control mode, the motor, especially the large-power motor, may experience current oscillation at certain frequencies, which may cause unstable motor running, or even VFD overcurrent. You can adjust the two function codes properly to eliminate such phenomenon.	10	<input type="radio"/>
P04.11	High frequency vibration control factor of motor 1	Setting range of P04.10 and P04.11 : 0–100 Setting range of P04.12 : 0.00Hz– P00.03 (max. output frequency)	10	<input type="radio"/>
P04.12	Vibration control threshold		30.00Hz	<input type="radio"/>

Function code	Name	Description	Default	Modify
	of motor 1			
P04.26	Energy-saving run	0: Disable 1: Automatic energy-saving operation In light-load state, the motor can adjust the output voltage automatically to achieve energy saving.	0	☉
P04.27	Voltage Setting channel	Select the output voltage setting channel at V/F curve separation. 0: Keypad (The output voltage is determined by P04.28) 1: AI1 2: AI2 3: AI3 4: HDI 5: Multi-step speed 6: PID 7: Modbus communication 8–10: Reversed Note: Setting methods 1–7, 100% corresponds to the rated motor voltage.	0	○
P04.28	Voltage set through keypad	The function code is the voltage digital setting when "keypad" is selected as the voltage setting channel. Setting range: 0.0%–100.0%	100.0%	○
P04.29	Voltage increase time	Voltage increase time indicates the time needed for the VFD to accelerate from min. output voltage to the max. output voltage.	5.0s	○
P04.30	Voltage decrease time	Voltage decrease time indicates the time needed for the VFD to decelerate from max. output voltage to the min. output voltage. Setting range: 0.0–3600.0s	5.0s	○
P04.31	Max. output voltage	The function codes are used to set the upper and lower limits of output voltage.	100.0%	☉
P04.32	Min. output voltage		0.0%	☉

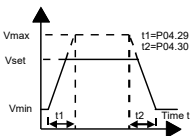
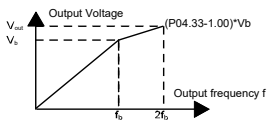
Function code	Name	Description	Default	Modify
		 <p>Setting range of P04.31: P04.32–100.0% (of the rated motor voltage) Setting range of P04.32: 0.0%–P04.31 (of the rated motor voltage)</p>		
P04.33	Weakening coefficient in constant power zone	<p>The function code is used to adjust the output voltage of the VFD in SVPWM mode during flux-weakening.</p> <p>Note: This parameter is invalid in the constant torque mode.</p>  <p>Setting range of P04.33: 1.00–1.30</p>	1.00	○

P05 group Input terminals

Function code	Name	Description	Default	Modify
P05.00	HDI input type	0: HDI is high-speed pulse input. See P05.50–P05.54 . 1: HDI is digital input	0	⊙
P05.01	S1 terminals function selection	Note: S1–S4, HDI are the upper terminals on the control board and P05.12 can be used to set the functions of S5–S8. 0: No function	1	⊙
P05.02	S2 terminals function selection	1: Forward running 2: Reverse running 3: 3-wire running control	4	⊙
P05.03	S3 terminals	4: Forward jogging 5: Reverse jogging	7	⊙

Function code	Name	Description	Default	Modify
	function selection	6: Coast to stop 7: Fault reset		
P05.04	S4 terminals function selection	8: Running pause 9: External fault input 10: Frequency increase (UP) 11: Frequency decrease (DOWN)	0	⊙
P05.05	S5 terminals function selection	12: Clear frequency increase/decrease setting 13: Switch-over between setup A and setup B 14: Switch-over between combination setting and setup A	0	⊙
P05.06	S6 terminals function selection	15: Switch-over between combination setting and setup B 16: Multi-step speed terminal 1	0	⊙
P05.07	S7 terminals function selection	17: Multi-step speed terminal 2 18: Multi-step speed terminal 3 19: Multi-step speed terminal 4 20: Multi-step speed pause	0	⊙
P05.08	S8 terminals function selection	21: ACC/DEC time selection 1 22: ACC/DEC time selection 2 23: Simple PLC stop reset 24: Simple PLC pause	0	⊙
P05.09	HDI terminals function selection	25: PID control pause 26: Wobbling frequency pause (stop at the current frequency) 27: Wobbling frequency reset (return to the center frequency) 28: Counter reset 29: Torque control disabled 30: ACC/DEC disabled 31: Counter trigger 32: Reserved 33: Clear frequency increase/decrease setting temporarily 34: DC brake 35: Reserved 36: Command switches to keypad 37: Command switches to the terminals 38: Command switches to communication 39: Pre-exciting command	0	⊙

Function code	Name	Description	Default	Modify																				
		40: Zero out power consumption quantity 41: Maintain the power consumption quantity 42: Emergency stop 43–60: Reserved 61: PID polarity switch-over 62–63: Reserved When the terminal acts as ACC/DEC time selection, you need to select four groups of ACC/DEC time through state combinations of these two terminals.																						
		<table border="1"> <thead> <tr> <th>Terminal1</th> <th>Terminal2</th> <th>ACC/DEC time setting</th> <th>Parameters</th> </tr> </thead> <tbody> <tr> <td>OFF</td> <td>OFF</td> <td>ACC/DEC time 1</td> <td>P00.11/P00.12</td> </tr> <tr> <td>ON</td> <td>OFF</td> <td>ACC/DEC time 2</td> <td>P08.00/P08.01</td> </tr> <tr> <td>OFF</td> <td>ON</td> <td>ACC/DEC time 3</td> <td>P08.02/P08.03</td> </tr> <tr> <td>ON</td> <td>ON</td> <td>ACC/DEC time 4</td> <td>P08.04/P08.05</td> </tr> </tbody> </table> Setting range of P05.01–P05.09 : 0–63	Terminal1	Terminal2	ACC/DEC time setting	Parameters	OFF	OFF	ACC/DEC time 1	P00.11/P00.12	ON	OFF	ACC/DEC time 2	P08.00/P08.01	OFF	ON	ACC/DEC time 3	P08.02/P08.03	ON	ON	ACC/DEC time 4	P08.04/P08.05		
Terminal1	Terminal2	ACC/DEC time setting	Parameters																					
OFF	OFF	ACC/DEC time 1	P00.11/P00.12																					
ON	OFF	ACC/DEC time 2	P08.00/P08.01																					
OFF	ON	ACC/DEC time 3	P08.02/P08.03																					
ON	ON	ACC/DEC time 4	P08.04/P08.05																					
P05.10	Input terminal polarity	The function code is used to set the polarity of input terminals. When a bit is 0, the input terminal is positive. When a bit is 1, the input terminal is negative. <table border="1"> <tbody> <tr> <td>BIT8</td> <td>BIT7</td> <td>BIT6</td> <td>BIT5</td> <td>BIT4</td> </tr> <tr> <td>HDI</td> <td>S8</td> <td>S7</td> <td>S6</td> <td>S5</td> </tr> <tr> <td>BIT3</td> <td>BIT2</td> <td>BIT1</td> <td>BIT0</td> <td></td> </tr> <tr> <td>S4</td> <td>S3</td> <td>S2</td> <td>S1</td> <td></td> </tr> </tbody> </table> Setting range: 0x000–0x1FF	BIT8	BIT7	BIT6	BIT5	BIT4	HDI	S8	S7	S6	S5	BIT3	BIT2	BIT1	BIT0		S4	S3	S2	S1		0x000	○
BIT8	BIT7	BIT6	BIT5	BIT4																				
HDI	S8	S7	S6	S5																				
BIT3	BIT2	BIT1	BIT0																					
S4	S3	S2	S1																					
P05.11	Digital input filter time	The function code is used to set the filter time for S1–S8 and HDI. In strong interference cases, increase the value to avoid mal-operation. 0.000–1.000s	0.010s	○																				
P05.12	Virtual terminal	0x000–0x1FF (0: Disable, 1: Enable) BIT0: S1 virtual terminal	0x000	◎																				

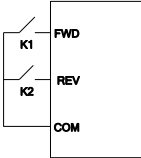
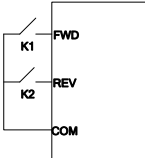
Function code	Name	Description	Default	Modify																														
	setting	BIT1: S2 virtual terminal BIT2: S3 virtual terminal BIT3: S4 virtual terminal BIT4: S5 virtual terminal BIT5: S6 virtual terminal BIT6: S7 virtual terminal BIT7: S8 virtual terminal BIT8: HDI virtual terminal Note: After a virtual terminal is enabled, you can change the state of the terminal only in communication mode with the communication address is 0x200A.																																
P05.13	Terminal control mode	<p>The function code is used to set the mode of terminal control.</p> <p>0: 2-wire control 1, the enabling consistent with the direction. This mode is widely used. The defined FWD/REV terminal command determines the motor rotation direction.</p>  <table border="1" data-bbox="539 729 702 933"> <thead> <tr> <th>FWD</th> <th>REV</th> <th>Running command</th> </tr> </thead> <tbody> <tr> <td>OFF</td> <td>OFF</td> <td>Stopping</td> </tr> <tr> <td>ON</td> <td>OFF</td> <td>Forward running</td> </tr> <tr> <td>OFF</td> <td>ON</td> <td>Reverse running</td> </tr> <tr> <td>ON</td> <td>ON</td> <td>Hold on</td> </tr> </tbody> </table> <p>1: 2-wire control 2, the enabling separated from the direction. In this mode, FWD is the enabling terminal. The direction depends on the defined REV state.</p>  <table border="1" data-bbox="539 1067 702 1271"> <thead> <tr> <th>FWD</th> <th>REV</th> <th>Running command</th> </tr> </thead> <tbody> <tr> <td>OFF</td> <td>OFF</td> <td>Stopping</td> </tr> <tr> <td>ON</td> <td>OFF</td> <td>Forward running</td> </tr> <tr> <td>OFF</td> <td>ON</td> <td>Stopping</td> </tr> <tr> <td>ON</td> <td>ON</td> <td>Reverse running</td> </tr> </tbody> </table> <p>2: 3-wire control 1; This mode defines Sin as the enabling terminal, and the running command is generated by FWD, while the</p>	FWD	REV	Running command	OFF	OFF	Stopping	ON	OFF	Forward running	OFF	ON	Reverse running	ON	ON	Hold on	FWD	REV	Running command	OFF	OFF	Stopping	ON	OFF	Forward running	OFF	ON	Stopping	ON	ON	Reverse running	0	©
FWD	REV	Running command																																
OFF	OFF	Stopping																																
ON	OFF	Forward running																																
OFF	ON	Reverse running																																
ON	ON	Hold on																																
FWD	REV	Running command																																
OFF	OFF	Stopping																																
ON	OFF	Forward running																																
OFF	ON	Stopping																																
ON	ON	Reverse running																																

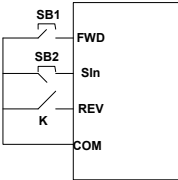
Function code	Name	Description	Default	Modify																						
		<p>direction is controlled by REV. During running, the Sin terminal needs to be closed, and terminal FWD generates a rising edge signal, then the VFD starts to run in the direction set by the state of terminal REV; the VFD needs to be stopped by disconnecting terminal Sin.</p>  <p>During running, the direction control is as follows:</p> <table border="1" data-bbox="298 677 743 939"> <thead> <tr> <th>Sin</th> <th>REV</th> <th>Previous direction</th> <th>Present direction</th> </tr> </thead> <tbody> <tr> <td rowspan="2">ON</td> <td rowspan="2">OFF→ON</td> <td>Forward</td> <td>Reverse</td> </tr> <tr> <td>Reverse</td> <td>Forward</td> </tr> <tr> <td rowspan="2">ON</td> <td rowspan="2">ON→OFF</td> <td>Reverse</td> <td>Forward</td> </tr> <tr> <td>Forward</td> <td>Reverse</td> </tr> <tr> <td>ON→OFF</td> <td>ON</td> <td colspan="2" rowspan="2">Decelerate to stop</td> </tr> <tr> <td>OFF</td> <td>OFF</td> </tr> </tbody> </table> <p>SIn: 3-wire control, FWD: Forward running, REV: Reverse running</p> <p>3: 3-wire control 2; This mode defines Sin as the enabling terminal, and the running command is generated by FWD or REV, but the direction is controlled by both FWD and REV. During running, the Sin terminal needs to be closed, and terminal FWD or REV generates a rising edge signal to control the running and direction of VFD; the VFD needs to be stopped by disconnecting terminal Sin.</p>	Sin	REV	Previous direction	Present direction	ON	OFF→ON	Forward	Reverse	Reverse	Forward	ON	ON→OFF	Reverse	Forward	Forward	Reverse	ON→OFF	ON	Decelerate to stop		OFF	OFF		
Sin	REV	Previous direction	Present direction																							
ON	OFF→ON	Forward	Reverse																							
		Reverse	Forward																							
ON	ON→OFF	Reverse	Forward																							
		Forward	Reverse																							
ON→OFF	ON	Decelerate to stop																								
OFF	OFF																									

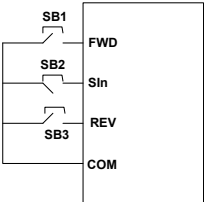
Function code	Name	Description	Default	Modify																								
		 <table border="1" data-bbox="298 429 743 662"> <thead> <tr> <th>SIn</th> <th>FWD</th> <th>REV</th> <th>Direction</th> </tr> </thead> <tbody> <tr> <td rowspan="2">ON</td> <td rowspan="2">OFF→ON</td> <td>ON</td> <td>Forward</td> </tr> <tr> <td>OFF</td> <td>Reverse</td> </tr> <tr> <td rowspan="2">ON</td> <td>ON</td> <td>OFF→</td> <td>Forward</td> </tr> <tr> <td>OFF</td> <td>ON</td> <td>Reverse</td> </tr> <tr> <td>ON→</td> <td>/</td> <td>/</td> <td rowspan="2">Decelerate to stop</td> </tr> <tr> <td>OFF</td> <td>/</td> <td>/</td> </tr> </tbody> </table> <p>SIn: 3-wire control, FWD: Forward running, REV: Reverse running</p> <p>Note: For 2-wire controlled running mode, when the FWD/REV terminal is valid, if the VFD stops due to a stop command given by another source, the VFD does not run again after the stop command disappears even if the control terminal FWD/REV is still valid. To make the VFD run, you need to trigger FWD/REV again, for example, PLC single-cycle stop, fixed-length stop, and valid STOP/RST stop during terminal control. (See P07.04).</p>	SIn	FWD	REV	Direction	ON	OFF→ON	ON	Forward	OFF	Reverse	ON	ON	OFF→	Forward	OFF	ON	Reverse	ON→	/	/	Decelerate to stop	OFF	/	/		
SIn	FWD	REV	Direction																									
ON	OFF→ON	ON	Forward																									
		OFF	Reverse																									
ON	ON	OFF→	Forward																									
	OFF	ON	Reverse																									
ON→	/	/	Decelerate to stop																									
OFF	/	/																										
P05.14	S1 switch-on delay	The function code defines the delay time corresponding to the electrical level change when the programmable input terminals switch on to switch off.	0.000s	○																								
P05.15	S1 switch-off delay		0.000s	○																								
P05.16	S2 switch-on delay		0.000s	○																								

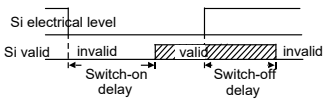
Function code	Name	Description	Default	Modify
P05.17	S2 switch-off delay	 <p>Setting range: 0.000–50.000s</p>	0.000s	○
P05.18	S3 switch-on delay		0.000s	○
P05.19	S3 switch-off delay		0.000s	○
P05.20	S4 switch-on delay		0.000s	○
P05.21	S4 switch-off delay		0.000s	○
P05.22	S5 switch-on delay		0.000s	
P05.23	S5 switch-off delay		0.000s	
P05.24	S6 switch-on delay		0.000s	
P05.25	S6 switch-off delay		0.000s	
P05.26	S7 switch-on delay		0.000s	
P05.27	S7 switch-off delay		0.000s	
P05.28	S8 switch-on delay		0.000s	
P05.29	S8 switch-off delay		0.000s	

Function code	Name	Description	Default	Modify
P05.30	HDI switch-on delay	<p>AI1 is set by the analog potentiometer, AI2 is set by control terminal AI2 and AI3 is set by control terminal AI3.</p> <p>The function code defines the relationship between the analog input voltage and its corresponding set value. If the analog input voltage beyond the set minimum or maximum input value, the VFD will count at the minimum or maximum one.</p> <p>When the analog input is the current input, the corresponding voltage of 0–20 mA is 0–10V. In different cases, the corresponding rated value of 100.0% is different. See the application for detailed information.</p> <p>Input filter time: this parameter is used to adjust the sensitivity of the analog input. Increasing the value properly can enhance the anti-interference of the analog, but weaken the sensitivity of the analog input</p> <p>Note: AI1 supports 0–10V input and AI2 supports 0–10V or 0–20 mA input, when AI2 selects 0–20 mA input, the corresponding voltage of 20 mA is 10V. AI3 can support the output of -10V~+10V.</p> <p>The following figure illustrates different applications:</p>	0.000s	<input type="radio"/>
P05.31	HDI switch-off delay		0.000s	<input type="radio"/>
P05.32	Lower limit of AI1		0.00V	<input type="radio"/>
P05.33	Corresponding setting of the lower limit of AI1		0.0%	<input type="radio"/>
P05.34	Upper limit of AI1		10.00V	<input type="radio"/>
P05.35	Corresponding setting of the upper limit of AI1		100.0%	<input type="radio"/>
P05.36	AI1 input filter time		0.100s	<input type="radio"/>
P05.37	Lower limit of AI2		0.00V	<input type="radio"/>
P05.38	Corresponding setting of the lower limit of AI2		0.0%	<input type="radio"/>
P05.39	Upper limit of AI2		10.00V	<input type="radio"/>
P05.40	Corresponding setting of the upper limit of AI2		100.0%	<input type="radio"/>
P05.41	AI2 input filter time	0.100s	<input type="radio"/>	

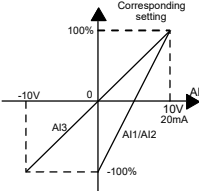
Function code	Name	Description	Default	Modify	
P05.42	Lower limit of AI3		-10.00V	<input type="radio"/>	
P05.43	Corresponding setting of the lower limit of AI3		-100.0%	<input type="radio"/>	
P05.44	Middle value of AI3		Setting range of P05.32 : 0.00V– P05.34 Setting range of P05.33 and P05.35 : -100.0%–100.0%	0.00V	<input type="radio"/>
P05.45	Corresponding middle setting of AI3		Setting range of P05.34 : P05.32 –10.00V Setting range of P05.36 : 0.000s–10.000s Setting range of P05.37 : 0.00V– P05.39 Setting range of P05.38 and P05.40 : -100.0%–100.0%	0.0%	<input type="radio"/>
P05.46	Upper limit of AI3	Setting range of P05.39 : P05.37 –10.00V Setting range of P05.41 : 0.000s–10.000s	10.00V	<input type="radio"/>	
P05.47	Corresponding setting of the upper limit of AI3	Setting range of P05.42 : -10.00V– P05.44 Setting range of P05.43 , P05.45 , and P05.47 : -100.0%–+100.0%	100.0%	<input type="radio"/>	
P05.48	AI3 input filter time	Setting range of P05.44 : P05.42 – P05.46 Setting range of P05.46 : P05.44 –10.00V Setting range of P05.48 : 0.000s–10.000s	0.100s	<input type="radio"/>	
P05.50	Lower limit frequency of HDI	0.000 kHz– P05.52	0.000 kHz	<input type="radio"/>	
P05.51	Corresponding setting of HDI low frequency setting	-100.0%–100.0%	0.0%	<input type="radio"/>	
P05.52	Upper limit frequency of HDI	P05.50 –50.000 kHz	50.000 kHz	<input type="radio"/>	

Function code	Name	Description	Default	Modify
P05.53	Corresponding setting of upper limit frequency of HDI	-100.0%–100.0%	100.0%	<input type="radio"/>
P05.54	HDI frequency input filter time	0.000s–10.000s	0.100s	<input type="radio"/>

P06 group Output terminals

Function code	Name	Description	Default	Modify
P06.01	Y1 output type	0: Invalid 1: In operation	0	<input type="radio"/>
P06.03	RO1 output	2: Forward rotation operation 3: Reverse rotation operation	1	<input type="radio"/>
P06.04	RO2 output	4: Jogging operation 5: The VFD fault 6: Frequency degree test FDT1 7: Frequency degree test FDT2 8: Frequency arrival 9: In zero-speed operation (output in running state) 10: Upper limit frequency arrival 11: Lower limit frequency arrival 12: Ready for operation 13: Pre-magnetizing 14: Overload pre-alarm 15: Underload pre-alarm 16: Completion of simple PLC step 17: Completion of simple PLC cycle 18: Setting count value arrival 19: Defined count value arrival 20: External fault valid 21: Zero-speed output (output in both running and stopping states) 22: Running time arrival	5	<input type="radio"/>

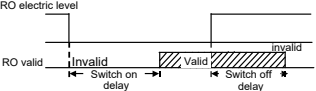
Function code	Name	Description	Default	Modify								
		23: Modbus communication virtual terminals output 24–25: Reserved 26: Establishment of DC bus voltage 27–30: Reserved										
P06.05	Output terminal polarity selection	The function code is used to set the polarity of output terminals. When the bit is set to 0, the terminal is positive. When the bit is set to 1, the terminal is negative. <table border="1" style="margin: 10px auto;"> <tr> <td>BIT3</td> <td>BIT2</td> <td>BIT1</td> <td>BIT0</td> </tr> <tr> <td>RO2</td> <td>RO1</td> <td>Reserved</td> <td>Y1</td> </tr> </table> Setting range: 0x00–0x0F	BIT3	BIT2	BIT1	BIT0	RO2	RO1	Reserved	Y1	0x00	○
BIT3	BIT2	BIT1	BIT0									
RO2	RO1	Reserved	Y1									
P06.06	Y1 switch-on delay	Setting range: 0.000–50.000s	0.000s	○								
P06.07	Y1 switch-off delay	Setting range: 0.000–50.000s	0.000s	○								
P06.10	RO1 switch-on delay	The function code defines the delay time corresponding to the electrical level changes when the programmable output terminals switch on or switch off. 	0.000s	○								
P06.11	RO1 switch-off delay		0.000s	○								
P06.12	RO2 switch-on delay		0.000s	○								
P06.13	RO2 switch-off delay		Setting range : 0.000–50.000s	0.000s	○							
P06.14	AO1 output		0: Running frequency 1: Setting frequency	0	○							
P06.15	AO2 output	2: Ramp reference frequency 3: Running rotation speed (100% corresponds to the speed corresponding to max. output frequency)	0	○								

Function code	Name	Description	Default	Modify
		4: Output current (100% corresponds to twice the VFD rated current) 5: Output current (100% corresponds to twice the motor rated current) 6: Output voltage (100% corresponds to 1.5 times the VFD rated voltage) 7: Output power (100% corresponds to twice the motor rated power) 8: Set torque (100% corresponds to twice the motor rated torque) 9: Output torque (Absolute value, 100% corresponds to twice the motor rated torque) 10: AI1 input 11: AI2 input 12: AI3 input 13: High speed pulse HDI input 14: Value 1 set through Modbus communication 15: Value 2 set through Modbus communication 16–21: Reserved 22: Torque current (100% corresponds to triple the motor rated current) 23: Ramp reference frequency (with sign) 24–30: Reserved		
P06.17	Lower limit of AO1 output	The function codes define the relationship between the output value and analog output. When the output value exceeds the allowed range, the output uses the lower limit or upper limit. When the analog output is current output, 1 mA equals to 0.5 V. In different cases, the corresponding analog output of 100% of the output value is different.	0.0%	<input type="radio"/>
P06.18	Corresponding AO1 output to the lower limit		0.00V	<input type="radio"/>
P06.19	Upper limit of AO1 output		100.0%	<input type="radio"/>

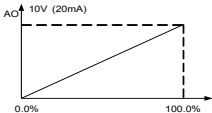
Function code	Name	Description	Default	Modify
P06.20	Corresponding AO1 output to the upper limit	 <p>Setting range of P06.17: -100.0%–P06.19</p>	10.00V	<input type="radio"/>
P06.21	AO1 output filter time	<p>Setting range of P06.18: 0.00V–10.00V</p> <p>Setting range of P06.19: P06.17–100.0%</p> <p>Setting range of P06.20: 0.00V–10.00V</p>	0.000s	<input type="radio"/>
P06.22	Lower limit of AO2 output	<p>Setting range of P06.21: 0.000s–10.000s</p> <p>Setting range of P06.22: -100.0%–P06.24</p> <p>Setting range of P06.23: 0.00V–10.00V</p> <p>Setting range of P06.24: P06.22–100.0%</p>	0.0%	<input type="radio"/>
P06.23	Corresponding AO2 output to the lower limit	<p>Setting range of P06.25: 0.00V–10.00V</p> <p>Setting range of P06.26: 0.000s–10.000s</p>	0.00V	<input type="radio"/>
P06.24	Upper limit of AO2 output		100.0%	<input type="radio"/>
P06.25	Corresponding AO2 output to the upper limit		10.00V	<input type="radio"/>
P06.26	AO2 output filter time		0.000s	<input type="radio"/>

P07 group HMI

Function code	Name	Description	Default	Modify
P07.00	User password	0–65535 When you set the function code to a	0	<input type="radio"/>

Function code	Name	Description	Default	Modify
		<p>non-zero number, password protection is enabled.</p> <p>If you set the function code to 00000, the previous user password is cleared and password protection is disabled.</p> <p>After the user password is set and takes effect, you cannot enter the parameter menu if you enter an incorrect password. Please remember your password and save it in a secure place.</p> <p>After you exit the function code editing interface, the password protection function is enabled within 1 minute. If password protection is enabled, "0.0.0.0.0" is displayed when you press the PRG/ESC key again to enter the function code editing interface. You need to enter the correct user password to enter the interface.</p> <p>Note: Restoring to the default value may delete the user password. Exercise caution when using this function.</p>		
P07.01	Parameter copy	<p>0: No operation</p> <p>1: Upload the local function parameter to the keypad</p> <p>2: Download the keypad function parameter to local address (including the motor parameters)</p> <p>3: Download the keypad function parameter to local address (excluding the motor parameter of P02 and P12 group)</p> <p>4: Download the keypad function parameters to local address (only for the motor parameter of P02 and P12 group)</p> <p>Note: After the parameter is set to 1, 2, 3 or 4, and the operation is executed, the parameter is automatically restored to 0. The parameters uploaded or downloaded do not include those of the P29 group</p>	0	©

Function code	Name	Description	Default	Modify
		(factory function parameters). The function is valid only for the optional external keypad with the function of parameter copying.		
P07.02	QUICK key function selection	0x00–0x27 Ones place: Function of QUICK/JOG key 0: No function 1: Jog 2: Switch display state via shift key 3: Switch between FWD and REV rotating 4: Clear the UP/DOWN setting 5: Coast to stop 6: Switch command channels in sequence 7: Quick Commissioning mode (based on non-default parameter) Tens place: Key locking selection 0: Keys unlocked 1: Lock all keys 2: Lock part of the keys (lock PRG/ESC key only)	0x01	⊙
P07.03	Sequence of switching running command channels by pressing QUICK/JOG	When the one place of P07.02 =6, set the sequence of switching running command channels by pressing this key. 0: Keypad→Terminal→Communication 1: Keypad←→Terminal 2: Keypad←→Communication 3: Terminal←→Communication	0	○
P07.04	Stop function validity of STOP/RST	The function code specifies the stop function validity of STOP/RST . For fault reset, STOP/RST is valid in any conditions. 0: Valid only for keypad control 1: Valid both for keypad and terminal control 2: Valid both for keypad and communication control 3: Valid for all control modes	0	○

Function code	Name	Description	Default	Modify
P07.05	Displayed parameters 1 of running state	0x0000–0xFFFF BIT0: Running frequency (Hz on) BIT1: Set frequency (Hz flickering) BIT2: Bus voltage (V on) BIT3: Output voltage (V on) BIT4: Output current (A on) BIT5: Running rotation speed (rpm on) BIT6: Output power (% on) BIT7: Output torque (% on) BIT8: PID reference (% flickering) BIT9: PID feedback (% on) BIT10: Input terminal state BIT11: Output terminal state BIT12: Torque setting (% on) BIT13: Pulse counting BIT14: Reserved BIT15: PLC and current step of multi-step speed	0x03FF	○
P07.06	Displayed parameters 2 of running state	0x0000–0xFFFF BIT0: AI1 (V on) BIT1: AI2 (V on) BIT2: AI3 (V on) BIT3: High-speed pulse HDI frequency BIT4: Motor overload percentage (% on) BIT5: VFD overload percentage (% on) BIT6: Ramp frequency reference (Hz on) BIT7: Linear speed BIT8: AC incoming current (A on) BIT9–15: Reserved	0x0000	
P07.07	Parameter selection of the stop state	0x0000–0xFFFF BIT0: Set frequency (Hz on, frequency flickering slowly) BIT1: Bus voltage (V on) BIT2: Input terminal state BIT3: Output terminal state BIT4: PID reference (% flickering) BIT5: PID feedback (% on) BIT6: Torque reference (% flickering) BIT7: AI1 (V on)	0x00FF	○

Function code	Name	Description	Default	Modify
		BIT8: AI2 (V on) BIT9: AI3 (V on) BIT10: High-speed pulse HDI frequency BIT11: PLC and current step of multi-step speed BIT12: Pulse counting BIT13–BIT15: Reserved		
P07.08	Frequency display coefficient	0.01–10.00 Displayed frequency = Running frequency x P07.08	1.00	○
P07.09	Speed display coefficient	0.1–999.9% Mechanical rotation speed = 120 x (Displayed running frequency) x P07.09 /(Number of motor poles)	100.0%	○
P07.10	Linear speed displayed coefficient	0.1–999.9% Linear speed= (Mechanical rotation speed) x P07.10	1.0%	○
P07.11	Rectifier bridge temperature	-20.0–120.0°C	0.0°C	●
P07.12	Inverter temperature	-20.0–120.0°C	0.0°C	●
P07.13	Control board software version	1.00–655.35	Depend on model	●
P07.14	Local accumulative running time	0–65535 h	0h	●
P07.15	MSB of power consumption	The function codes are used to display the power consumption of the VFD.	0kWh	●
P07.16	LSB of power consumption	VFD power consumption = P07.15 x1000 + P07.16 Setting range of P07.15 : 0–65535kWh (x1000) Setting range of P07.16 : 0.0–999.9kWh	0.0kWh	●
P07.17	Reserved	Reserved		●
P07.18	Rated power of the VFD	0.4–3000.0kW	0.4kW	●

Function code	Name	Description	Default	Modify
P07.19	Rated voltage of the VFD	50–1200V	380V	●
P07.20	Rated current of the VFD	0.1–6000.0A	0.1A	●
P07.21	Factory bar code 1	0x0000–0xFFFF	0xFFFF	●
P07.22	Factory bar code 2	0x0000–0xFFFF	0xFFFF	●
P07.23	Factory bar code 3	0x0000–0xFFFF	0xFFFF	●
P07.24	Factory bar code 4	0x0000–0xFFFF	0xFFFF	●
P07.25	Factory bar code 5	0x0000–0xFFFF	0xFFFF	●
P07.26	Factory bar code 6	0x0000–0xFFFF	0xFFFF	●
P07.27	Present fault type	0: No fault	0	●
P07.28	The last fault type	1: Inverter unit U phase protection (OUT1) 2: Inverter unit V phase protection (OUT2) 3: Inverter unit W phase protection (OUT3)	0	●
P07.29	The last but one fault type	4: Overcurrent during acceleration (OC1) 5: Overcurrent during deceleration (OC2)	0	●
P07.30	The last but two fault type	6: Overcurrent during constant speed running (OC3)	0	●
P07.31	The last but three fault type	7: Overvoltage during acceleration (OV1) 8: Overvoltage during deceleration (OV2) 9: Overvoltage during constant speed running (OV3)	0	●
P07.32	The last but four fault type	10: Bus undervoltage (UV) 11: Motor overload (OL1) 12: VFD overload (OL2) 13: Phase loss on input side (SPI) 14: Phase loss on output side (SPO) 15: Rectifier module overheat (OH1) 16: Inverter module overheat (OH2) 17: External fault (EF) 18: 485 communication fault (CE) 19: Current detection fault (ItE)	0	●

Function code	Name	Description	Default	Modify
		20: Motor autotuning fault (tE) 21: EEPROM operation fault (EEP) 22: PID feedback offline fault (PIDE) 23: Braking unit fault (bCE) 24: Running time reached (END) 25: Electronic overload (OL3) 26: Keypad communication error (PCE) 27: Parameter upload error (UPE) 28: Parameter download error (DNE) 29–31: Reserved 32: To-ground short-circuit fault 1 (ETH1) 33: To-ground short-circuit fault 2 (ETH2) 34: Speed deviation fault (dEu) 35: Mal-adjustment fault (STo) 36: Underload fault (LL)		
P07.33	Running frequency at present fault	0.00–630.00Hz	0.00Hz	●
P07.34	Ramp reference frequency at present fault	0.00–630.00Hz	0.00Hz	●
P07.35	Output voltage at present fault	0–1200V	0V	●
P07.36	Output current at present fault	0.0–6300.0A	0.0A	●
P07.37	Current bus voltage at present fault	0.0–2000.0V	0.0V	●
P07.38	Temperature at present fault	0.0–120.0°C	0.0°C	●
P07.39	Input terminal state at present fault	0x0000–0xFFFF	0x0000	●

Function code	Name	Description	Default	Modify
P07.40	Output terminal state at present fault	0x0000–0xFFFF	0x0000	●
P07.41	Reference frequency at the last fault	0.00–630.00Hz	0.00Hz	●
P07.42	Ramp reference frequency at the last fault	0.00–630.00Hz	0.00Hz	●
P07.43	Output voltage at last fault	0–1200V	0V	●
P07.44	Output current at last fault	0.0–6300.0A	0.0A	●
P07.45	Bus voltage at last fault	0.0–2000.0V	0.0V	●
P07.46	Temperature at last fault	0.0–120.0°C	0.0°C	●
P07.47	Input terminal state at last fault	0x0000–0xFFFF	0x0000	●
P07.48	Output terminal state at last fault	0x0000–0xFFFF	0x0000	●
P07.49	Running frequency at the last but one faults	0.00–630.00Hz	0.00Hz	●
P07.50	Ramp reference frequency at the last but one faults	0.00–630.00Hz	0.00Hz	●
P07.51	Output voltage at the last but one faults	0–1200V	0V	●

Function code	Name	Description	Default	Modify
P07.52	Output current at the last but one faults	0.0–6300.0A	0.0A	●
P07.53	Bus voltage at the last but one faults	0.0–2000.0V	0.0V	●
P07.54	Temperature at the last but one faults	0.0–120.0°C	0.0°C	●
P07.55	Input terminal state at the last but one faults	0x0000–0xFFFF	0x0000	●
P07.56	Output terminal state at the last but one faults	0x0000–0xFFFF	0x0000	●

P08 group Enhanced functions

Function code	Name	Description	Default	Modify
P08.00	ACC time 2	Refer to P00.11 and P00.12 for detailed definition. The VFD has four groups of ACC/DEC time which can be selected by P5 group. The first group of ACC/DEC time is the factory default one. Setting range: 0.0–3600.0s	Depend on model	○
P08.01	DEC time 2		Depend on model	○
P08.02	ACC time 3		Depend on model	○
P08.03	DEC time 3		Depend on model	○
P08.04	ACC time 4		Depend on model	○
P08.05	DEC time 4		Depend on model	○
P08.06	Running frequency of jog	The function code is used to define the reference frequency during jogging. Setting range: 0.00Hz– P00.03 (max. output frequency)	5.00Hz	○

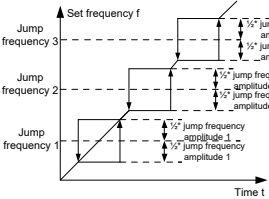
Function code	Name	Description	Default	Modify
P08.07	ACC time for jog	ACC time for jogging means the time needed for the VFD to accelerate from 0Hz to the max. output frequency (P00.03).	Depend on model	○
P08.08	DEC time for jog	DEC time for jogging means the time needed for the VFD to decelerate from the max. output frequency (P00.03) to 0Hz. Setting range: 0.0–3600.0s	Depend on model	○
P08.09	Jump frequency 1	When the set frequency is within the range of jumping frequency, the VFD runs at the boundary of jumping frequency.	0.00Hz	○
P08.10	Jump frequency amplitude 1	The VFD can avoid the mechanical resonance point by setting jumping frequencies. The VFD supports the setting of three jump frequencies. If the jump frequency points are set to 0, this function is invalid.	0.00Hz	○
P08.11	Jump frequency 2		0.00Hz	○
P08.12	Jump frequency amplitude 2		0.00Hz	○
P08.13	Jump frequency 3		0.00Hz	○
P08.14	Jump frequency amplitude 3	 <p>Setting range: 0.00–P00.03 (max. output frequency)</p>	0.00Hz	○
P08.15	Amplitude of wobbling frequency	This function applies to the industries where traverse and convolution function are required such as textile and chemical fiber.	0.0%	○
P08.16	Amplitude of sudden jump frequency	The traverse function means that the output frequency of the VFD is fluctuated with the set frequency as its center. The route of the traverse function is illustrated as follows, of which the traverse is set by P08.15 and when P08.15 is set as 0, the traverse is 0 with no function.	0.0%	○
P08.17	Rise time of wobbling frequency		5.0s	○
P08.18	Fall time of wobbling		5.0s	○

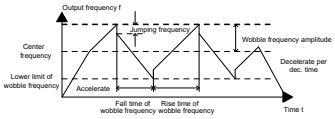
Function code	Name	Description	Default	Modify
	frequency	 <p>Amplitude of wobbling frequency: The wobbling frequency running is limited by upper and low limits of the frequency.</p> <p>The traverse range relative to the center frequency: traverse range $AW = \text{center frequency} \times \text{traverse range}$ P08.15.</p> <p>Sudden jump frequency = Amplitude of wobbling frequency $AW \times$ Amplitude of sudden jump frequency (P08.16), that is, the value that the sudden jump frequency corresponds to the wobbling frequency when the VFD runs at the wobbling frequency.</p> <p>Rise time of wobbling frequency: Time needed for the VFD to run from the lowest point to the highest one.</p> <p>Fall time of wobbling frequency: The time needed for the VFD to from the highest point to the lowest one.</p> <p>Setting range of P08.15: 0.0–100.0% (relative to the set frequency)</p> <p>Setting range of P08.16: 0.0–50.0% (relative to the amplitude of wobbling frequency)</p> <p>Setting range of P08.17 and P08.18: 0.1–3600.0s</p>		
P08.19	Number of decimal places of linear speed/frequency	0x00–0x13 Ones place: Linear speed displays number of decimal places 0: No decimal place 1: One 2: Two 3: Three Tens place: Frequency displays number of	0x00	○

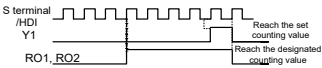
Function code	Name	Description	Default	Modify
		decimal places 0: Two 1: One		
P08.20	Analog calibration function	0: Disable 1: Enable	1	☉
P08.21	DEC time of emergency stop	0.0–6553.5 s 0.0 indicates coast to stop.	0.0s	○
P08.22	Delay to enter the sleep state	0.0–3600.0s It indicates the delay to enter the sleep state, and it is valid only when ones place of P01.19 is set to 2.	2.0s	○
P08.24	Energy braking for stop	Setting range: 0–1 0: Disable 1: Enable	1	○
P08.25	Set counting value	The counter works by the input terminal signals of S terminal (set as "Counter trigger") or HDI (set P05.00 to 1).	0	○
P08.26	Designated counting value	When the counter achieves a fixed number, the multi-function output terminals will output the signal of "fixed counting number arrival" and the counter go on working; when the counter achieves a setting number, the multi-function output terminals will output the signal of "setting counting number arrival", the counter will clear all numbers and stop to recount before the next pulse. The setting counting value P08.26 should be no more than the setting counting value P08.25 . The function is illustrated as follows.  <p>Setting range of P08.25: P08.26–65535 Setting range of P08.26: 0–P08.25</p>	0	○

Function code	Name	Description	Default	Modify
P08.27	Setting running time	Pre-set running time of the VFD. When the accumulative running time achieves the set time, the multi-function digital output terminals will output the signal of "running time arrival". Setting range: 0–65535 min	0 m	<input type="radio"/>
P08.28	Auto fault reset count	Auto fault reset count: When the VFD uses automatic fault reset, it is used to set the number of automatic fault reset times. When the number of continuous reset times exceeds the value, the VFD reports a fault and stops.	0	<input type="radio"/>
P08.29	Interval time of auto fault reset	Interval time of auto fault reset: Time interval from when a fault occurred to when automatic fault reset takes effect. Setting range of P08.28 : 0–10 Setting range of P08.29 : 0.1–100.0s	1.0s	<input type="radio"/>
P08.30	Frequency decrease ratio in drop control	The output frequency of the VFD changes as the load changes. The function code is mainly used to balance the power when several motors drive a same load. Setting range: -50.00Hz–+50.00Hz	0.00Hz	<input type="radio"/>
P08.32	FDT1 electrical level detection value	When the output frequency exceeds the corresponding frequency of FDT electrical level, the multi-function digital output terminals continuously outputs the signal of "Frequency level detect FDT". The signal is invalid only when the output frequency decreases to a value lower than the frequency corresponding to (FDT electrical level—FDT lagging detection value) The waveform diagram is as follows:	50.00Hz	<input type="radio"/>
P08.33	FDT1 lagging detection value		5.0%	<input type="radio"/>
P08.34	FDT2 electrical level detection value		50.00Hz	<input type="radio"/>

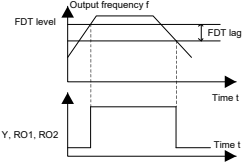
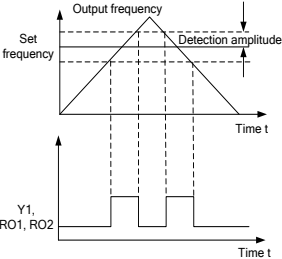
Function code	Name	Description	Default	Modify
P08.35	FDT2 lagging detection value	 <p>Setting range of P08.32: 0.00Hz–P00.03 (max output frequency) Setting range of P08.33 and P08.35: 0.0–100.0% Setting range of P08.34: 0.00Hz–P00.03 (max output frequency)</p>	5.0%	<input type="radio"/>
P08.36	Detection value for frequency being reached	<p>When the output frequency is within the detection range, the multi-function digital output terminal outputs the signal of "Frequency reached".</p>  <p>Setting range: 0.00Hz–P00.03 (max output frequency)</p>	0.00Hz	<input type="radio"/>
P08.37	Enabling energy consumption braking	<p>The function code is used to control enabling of the brake tube action inside the VFD.</p> <p>0: Disable 1: Enable</p> <p>Note: It is only applicable to VFD models that are built in braking tubes.</p>	0	<input type="radio"/>

Function code	Name	Description	Default	Modify
P08.38	Energy consumption braking threshold voltage	The function code is used to set the starting bus voltage of energy consumption braking. Adjust this value properly to achieve effective braking for the load. The default value varies depending on the voltage class. Setting range: 200.0–2000.0V	220V voltage: 380.0V 380V voltage: 700.0V	○
P08.39	Cooling fan running mode	Setting range: 0–2 0: Common running mode 1: The fan keeps running after being powered on 2: Running mode 2	0	○
P08.40	PWM selection	0x0000–0x1121 Ones place: PWM mode selection 0: PWM mode 1, 3PH modulation and 2PH modulation 1: PWM mode 2, 3PH modulation Tens place: PWM low-speed carrier limit 0: Low-speed carrier limit mode 1 1: Low-speed carrier limit mode 2 2: No limit Hundreds place: Reserved Thousands place: PWM loading mode selection 0: Normal loading 1: Interruptive loading	0x0001	◎
P08.41	Overmodulation	0x00–0x11 Ones place: Whether to enable overmodulation 0: Disable overmodulation 1: Enable overmodulation Tens place: Overmodulation mode 0: Mild overmodulation 1: Deepened overmodulation	0x01	◎
P08.42	Data control set through keypad	0x0000–0x1223 Ones place: Frequency enable selection 0: Both \wedge / \vee keys and analog potentiometer adjustments are valid	0x0000	○

Function code	Name	Description	Default	Modify
		1: Only \wedge/\vee keys adjustment is valid 2: Only analog potentiometer adjustments is valid 3: Neither \wedge / \vee keys nor digital potentiometer adjustments are valid Tens place: Frequency control selection 0: Valid only when P00.06 =0 or P00.07 =0 1: Valid for all frequency setting manner 2: Invalid for multi-step speed when multi-step speed has the priority Hundreds place: Action selection during stopping 0: Setting is valid 1: Valid during running, cleared after stopping 2: Valid during running, cleared after receiving the stop command Thousands place: \wedge/\vee keys and analog potentiometer integral function 0: The integral function is enabled 1: The integral function is disabled		
P08.43	Integral ratio of the keypad potentiometer	0.01–10.00s	0.10s	○
P08.44	UP/DOWN terminal control setting	0x000–0x221 Ones place: Frequency setting selection 0: The setting made through UP/DOWN terminal is valid 1: The setting made through UP/DOWN terminal is invalid Tens place: Frequency control selection 0: Valid only when P00.06 =0 or P00.07 =0 1: Valid for all frequency setting methods 2: Invalid for multi-step speed running when multi-step speed running has the priority LED hundreds: Action selection for stop 0: Setting is valid	0x000	○

Function code	Name	Description	Default	Modify
		1: Valid during running, cleared after stop 2: Valid during running, cleared after a stop command is received		
P08.45	Frequency increment integral rate of the UP terminal	0.01–50.00s	0.50s	○
P08.46	Frequency integral rate of the DOWN terminal	0.01–50.00s	0.50s	○
P08.47	Action selection at power-off during frequency setting	0x000–0x111 Ones place: Action selection at power-off during frequency adjusting through digitals. 0: Save the setting at power-off 1: Clear the setting at power-off Tens place: Action selection at power-off during frequency setting through Modbus communication 0: Save the setting at power-off 1: Clear the setting at power-off Hundreds place: Action selection at power-off during frequency setting through other communication methods 0: Save the setting at power-off 1: Clear the setting at power-off	0x000	○
P08.48	MSB of initial power consumption	This parameter is used to set the initial power consumption. Initial power consumption = P08.48 × 1000 +	0	○
P08.49	LSB of initial power consumption	P08.49 (kWh) Setting range of P08.48 : 0–59999 Setting range of P08.49 : 0.0–999.9	0.0	○
P08.50	Magnetic flux braking	This function code is used to enable magnetic flux braking. 0: Invalid.	0	○

Function code	Name	Description	Default	Modify
		<p>100–150: A greater coefficient indicates greater braking strength.</p> <p>The VFD can quickly slow down the motor by increasing the magnetic flux. The energy generated by the motor during braking can be transformed into heat energy by increasing the magnetic flux.</p> <p>The VFD monitors the state of the motor continuously even during the magnetic flux period. So the magnetic flux can be used for motor stop, as well as for motor rotation speed change. Its other advantages include: Braking is performed immediately after the stop command is given. The braking can be started without waiting for magnetic flux weakening.</p> <p>The cooling is better. The current of the stator other than the rotor increases during magnetic flux braking, while the cooling of the stator is more effective than the rotor.</p>		
P08.51	VFD input power factor	This function code is used to adjust the displayed current on the AC input side. Setting range: 0.00–1.00	0.56	<input type="radio"/>

P09 group PID control

Function code	Name	Description	Default	Modify
P09.00	PID reference source	<p>When the frequency command selection (P00.06, P00.07) is 7 or the voltage setting channel selection (P04.27) is 6, the VFD is process PID controlled.</p> <p>The function code determines the target given channel during the PID process.</p> <p>0: P09.01 1: AI1 2: AI2 3: AI3 4: High speed pulse HDI 5: Multi-step running</p>	0	<input type="radio"/>

Function code	Name	Description	Default	Modify
		6: Modbus communication 7–9: Reserved The set target of process PID is a relative value, for which 100% equals to 100% of the feedback signal of the controlled system. The system always calculates a related value (0–100.0%). Note: Multi-step running reference can be achieved by setting P10 group parameters.		
P09.01	PID value reference	The function code is mandatory when P09.00 =0. The base value of the function code is the feedback of the system. Setting range: -100.0%–100.0%	0.0%	<input type="radio"/>
P09.02	PID feedback source	The function code is used to select PID feedback channel. 0: AI1 1: AI2 2: AI3 3: High speed HDI 4: Modbus communication 5: MAX (AI2 and AI3) 6–7: Reserved Note: The reference channel and feedback channel cannot be duplicate. Otherwise, effective PID control cannot be achieved.	0	<input type="radio"/>
P09.03	PID output characteristics	0: PID output is positive. When the feedback signal is greater than the PID reference value, the output frequency of the VFD will decrease to balance the PID. Example: PID control on strain during unwinding. 1: PID output is negative. When the feedback signal is greater than the PID reference value, the output frequency of the VFD will increase to balance the PID. Example: PID control on strain during unwinding.	0	<input type="radio"/>
P09.04	Proportional gain at high	The function is applied to the proportional gain P of PID input. P determines the strength of the whole PID	1.00	<input type="radio"/>

Function code	Name	Description	Default	Modify
	frequency (Kp)	adjuster. The value 100 indicates that when the difference between the PID feedback value and given value is 100%, the range within which the PID regulator can regulate the output frequency command is the max. frequency (ignoring integral function and differential function). Setting range: 0.00–100.00		
P09.05	Integral time at high frequency (Ti)	It determines the speed of integral regulation made on the deviation between PID feedback and reference by PID regulator. When the deviation between PID feedback and reference is 100%, the regulation of integral regulator (ignoring integral and differential actions), after undergoing continuous regulation during this time period, can reach max. output frequency (P00.03) or max. output voltage (P04.31). The shorter the integral time, the stronger the regulation intensity. Setting range: 0.00–10.00s	0.10s	○
P09.06	Differential time at high frequency (Td)	It determines the intensity of the regulation made on the change rate of deviation between PID feedback and reference by PID regulator. If feedback changes by 100% during this period, the regulation of differential regulator (ignoring integral and differential actions) is max. output frequency (P00.03) or max. output voltage (P04.31). The longer the differential time, the stronger the regulation intensity. Setting range: 0.00–10.00s	0.00s	○
P09.07	Sampling cycle (T)	It means the sampling cycle of feedback. The regulator operates once during each sampling cycle. The larger the sampling cycle, the slower the response. Setting range: 0.001–10.000s	0.100s	○

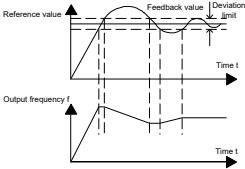
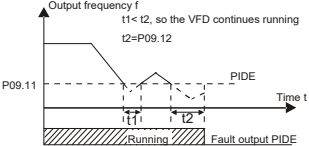
Function code	Name	Description	Default	Modify
P09.08	Limit of PID control deviation	<p>It is the max. allowable deviation of PID system output value relative to closed-loop reference value. Within this limit, PID regulator stops regulation. Set this function code properly to regulate the precision and stability of PID system.</p>  <p>Setting range: 0.0–100.0%</p>	0.0%	<input type="radio"/>
P09.09	Upper limit value of PID output	<p>The two function codes are used to set the upper /lower limit value of PID regulator. 100.0% corresponds to max. output frequency (P00.03) or max. output voltage (P04.31).</p> <p>Setting range of P09.09: P09.10–100.0%</p> <p>Setting range of P09.10: -100.0%–P09.09</p>	100.0%	<input type="radio"/>
P09.10	Lower limit value of PID output		0.0%	<input type="radio"/>
P09.11	Feedback offline detection value	<p>Set the PID feedback offline detection value, when the detection value is no more than the feedback offline detection value, and the duration exceeds the value set in P09.12, the VFD will report "PID feedback offline fault", and keypad displays PIDE.</p>	0.0%	<input type="radio"/>
P09.12	Feedback offline detection time	 <p>Setting range of P09.11: 0.0–100.0%</p> <p>Setting range of P09.12: 0.0–3600.0s</p>	1.0s	<input type="radio"/>
P09.13	PID control selection	<p>0x0000–0x1111</p> <p>Ones place:</p>	0x0001	<input type="radio"/>

Function code	Name	Description	Default	Modify
		0: Continue integral control after the frequency reaches upper/lower limit 1: Stop integral control after the frequency reaches upper/lower limit Tens place: 0: The same with the main reference direction 1: Contrary to the main reference direction Hundreds place: 0: Limit based on the max. frequency 1: Limit based on A frequency Thousands place: 0: A+B frequency, ACC/DEC of main reference A frequency source buffering is invalid 1: A+B frequency, ACC/DEC of main reference A frequency source buffering is valid, ACC and DEC are determined by P08.04 (ACC time 4)		
P09.14	Reserved			
P09.15	ACC/DEC time of PID command	0.0–1000.0s	0.0s	<input type="radio"/>
P09.16	PID output filter time	0.000–10.000s	0.000s	<input type="radio"/>
P09.17	Proportional gain at low frequency (Kp)	0.00–100.00	1.00	<input type="radio"/>
P09.18	Integral time at low frequency (Ti)	0.00–10.00s	0.10s	<input type="radio"/>
P09.19	Differential time at low frequency (Td)	0.00–10.00s	0.00s	<input type="radio"/>
P09.20	Low-point frequency	0.00Hz– P09.21	5.00Hz	<input type="radio"/>

Function code	Name	Description	Default	Modify
	for switching PI parameters	When the ramp frequency is less than or equal to P09.20 , the present PID parameters range from P09.17 to P09.19 . When the ramp frequency is greater than or equal to P09.21 , the present PI parameters range from P09.04 to P09.06 . The intermediate frequency band is the linear interpolation between high and low-point frequency.		
P09.21	High-point frequency for switching PI parameters	P09.20 – P00.03	10.00Hz	<input type="radio"/>

P10 group Simple PLC and multi-step speed control

Function code	Name	Description	Default	Modify
P10.00	Simple PLC mode	0: Stop after running once; the VFD stops automatically after running for one cycle, and it can be started only after receiving running command. 1: Keep running in the final value after running once. The VFD keeps the running frequency and direction of the last section after a single cycle. 2: Cyclic running; the VFD enters the next cycle after completing one cycle until receiving stop command and stops.	0	<input type="radio"/>
P10.01	Simple PLC memory selection	0: No memory after power-off 1: Memory after power-off; PLC memories its running step and frequency before power-off.	0	<input type="radio"/>
P10.02	Multi-step speed 0	100.0% of the frequency setting corresponds to max. output frequency (P00.03).	0.0%	<input type="radio"/>
P10.03	Running time of step 0	When simple PLC operation is selected, it is required to set P10.02 – P10.33 to determine	0.0s	<input type="radio"/>

Function code	Name	Description	Default	Modify
P10.04	Multi-step speed 1	the running frequency and running direction of each step.	0.0%	<input type="radio"/>
P10.05	Running time of step 1	Note: The symbol of multi-step speed determines the running direction of simple PLC, and the negative value means reverse running.	0.0s	<input type="radio"/>
P10.06	Multi-step speed 2		0.0%	<input type="radio"/>
P10.07	Running time of step 2		0.0s	<input type="radio"/>
P10.08	Multi-step speed 3		0.0%	<input type="radio"/>
P10.09	Running time of step 3	Multi-step speeds are within the range of $-f_{max} \sim f_{max}$, and they can be set continuously.	0.0s	<input type="radio"/>
P10.10	Multi-step speed 4	The VFD supports the setting of speeds of 16 steps, which are set by combined codes of multi-step terminals 1-4, and correspond to multi-step speed 0 to multi-step speed 15.	0.0%	<input type="radio"/>
P10.11	Running time of step 4		0.0s	<input type="radio"/>
P10.12	Multi-step speed 5		0.0%	<input type="radio"/>
P10.13	Running time of step 5	0.0s	<input type="radio"/>	
P10.14	Multi-step speed 6	0.0%	<input type="radio"/>	
P10.15	Running time of step 6	0.0s	<input type="radio"/>	
P10.16	Multi-step speed 7	When terminal 1, terminal 2, terminal 3 and terminal 4 are OFF, the frequency input mode is set by P00.06 or P00.07 . When terminal 1, terminal 2, terminal 3 and terminal 4 are not all OFF, the frequency set by multi-step speed	0.0%	<input type="radio"/>
P10.17	Running time of step 7		0.0s	<input type="radio"/>
P10.18	Multi-step speed 8	0.0%	<input type="radio"/>	

Function code	Name	Description	Default	Modify																			
P10.19	Running time of step 8	will prevail, and the priority of multi-step setting is higher than that of the keypad, analog, high-speed pulse, PLC, and communication frequency input. A maximum of speeds of 16 steps can be set by combined codes of terminal 1, terminal 2, terminal 3, and terminal 4. The start-up and stopping of multi-step running is determined by P00.06 . The relation between terminal 1, terminal 2, terminal 3, terminal 4 and multi-step speed are as following:	0.0s	<input type="radio"/>																			
P10.20	Multi-step speed 9		0.0%	<input type="radio"/>																			
P10.21	Running time of step 9		0.0s	<input type="radio"/>																			
P10.22	Multi-step speed 10		0.0%	<input type="radio"/>																			
P10.23	Running time of step 10		0.0s	<input type="radio"/>																			
P10.24	Multi-step speed 11		<table border="1"> <tr> <td>Terminal 1</td> <td>OFF</td> <td>ON</td> <td>OFF</td> <td>ON</td> <td>OFF</td> <td>ON</td> <td>OFF</td> <td>ON</td> </tr> </table>	Terminal 1	OFF	ON	OFF	ON	OFF	ON	OFF	ON	0.0%	<input type="radio"/>									
Terminal 1	OFF		ON	OFF	ON	OFF	ON	OFF	ON														
P10.25	Running time of step 11		<table border="1"> <tr> <td>Terminal 2</td> <td>OFF</td> <td>OFF</td> <td>ON</td> <td>ON</td> <td>OFF</td> <td>OFF</td> <td>ON</td> <td>ON</td> </tr> <tr> <td>Terminal 3</td> <td>OFF</td> <td>OFF</td> <td>OFF</td> <td>OFF</td> <td>ON</td> <td>ON</td> <td>ON</td> <td>ON</td> </tr> </table>	Terminal 2	OFF	OFF	ON	ON	OFF	OFF	ON	ON	Terminal 3	OFF	OFF	OFF	OFF	ON	ON	ON	ON	0.0s	<input type="radio"/>
Terminal 2	OFF		OFF	ON	ON	OFF	OFF	ON	ON														
Terminal 3	OFF		OFF	OFF	OFF	ON	ON	ON	ON														
P10.26	Multi-step speed 12	<table border="1"> <tr> <td>Terminal 4</td> <td>OFF</td> <td>OFF</td> <td>OFF</td> <td>OFF</td> <td>OFF</td> <td>OFF</td> <td>OFF</td> <td>OFF</td> </tr> <tr> <td>Step</td> <td>0</td> <td>1</td> <td>2</td> <td>3</td> <td>4</td> <td>5</td> <td>6</td> <td>7</td> </tr> </table>	Terminal 4	OFF	OFF	OFF	OFF	OFF	OFF	OFF	OFF	Step	0	1	2	3	4	5	6	7	0.0%	<input type="radio"/>	
Terminal 4	OFF	OFF	OFF	OFF	OFF	OFF	OFF	OFF															
Step	0	1	2	3	4	5	6	7															
P10.27	Running time of step 12	<table border="1"> <tr> <td>Terminal 1</td> <td>OFF</td> <td>ON</td> <td>OFF</td> <td>ON</td> <td>OFF</td> <td>ON</td> <td>OFF</td> <td>ON</td> </tr> </table>	Terminal 1	OFF	ON	OFF	ON	OFF	ON	OFF	ON	0.0s	<input type="radio"/>										
Terminal 1	OFF	ON	OFF	ON	OFF	ON	OFF	ON															
P10.28	Multi-step speed 13	<table border="1"> <tr> <td>Terminal 2</td> <td>OFF</td> <td>OFF</td> <td>ON</td> <td>ON</td> <td>OFF</td> <td>OFF</td> <td>ON</td> <td>ON</td> </tr> </table>	Terminal 2	OFF	OFF	ON	ON	OFF	OFF	ON	ON	0.0%	<input type="radio"/>										
Terminal 2	OFF	OFF	ON	ON	OFF	OFF	ON	ON															
P10.29	Running time of step 13	<table border="1"> <tr> <td>Terminal 3</td> <td>OFF</td> <td>OFF</td> <td>OFF</td> <td>OFF</td> <td>ON</td> <td>ON</td> <td>ON</td> <td>ON</td> </tr> </table>	Terminal 3	OFF	OFF	OFF	OFF	ON	ON	ON	ON	0.0s	<input type="radio"/>										
Terminal 3	OFF	OFF	OFF	OFF	ON	ON	ON	ON															
P10.30	Multi-step speed 14	<table border="1"> <tr> <td>Terminal 4</td> <td>ON</td> <td>ON</td> <td>ON</td> <td>ON</td> <td>ON</td> <td>ON</td> <td>ON</td> <td>ON</td> </tr> <tr> <td>step</td> <td>8</td> <td>9</td> <td>10</td> <td>11</td> <td>12</td> <td>13</td> <td>14</td> <td>15</td> </tr> </table>	Terminal 4	ON	ON	ON	ON	ON	ON	ON	ON	step	8	9	10	11	12	13	14	15	0.0%	<input type="radio"/>	
Terminal 4	ON	ON	ON	ON	ON	ON	ON	ON															
step	8	9	10	11	12	13	14	15															
P10.31	Running time of step 14	Setting range of P10.(2n, 1<n<17): -100.0–100.0%	0.0s	<input type="radio"/>																			
P10.32	Multi-step speed 15	Setting range of P10.(2n+1, 1<n<17): 0.0–6553.5 s (min)	0.0%	<input type="radio"/>																			
P10.33	Running time of step 15		0.0s	<input type="radio"/>																			

Function code	Name	Description	Default	Modify																																																																																																					
P10.34	Simple PLC 0-7 step ACC/DEC time selection	Below is the detailed instruction:	0x0000	○																																																																																																					
		<table border="1"> <thead> <tr> <th>Function code</th> <th>Binary bit</th> <th>Step</th> <th>ACC/DEC 1</th> <th>ACC/DEC 2</th> <th>ACC/DEC 3</th> <th>ACC/DEC 4</th> </tr> </thead> <tbody> <tr> <td rowspan="8">P10.34</td> <td>BIT1 BIT0</td> <td>0</td> <td>00</td> <td>01</td> <td>10</td> <td>11</td> </tr> <tr> <td>BIT3 BIT2</td> <td>1</td> <td>00</td> <td>01</td> <td>10</td> <td>11</td> </tr> <tr> <td>BIT5 BIT4</td> <td>2</td> <td>00</td> <td>01</td> <td>10</td> <td>11</td> </tr> <tr> <td>BIT7 BIT6</td> <td>3</td> <td>00</td> <td>01</td> <td>10</td> <td>11</td> </tr> <tr> <td>BIT9 BIT8</td> <td>4</td> <td>00</td> <td>01</td> <td>10</td> <td>11</td> </tr> <tr> <td>BIT11 BIT10</td> <td>5</td> <td>00</td> <td>01</td> <td>10</td> <td>11</td> </tr> <tr> <td>BIT13 BIT12</td> <td>6</td> <td>00</td> <td>01</td> <td>10</td> <td>11</td> </tr> <tr> <td>BIT15 BIT14</td> <td>7</td> <td>00</td> <td>01</td> <td>10</td> <td>11</td> </tr> <tr> <td rowspan="8">P10.35</td> <td>BIT1 BIT0</td> <td>8</td> <td>00</td> <td>01</td> <td>10</td> <td>11</td> </tr> <tr> <td>BIT3 BIT2</td> <td>9</td> <td>00</td> <td>01</td> <td>10</td> <td>11</td> </tr> <tr> <td>BIT5 BIT4</td> <td>10</td> <td>00</td> <td>01</td> <td>10</td> <td>11</td> </tr> <tr> <td>BIT7 BIT6</td> <td>11</td> <td>00</td> <td>01</td> <td>10</td> <td>11</td> </tr> <tr> <td>BIT9 BIT8</td> <td>12</td> <td>00</td> <td>01</td> <td>10</td> <td>11</td> </tr> <tr> <td>BIT11 BIT10</td> <td>13</td> <td>00</td> <td>01</td> <td>10</td> <td>11</td> </tr> <tr> <td>BIT13 BIT12</td> <td>14</td> <td>00</td> <td>01</td> <td>10</td> <td>11</td> </tr> <tr> <td>BIT15 BIT14</td> <td>15</td> <td>00</td> <td>01</td> <td>10</td> <td>11</td> </tr> </tbody> </table>			Function code	Binary bit	Step	ACC/DEC 1	ACC/DEC 2	ACC/DEC 3	ACC/DEC 4	P10.34	BIT1 BIT0	0	00	01	10	11	BIT3 BIT2	1	00	01	10	11	BIT5 BIT4	2	00	01	10	11	BIT7 BIT6	3	00	01	10	11	BIT9 BIT8	4	00	01	10	11	BIT11 BIT10	5	00	01	10	11	BIT13 BIT12	6	00	01	10	11	BIT15 BIT14	7	00	01	10	11	P10.35	BIT1 BIT0	8	00	01	10	11	BIT3 BIT2	9	00	01	10	11	BIT5 BIT4	10	00	01	10	11	BIT7 BIT6	11	00	01	10	11	BIT9 BIT8	12	00	01	10	11	BIT11 BIT10	13	00	01	10	11	BIT13 BIT12	14	00	01	10	11	BIT15 BIT14	15
Function code	Binary bit	Step	ACC/DEC 1	ACC/DEC 2	ACC/DEC 3	ACC/DEC 4																																																																																																			
P10.34	BIT1 BIT0	0	00	01	10	11																																																																																																			
	BIT3 BIT2	1	00	01	10	11																																																																																																			
	BIT5 BIT4	2	00	01	10	11																																																																																																			
	BIT7 BIT6	3	00	01	10	11																																																																																																			
	BIT9 BIT8	4	00	01	10	11																																																																																																			
	BIT11 BIT10	5	00	01	10	11																																																																																																			
	BIT13 BIT12	6	00	01	10	11																																																																																																			
	BIT15 BIT14	7	00	01	10	11																																																																																																			
P10.35	BIT1 BIT0	8	00	01	10	11																																																																																																			
	BIT3 BIT2	9	00	01	10	11																																																																																																			
	BIT5 BIT4	10	00	01	10	11																																																																																																			
	BIT7 BIT6	11	00	01	10	11																																																																																																			
	BIT9 BIT8	12	00	01	10	11																																																																																																			
	BIT11 BIT10	13	00	01	10	11																																																																																																			
	BIT13 BIT12	14	00	01	10	11																																																																																																			
	BIT15 BIT14	15	00	01	10	11																																																																																																			
P10.35	Simple PLC 8-15 step ACC/DEC time selection	Select corresponding ACC/DEC time, and then convert 16-bit binary number into decimal number, and then set corresponding function codes. Setting range: -0x0000-0xFFFF	0x0000	○																																																																																																					
P10.36	PLC restart mode	0: Restart from the first step, namely if the VFD stops during running (caused by stop command, fault or power down), it will run from the first step after restart. 1: Continue running from the step frequency when interruption occurred, namely if the VFD stops during running (caused by stop command or fault), it will record the running time of current step, and enters this step automatically after restart, then continue running at the frequency defined by this step in the remaining time.	0	◎																																																																																																					

Function code	Name	Description	Default	Modify
P10.37	Multi-step time unit selection	0: Second; the running time of each step is counted in seconds; 1: Minute; the running time of each step is counted in minutes	0	☉

P11 group Protection parameters

Function code	Name	Description	Default	Modify								
P11.00	Phase loss protection	0x000–0x111 Ones place: 0: Disable software input phase loss protection 1: Enable software input phase loss protection Tens place: 0: Disable output phase loss protection 1: Enable output phase loss protection Hundreds place: 0: Disable hardware input phase loss protection 1: Enable hardware input phase loss protection	010 (2.2kW and lower VFDs) 110 (4kW and higher VFDs)	○								
P11.01	Frequency drop at transient power-off	0: Enable 1: Disable	0	○								
P11.02	Frequency drop ratio at transient power-off	Setting range: 0.00Hz/s–P00.03 (max. output frequency) After the grid powers off, the bus voltage drops to the frequency drop point at transient power-off, the VFD begins to decrease the running frequency based on P11.02, to make the motor generate power again. The returning power can maintain the bus voltage to ensure a rated running of the VFD until the VFD is powered on again.	10.00 Hz/s	○								
		<table border="1"> <thead> <tr> <th>Voltage class</th> <th>220V</th> <th>380V</th> <th>660V</th> </tr> </thead> <tbody> <tr> <th>Frequency drop point at transient power-off</th> <td>240V</td> <td>460V</td> <td>800V</td> </tr> </tbody> </table>	Voltage class	220V	380V	660V	Frequency drop point at transient power-off	240V	460V	800V		
Voltage class	220V	380V	660V									
Frequency drop point at transient power-off	240V	460V	800V									

Function code	Name	Description	Default	Modify
		<p>Note:</p> <ol style="list-style-type: none"> 1. Adjust the parameter properly to avoid the stopping caused by VFD protection during the switching of the grid. 2. Disable the input phase loss protection before enabling this function. 		
P11.03	Overvoltage stall protection	<p>0: Disable 1: Enable</p>	1	○
P11.04	Overvoltage stall protection voltage	110–150% (standard bus voltage) (380V)	130%	○
		110–150% (standard bus voltage) (220V)	120%	
P11.05	Current limit action	<p>During the accelerating operation of the VFD, due to the large load, actual rising rate of the motor rotating speed is lower than rising rate of the output frequency. Measures shall be taken to avoid VFD tripping caused by overcurrent during acceleration.</p> <p>0x00–0x11 Ones place: Current limit action setting 0: Invalid 1: Always valid Tens place: Hardware current limit overload alarm setting 0: Valid 1: Invalid</p>	0x01	◎
P11.06	Automatic current limit level	Current limit protection function detects output current during running, and compares it with the current-limit level defined by	160.0%	◎

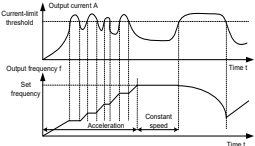
Function code	Name	Description	Default	Modify
P11.07	Frequency drop rate during current limit	<p>P11.06, if it exceeds the current-limit level, the VFD will run at stable frequency during accelerated running, or run in decreased frequency during constant-speed running; if it exceeds the current-limit level continuously, the VFD output frequency will drop continuously until reaching lower limit frequency. When the output current is detected to be lower than the current-limit level again, it will continue accelerated running.</p>  <p>Setting range of P11.06: 50.0–200.0% (relative to the percentage of rated current of the VFD) Setting range of P11.07: 0.00–50.00Hz/s</p>	10.00 Hz/s	⊙
P11.08	Pre-alarm selection for VFD/motor OL/UL	<p>0x0000–0x1132 Ones place: 0: Motor overload/underload pre-alarm, relative to rated motor current; 1: VFD overload/underload pre-alarm, relative to rated VFD current. 2: Motor output torque overload/underload pre-alarm, relative to rated motor torque Tens place: 0: The VFD continues running after overload/underload alarm; 1: The VFD continues running after underload alarm, and stops running after overload fault; 2: The VFD continues running after overload alarm, and stops running after underload fault;</p>	0x0000	○

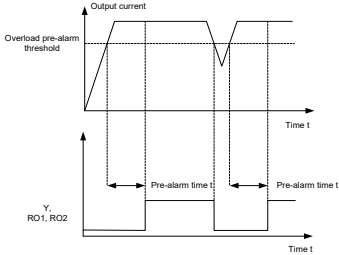
Function code	Name	Description	Default	Modify
		3: The VFD stops running after overload/underload fault. Hundreds place: 0: Always detect 1: Detect during constant-speed running Thousands place: Overload integral function selection 0: Overload integral is invalid; 1: Overload integral is valid.		
P11.09	Overload pre-alarm detection level	Overload pre-alarm signal will be outputted if the output current of the VFD or motor is higher than overload pre-alarm detection level (P11.09), and the duration exceeds overload pre-alarm detection time (P11.10).	150%	○
P11.10	Overload pre-alarm detection time	 <p>Setting range of P11.09: P11.11–200% (relative value determined by ones place of P11.08) Setting range of P11.10: 0.1–3600.0s</p>	1.0s	○
P11.11	Underload pre-alarm detection level	Underload pre-alarm signal will be outputted if the output current of the VFD or motor is lower than underload pre-alarm detection level (P11.11), and the duration exceeds underload pre-alarm detection time (P11.12).	50%	○
P11.12	Underload pre-alarm detection time	Setting range of P11.11: 0–P11.09 (relative value determined by ones place of P11.08) Setting range of P11.12: 0.1–3600.0s	1.0s	○

Function code	Name	Description	Default	Modify
P11.13	Fault output terminal action upon fault occurring	The function code is used to set the action of fault output terminals at undervoltage and fault reset. 0x00–0x11 Ones place: 0: Act at undervoltage 1: Do not act at undervoltage Tens place: 0: Act at fault reset 1: Do not act at fault reset	0x00	○
P11.16	Extension function selection	0x00–0x11 Ones place: Automatic frequency drop selection at voltage drop 0: Disable 1: Enable Tens place: Second ACC/DEC time selection 0: Disable 1: Enable. When the running frequency exceeds P08.36 , ACC/DEC time is switched to the second ACC/DEC time.	0x00	○

P13 group SM control

Function code	Name	Description	Default	Modify
P13.09	Frequency threshold of phase-lock loop switch-in	0.00–630.00	50.00	○
P13.13	Short-circuit braking current	When the VFD starts in direct start mode (P01.00 =0), set P13.14 to a non-zero value to enter short-circuit braking.	0.0%	○
P13.14	Hold time of short-circuit braking for start	During stop, if the running frequency of VFD is lower than the starting frequency P01.09 of brake for stop, set P13.15 to a non-zero value to enter short-circuit braking for stop, and then carry out DC braking in the time set by P01.12 . (Refer	0.00s	○
P13.15	Hold time of short-circuit		0.00s	○

Function code	Name	Description	Default	Modify
	braking for stop	to the descriptions for P01.09–P01.12.) Setting range of P13.13 : 0.0–150.0% (relative to the percentage of rated current of the VFD) Setting range of P13.14 : 0.00–50.00s Setting range of P13.15 : 0.00–50.00s		

P14 group Serial communication

Function code	Name	Description	Default	Modify
P14.00	Local communication address	Setting range: 1–247 When the master writes the slave communication address to 0 indicating a broadcast address in a frame, all the slaves on the Modbus bus receive the frame but do not respond to it. Local communication address is unique in the communication network, which is the basis for point-to-point communication between the upper computer and the VFD. Note: The communication address of a slave cannot be set to 0.	1	○
P14.01	Communication baud rate	The function code is used to set the data transmission speed between upper computer and the VFD. 0: 1200BPS 1: 2400BPS 2: 4800BPS 3: 9600BPS 4: 19200BPS 5: 38400BPS 6: 57600BPS Note: The baud rate set on the VFD must be consistent with that on the upper computer. Otherwise, the communication fails. A greater baud rate indicates faster communication.	4	○

Function code	Name	Description	Default	Modify
P14.02	Data bit check	<p>The data format set on the VFD must be consistent with that on the upper computer. Otherwise, the communication fails.</p> <p>0: No check (N, 8, 1) for RTU 1: Even check (E, 8, 1) for RTU 2: Odd check (O, 8, 1) for RTU 3: No check (N, 8, 2) for RTU 4: Even check (E, 8, 2) for RTU 5: Odd check (O, 8, 2) for RTU 6: No check (N, 7, 1) for ASCII 7: Even check (E, 7, 1) for ASCII 8: Odd check (O, 7, 1) for ASCII 9: No check (N, 7, 2) for ASCII 10: Even check (E, 7, 2) for ASCII 11: Odd check (O, 7, 2) for ASCII 12: No check (N, 8, 1) for ASCII 13: Even check (E, 8, 1) for ASCII 14: Odd check (O, 8, 1) for ASCII 15: No check (N, 8, 2) for ASCII 16: Even check (E, 8, 2) for ASCII 17: Odd check (O, 8, 2) for ASCII</p>	1	○
P14.03	Communication response delay	<p>0–200ms</p> <p>The function code indicates the communication response delay, that is, the interval from when the VFD completes receiving data to when it sends response data to the upper computer. If the response delay is shorter than the VFD processing time, the VFD sends response data to the upper computer after processing data. If the delay is longer than the VFD processing time, the VFD does not send response data to the upper computer until the delay is reached although data has been processed.</p>	5	○
P14.04	RS485 communication timeout period	<p>0.0 (invalid)–60.0s</p> <p>When the function code is set to 0.0, the communication timeout time is invalid.</p>	0.0s	○

Function code	Name	Description	Default	Modify
		When the function code is set a non-zero value, the rectifier reports the "485 communication fault" (CE) if the communication interval exceeds the value. In general, the function code is set to 0.0. When continuous communication is required, you can set the function code to monitor communication status.		
P14.05	Transmission error processing	0: Report an alarm and coast to stop 1: Keep running without reporting an alarm 2: Stop in enabled stop mode without reporting an alarm (applicable only to communication mode) 3: Stop in enabled stop mode without reporting an alarm (applicable to any mode)	0	○
P14.06	Communication processing action	0x00–0x11 Ones place: 0: Respond to write operations. The VFD responds to read and write commands of the upper computer. 1: Not respond to write operations. The VFD responds only to the read commands of the upper computer. This mode can improve the communication efficiency. Tens place: Communication encryption 0: Communication password protection is invalid 1: Communication password protection is valid Hundreds place: User-defined communication command address 0: User-defined addresses specified by P14.07 and P14.08 are invalid 1: User-defined addresses specified by P14.07 and P14.08 are valid	0x000	○

Function code	Name	Description	Default	Modify
P14.07	Self-defined address of the running command	0x0000–0xffff	0x1000	○
P14.08	Self-defined address of frequency setting	0x0000–0xffff	0x2000	○

P17 group Status viewing

Function code	Name	Description	Default	Modify
P17.00	Set frequency	Displays current set frequency of the VFD. Range: 0.00Hz– P00.03	0.00Hz	●
P17.01	Output frequency	Displays current output frequency of the VFD. Range: 0.00Hz– P00.03	0.00Hz	●
P17.02	Ramp reference frequency	Displays current ramp reference frequency of the VFD. Range: 0.00Hz– P00.03	0.00Hz	●
P17.03	Output voltage	Displays current output voltage of the VFD. Range: 0–1200V	0V	●
P17.04	Output current	Displays the valid value of present output current of the VFD. Range: 0.0–5000.0A	0.0A	●
P17.05	Motor speed	Displays current motor speed. Range: 0–65535RPM	0 RPM	●
P17.06	Torque current	Displays current torque current of the VFD. Range: 0.0–5000.0A	0.0A	●
P17.07	Exciting current	Displays current exciting current of the VFD. Range: 0.0–5000.0A	0.0A	●
P17.08	Motor power	Displays current motor power; 100% relative to rated motor power, positive value is motoring state, negative value is generating state.	0.0A	●

Function code	Name	Description	Default	Modify
		Setting range: -300.0%–300.0% (relative to rated motor power)		
P17.09	Output torque	Displays current output torque of the VFD; 100% relative to rated motor torque, positive value is motoring state, negative value is generating state. Range: -250.0–250.0%	0.0%	●
P17.10	Estimated motor frequency	Displays the estimated motor rotor frequency under open-loop vector condition. Range: 0.00– P00.03	0.00Hz	●
P17.11	DC bus voltage	Displays current DC bus voltage of the VFD Range: 0.0–2000.0V	0.0V	●
P17.12	Digital input terminal state	Displays current digital input terminal state of the VFD. Range: 0x0000–0x00FF	0x0000	●
P17.13	Digital output terminal state	Displays current digital output terminal state of the VFD. Range: 0x0000–0x00FF	0x0000	●
P17.14	Digital adjustment value	Displays the regulating variable of keypad. Range : 0.00Hz– P00.03	0.00Hz	●
P17.15	Torque reference value	Relative to percentage of the rated torque of current motor, display torque reference. Setting range: -300.0%–300.0% (of the rated motor current)	0.0%	●
P17.16	Linear speed	Display current linear speed of the VFD. Range: 0–65535	0	●
P17.17	Reserved			●
P17.18	Counting value	Displays current counting value of the VFD. Range: 0–65535	0	●
P17.19	AI1 input voltage	Displays input signal of AI1. Range: 0.00–10.00V	0.00V	●
P17.20	AI2 input voltage	Displays input signal of AI2. Range: 0.00–10.00V	0.00V	●

Function code	Name	Description	Default	Modify
P17.21	AI3 input voltage	Displays input signal of AI3. Range: -10.00–10.00V	0.00V	●
P17.22	HDI input frequency	Displays input frequency of HDI. Range: 0.000–50.000kHz	0.000kHz	●
P17.23	PID reference value	Displays PID reference value. Range: -100.0–100.0%	0.0%	●
P17.24	PID feedback value	Displays PID feedback value. Range: -100.0–100.0%	0.0%	●
P17.25	Motor power factor	Displays the power factor of current motor. Range: -1.00–1.00	0.00	●
P17.26	Time elapsed of this run	Displays the time elapsed of this run. Range: 0–65535 min	0m	●
P17.27	Simple PLC and current step number of multi-step speed	Display simple PLC and current step number of multi-step speed Range: 0–15	0	●
P17.28	ASR controller output	Displays the speed loop ASR controller output value under vector control mode, relative to the percentage of rated torque of the motor. Range: -300.0%–300.0% (rated motor current)	0.0%	●
P17.29– P17.31	Reserved			
P17.32	Motor flux linkage	Displays flux linkage value of the motor. Range: 0.0%–200.0%	0.0%	●
P17.33	Exciting current reference	Displays the exciting current reference value under vector control mode. Range: -3000.0–+3000.0A	0.0A	●
P17.34	Torque current reference	Displays torque current reference value under vector control mode. Range: -3000.0–+3000.0A	0.0A	●
P17.35	AC incoming current	Displays the valid value of incoming current on AC side. Range: 0.0–5000.0A	0.0A	●
P17.36	Output torque	Displays output torque value, positive value is motoring state, and negative	0.0Nm	●

Function code	Name	Description	Default	Modify
		value is generating state. Range: -3000.0 Nm–3000.0 Nm		
P17.37	Motor overload count value	0–100 (Display the "OL1" fault when the count value is 100)	0	●
P17.38	PID output value	Displays PID output value. Range: -100.0–100.0%	0.0%	●
P17.39	Function code in parameter download error	0.00–99.99	0.00	●
P17.40	Process PID proportional gain	0.00–100.00	0.00	●
P17.41	Process PID integral time	0.00–10.00s	0.00s	●
P17.42	Process PID differential time	0.00–10.00s	0.00s	●

Chapter 6 Fault tracking

6.1 Fault prevention

This chapter describes how to carry out preventive maintenance on VFDs.

6.1.1 Periodical maintenance

If the VFD is installed in an environment that meets requirements, little maintenance is needed. The following table describes the routine maintenance periods recommended by INVT. For more detailed information on maintenance, please contact us.

Checking part		Checking item	Checking method	Criterion
Ambient environment		Check the ambient temperature, humidity and vibration and ensure there is no dust, gas, oil fog and water drop.	Visual examination and instrument test	Conforming to the manual
		Ensure there are no tools or other foreign or dangerous objects	Visual examination	There are no tools or dangerous objects.
Voltage		Ensure the main circuit and control circuit are normal.	Measurement by multimeter.	Conforming to the manual
Keypad		Ensure the display is clear enough	Visual examination	The characters are displayed normally.
		Ensure the characters are displayed totally	Visual examination	Conforming to the manual
Main circuit	For public use	Ensure the screws are tightened scurrility	Tighten up	NA
		Ensure there is no distortion, crackles, damage or color-changing caused by overheating and aging to the machine and insulator.	Visual examination	NA
		Ensure there is no dust and dirtiness	Visual examination	NA Note: if the color of the copper aluminum

Checking part	Checking item	Checking method	Criterion
			blocks change, it does not mean that there is something wrong with the features.
The lead of the conductors	Ensure that there is no distortion or color-changing of the conductors caused by overheating.	Visual examination	NA
	Ensure that there are no crackles or color-changing of the protective layers.	Visual examination	NA
Terminals seat	Ensure that there is no damage	Visual examination	NA
Filter capacitors	Ensure that there is no weeping, color-changing, crackles and cassis expansion.	Visual examination	NA
	Ensure the safety valve is in the right place.	Estimate the usage time according to the maintenance or measure the static capacity.	NA
	If necessary, measure the static capacity.	Measure the capacity by instruments.	The static capacity is above or equal to the original value x0.85.
Resistors	Ensure whether there is replacement and splitting caused by overheating.	Smelling and visual examination	NA
	Ensure that there is no offline.	Visual examination or remove one ending to	The resistors are in $\pm 10\%$ of the standard value.

Checking part		Checking item	Checking method	Criterion
	Transformers and reactors		coagulate or measure with multimeters	
		Ensure there is no abnormal vibration, noise and smelling,	Hearing, smelling and visual examination	NA
	Electromagnetism contactors and relays	Ensure whether there is vibration noise in the workrooms.	Hearing	NA
		Ensure the contactor is good enough.	Visual examination	NA
Control circuit	PCB and plugs	Ensure there are no loose screws and contactors.	Fasten up	NA
		Ensure there is no smelling and color-changing.	Smelling and visual examination	NA
		Ensure there are no crackles, damage distortion and rust.	Visual examination	NA
		Ensure there is no weeping and distortion to the capacitors.	Visual examination or estimate the usage time according to the maintenance information	NA
Cooling system	Cooling fan	Estimate whether there is abnormal noise and vibration.	Hearing and Visual examination or rotate with hand	Stable rotation
		Estimate there is no losses screw.	Tighten up	NA
		Ensure there is no color-changing caused by overheating.	Visual examination or estimate the usage time according to the	NA

Checking part		Checking item	Checking method	Criterion
			maintenance information	
	Ventilating duct	Ensure whether there is stuff or foreign objection in the cooling fan, air vent.	Visual examination	NA

6.1.2 Cooling fan

The VFD's cooling fan has a minimum life span of 25,000 operating hours. The actual life span depends on the VFD usage and ambient temperature. The operating hours can be found through [P07.14](#) (accumulative hours of the VFD).

Fan failure can be predicted by the increasing noise from the fan bearings. If the VFD is operated in a critical part of a process, fan replacement is recommended once these symptoms appear. Replacement fans are available from INVT.

	<p>◇ Read and follow the instructions in Chapter 1 "Safety precautions". Ignoring the instructions would cause physical injury or death, or damage to the equipment.</p>
--	--

1. Stop the VFD and disconnect it from the AC power source and wait for at least the time designated on the VFD.
2. Lever the fan holder off the drive frame with a screwdriver and lift the hinged fan holder slightly upward from its front edge.
3. Disconnect the fan cable. Remove the installation bracket.
4. Install the bracket to the reversed direction. Pay attention the air direction of the VFD and the fan, as shown in the following figure.

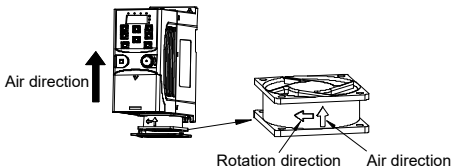

Figure 6-1 Fan installation of the VFDs 1PH, 220V, ≤2.2kW

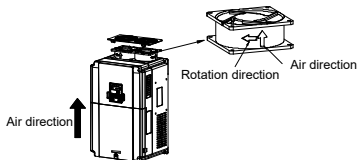

Figure 6-2 Fan installation of the VFDs 3PH, 380V, ≥4kW

5. Power on the VFD.

6.1.3 Capacitor

6.1.3.1 Capacitor reforming

If the VFD has been left unused for a long time, you need to follow the instructions to reform the DC bus capacitor before using it. The storage time is calculated from the date the VFD is delivered.

Storage time	Operation instruction
Less than 1 year	No charging operation is required.
1 to 2 years	The VFD needs to be powered on for 1 hour before the first running command.
2 to 3 years	Use a voltage controlled power supply to charge the VFD: Charge the VFD at 25% of the rated voltage for 30 minutes, and then charge it at 50% of the rated voltage for 30 minutes, at 75% for another 30 minutes, and finally charge it at 100% of the rated voltage for 30 minutes.
More than 3 years	Use a voltage controlled power supply to charge the VFD: Charge the VFD at 25% of the rated voltage for 2 hours, and then charge it at 50% of the rated voltage for 2 hours, at 75% for another 2 hours, and finally charge it at 100% of the rated voltage for 2 hours.

The method for using a voltage controlled power supply to charge the VFD is described as follows:

The selection of a voltage controlled power supply depends on the power supply of the VFD. For VFDs with an incoming voltage of 1PH/3PH 220V AC, you can use a 220VAC/2A voltage regulator. Both 1PH and 3PH VFDs can be charged with a 1PH voltage controlled power supply (connect L+ to R, and N to S or T). All the DC bus capacitors share one rectifier, and therefore they are all charged.

For VFDs of a high voltage class, ensure that the voltage requirement (for example, 380 V) is met during charging. Capacitor charging requires little current, and therefore you can use a small-capacity power supply (2A is sufficient).

6.1.3.2 Electrolytic capacitor replacement



- ✧ Read and follow the instructions in Chapter 1 "Safety precautions". Ignoring the instructions may cause physical injury or death, or damage to the equipment.

The electrolytic capacitor of the VFD must be replaced if it has been used for more than 35,000 hours. For details about the replacement, contact the local INVT office or dial our national service hotline (400-700-9997).

6.1.4 Power cable



- ✧ Read and follow the instructions in Chapter 1 "Safety precautions". Ignoring the instructions may cause physical injury or death, or damage to the equipment.

1. Stop the drive and disconnect it from the power line. Wait for at least the time designated on the VFD.

2. Check the tightness of the power cable connections.

3. Restore power.

6.2 Fault handling



- ✧ Only qualified electricians are allowed to maintain the VFD. Read the safety instructions in Chapter 1 "Safety precautions" before working on the VFD.

6.2.1 Indications of alarms and faults

Faults are indicated by indicators. For details, see Chapter 4 "Keypad operation". When the **TRIP** indicator is on, the alarm or fault code displayed on the keypad indicates that an exception occurs on the VFD. The function codes [P07.27](#) to [P07.32](#) record the types of the last six faults. The function codes [P07.33](#) to [P07.40](#), [P07.41](#) to [P07.48](#), and [P07.49](#) to [P07.56](#) record the running data of the VFD at the last three faults, respectively. You can find out causes and solutions for most of the alarms or faults based on the information provided in this chapter. If you cannot find out the causes of an alarm or fault, contact the local INVT office.

6.2.2 Fault reset

The VFD can be reset by pressing the keypad key **STOP/RST**, through digital input, or by switching the power light. When the fault has been removed, the motor can be restarted.

6.2.3 VFD faults and solutions

When a fault occurred, handle the fault as follows.

1. Check to ensure there is nothing wrong with the keypad. If not, please contact the local INVT office.

2. If there is nothing wrong, please check P07 and ensure the corresponding recorded fault parameters to confirm the real state when the current fault occurs by all parameters.

3. See the following table for detailed solution and check the corresponding abnormal state.
4. Eliminate the fault and ask for related help.
5. Check to eliminate the fault and carry out fault reset to run the VFD.

Note: The numbers enclosed in square brackets such as [1], [2] and [3] in the Fault type column in the following table indicate the VFD fault type codes read through communication.

Fault code	Fault type	Possible cause	Solutions
OUt1	[1] Inverter unit U phase protection	<ul style="list-style-type: none"> ● The acceleration is too fast; ● IGBT module fault; ● Misacts caused by interference; ● The connection of the driving wires is not good; ● Grounding is not properly. 	<ul style="list-style-type: none"> ● Increase ACC time; ● Change the power unit; ● Check the driving wires; ● Inspect external equipment and eliminate interference.
OUt2	[2] Inverter unit V phase protection		
OUt3	[3] Inverter unit W phase protection		
OC1	[4] Overcurrent during acceleration	<ul style="list-style-type: none"> ● The acceleration or deceleration is too fast; ● The voltage of the grid is too low; ● The power of the VFD is too low; ● The load transients or is abnormal; ● The grounding is short circuited or the output is phase loss; ● There is strong external interference; ● The overvoltage stall protection is not open. 	<ul style="list-style-type: none"> ● Increase the ACC time; ● Check the input power; ● Select the VFD with a larger power; ● Check if the load is short circuited (the grounding short circuited or the wire short circuited) or the rotation is not smooth; ● Check the output configuration; ● Check if there is strong interference; ● Check the setting of related function codes.
OC2	[5] Overcurrent during deceleration		
OC3	[6] Overcurrent during constant speed running		
OV1	[7] Overvoltage during acceleration	<ul style="list-style-type: none"> ● The input voltage is abnormal; ● There is large energy feedback; ● No braking components; ● Braking energy is not open. 	<ul style="list-style-type: none"> ● Check the input power; ● Check if the DEC time of the load is too short or the VFD starts during the rotation of the motor or it needs to increase the energy consumption components;
OV2	[8] Overvoltage during deceleration		
OV3	[9] Overvoltage during constant speed running		

Fault code	Fault type	Possible cause	Solutions
			<ul style="list-style-type: none"> ● Install the braking components; ● Check the setting of related function codes.
UV	[10] Bus undervoltage	<ul style="list-style-type: none"> ● The voltage of the power supply is too low. 	<ul style="list-style-type: none"> ● Check the input power of the supply line.
OL1	[11] Motor overload	<ul style="list-style-type: none"> ● The voltage of the power supply is too low; ● The motor setting rated current is incorrect; ● The motor stall or load transients is too strong. 	<ul style="list-style-type: none"> ● Check the power of the supply line; ● Reset the rated current of the motor; ● Check the load and adjust the torque lift.
OL2	[12] VFD overload	<ul style="list-style-type: none"> ● The acceleration is too fast; ● Reset the rotating motor; ● The voltage of the power supply is too low; ● The load is too heavy; ● The motor power is too large, and the power of the VFD is too small. 	<ul style="list-style-type: none"> ● Increase the ACC time; ● Avoid the restarting after stopping; ● Check the power of the supply line; ● Select a VFD with bigger power; ● Select a proper motor.
SPI	[13] Phase loss on input side	<ul style="list-style-type: none"> ● Phase loss or violent fluctuation occurred to R, S, and T input. 	<ul style="list-style-type: none"> ● Check input power; ● Check installation distribution.
SPO	[14] Phase loss on output side	<ul style="list-style-type: none"> ● Phase loss occurred to U, V, W output (or the three phases of motor is asymmetrical) 	<ul style="list-style-type: none"> ● Check the output distribution; ● Check the motor and cable.
OH1	[15] Rectifier module overheat	<ul style="list-style-type: none"> ● Air duct jam or fan damage; ● Ambient temperature is too high; ● The time of overload running is too long. 	<ul style="list-style-type: none"> ● Dredge the vent duct or replace the fan; ● Lower the ambient temperature.
OH2	[16] Inverter module overheat		
EF	[17] External fault	<ul style="list-style-type: none"> ● SI external fault input terminals action 	<ul style="list-style-type: none"> ● Check the external device input

Fault code	Fault type	Possible cause	Solutions
CE	[18] 485 communication fault	<ul style="list-style-type: none"> ● The baud rate setting is incorrect; ● Fault occurs to the communication wiring; ● The communication address is wrong; ● There is strong interference to the communication. 	<ul style="list-style-type: none"> ● Set proper baud rate; ● Check the communication connection distribution; ● Set proper communication address; ● Change or replace the connection distribution or improve the anti-interference capability.
ItE	[19] Current detection fault	<ul style="list-style-type: none"> ● The control panel connector is in poor contact; ● An exception occurs on the magnifying circuit. 	<ul style="list-style-type: none"> ● Check the connector and re-plug ● Change the main control panel
tE	[20] Motor autotuning fault	<ul style="list-style-type: none"> ● The motor capacity does not comply with the VFD capability; ● The rated parameter of the motor does not set correctly; ● The offset between the parameters from autotuning and the standard parameter is huge; ● Autotuning overtime. 	<ul style="list-style-type: none"> ● Change the VFD mode; ● Set the rated parameter according to the motor name plate; ● Empty the motor load; ● Check the motor connection and set the parameter; ● Check if the upper limit frequency is above 2/3 of the rated frequency.
EEP	[21] EEPROM operation fault	<ul style="list-style-type: none"> ● Error of controlling the write and read of the parameters; ● Damage to EEPROM. 	<ul style="list-style-type: none"> ● Press STOP/RST to reset; ● Change the main control panel.
PIDE	[22] PID feedback offline fault	<ul style="list-style-type: none"> ● PID feedback offline; ● PID feedback source disappear. 	<ul style="list-style-type: none"> ● Check the PID feedback signal; ● Check the PID feedback source.
bCE	[23] Braking unit fault	<ul style="list-style-type: none"> ● Braking circuit fault or damage to the braking pipes; 	<ul style="list-style-type: none"> ● Check the braking unit, and change new braking pipe;

Fault code	Fault type	Possible cause	Solutions
		<ul style="list-style-type: none"> ● The external braking resistor is not sufficient. 	<ul style="list-style-type: none"> ● Increase the braking resistor.
END	[24] Running time reached	<ul style="list-style-type: none"> ● The actual running time of the VFD is above the internal setting running time. 	<ul style="list-style-type: none"> ● Ask for the supplier and adjust the setting running time.
OL3	[25] Electronic overload	<ul style="list-style-type: none"> ● The VFD will report overload pre-alarm according to the set value. 	<ul style="list-style-type: none"> ● Check the load and the overload pre-alarm threshold.
PCE	[26] Keypad communication error	<ul style="list-style-type: none"> ● The keypad is not in good connection or offline; ● The keypad cable is too long and there is strong interference; ● Part of the communication circuits of the keypad or main board have fault. 	<ul style="list-style-type: none"> ● Check the keypad cable and ensure it is normal; ● Check the environment and eliminate the interference source; ● Change hardware and ask for maintenance service.
UPE	[27] Parameter upload error	<ul style="list-style-type: none"> ● The keypad is not in good connection or offline; ● The keypad cable is too long and there is strong interference; ● Part of the communication circuits of the keypad or main board have fault. 	<ul style="list-style-type: none"> ● Check the environment and eliminate the interference source; ● Change hardware and ask for maintenance service; ● Change hardware and ask for maintenance service.
DNE	[28] Parameter download error	<ul style="list-style-type: none"> ● The keypad is not in good connection or offline; ● The keypad cable is too long and there is strong interference; ● Data storage error in keypad. 	<ul style="list-style-type: none"> ● Check the environment and eliminate the interference source; ● Change hardware and ask for maintenance service; ● Back up data in the keypad again.

Fault code	Fault type	Possible cause	Solutions
ETH1	[32] To-ground short-circuit fault 1	<ul style="list-style-type: none"> ● The output of the VFD is short circuited with the ground; ● There is fault in the current detection circuit; ● There is a great difference between the actual motor power setting and the VFD power. 	<ul style="list-style-type: none"> ● Check if the connection of the motor is normal or not; ● Change the hall; ● Change the main control panel; ● Reset the correct motor parameter; ● Check whether motor power parameters in P2 group is consistent with the motor power actually used.
ETH2	[33] To-ground short-circuit fault 2		
dEu	[34] Speed deviation fault	<ul style="list-style-type: none"> ● Load is too heavy, or stall occurred. 	<ul style="list-style-type: none"> ● Check the load to ensure it is proper, increase the detection time. ● Check whether control parameters are set properly.
STo	[35] Maladjustment fault	<ul style="list-style-type: none"> ● Control parameters of synchronous motor are set improperly. ● The parameter gained from autotuning is inaccurate. ● The VFD is not connected to motor. 	<ul style="list-style-type: none"> ● Check the load to ensure it is proper. ● Check whether control parameters are set correctly. ● Increase maladjustment detection time.
LL	[36] Electronic underload fault	<ul style="list-style-type: none"> ● The VFD will report the underload pre-alarm according to the set value. 	<ul style="list-style-type: none"> ● Check the load and the underload pre-alarm point.

6.2.4 Other states

Fault code	Fault type	Possible cause	Solutions
PoFF	System power off	System power off or low DC voltage	Check the grid

Chapter 7 Communication protocol

7.1 Brief instruction to Modbus protocol

Modbus protocol is a software protocol and common language which is applied in the electrical controller. With this protocol, the controller can communicate with other devices via network (the channel of signal transmission or the physical layer, such as RS485). And with this industrial standard, the controlling devices of different manufacturers can be connected to an industrial network for the convenient of being monitored.

There are two transmission modes for Modbus protocol: ASCII mode and RTU (Remote Terminal Units) mode. On one Modbus network, all devices should select same transmission mode and their basic parameters, such as baud rate, digital bit, check bit, and stopping bit should have no difference.

Modbus network is a controlling network with single-master and multiple slaves, which means that there is only one device performs as the master and the others are the slaves on one Modbus network. The master means the device which has active talking right to send message to Modbus network for the controlling and inquiring to other devices. The slave means the passive device which sends data message to the Modbus network only after receiving the controlling or inquiring message (command) from the master (response). After the master sends message, there is a period of time left for the controlled or inquired slaves to response, which ensure there is only one slave sends message to the master at a time for the avoidance of singles impact.

Generally, the user can set PC, PLC, IPC and HMI as the masters to realize central control. Setting certain device as the master is a promise other than setting by a bottom or a switch or the device has a special message format. For example, when the upper monitor is running, if the operator clicks sending command bottom, the upper monitor can send command message actively even it cannot receive the message from other devices. In this case, the upper monitor is the master. And if the designer makes the VFD send the data only after receiving the command, then the VFD is the slave.

The master can communicate with any single slave or with all slaves. For the single-visiting command, the slave should feedback a response message; for the broadcasting message from the master, the slave does not need to feedback the response message.

7.2 Application of the VFD

The VFD uses the Modbus RTU mode and the physical layer is 2-wire RS485.

7.2.1 2-wire RS485

2-wire RS485 interfaces works in half-duplex mode and send data signals in the differential transmission way, which is also referred to as balanced transmission. An RS485 interface

uses a twisted pair, in which one wire is defined as A (+), and the other B (-). Generally, if the positive electrical level between the transmission drives A and B ranges from +2 V to +6 V, the logic is "1"; and if it ranges from -2 V to -6 V, the logic is "0".

On the VFD terminal block, the 485+ terminal corresponds to A, and 485- corresponds to B.

The communication baud rate (P14.01) indicates the number of bits sent in a second, and the unit is bit/s (bps). A higher baud rate indicates faster transmission and poorer anti-interference capability. When a twisted pair of 0.56mm (24 AWG) is used, the maximum transmission distance varies according to the baud rate, as described in the following table.

Baud rate	Max. transmission distance	Baud rate	Max. transmission distance	Baud rate	Max. transmission distance	Baud rate	Max. transmission distance
2400 BPS	1800m	4800 BPS	1200m	9600 BPS	800m	19200 BPS	600m

When RS485 interfaces are used for long-distance communication, it is recommended that you use shielded cables, and use the shielding layer as the ground wires.

When there are fewer devices and the transmission distance is short, the whole network works well without terminal load resistors. The performance, however, degrades as the distance increases. Therefore, it is recommended that you use a 120Ω terminal resistor when the transmission distance is long.

7.2.1.1 When one VFD is used

Figure 7-1 is the Modbus wiring diagram for the network with one VFD and PC. Generally, PCs do not provide RS485 interfaces, and therefore you need to convert an RS232 or USB interface of a PC to an RS485 interface through a converter. Then, connect end A of the RS485 interface to the 485+ port on the terminal block of the VFD, and connect end B to the 485- port. It is recommended that you use shielded twisted pairs. When an RS232-RS485 converter is used, the cable used to connect the RS232 interface of the PC and the converter cannot be longer than 15 m. Use a short cable when possible. It is recommended that you insert the converter directly into the PC. Similarly, when a USB-RS485 converter is used, use a short cable when possible.

When the wiring is completed, select the correct port (for example, COM1 to connect to the RS232-RS485 converter) for the upper computer of the PC, and keep the settings of basic parameters such as communication baud rate and data check bit consistent with those of the VFD.

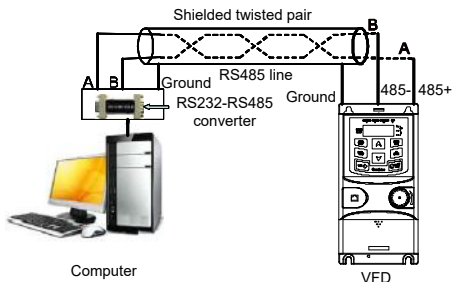

Figure 7-1 RS485 wiring diagram for the network with one VFD

7.2.1.2 When multiple VFDs are used

In the network with multiple VFDs, chrysanthemum connection and star connection are commonly used. According to the requirements of the RS485 industrial bus standards, all the devices need to be connected in chrysanthemum mode with one 120 Ω terminal resistor on each end, as shown in Figure 7-2.

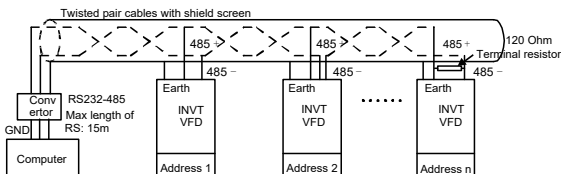

Figure 7-2 Practical application diagram of chrysanthemum connection

Figure 7-3 shows the start connection diagram. When this connection mode is adopted, the two devices that are farthest away from each other on the line must be connected with a terminal resistor (in this figure, the two devices are devices 1# and 15#).

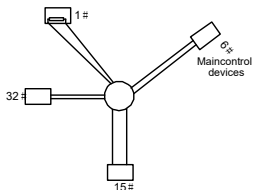

Figure 7-3 Star connection

Use shielded cables, if possible, in multi-VFD connection. The baud rates, data bit check settings, and other basic parameters of all the devices on the RS485 line must be set consistently, and addresses cannot be repeated.

7.2.2 RTU mode

7.2.2.1 RTU communication frame structure

When a controller is set to use the RTU communication mode on a Modbus network, every byte (8 bits) in the message includes 2 hexadecimal characters (each includes 4 bits). Compared with the ASCII mode, the RTU mode can transmit more data with the same baud rate.

Code system

- 1 start bit
- 7 or 8 data bits; the minimum valid bit is transmitted first. Each frame domain of 8 bits includes 2 hexadecimal characters (0–9, A–F).
- 1 odd/even check bit; this bit is not provided if no check is needed.
- 1 stop bit (with check performed), or 2 bits (without check)

Error detection domain

- Cyclic redundancy check (CRC)

The following table describes the data format.

11-bit character frame (Bits 1 to 8 are data bits)

Start bit	BIT1	BIT2	BIT3	BIT4	BIT5	BIT6	BIT7	BIT8	Check bit	Stop bit
-----------	------	------	------	------	------	------	------	------	-----------	----------

10-bit character frame (Bits 1 to 7 are data bits)

Start bit	BIT1	BIT2	BIT3	BIT4	BIT5	BIT6	BIT7	Check bit	Stop bit
-----------	------	------	------	------	------	------	------	-----------	----------

In a character frame, only the data bits carry information. The start bit, check bit, and stop bit are used to facilitate the transmission of the data bits to the destination device. In practical

applications, you must set the data bits, parity check bits, and stop bits consistently.

In RTU mode, the transmission of a new frame always starts from an idle time (the transmission time of 3.5 bytes). On a network where the transmission rate is calculated based on the baud rate, the transmission time of 3.5 bytes can be easily obtained. After the idle time ends, the data domains are transmitted in the following sequence: slave address, operation command code, data, and CRC check character. Each byte transmitted in each domain includes 2 hexadecimal characters (0–9, A–F). The network devices always monitor the communication bus. After receiving the first domain (address information), each network device identifies the byte. After the last byte is transmitted, a similar transmission interval (the transmission time of 3.5 bytes) is used to indicate that the transmission of the frame ends. Then, the transmission of a new frame starts.

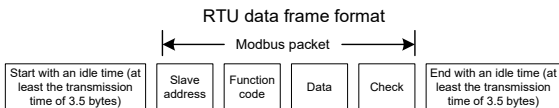

The information of a frame must be transmitted in a continuous data flow. If there is an interval greater than the transmission time of 1.5 bytes before the transmission of the entire frame is complete, the receiving device deletes the incomplete information, and mistakes the subsequent byte for the address domain of a new frame. Similarly, if the transmission interval between two frames is shorter than the transmission time of 3.5 bytes, the receiving device mistakes it for the data of the last frame. The CRC check value is incorrect due to the disorder of the frames, and thus a communication fault occurs.

The following table describes the standard structure of an RTU frame.

START (frame header)	T1-T2-T3-T4 (time gap with a min. length of 3.5 bytes)
ADDR (slave address domain)	Communication address: 0–247 (in decimal system) (0 indicates the broadcast address)
CMD (function domain)	03H: read slave parameters 06H: write slave parameters
Data domain DATA (N-1) ... DATA (0)	Data of 2*N bytes, main content of the communication as well as the core of data exchanging
LSB of CRC CHK	Detection value: CRC (16 bits)
MSB of CRC CHK	
END (frame tail)	T1-T2-T3-T4 (time gap with a min. length of 3.5 bytes)

7.2.2.2 RTU communication frame error check modes

During the transmission of data, errors may occur due to various factors (such as electromagnetic interference). For example, if the sending message is a logic "1", A-B potential difference on RS485 should be 6V, but in reality, it may be -6V because of electromagnetic interference, and then the other devices take the sent message as logic "0". Without error check, the data receiving device cannot identify data errors and may make a wrong response. The wrong response may cause severe problems. Therefore, the data must be checked.

The check is implemented as follows: The transmitter calculates the to-be-transmitted data based on a specific algorithm to obtain a result, adds the result to the rear of the message, and transmits them together. After receiving the message, the receiver calculates the data based on the same algorithm to obtain a result, and compares the result with that transmitted by the transmitter. If the results are the same, the message is correct. Otherwise, the message is considered wrong.

The error check of a frame includes two parts, namely, bit check on individual bytes (that is, odd/even check using the check bit in the character frame), and whole data check (CRC check).

Bit check on individual bytes (odd/even check)

You can select the bit check mode as required, or you can choose not to perform the check, which will affect the check bit setting of each byte.

Definition of even check: Before the data is transmitted, an even check bit is added to indicate whether the number of "1" in the to-be-transmitted data is odd or even. If it is even, the check bit is set to "0"; and if it is odd, the check bit is set to "1".

Definition of odd check: Before the data is transmitted, an odd check bit is added to indicate whether the number of "1" in the to-be-transmitted data is odd or even. If it is odd, the check bit is set to "0"; and if it is even, the check bit is set to "1".

For example, the data bits to be transmitted are "11001110", including five "1". If the even check is applied, the even check bit is set to "1"; and if the odd check is applied, the odd check bit is set to "0". During the transmission of the data, the odd/even check bit is calculated and placed in the check bit of the frame. The receiving device performs the odd/even check after receiving the data. If it finds that the odd/even parity of the data is inconsistent with the preset information, it determines that a communication error occurs.

Cyclical Redundancy Check (CRC) method

A frame in the RTU format includes an error detection domain based on the CRC calculation. The CRC domain checks all the content of the frame. The CRC domain consists of two bytes, including 16 binary bits. It is calculated by the transmitter and added to the frame. The receiver calculates the CRC of the received frame, and compares the result with the value in the

received CRC domain. If the two CRC values are not equal to each other, errors occur in the transmission.

During CRC, 0xFFFF is stored first, and then a process is invoked to process a minimum of 6 contiguous bytes in the frame based on the content in the current register. CRC is valid only for the 8-bit data in each character. It is invalid for the start, stop, and check bits.

During the generation of the CRC values, the "exclusive or" (XOR) operation is performed on the each 8-bit character and the content in the register. The result is placed in the bits from the low-order bit to the high-order bit, and 0 is placed in the high-order bit. Then, the low-order bit is detected. If the low-order bit is 1, the XOR operation is performed on the current value in the register and the preset value. If low-order bit is 0, no operation is performed. This process is repeated 8 times. After the last bit (8th bit) is detected and processed, the XOR operation is performed on the next 8-bit byte and the current content in the register. The final values in the register are the CRC values obtained after operations are performed on all the bytes in the frame.

The calculation adopts the international standard CRC check rule. You can refer to the related standard CRC algorithm to compile the CRC calculation program as required.

The following example is a simple CRC calculation function for your reference (using the C programming language):

```
unsigned int crc_cal_value(unsigned char *data_value,unsigned char
data_length)
{
int i;
unsigned int crc_value=0xffff;
while(data_length--)
{
  crc_value^=*data_value++;
  for(i=0;i<8;i++)
  {
if(crc_value&0x0001)crc_value=(crc_value>>1)^0xa001;
else crc_value=crc_value>>1;
}
}
return(crc_value);
}
```

In the ladder logic, CKSM uses the table look-up method to calculate the CRC value according to the content in the frame. The program of this method is simple, and the calculation is fast,

but the ROM space occupied is large. Use this program with caution in scenarios where there are space occupation requirements on programs.

7.2.3 ASCII mode

Name	Definition									
Coding system	Communication protocol belongs to hexadecimal system. The meaning of message character in ASCII: "0"... "9", "A"... "F", each hex is represented by the ASCII message corresponds to the character.									
	Character	"0"	"1"	"2"	"3"	"4"	"5"	"6"	"7"	
	ASCII CODE	0x30	0x31	0x32	0x33	0x34	0x35	0x36	0x37	
	Character	"8"	"9"	"A"	"B"	"C"	"D"	"E"	"F"	
ASCII CODE	0x38	0x39	0x41	0x42	0x43	0x44	0x45	0x46		
Data format	Starting bit, 7/8 data bit, check bit and stop bit. The data formats are listed as follows.									
	11-bit character frame:									
	Starting bit	BIT 1	BIT2	BIT3	BIT4	BIT5	BIT6	BIT7	BIT 8	Check bit
10-bit character frame:										
Starting bit	BIT1	BIT2	BIT3	BIT4	BIT5	BIT6	BIT7	Check bit	Stop bit	

In ASCII mode, the frame header is ":" ("0*3A"), frame end is "CRLF" ("0*0D" "0*0A") by default. In ASCII mode, all the data bytes, except for the frame header and frame end, are transmitted in ASCII code mode, in which four MSB groups will be sent out first and then, four LSB groups will be sent out. In ASCII mode, the data length is 8 bit. As for "A"- "F", its capital letters is adopted for ASCII code. The data now adopts LRC checkout which covers slave address to data information. The checksum equals to the complement of the character sum of all the participated checkout data.

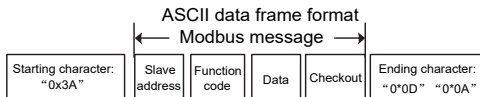

Standard structure of ASCII frame:

START	":" (0x3A)
Address Hi	Communication address:
Address Lo	8-bit address is formed by the combination of two ASCII codes
Function Hi	Function code:

Function Lo	8-bit address is formed by the combination of two ASCII codes
DATA (N-1) ... DATA (0)	Data content: nx8-bit data content is formed by combination of 2n (n≤16) ASCII codes
LRC CHK Hi	LRC check code:
LRC CHK Lo	8-bit check code is formed by the combination of two ASCII codes.
END Hi	End character:
END Lo	END Hi=CR (0x0D), END Lo=LF (0x0A)

7.2.3.1 ASCII mode check (LRC Check)

Check code (LRC Check) is the value combined of address and data content result. For instance, the check code of above 2.2.2 communication message is: 0x02+0x06+0x00+0x08+0x13+0x88=0xAB, then take the compliment of 2=0x55.

The following example is a simple LRC calculation function for your reference (using the C programming language):

```

Static unsigned char
LRC (auchMsg, usDataLen)
unsigned char *auchMsg;
unsigned short usDataLen;
{
unsigned char uchLRC=0;
while (usDataLen--)
uchLRC+=*auchMsg++;
return ((unsigned char) (~((char)uchLRC)));
}

```

7.3 Command code and communication data

7.3.1 RTU mode

7.3.1.1 Command code 03H (corresponding to binary 0000 0011), read N words (Word) (N≤16)

Command code 03H means that if the master read data from the VFD, the reading number depends on the "data number" in the command code. The max continuous reading number is 16 and the parameter address should be continuous. The byte length of every data is 2 (one word). The following command format is illustrated by hex (a number with "H" means hex) and one hex occupies one byte.

The command code is used to read the working state of the VFD.

For example, read continuous 2 data content from 0004H from the VFD with the address of 01H (read the content of data address of 0004H and 0005H), the frame structure is as follows.

RTU master command (sent from the master to the VFD)		RTU slave response (sent from the VFD to the master)	
START	T1-T2-T3-T4	START	T1-T2-T3-T4
ADDR	01H	ADDR	01H
CMD	03H	CMD	03H
		Byte number	04H
MSB of the start address	00H	MSB of data in 0004H	13H
LSB of the start address	04H	LSB of data in 0004H	88H
MSB of data number	00H	MSB of data in 0005H	00H
LSB of data number	02H	LSB of data in 0005H	00H
LSB of CRC	85H	LSB of CRC CHK	7EH
MSB of CRC	CAH	LSB of CRC CHK	9DH
END	T1-T2-T3-T4	END	T1-T2-T3-T4

T1-T2-T3-T4 between START and END is to provide at least the time of 3.5 bytes as the leisure time and distinguish two messages for the avoidance of taking two messages as one message.

ADDR = 01H means the command message is sent to the VFD with the address of 01H and ADDR occupies one byte

CMD=03H means the command message is sent to read data from the VFD and CMD occupies one byte

"Start address" means reading data from the address and it occupies 2 bytes with the fact that the MSB is in the front and the LSB is in the behind.

"Data number" means the reading data number with the unit of word. If the "start address" is 0004H and the "data number" is 0002H, the data of 0004H and 0005H will be read.

CRC occupies 2 bytes with the fact that the LSB is in the front and the MSB is in the behind.

The meaning of the response is that:

ADDR = 01H means the command message is transmitted by the VFD whose address is 01H. The ADDR information occupies one byte.

CMD=03H means the message is received from the VFD to the master for the response of reading command The CMD information occupies one byte.

"Byte number" means all byte number from the byte (excluding the byte) to CRC byte (excluding the byte). 04 means there are 4 byte of data from the "byte number" to "LSB of CRC CHK", which are "MSB of data in 0004H", "LSB of data in 0004H", "MSB of data in 0005H" and "LSB of data in 0005H".

There are 2 bytes stored in one data with the fact that the MSB is in the front and the LSB is in the behind of the message, the data of data address 0004H is 1388H, and the data of data address 0005H is 0000H.

CRC occupies 2 bytes with the fact that the LSB is in the front and the MSB is in the behind.

7.3.1.2 Command code 06H (corresponding to binary 0000 0110), write a word

The command means that the master write data to the VFD and one command can write one data other than multiple dates. The effect is to change the working mode of the VFD.

For example, write 5000 (1388H) to 0004H from the VFD with the address of 02H, the frame structure is as follows.

RTU master command (sent from the master to the VFD)		RTU slave response (sent from the VFD to the master)	
START	T1-T2-T3-T4	START	T1-T2-T3-T4
ADDR	02H	ADDR	02H
CMD	06H	CMD	06H
MSB of data writing address	00H	MSB of data writing address	00H
LSB of data writing address	04H	LSB of data writing address	04H
MSB of to-be-written data	13H	MSB of to-be-written data	13H
LSB of to-be-written data	88H	LSB of to-be-written data	88H
LSB of CRC CHK	C5H	LSB of CRC CHK	C5H
MSB of CRC CHK	6EH	MSB of CRC CHK	6EH
END	T1-T2-T3-T4	END	T1-T2-T3-T4

Note: Sections 7.3.1.1 and 7.3.1.2 mainly describe the command format.

7.3.1.3 Command code 10H, continuous writing

Command code 10H means that if the master writes data to the VFD, the data number depends on the "data number" in the command code. The max continuous reading number is 16.

For example, write 5000 (1388H) to 0004H of the VFD whose slave address is 02H and 50 (0032H) to 0005H, the frame structure is as follows.

The RTU request command is:

START	T1-T2-T3-T4 (time gap with a min. length of 3.5 bytes)
ADDR	02H
CMD	10H
MSB of data writing address	00H
LSB of data writing address	04H
MSB of data quantity	00H
LSB of data quantity	02H
Byte number	04H
MSB of data in 0004H	13H
LSB of data in 0004H	88H
MSB of data in 0005H	00H
LSB of data in 0005H	32H
LSB of CRC	C5H
MSB of CRC	6EH
END	T1-T2-T3-T4 (time gap with a min. length of 3.5 bytes)

The RTU response command is:

START	T1-T2-T3-T4 (time gap with a min. length of 3.5 bytes)
ADDR	02H
CMD	10H
MSB of data writing address	00H
LSB of data writing address	04H
MSB of data quantity	00H
LSB of data quantity	02H
LSB of CRC	C5H
MSB of CRC	6EH
END	T1-T2-T3-T4 (time gap with a min. length of 3.5 bytes)

7.3.2 ASCII mode

7.3.2.1 Command code: 03H (0000 0011), read N words (Word) (max. number for continuous reading is 16 words)

For instance: As for the VFD whose slave address is 01H, the starting address of internal storage is 0004, read two words continuously, the structure of this frame is listed as follows.

ASCII master command (sent from the master to the VFD)		ASCII slave response (sent from the VFD to the master)	
START	":"	START	":"

ASCII master command (sent from the master to the VFD)		ASCII slave response (sent from the VFD to the master)	
ADDR	"0"	ADDR	"0"
	"1"		"1"
CMD	"0"	CMD	"0"
	"3"		"3"
MSB of starting address	"0"	Byte number	"0"
	"0"		"4"
LSB of starting address	"0"	MSB of data address 0004H	"1"
	"4"		"3"
MSB of data number	"0"	LSB of data address 0004H	"8"
	"0"		"8"
LSB of data number	"0"	MSB of data address 0005H	"0"
	"2"		"0"
LRC CHK Hi	"F"	LSB of data address 0005H	"0"
LRC CHK Lo	"6"		"0"
END Hi	CR	LRC CHK Hi	"5"
END Lo	LF	LRC CHK Lo	"D"
		END Hi	CR
		END Lo	LF

7.3.2.2 Command code: 06H (0000 0110), write a word (Word)

For instance: Write 5000 (1388H) to the 0004H address of the VFD whose slave address is 02H, then the structure of this frame is listed as follows.

ASCII master command (sent from the master to the VFD)		ASCII slave response (sent from the VFD to the master)	
START	":"	START	":"
ADDR	"0"	ADDR	"0"
	"2"		"2"
CMD	"0"	CMD	"0"
	"6"		"6"
MSB of data writing address	"0"	MSB of data writing address	"0"
	"0"		"0"
LSB of data writing address	"0"	LSB of data writing address	"0"
	"4"		"4"
MSB of to-be-written data	"1"	MSB of to-be-written data	"1"
	"3"		"3"
LSB of to-be-written data	"8"	LSB of to-be-written data	"8"
	"8"		"8"

ASCII master command (sent from the master to the VFD)		ASCII slave response (sent from the VFD to the master)	
LRC CHK Hi	"5"	LRC CHK Hi	"5"
LRC CHK Lo	"9"	LRC CHK Lo	"9"
END Hi	CR	END Hi	CR
END Lo	LF	END Lo	LF

7.3.2.3 Command code: 08H (0000 1000), diagnosis

Meaning of sub function code:

Sub-function code	Instruction
0000	Return data based on query requests

For example, to query about the circuit detection information about the VFD whose address is 01H, the query and return strings are the same, and the formats are described in the following tables.

ASCII master command (sent from the master to the VFD)		ASCII slave response (sent from the VFD to the master)	
START	":"	START	":"
ADDR	"0"	ADDR	"0"
	"1"		"1"
CMD	"0"	CMD	"0"
	"8"		"8"
MSB of data writing address	"0"	MSB of data writing address	"0"
LSB of data writing address	"0"	LSB of data writing address	"0"
MSB of to-be-written data	"0"	MSB of to-be-written data	"0"
	"0"		"0"
MSB of data writing address	"1"	MSB of data writing address	"1"
LSB of data writing address	"2"	LSB of data writing address	"2"
MSB of to-be-written data	"A"	MSB of to-be-written data	"A"
	"B"		"B"
LRC CHK Hi	"3"	LRC CHK Hi	"3"
LRC CHK Lo	"A"	LRC CHK Lo	"A"
END Hi	CR	END Hi	CR
END Lo	LF	END Lo	LF

7.3.2.4 Command code: 10H, continuous writing

Command code 10H means the master write data to the VFD, the number of data being written is determined by the command "data number", the max. number of continuous writing is 16 words.

For instance: Write 5000 (1388H) to 0004H of the VFD whose slave address is 02H, write 50 (0032H) to 0005H of the VFD whose slave address is 02H, then the structure of this frame is listed as follows.

ASCII master command (sent from the master to the VFD)		ASCII slave response (sent from the VFD to the master)	
START	","	START	","
ADDR	"0"	ADDR	"0"
	"2"		"2"
CMD	"1"	CMD	"1"
	"0"		"0"
MSB of starting address	"0"	MSB of starting address	"0"
	"0"		"0"
LSB of starting address	"0"	LSB of starting address	"0"
	"4"		"4"
MSB of data number	"0"	MSB of data number	"0"
	"0"		"0"
LSB of data number	"0"	LSB of data number	"0"
	"2"		"2"
Byte number	"0"	LRC CHK Hi	"E"
	"4"	LRC CHK Lo	"8"
MSB of data to be written to 0004H LSB of data to be written to 0004H	"1"	END Hi	CR
	"3"	END Lo	LF
MSB of data to be written to 0005H	"8"	/	/
	"8"	/	/
MSB of data to be written to 0004H LSB of data to be written to 0004H	"0"	/	/
	"0"	/	/
MSB of data to be written to 0005H	"3"	/	/
	"2"	/	/
LRC CHK Hi	"1"	/	/
LRC CHK Lo	"7"	/	/

ASCII master command (sent from the master to the VFD)		ASCII slave response (sent from the VFD to the master)	
END Hi	CR	/	/
END Lo	LF	/	/

7.4 Data address definition

This section describes the address definition of communication data. The addresses are used for controlling the running, obtaining the status information, and setting function parameters of the VFD.

7.4.1 Function code address format rules

The parameter address occupies 2 bytes with the fact that the MSB is in the front and the LSB is in the behind. The range of MSB and LSB are: MSB—00—ffH; LSB—00—ffH. The MSB is the group number before the radix point of the function code and the LSB is the number after the radix point. But both the MSB and the LSB should be changed into hex. For example P05.05, the group number before the radix point of the function code is 05, then the MSB of the parameter is 05, the number after the radix point 05, then the LSB of the parameter is 05, then the function code address is 0505H and the parameter address of P10.01 is 0A01H.

Function code	Name	Description	Default	Modify
P10.00	Simple PLC mode	0: Stop after running once. 1: Keep running in the final value after running once. 2: Cyclic running.	0	<input type="radio"/>
P10.01	Simple PLC memory selection	0: No memory after power-off 1: Memory after power-off	0	<input type="radio"/>

Note:

- ◇ P29 group is the factory parameter which cannot be read or changed. Some parameters cannot be changed when the VFD is in the running state and some parameters cannot be changed in any state. The setting range, unit and related instructions should be paid attention to when modifying the function code parameters.
- ◇ Besides, EEPROM is stocked frequently, which may shorten the usage time of EEPROM. For users, some functions are not necessary to be stocked on the communication mode. The needs can be met on by changing the value in RAM. Changing the MSB of the function code form 0 to 1 can also realize the function. For example, the function code P00.07 is not stocked into EEPROM. Only by changing the value in RAM can set the address to 8007H. This address can only be used in writing RAM other than reading. If it is used to read, it is an invalid address.

7.4.2 Description of other function addresses in Modbus

The master can operate on the parameters of the VFD as well as control the VFD, such as running or stopping and monitoring the working state of the VFD.

Below is the parameter list of other functions.

Function instruction	Address definition	Data meaning instruction	R/W characteristics
Communication control command	2000H	0001H: Forward running	R/W
		0002H: Reverse running	
		0003H: Forward jogging	
		0004H: Reverse jogging	
		0005H: Stop	
		0006H: Coast to stop	
		0007H: Fault reset	
		0008H: Jogging to stop	
Address of the communication setting value	2001H	Communication setting frequency (0–Fmax (unit: 0.01Hz))	R/W
	2002H	PID reference, range (0–1000, 1000 corresponds to 100.0%)	R/W
	2003H	PID feedback, range (0–1000, 1000 corresponds to 100.0%)	R/W
	2004H	Torque setting value (-3000–3000, 1000 corresponds to the 100.0% of the rated current of the motor)	R/W
	2005H	The upper limit frequency setting during forward rotation (0–Fmax (unit: 0.01Hz))	R/W
	2006H	The upper limit frequency setting during reverse rotation (0–Fmax (unit: 0.01Hz))	R/W
	2007H	The upper limit torque of electromotion torque (0–3000, 1000 corresponds to the 100.0% of the rated current of the motor)	R/W
	2008H	The upper limit torque of braking torque (0–3000, 1000 corresponds to the 100.0% of the rated current of the motor)	R/W
	2009H	Special control command word Bit0–1: =00: motor 1 =01: motor 2 =10: motor 3 =11: motor 4 Bit2: =1 torque control prohibit =0: torque control prohibit invalid Bit3: =1 power consumption clear	R/W

Function instruction	Address definition	Data meaning instruction	R/W characteristics
		=0: no power consumption clear Bit4: =1 pre-exciting =0: pre-exciting prohibition Bit5: =1 DC braking =0: DC braking prohibition	
	200AH	Virtual input terminal command, range: 0x000–0x1FF	R/W
	200BH	Virtual output terminal command, range: 0x00–0x0F	R/W
	200CH	Voltage setting value (special for V/F separation) (0–1000, 1000 corresponds to the 100.0% of the rated voltage of the motor)	R/W
	200DH	AO output setting 1 (-1000–1000, 1000 corresponds to 100.0%)	R/W
	200EH	AO output setting 2 (-1000–1000, 1000 corresponds to 100.0%)	R/W
SW 1 of the VFD	2100H	0001H: Forward running	R
		0002H: Forward running	
		0003H: Stop	
		0004H: Fault	
		0005H: POFF state	
		0006H: Pre-exciting state	
SW 1 of the VFD	2101H	Bit0: =0: bus voltage is not established =1: bus voltage is established Bit1–2: =00: motor 1 =01: motor 2 =10: motor 3 =11: motor 4 Bit3: =0: asynchronous motor =1: synchronous motor Bit4: =0: pre-alarm without overload =1: overload pre-alarm Bit5–Bit6: =00: keypad control =01: terminal control =10: communication control	R
Fault code of the VFD	2102H	See the fault type instruction	R

Function instruction	Address definition	Data meaning instruction	R/W characteristics	
Identifying code of the VFD	2103H	GD20-----0x0106	R	
Running frequency	3000H	0-Fmax (Unit: 0.01Hz)	R	
Set frequency	3001H	0-Fmax (Unit: 0.01Hz)	R	
Bus voltage	3002H	0.0-2000.0V (Unit: 0.1V)	R	
Output voltage	3003H	0-1200V (Unit: 1V)	R	
Output current	3004H	0.0-3000.0A (Unit: 0.1A)	R	
Rotating speed	3005H	0-65535 (Unit: 1RPM)	R	
Output power	3006H	-300.0-300.0% (Unit: 0.1%)	R	
Output torque	3007H	-250.0-250.0% (Unit: 0.1%)	R	
PID setting	3008H	-100.0-100.0% (Unit: 0.1%)	R	
PID feedback	3009H	-100.0-100.0% (Unit: 0.1%)	R	
Input state	300AH	000-1FF	Compatible with GD series, CHF100A, and CHV100 communication addresses	
Output state	300BH	000-1FF		
AI 1	300CH	0.00-10.00V (Unit: 0.01V)		
AI 2	300DH	0.00-10.00V (Unit: 0.01V)		
AI 3	300EH	-10.00-10.00V (Unit: 0.01V)		
AI 4	300FH	Reserved		
Read input of high-speed pulse 1	3010H	0.00-50.00kHz (Unit: 0.01Hz)		
Read input of high-speed pulse 2	3011H	Reserved		
PLC and current step of multi-step speed	3012H	0-15		
External length	3013H	0-65535		
				R

Function instruction	Address definition	Data meaning instruction		R/W characteristics
External count value	3014H	0-65535		R
Torque setting	3015H	-300.0-300.0% (Unit: 0.1%)		R
VFD identification code	3016H			R
Fault code	5000H			R

R/W characteristics means the function is with read and write characteristics. For example, "communication control command" is writing characteristics and control the VFD with writing command (06H). R characteristic can only read other than write and W characteristic can only write other than read.

Note: when operating on the VFD with the table above, it is necessary to enable some parameters. For example, the operation of running and stopping, it is necessary to set [P00.01](#) to communication running command channel. And when operate on "PID given", it is necessary to set [P09.00](#) to "Modbus communication setting".

The encoding rules for device codes (corresponding to identifying code 2103H of the VFD

MSB of code	Meaning	LSB of code	Meaning
01	Goodrive	06	Goodrive20 Vector VFD

Note:

The code is consisted of 16 bit which is high 8 bits and low 8 bits. High 8 bits mean the motor type series and low 8 bits mean the derived motor types of the series.

7.4.3 Fieldbus ratio values

The communication data is expressed by hex in actual application and there is no radix point in hex. For example, 50.12Hz cannot be expressed by hex so 50.12 can be magnified by 100 times into 5012, so hex 1394H can be used to express 50.12.

A non-integer can be timed by a multiple to get an integer and the integer can be called fieldbus ratio values.

The fieldbus ratio values are referred to the radix point of the setting range or default value in the function parameter list. If there are figures behind the radix point ($n=1$), then the fieldbus ratio value m is 10^n . Take the table as the example:

Function code	Name	Description	Default	Modify
P01.20	Wake-up-from-sleep delay	0.0-3600.0s (valid when P01.19 is 2)	0.0s	○

Function code	Name	Description	Default	Modify
P01.21	Power-off restart selection	0: Disable 1: Enable	0	○

The value specified in "Setting range" or "Default" contains one decimal, so the fieldbus scale is 10. If the value received by the upper computer is 50, the value of "Wake-up-from-sleep delay" of the VFD is 5.0 (5.0=50/10).

To set the "Wake-up-from-sleep delay" to 5.0s through Modbus communication, you need first to multiply 5.0 by 10 according to the scale to obtain an integer 50, that is, 32H in the hexadecimal form, and then transmit the following write command:

01 06 01 14 00 32 49 E7

VFD Write Parameters Data number CRC check
address command address

After receiving the command, the VFD converts 50 into 5.0 based on the fieldbus scale, and then sets "Wake-up-from-sleep delay" to 5.0s.

For another example, after the upper computer transmits the "Wake-up-from-sleep delay" parameter command, the master receives the following response from the VFD:

01 03 02 00 32 39 91

VFD Read 2-byte Parameters CRC check
address command data data

The parameter data is 0032H, that is, 50, so 5.0 is obtained based on the fieldbus scale (50/10=5.0). In this case, the master identifies that the "Wake-up-from-sleep delay" is 5.0s.

7.4.4 Error message response

Operation errors may occur in communication-based control. For example, some parameters can only be read, but a write command is transmitted. In this case, the VFD returns an error message response. Error message responses are sent from the VFD to the master. The following table describes the codes and definitions of the error message responses.

Code	Name	Meaning
01H	Invalid command	The command code received by the upper computer is not allowed to be executed. The possible causes are as follows: <ul style="list-style-type: none"> The function code is applicable only on new devices and is not implemented on this device. The slave is in the faulty state when processing this request.
02H	Invalid data address.	For the VFD, the data address in the request of the upper computer is not allowed. In particular, the combination of the

Code	Name	Meaning
		register address and the number of the to-be-transmitted bytes is invalid.
03H	Invalid data value	The received data domain contains a value that is not allowed. The value indicates the error of the remaining structure in the combined request. Note: It does not mean that the data item submitted for storage in the register includes a value unexpected by the program.
04H	Operation failure	The parameter is set to an invalid value in the write operation. For example, a function input terminal cannot be set repeatedly.
05H	Password error	The password entered in the password verification address is different from that set in P07.00.
06H	Data frame error	The length of the data frame transmitted by the upper computer is incorrect, or in the RTU format, the value of the CRC check bit is inconsistent with the CRC value calculated by the lower computer.
07H	Parameter read-only	The parameter to be modified in the write operation of the upper computer is a read-only parameter.
08H	Parameter cannot be modified in running	The parameter to be modified in the write operation of the upper computer cannot be modified during the running of the VFD.
09H	Password protection	A user password is set, and the upper computer does not provide the password to unlock the system when performing a read or write operation. The error of "system locked" is reported.

The slave uses functional code fields and fault addresses to indicate it is a normal response or some error occurs (named as objection response). For normal responses, the slave shows corresponding function codes, digital address or sub-function codes as the response. For objection responses, the slave returns a code which equals the normal code, but the first byte is logic 1.

For example: when the master sends a message to the slave, requiring it to read a group of address data of the VFD function codes, there will be following function codes:

0 0 0 0 0 1 1 (Hex 03H)

For normal responses, the slave responds the same codes, while for objection responses, it will return:

1 0 0 0 0 1 1 (Hex 83H)

Besides the function codes modification for the objection fault, the slave will respond a byte of abnormal code which defines the error reason.

When the master receives the response for the objection, in a typical processing, it will send the message again or modify the corresponding order.

For example, set the "running command channel" of the VFD ([P00.01](#), parameter address is 0001H) with the address of 01H to 03, the command is as following:

<u>01</u>	<u>06</u>	<u>00 01</u>	<u>00 03</u>	<u>98 0B</u>
VFD address	Write command	Parameters address	Parameters data	CRC check

But the setting range of "running command channel" is 0–2, if it is set to 3, because the number is beyond the range, the VFD will return fault response message as follows.

<u>01</u>	<u>86</u>	<u>04</u>	<u>43 A3</u>
VFD address	Abnormal response code	Fault code	CRC check

Abnormal response code 86H means the abnormal response to writing command 06H; the fault code is 04H. In the table above, its name is operation failed and its meaning is that the parameter setting in parameter writing is invalid. For example, the function input terminal cannot be set repeatedly.

7.5 Read/Write operation example

For details about the formats of the read and write commands, see section 7.3.

7.5.1 Examples of reading command 03H

Example 1: Read the state word 1 of the VFD whose address is 01H. See section 7.4.2 "Description of other function addresses in Modbus", the parameter address of the state word 1 of the VFD is 2100H.

RTU mode:

The command sent to the VFD:

<u>01</u>	<u>03</u>	<u>21 00</u>	<u>00 01</u>	<u>8E 36</u>
VFD address	Read command	Parameters address	Data number	CRC check

If the response message is as follows.

<u>01</u>	<u>03</u>	<u>02</u>	<u>00 03</u>	<u>F8 45</u>
VFD address	Read command	Data address	Data content	CRC check

ASCII mode:

The command sent to the VFD:

:	<u>01</u>	<u>03</u>	<u>21 00</u>	<u>00 01</u>	<u>DA</u>	<u>CR LF</u>
START	VFD address	Read command	Parameters address	Data number	LRC check	END

If the operation is successful, the following response is returned:

:	<u>01</u>	<u>03</u>	<u>02</u>	<u>00 03</u>	<u>F7</u>	<u>CR LF</u>
START	VFD address	Read command	Byte number	Data content	LRC check	END

The data content is 0003H. From the table 1, the VFD stops.

7.5.2 Examples of writing command 06H

Example 1: Set the VFD whose address is 03H to be forward running. See section 7.4.2 "Description of other function addresses in Modbus", the address of "Communication control command" is 2000H, and 0001H indicates forward running.

Function instruction	Address definition	Data meaning instruction	R/W characteristics
Communication control command	2000H	0001H: Forward running	R/W
		0002H: Reverse running	
		0003H: Forward jogging	
		0004H: Reverse jogging	
		0005H: Stop	
		0006H: Coast to stop (emergency stop)	
		0007H: Fault reset	
		0008H: Jogging to stop	

RTU mode:

The command sent by the master:

<u>03</u>	<u>06</u>	<u>20 00</u>	<u>00 01</u>	<u>42 28</u>
VFD address	Write command	Parameters address	Forward running	CRC check

If the operation is successful, the following response (same as the command transmitted from the master) is returned:

<u>03</u>	<u>06</u>	<u>20 00</u>	<u>00 01</u>	<u>42 28</u>
VFD address	Write command	Parameters address	Forward running	CRC check

ASCII mode:

The command sent to the VFD:

:	<u>01</u>	<u>06</u>	<u>20 00</u>	<u>00 01</u>	<u>D6</u>	<u>CR LF</u>
START	VFD address	Write command	Parameters address	Data number	LRC check	END

If the operation is successful, the following response (same as the command transmitted from the master) is returned:

:	<u>01</u>	<u>06</u>	<u>20 00</u>	<u>00 01</u>	<u>D6</u>	<u>CR LF</u>
START	VFD address	Write command	Parameters address	Data number	LRC check	END

Example 2: set the max output frequency of the VFD with the address of 03H as 100Hz.

Function code	Name	Description	Default	Modify
P00.03	Max. output frequency	Used to set the max. output frequency of the VFD. It is the basis of frequency setup and the acceleration/deceleration. Setting range: P00.04 –630.00Hz	50.00Hz	©

See the figures behind the radix point, the fieldbus ratio value of max. output frequency ([P00.03](#)) is 100. 100Hz timed by 100 is 10000 and the corresponding hex is 2710H.

RTU mode:

The command sent by the master:

<u>03</u>	<u>06</u>	<u>00 03</u>	<u>27 10</u>	<u>62 14</u>
VFD address	Write command	Parameters address	Parameter data	CRC check

If the operation is successful, the following response (same as the command transmitted from the master) is returned:

<u>03</u>	<u>06</u>	<u>00 03</u>	<u>27 10</u>	<u>62 14</u>
VFD address	Write command	Parameters address	Parameter data	CRC check

ASCII mode:

The command sent to the VFD:

03 06 00 03 27 10 BD CR LF
 : VFD Write Parameters Parameter LRC END
 START address command address data check

If the operation is successful, the following response (same as the command transmitted from the master) is returned:

03 06 00 03 27 10 BD CR LF
 : VFD Write Parameters Parameter LRC END
 START address command address data check

7.5.3 Examples of continuous writing command10H

Example 1: Set the VFD whose address is 01H to be forward running at the frequency of 10Hz. See section 7.4.2 "Description of other function addresses in Modbus", the address of "Communication control command" is 2000H, and 0001H indicates forward running. The address of "Communication frequency setting" is 2001H, and 10 Hz is 03E8H in the hexadecimal form.

Function instruction	Address definition	Data meaning instruction	R/W characteristics
Communication control command	2000H	0001H: Forward running	R/W
		0002H: Reverse running	
		0003H: Forward jogging	
		0004H: Reverse jogging	
		0005H: Stop	
		0006H: Coast to stop (emergency stop)	
		0007H: Fault reset	
		0008H: Jogging to stop	
Address of communication setting	2001H	Communication setting frequency (0–Fmax (unit: 0.01Hz))	R/W
	2002H	PID given, range (0–1000, 1000 corresponds to 100.0%)	

RTU mode:

The command sent to the VFD:

01 10 20 00 00 02 04 00 01 03 E8 3B 10
 VFD Continuous Parameters Data Byte Forward 10Hz CRC check
 address writing address number number running

If the operation is successful, the following response is returned:

01 10 20 00 00 02 4A 08
 VFD Continuous Parameters Data CRC check
 address writing address number

ASCII mode:

The command sent to the VFD:

: 01 10 20 00 00 02 04 00 01 03 E8 BD CR LF
 START VFD Continuous Parameters Data Byte Forward 10Hz LRC END
 address writing address number number running check

If the operation is successful, the following response is returned:

: 01 10 20 00 00 02 CD CR LF
 START VFD Continuous Parameters Data LRC END
 address writing address number check

Example 2: Set ACC time of 01H VFD as 10s and DEC time as 20s.

P00.11	ACC time 1	Setting range of P00.11 and P00.12 :	Depend on model	○
P00.12	DEC time 1		0.0–3600.0s	Depend on model

The corresponding address of [P00.11](#) is 000B, the ACC time of 10s corresponds to 0064H, and the DEC time of 20s corresponds to 00C8H.

RTU mode:

The command sent to the VFD:

01 10 00 0B 00 02 04 00 64 00 C8 F2 55
 VFD Continuous Parameters Data Byte 10s 20s CRC check
 address writing address number number

If the operation is successful, the following response is returned:

01 10 00 0B 00 02 30 0A
 VFD Continuous Parameters Data CRC check
 address writing address number

ASCII mode:

The command sent to the VFD:

: 01 10 00 0B 00 02 04 00 64 00 C8 B2 CR LF
 START VFD Continuous Parameters Data Number 10s 20s LRC END
 address writing address number of bytes check

If the operation is successful, the following response is returned:

:	<u>01</u>	<u>10</u>	<u>00 0B</u>	<u>00 02</u>	<u>E2</u>	<u>CR LF</u>
START	VFD address	Continuous writing command	Parameters address	Data number	LRC check	END

Note: The blank in the above command is for illustration. The blank cannot be added in the actual application unless the upper monitor can remove the blank by themselves.

7.6 Common communication faults

Common communication faults include the following:

- ✧ No response is returned.
- ✧ The VFD returns an exception response.

Possible causes of no response include the following:

- ✧ The serial port is set incorrectly. For example, the converter uses the serial port COM1, but COM2 is selected for the communication.
- ✧ The settings of the baud rates, data bits, stop bits, and check bits are inconsistent with those set on the VFD.
- ✧ The positive pole (+) and negative pole (-) of the RS485 bus are connected reversely.
- ✧ The RS485 wire cap on the terminal board of the VFD is not connected. This wire cap is at the back of the terminal block.

Appendix A Technical data

A.1 Derated application

A.1.1 Capacity

Choose a VFD based on the rated current and power of the motor. To endure the rated power of the motor, the rated output current of the VFD must be larger or equal to the rated current of the motor. The rated power of the VFD must be higher or equal to that of the motor.

Note:

- ◇ The maximum allowable shaft power of the motor is limited to 1.5 times the rated power of the motor. If the limit is exceeded, the VFD automatically restricts the torque and current of the motor. This function effectively protects the input shaft against overload.
- ◇ The rated capacity is the capacity at the ambient temperature of 40°C.
- ◇ You need to check and ensure that the power flowing through the common DC connection in the common DC system does not exceed the rated power of the motor.

A.1.2 Derating

If the ambient temperature on the site where the VFD is installed exceeds 40°C, the altitude exceeds 1000 m, or the switching frequency is changed from 4 kHz to 8, 12, or 15 kHz, the VFD needs to be derated.

A.1.2.1 Derating due to temperature

When the temperature ranges from +40°C to +50°C, the rated output current is derated by 1% for each increased 1°C. For the actual derating, see the following figure.

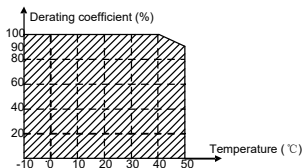

Note: It is not recommended to use the VFD at a temperature higher than 50°C. If you do, you shall be held accountable for the consequences caused.

A.1.2.2 Derating due to altitude

When the altitude of the site where the VFD is installed is lower than 1000m, the VFD can run at the rated power. When the altitude exceeds 1000m, derate by 1% for every increase of 100m. When the altitude exceeds 3000m, consult the local INVT dealer or office for details.

A.1.2.3 Derate due to carrier frequency

The power of Goodrive20 series VFDs varies according to carrier frequencies. The rated power of a VFD is defined based on the carrier frequency set in factory. If the carrier frequency exceeds the factory setting, the power of the VFD is derated by 10% for each increased 1 kHz.

A.2 CE

A.2.1 CE marking

The CE marking on the name plate of a VFD indicates that the VFD is CE-compliant, meeting the regulations of the European low-voltage directive (2014/35/EU) and EMC directive (2014/30/EU).

A.2.2 Directive EMC compliance declaration

European union (EU) stipulates that the electric and electrical devices sold in Europe cannot generate electromagnetic disturbance that exceeds the limits stipulated in related standards, and can work properly in environments with certain electromagnetic interference. The EMC product standard (EN 61800-3) describes the EMC standards and specific test methods for adjustable speed electrical power drive systems. Products must strictly follow these EMC regulations.

A.3 EMC regulations

The EMC product standard (EN 61800-3) describes the EMC requirements on the VFD.

Application environment categories

Category I: Civilian environments, including application scenarios where VFDs are directly connected to the civil power supply low-voltage grids without intermediate transformers

Category II: All environments except those in Category I.

VFD categories

C1: Rated voltage lower than 1000V, applied to environments of Category I.

C2: Rated voltage lower than 1000V, non-plug, socket, or mobile devices; power drive systems that must be installed and operated by specialized personnel when applied to environments of Category I.

Note: The EMC standard IEC/EN 61800-3 no longer restricts the power distribution of VFDs, but it specifies their use, installation, and commissioning. Specialized personnel or organizations must have the necessary skills (including the EMC-related knowledge) for installing and/or performing commissioning on the electrical drive systems.

C3: Rated voltage lower than 1000V, applied to environments of Category II. They cannot be applied to environments of Category I.

C4: Rated voltage higher than 1000V, or rated current higher or equal to 400A, applied to complex systems in environments of Category II.

A.3.1 VFDs of category C2

The induction disturbance limit meets the following stipulations:

1. Select an optional EMC filter according to Appendix C "Optional peripheral accessories" and install it following the description in the EMC filter manual.
2. Select the motor and control cables according to the description in the manual.
3. Install the VFD according to the description in the manual.



⚡ In a domestic environment, this product may cause radio interference, in which case supplementary mitigation measures may be required.

A.3.2 VFDs of category C3

The anti-interference performance of the VFD meets the requirements of environments Category II in the IEC/EN 61800-3 standard.

The induction disturbance limit meets the following stipulations:

1. Select an optional EMC filter according to Appendix C "Optional peripheral accessories" and install it following the description in the EMC filter manual.
2. Select the motor and control cables according to the description in the manual.
3. Install the VFD according to the description in the manual.



⚡ VFDs of C3 category cannot be applied to civilian low-voltage common grids. When applied to such grids, the VFDs may generate radio frequency electromagnetic interference.

Appendix B Dimension drawings

Dimension drawings of the Goodrive20 are shown as follows. The dimensions are given in mm.

B.1 External keypad structure

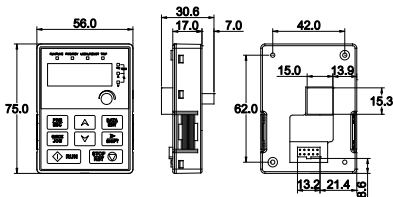

Figure B-1 Keypad outer outline

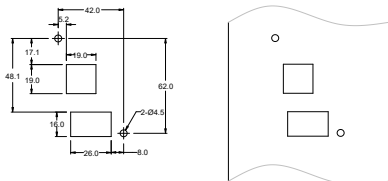

Figure B-2 Hole-cutting diagram for non-bracket keypad

Note: An external keypad is the optional part for the VFD models of 1PH 220V/3PH 380V ($\leq 2.2\text{kW}$) and 3PH 220V ($\leq 0.75\text{kW}$). For the VFD models of 3PH 380V ($\geq 4\text{kW}$) and 3PH 220V ($\geq 1.5\text{kW}$), the keypad can be connected externally.

When connecting the keypad externally, you can install it on the keypad adapter bracket. There are two types of keypad adapter brackets, which are commonly used with the keypad. The keypad adapter brackets are optional parts, and their outline and installation dimensions are shown in Figure B-3.

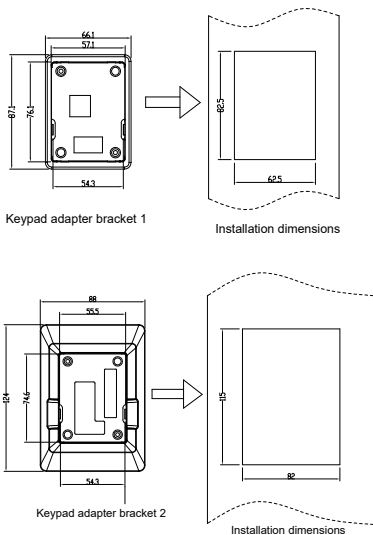

Figure B-3 Outline and installation dimensions

B.2 VFD dimensions

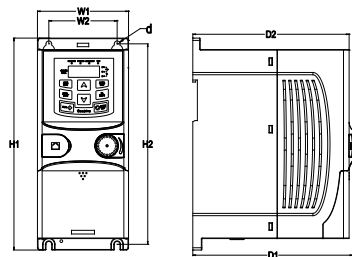
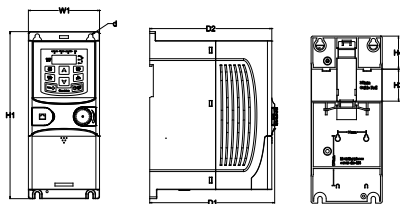

Figure B-4 Wall mounting of VFDs of 1PH 220V/3PH 380V ($\leq 2.2\text{kW}$) and 3PH 220V ($\leq 0.75\text{kW}$)

Model	W1	W2	H1	H2	D1	D2	Installation hole (d)	Weight (kg)
GD20-0R4G-S2	80.0	60.0	160.0	150.0	123.5	120.3	Ø 5	0.9
GD20-0R7G-S2	80.0	60.0	160.0	150.0	123.5	120.3	Ø 5	0.9
GD20-1R5G-S2	80.0	60.0	185.0	175.0	140.5	137.3	Ø 5	1.2
GD20-2R2G-S2	80.0	60.0	185.0	175.0	140.5	137.3	Ø 5	1.2
GD20-0R4G-2	80.0	60.0	185.0	175.0	140.5	137.3	Ø 5	1
GD20-0R7G-2	80.0	60.0	185.0	175.0	140.5	137.3	Ø 5	1
GD20-0R7G-4	80.0	60.0	185.0	175.0	140.5	137.3	Ø 5	1
GD20-1R5G-4	80.0	60.0	185.0	175.0	140.5	137.3	Ø 5	1
GD20-2R2G-4	80.0	60.0	185.0	175.0	140.5	137.3	Ø 5	1

Figure B-5 Rail mounting of VFDs of 1PH 220V/3PH 380V ($\leq 2.2\text{kW}$) and 3PH 220V ($\leq 0.75\text{kW}$)

Model	W1	H1	H3	H4	D1	D2	Installation hole (d)	Weight (kg)
GD20-0R4G-S2	80.0	160.0	35.4	36.6	123.5	120.3	Ø 5	0.9
GD20-0R7G-S2	80.0	160.0	35.4	36.6	123.5	120.3	Ø 5	0.9
GD20-1R5G-S2	80.0	185.0	35.4	36.6	140.5	137.3	Ø 5	1.2
GD20-2R2G-S2	80.0	185.0	35.4	36.6	140.5	137.3	Ø 5	1.2
GD20-0R4G-2	80.0	185.0	35.4	36.6	140.5	137.3	Ø 5	1
GD20-0R7G-2	80.0	185.0	35.4	36.6	140.5	137.3	Ø 5	1
GD20-0R7G-4	80.0	185.0	35.4	36.6	140.5	137.3	Ø 5	1
GD20-1R5G-4	80.0	185.0	35.4	36.6	140.5	137.3	Ø 5	1
GD20-2R2G-4	80.0	185.0	35.4	36.6	140.5	137.3	Ø 5	1

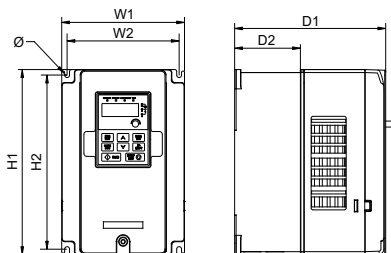

Figure B-6 Wall mounting of VFDs of 3PH 380V (4-37kW) and 3PH 220V (1.5-7.5kW)

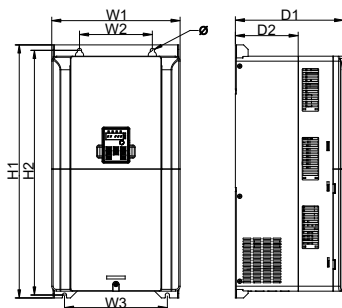

Figure B-7 Wall mounting of VFDs of 3PH 380V (45-75kW)

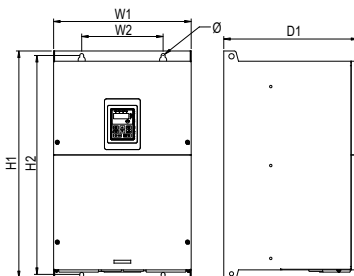

Figure B-8 Wall mounting of VFDs of 3PH 380V (90-110kW)

Model	W1	W2	W3	H1	H2	D1	D2	Installation hole	Weight (kg)
GD20-1R5G-2	146.0	131.0	—	256.0	243.5	167.0	84.5	Ø 6	3.1
GD20-2R2G-2	146.0	131.0	—	256.0	243.5	167.0	84.5	Ø 6	3.1
GD20-004G-2	146.0	131.0	—	256.0	243.5	167.0	84.5	Ø 6	3.1
GD20-5R5G-2	170.0	151.0	—	320.0	303.5	196.3	113.0	Ø 6	5.58
GD20-7R5G-2	170.0	151.0	—	320.0	303.5	196.3	113.0	Ø 6	5.83
GD20-004G-4	146.0	131.0	—	256.0	243.5	167.0	84.5	Ø 6	3.1
GD20-5R5G-4	146.0	131.0	—	256.0	243.5	167.0	84.5	Ø 6	3.1
GD20-7R5G-4	170.0	151.0	—	320.0	303.5	196.3	113.0	Ø 6	5.58
GD20-011G-4	170.0	151.0	—	320.0	303.5	196.3	113.0	Ø 6	5.58
GD20-015G-4	170.0	151.0	—	320.0	303.5	196.3	113.0	Ø 6	5.83
GD20-018G-4	200.0	185.0	—	340.6	328.6	184.3	104.5	Ø 6	9
GD20-022G-4	200.0	185.0	—	340.6	328.6	184.3	104.5	Ø 6	9
GD20-030G-4	250.0	230.0	—	400.0	380.0	202.0	123.5	Ø 6	15.5
GD20-037G-4	250.0	230.0	—	400.0	380.0	202.0	123.5	Ø 6	15.5
GD20-045G-4	282.0	160.0	226.0	560.0	542.0	238.0	138.0	Ø 9	25
GD20-055G-4	282.0	160.0	226.0	560.0	542.0	238.0	138.0	Ø 9	25
GD20-075G-4	282.0	160.0	226.0	560.0	542.0	238.0	138.0	Ø 9	25
GD20-090G-4	338.0	200.0	—	554.0	535.0	329.2	—	Ø 9.5	45
GD20-110G-4	338.0	200.0	—	554.0	535.0	329.2	—	Ø 9.5	45

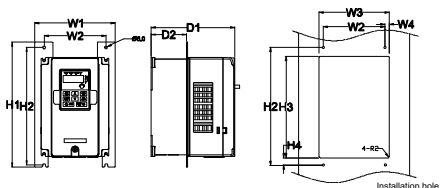

Figure B-9 Flange mounting of VFDs of 3PH 380V (4–75kW) and 3PH 220V (1.5–7.5kW)

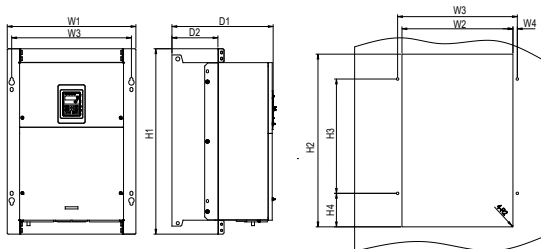

Figure B-10 Flange mounting of VFDs of 3PH 380V (90–110kW)

Model	W1	W2	W3	W4	H1	H2	H3	H4	D1	D2	Installation hole	Screw	Weight (kg)
GD20-1R5G-2	170.2	131	150	9.5	292	276	260	6	167	84.5	Ø 6	M5	3.1
GD20-2R2G-2	170.2	131	150	9.5	292	276	260	6	167	84.5	Ø 6	M5	3.1
GD20-004G-2	170.2	131	150	9.5	292	276	260	6	167	84.5	Ø 6	M5	3.1
GD20-5R5G-2	191.2	151	174	11.5	370	351	324	12	196.3	113	Ø 6	M5	5.58
GD20-7R5G-2	191.2	151	174	11.5	370	351	324	12	196.3	113	Ø 6	M5	5.83
GD20-004G-4	170.2	131	150	9.5	292	276	260	6	167	84.5	Ø 6	M5	3.1
GD20-5R5G-4	170.2	131	150	9.5	292	276	260	6	167	84.5	Ø 6	M5	3.1
GD20-7R5G-4	191.2	151	174	11.5	370	351	324	12	196.3	113	Ø 6	M5	5.58
GD20-011G-4	191.2	151	174	11.5	370	351	324	12	196.3	113	Ø 6	M5	5.58
GD20-015G-4	191.2	151	174	11.5	370	351	324	12	196.3	113	Ø 6	M5	5.83
GD20-018G-4	266	250	224	13	371	250	350.6	20.3	184.6	104	Ø 6	M5	9
GD20-022G-4	266	250	224	13	371	250	350.6	20.3	184.6	104	Ø 6	M5	9
GD20-030G-4	316	300	274	13	430	300	410	55	202	118.3	Ø 6	M5	15.5
GD20-037G-4	316	300	274	13	430	300	410	55	202	118.3	Ø 6	M5	15.5
GD20-045G-4	352	332	306	13	580	400	570	80	238	133.8	Ø 9	M8	25
GD20-055G-4	352	332	306	13	580	400	570	80	238	133.8	Ø 9	M8	25
GD20-075G-4	352	332	306	13	580	400	570	80	238	133.8	Ø 9	M8	25
GD20-090G-4	418.5	361	389.5	14.2	600	559	370	108.5	329.5	149.5	Ø 9.5	M8	45
GD20-110G-4	418.5	361	389.5	14.2	600	559	370	108.5	329.5	149.5	Ø 9.5	M8	45

Note: Installation brackets are optional parts for flange mounting.

Appendix C Optional peripheral accessories







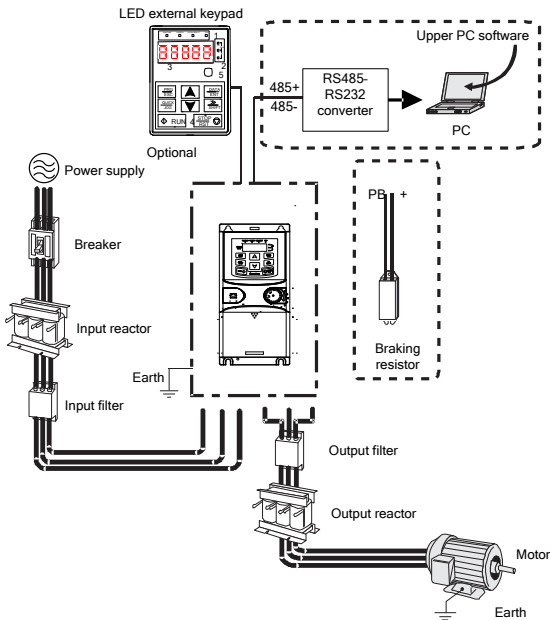

This chapter describes how to select optional accessories of the VFD.

C.1 Wiring of peripheral accessories

The following figure shows the external wiring of the VFD.



Pictures	Name	Descriptions
	External keypad	External keypads include the external keypads with and without the function of parameter copying. When the external keypad with parameter copying is valid, the local keypad is off; when the external keypad without parameter copying is valid, the local and external keypads are on simultaneously.

Pictures	Name	Descriptions
	Cable	Accessory for signal transmission.
	Breaker	Device for electric shock prevention and protection against short-to-ground that may cause current leakage and fire. Select residual-current circuit breakers (RCCBs) that are applicable to VFDs and can restrict high-order harmonics, and of which the rated sensitive current for one VFD is larger than 30 mA.
	Input reactor	Accessories used to improve the current adjustment coefficient on the input side of the VFD, and thus restrict high-order harmonic currents.
	Input filter	Accessory that restricts the electromagnetic interference generated by the VFD and transmitted to the public grid through the power cable. Try to install the input filter near the input terminal side of the VFD.
	Braking resistor	Accessories used to consume the regenerative energy of the motor to reduce the DEC time. The VFD models need only to be configured with braking resistors.
	Output filter	Accessory used to restrict interference generated in the wiring area on the output side of the VFD. Try to install the output filter near the output terminal side of the VFD.
	Output reactor	Accessory used to lengthen the valid transmission distance of the VFD, which effectively restrict the transient high voltage generated during the switch-on and switch-off of the IGBT module of the VFD.
	Membrane of heat releasing holes at the side	Accessory applied in severe environment scenarios for improving protective effect. The VFD can be derated by 10% through using the membrane.

C.2 Power supply

	⚡ Ensure that the voltage class of the VFD is consistent with that of the grid.
--	---

C.3 Cables

C.3.1 Power cables

The sizes of the input power cables and motor cables must meet the local regulation.

Note: If the conductivity of the shielding layer of the motor cables cannot meet the requirements, separate PE conductors must be used.

C.3.2 Control cables

All analog control cables and cables used for frequency input must be shielded cables.

Relay cables need to be those with metal braided shield layers.

Keypads need to be connected by using network cables. In complicated electromagnetic environments, shielded network cables are recommended.

Note:

- ✧ Analog signals and digital signals cannot use the same cables, and their cables must be arranged separately.
- ✧ Check the insulation conditions of the input power cable of a VFD according to the local regulations before connecting it.

Model	Recommended cable size (mm ²)		Size of connectable cable (mm ²)			Terminal screw	Tightening torque (Nm)
	RST	PE	RST	P1, (+)	PE		
	UVW		UVW				
GD20-0R4G-S2	1.5	1.5	1-4	1-4	1-4	M3	0.8
GD20-0R7G-S2	1.5	1.5	1-4	1-4	1-4	M3	0.8
GD20-1R5G-S2	2.5	2.5	1-4	1-4	1-4	M3	0.8
GD20-2R2G-S2	2.5	2.5	1-4	1-4	1-4	M3	0.8
GD20-0R4G-2	1.5	1.5	1-1.5	1-1.5	1-1.5	M3	0.8
GD20-0R7G-2	1.5	1.5	1-1.5	1-1.5	1-1.5	M3	0.8
GD20-1R5G-2	2.5	2.5	1.5-6	2.5-6	2.5-6	M4	1.13
GD20-2R2G-2	2.5	2.5	1.5-6	2.5-6	2.5-6	M4	1.13
GD20-004G-2	2.5	2.5	1.5-6	2.5-6	2.5-6	M4	1.13
GD20-5R5G-2	4	4	4-10	4-10	4-10	M5	2.3
GD20-7R5G-2	6	6	4-10	4-10	4-10	M5	2.3
GD20-0R7G-4	1.5	1.5	1-1.5	1-1.5	1-1.5	M3	0.8
GD20-1R5G-4	1.5	1.5	1-1.5	1-1.5	1-1.5	M3	0.8
GD20-2R2G-4	1.5	1.5	1-1.5	1-1.5	1-1.5	M3	0.8
GD20-004G-4	2.5	2.5	2.5-6	2.5-6	2.5-6	M4	1.13
GD20-5R5G-4	2.5	2.5	2.5-6	2.5-6	2.5-6	M4	1.13

Model	Recommended cable size (mm ²)		Size of connectable cable (mm ²)			Terminal screw	Tightening torque (Nm)
	RST	PE	RST	P1, (+)	PE		
	UVW		UVW				
GD20-7R5G-4	4	4	4-10	4-10	4-10	M5	2.3
GD20-011G-4	6	6	4-10	4-10	4-10	M5	2.3
GD20-015G-4	6	6	4-10	4-10	4-10	M5	2.3
GD20-018G-4	10	10	10-16	10-16	10-16	M5	2.3
GD20-022G-4	16	16	10-16	10-16	10-16	M5	2.3
GD20-030G-4	25	16	25-50	25-50	16-25	M6	2.5
GD20-037G-4	25	16	25-50	25-50	16-25	M6	2.5
GD20-045G-4	35	16	35-70	35-70	16-35	M8	10
GD20-055G-4	50	25	35-70	35-70	16-35	M8	10
GD20-075G-4	70	35	35-70	35-70	16-35	M8	10
GD20-090G-4	95	50	70-120	70-120	50-70	M12	35
GD20-110G-4	120	70	70-120	70-120	50-70	M12	35

Note:

- ◇ Cables of the sizes recommended for the main circuit can be used in scenarios where the ambient temperature is lower than 40°C, the wiring distance is shorter than 100 m, and the current is the rated current.
- ◇ The terminals (+) and PB are used to connect to braking resistor.
- ◇ If the control cable and power cable need to be crossed, ensure that the angle between the control cable and the power cable is 90 degrees.
- ◇ If the inside of the motor is wet, the insulation resistance will decrease. If you think there is moisture inside the motor, dry the motor and re-measure it.

C.4 Breaker and electromagnetic contactor

The circuit breaker is mainly used to prevent electric shock accidents and short circuits to the ground that may cause leakage current fire. The electromagnetic contactor is mainly used to control the main circuit power on and off, which can effectively cut off the input power of the VFD in case of system failure to ensure safety.



- ◇ According to the working principle and structure of breakers, if the manufacturer's regulation is not followed, hot ionized gases may escape from the breaker enclosure when a short-circuit occurs. To ensure safe use, exercise extra caution when installing and placing the breaker. Follow the manufacturer's instructions.

Model	Fuse (A)	Breaker (A)	Contactor rated current (A)
GD20-0R4G-S2	10	10	9
GD20-0R7G-S2	16	16	12
GD20-1R5G-S2	25	25	25
GD20-2R2G-S2	50	40	32
GD20-0R4G-2	6	6	9
GD20-0R7G-2	10	10	9
GD20-1R5G-2	16	16	12
GD20-2R2G-2	25	25	18
GD20-004G-2	35	32	25
GD20-5R5G-2	35	32	32
GD20-7R5G-2	50	63	50
GD20-0R7G-4	6	6	9
GD20-1R5G-4	10	10	9
GD20-2R2G-4	10	10	9
GD20-004G-4	25	25	25
GD20-5R5G-4	35	32	25
GD20-7R5G-4	50	40	38
GD20-011G-4	63	63	50
GD20-015G-4	63	63	50
GD20-018G-4	100	100	65
GD20-022G-4	100	100	80
GD20-030G-4	125	125	95
GD20-037G-4	150	160	115
GD20-045G-4	150	200	170
GD20-055G-4	200	200	170
GD20-075G-4	250	250	205
GD20-090G-4	325	315	245
GD20-110G-4	350	350	300

C.5 Reactors

When the voltage of the grid is high, the transient large current that flows into the input power circuit may damage rectifier components. You need to configure an AC reactor on the input side, which can also improve the current adjustment coefficient on the input side.

When the distance between the VFD and motor is longer than 50 m, the parasitic capacitance between the long cable and ground may cause large leakage current, and overcurrent protection of the VFD may be frequently triggered. To prevent this from happening and avoid damage to the motor insulator, compensation must be made by adding an output reactor.

When a VFD is used to drive multiple motors, take the total length of the motor cables (that is, sum of the lengths of the motor cables) into account. When the total length is longer than 50 m, an output reactor must be added on the output side of the VFD. If the distance between the VFD and motor is 50 m to 150 m, select the reactor according to the following table. If the distance is longer than 150 m, contact INVT's technical support technicians.

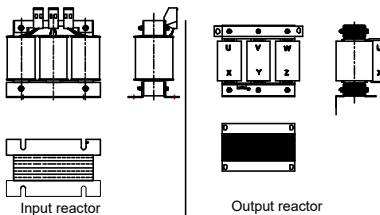

Model	Input reactor	Output reactor
GD20-0R4G-S2	/	/
GD20-0R7G-S2	/	/
GD20-1R5G-S2	/	/
GD20-2R2G-S2	/	/
GD20-0R4G-2	ACL2-1R5-4	OCL2-1R5-4
GD20-0R7G-2	ACL2-1R5-4	OCL2-1R5-4
GD20-1R5G-2	ACL2-004-4	OCL2-004-4
GD20-2R2G-2	ACL2-004-4	OCL2-004-4
GD20-004G-2	ACL2-5R5-4	OCL2-5R5-4
GD20-5R5G-2	ACL2-7R5-4	OCL2-7R5-4
GD20-7R5G-2	ACL2-015-4	OCL2-015-4
GD20-0R7G-4	ACL2-1R5-4	OCL2-1R5-4
GD20-1R5G-4	ACL2-1R5-4	OCL2-1R5-4
GD20-2R2G-4	ACL2-2R2-4	OCL2-2R2-4
GD20-004G-4	ACL2-004-4	OCL2-004-4
GD20-5R5G-4	ACL2-5R5-4	OCL2-5R5-4
GD20-7R5G-4	ACL2-7R5-4	OCL2-7R5-4
GD20-011G-4	ACL2-011-4	OCL2-011-4
GD20-015G-4	ACL2-015-4	OCL2-015-4
GD20-018G-4	ACL2-018-4	OCL2-018-4
GD20-022G-4	ACL2-022-4	OCL2-022-4
GD20-030G-4	ACL2-037-4	OCL2-037-4
GD20-037G-4	ACL2-037-4	OCL2-037-4
GD20-045G-4	ACL2-045-4	OCL2-045-4
GD20-055G-4	ACL2-055-4	OCL2-055-4

Model	Input reactor	Output reactor
GD20-075G-4	ACL2-075-4	OCL2-075-4
GD20-090G-4	ACL2-110-4	OCL2-110-4
GD20-110G-4	ACL2-110-4	OCL2-110-4

Note:

- ✧ The rated input voltage drop of input reactors is $2\% \pm 15\%$ while the rated output voltage drop of output reactors is $1\% \pm 15\%$.
- ✧ The preceding table describes external accessories. You need to specify the ones you choose when purchasing accessories.

C.6 Filters**C.6.1 C3 Filter model instruction**

FLT-P04003L-C-G

A
B
C
D
E
F
G

Field identifier	Field description
A	FLT: Name of the VFD filter series
B	Filter type P: Power input filter L: Output filter
C	Voltage class S2: AC 1PH 220V(-15%)–240V(+10%) 04: AC 3PH 380V (-15%)–440V(+10%)
D	3-digit development serial number. For example, 003 stands for the serial number of C3 filters in development
E	Filter performance L: General H: High-performance
F	Filter application environment A: Environment Category I (IEC61800-3) category C1 (EN 61800-3) B: Environment Category I (IEC61800-3) category C2 (EN 61800-3) C: Environment Category II (IEC61800-3) category C3 (EN 61800-3)
G	Lot No. G: Special for external C3 filter

C.6.2 C3 filter

Goodrive20 series 1PH 220V/3PH 380V 2.2kW and lower VFD models, 3PH 220V 0.75kW and lower VFD models can satisfy the requirements of IEC 61800-3 C3 as shown in the table

as follows. 3PH 380V 4kW and higher VFD models, 3PH 220V 1.5kW and higher VFD models can be set to satisfy the requirements of IEC 61800-3 C3 or not by jumper J10. (**Note:** Jumper J10 is put in the same bag with operation manual)

Note: Disconnect J10 when either of following situations occurs:

1. EMC filter is suitable for the neutral-grounding grid system. If it is used in IT grid system (neutral point is not grounded), disconnect J10;
2. During configuring residual current circuit-breaker, if tripping occurred during startup, disconnect J10.

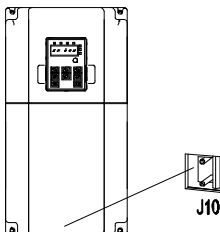

Interference filters on the input side can reduce the interference of VFDs (when used) on the surrounding devices.

Noise filters on the output side can decrease the radio noise caused by the cables between VFDs and motors and the leakage current of conducting wires.

INVT provides some of the filters for you to choose.

Model	Input filter
GD20-0R4G-S2	FLT-PS2004L-C-G
GD20-0R7G-S2	
GD20-1R5G-S2	
GD20-2R2G-S2	
GD20-0R4G-2	FLT-P04008L-C-G
GD20-0R7G-2	
GD20-0R7G-4	
GD20-1R5G-4	
GD20-2R2G-4	

Note:

- ✧ The input EMI meets the C3 requirements after an input filter is configured.
- ✧ The preceding table describes external accessories. You need to specify the ones you choose when purchasing accessories.

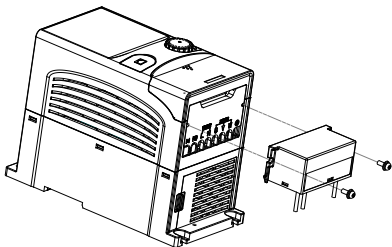
C.6.3 C3 filter installation instruction

Install the C3 filter according to the following steps.

1. Connect the filter cable to the corresponding input terminal of the VFD according to the label.
2. Fix the filter onto the VFD with M3*10 screws (as shown in above picture).

C.6.4 C2 Filter type instruction

FLT-P04016L-B
 A
 B
 C
 D
 E
 F

Field identifier	Field description
A	FLT: Name of the VFD filter series
B	Filter type P: Power input filter L: Output filter
C	Voltage class S2: AC 1PH 220V (-15%)–240V (+10%) 04: AC 3PH 380V (-15%)–440V (+10%)
D	3-digit code indicating the rated current. For example, 016 indicates 16A.
E	Filter performance L: General H: High-performance

Field identifier	Field description
F	Filter application environment A: Environment Category I (IEC61800-3) category C1 (EN 61800-3) B: Environment Category I (IEC61800-3) category C2 (EN 61800-3)

C.6.5 C2 filter model selection

Model	Input filter	Output filter
GD20-0R4G-S2	FLT-PS2010H-B	FLT-L04006L-B
GD20-0R7G-S2		
GD20-1R5G-S2	FLT-PS2025L-B	FLT-L04016L-B
GD20-2R2G-S2		
GD20-0R4G-2	FLT-P04006L-B	FLT-L04006L-B
GD20-0R7G-2		
GD20-1R5G-2	FLT-P04016L-B	FLT-L04016L-B
GD20-2R2G-2		
GD20-004G-2	FLT-P04032L-B	FLT-L04032L-B
GD20-5R5G-2		
GD20-7R5G-2	FLT-P04045L-B	FLT-L04045L-B
GD20-0R7G-4		
GD20-1R5G-4	FLT-P04006L-B	FLT-L04006L-B
GD20-2R2G-4		
GD20-004G-4		
GD20-5R5G-4	FLT-P04016L-B	FLT-L04016L-B
GD20-7R5G-4		
GD20-011G-4	FLT-P04032L-B	FLT-L04032L-B
GD20-015G-4		
GD20-018G-4	FLT-P04045L-B	FLT-L04045L-B
GD20-022G-4		
GD20-030G-4	FLT-P04065L-B	FLT-L04065L-B
GD20-037G-4		
GD20-045G-4	FLT-P04100L-B	FLT-L04100L-B
GD20-055G-4		
GD20-075G-4	FLT-P04150L-B	FLT-L04150L-B
GD20-090G-4		
GD20-110G-4	FLT-P04240L-B	FLT-L04240L-B

Note:



◇ The input EMI meets the C2 requirements after an input filter is configured.

- ✧ The preceding table describes external accessories. You need to specify the ones you choose when purchasing accessories.

C.7 Braking resistors

C.7.1 Braking resistor selection

When the VFD driving a high-inertia load decelerates or needs to decelerate abruptly, the motor runs in the power generation state and transmits the load-carrying energy to the DC circuit of the VFD, causing the bus voltage of the VFD to rise. If the bus voltage exceeds a specific value, the VFD reports an overvoltage fault. To prevent this from happening, you need to configure brake components.



	<ul style="list-style-type: none"> ✧ The design, installation, commissioning, and operation of the device must be performed by trained and qualified professionals. ✧ Follow all the "Warning" instructions during the operation. Otherwise, major physical injuries or property loss may be caused. ✧ Only qualified electricians are allowed to perform the wiring. Otherwise, damage to the VFD or brake components may be caused. ✧ Read the braking resistor instructions carefully before connecting them to the VFD. ✧ Connect braking resistors only to the terminals PB and (+). Do not connect them to other terminals. Otherwise, damage to the brake circuit and VFD and fire may be caused.
	<ul style="list-style-type: none"> ✧ Connect the brake components to the VFD according to the wiring diagram. If the wiring is not properly performed, damage to the VFD or other devices may be caused.

Model	Type of braking unit	Braking resistor at 100% of braking torque (Ω)	Consumed power of braking resistor			Min braking resistor (Ω)
			10% braking	50% braking	80% braking	
GD20-0R4G-S2	Built-in braking unit	361	0.06	0.30	0.48	42
GD20-0R7G-S2		192	0.11	0.56	0.90	42
GD20-1R5G-S2		96	0.23	1.10	1.80	30
GD20-2R2G-S2		65	0.33	1.70	2.64	21
GD20-0R4G-2		361	0.06	0.3	0.48	131
GD20-0R7G-2		192	0.11	0.56	0.9	93
GD20-1R5G-2		96	0.23	1.1	1.8	44
GD20-2R2G-2		65	0.33	1.7	2.64	44
GD20-004G-2		36	0.6	3	4.8	33

Model	Type of braking unit	Braking resistor at 100% of braking torque (Ω)	Consumed power of braking resistor			Min braking resistor (Ω)
			10% braking	50% braking	80% braking	
GD20-5R5G-2		26	0.75	4.13	6.6	25
GD20-7R5G-2		19	1.13	5.63	9	13
GD20-0R7G-4		653	0.11	0.56	0.90	240
GD20-1R5G-4		326	0.23	1.13	1.80	170
GD20-2R2G-4		222	0.33	1.65	2.64	130
GD20-004G-4		122	0.6	3	4.8	80
GD20-5R5G-4		89.1	0.75	4.13	6.6	60
GD20-7R5G-4		65.3	1.13	5.63	9	47
GD20-011G-4		44.5	1.65	8.25	13.2	31
GD20-015G-4		32.0	2.25	11.3	18	23
GD20-018G-4		27	3	14	22	19
GD20-022G-4		22	3	17	26	17
GD20-030G-4		17	5	23	36	17
GD20-037G-4		13	6	28	44	11.7
GD20-045G-4-B		10	7	34	54	8
GD20-055G-4-B		8	8	41	66	8
GD20-075G-4-B		6.5	11	56	90	6.4
GD20-090G-4-B		5.4	14	68	108	4.4
GD20-110G-4-B		4.5	17	83	132	4.4

Note:

- ✧ Select braking resistors according to the resistance and power data provided by our company.
- ✧ The braking resistor may increase the brake torque of the VFD. The preceding table describes the resistance and power for 100% brake torque, 10% brake usage, 50% brake usage, and 80% brake usage. You can select the brake system based on the actual operation conditions.

	✧ Do not use braking resistors whose resistance is lower than the specified minimum resistance. The VFD does not provide protection against overcurrent caused by resistors with low resistance.
	✧ In scenarios where brake is frequently implemented, that is, the brake usage is greater than 10%, you need to select a braking resistor with higher power as required by the operation conditions according to the preceding table.

C.7.2 Braking resistor installation

Braking resistor cables need to be shielded cables.

All resistors need to be installed in places with good cooling conditions. Braking resistors are connected externally.



- ✧ The materials near the braking resistor must be non-flammable. The surface temperature of the resistor is high. Air flowing from the resistor is of hundreds of degrees Celsius. Prevent any materials from coming into contact with the resistor.

Goodrive20 series VFDs need only external braking resistors. PB and (+) are the terminals for connecting braking resistors. Installation of braking resistors is shown in the following figure.

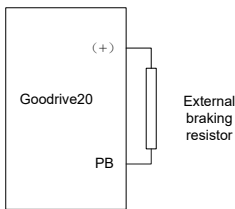

Appendix D Further information

D.1 Product and service queries

Should you have any queries about the product, contact the local INVT office. Provide the model and serial number of the product you query about. You can visit www.invt.com to find a list of INVT offices.

D.2 Feedback on INVT VFD manuals

Your comments on our manuals are welcome. Visit www.invt.com, directly contact online service personnel or choose **Contact Us** to obtain contact information.

D.3 Documents on the Internet

You can find manuals and other product documents in PDF format on the Internet. Visit www.invt.com and choose **Support > Download**.

www.nicsanat.com

021-87700210



invt

E-mail: overseas@invt.com.cn Website: www.invt.com

The products are owned by **Shenzhen INVT Electric Co.,Ltd.**

Two companies are commissioned to manufacture: (For product code, refer to the 2nd/3rd place of S/N on the name plate.)

Shenzhen INVT Electric Co.,Ltd. (origin code: 01)

Address: INVT Guangming Technology Building, Songbai Road,
Matian, Guangming District, Shenzhen, China

INVT Power Electronics (Suzhou) Co.,Ltd. (origin code: 06)

Address: No. 1 Kunlun Mountain Road, Science & Technology
Town, Gaoxin District, Suzhou, Jiangsu, China

Industrial Automation: HMI

Elevator Intelligent Control System

Energy & Power:

UPS

New Energy Vehicle Powertrain System

New Energy Vehicle Motor

PLC

Rail Transit Traction System

DCIM

New Energy Vehicle Charging System

VFD

Solar Inverter

Servo System

SVG



6 6 0 0 1 - 0 0 4 3 0

Copyright© INVT.

Manual information may be subject to change without prior notice.

202305 (V1.9)