



[CATALOGUE ESD-V2]

SINUS PENTA VARIABLE SPEED DRIVES

"Experience the Drive"



ELETRONICA
SANTERNO

INDUSTRIAL SWITCHGEAR & AUTOMATION SPECIALISTS



www.nicsanat.com

021-87700210



NHP's beginnings span back to 1968, when company founder, Nigel H Peck, had a vision to create a 100 % Australian owned and operated switchgear company. In a market dominated by large internationals, Nigel seized the opportunity to offer Australian customers unprecedented service and a wide range of quality products.



Head Office Complex - Richmond, Melbourne

At NHP, our focus on service and quality has enabled us to evolve from a small business of only 15 employees, to a prominent company with a 600-strong team and offices in 15 key locations throughout Australia and New Zealand.

Today, NHP sources quality products from over 50 specialist manufacturers worldwide based on the carefully researched needs and requirements of Australasian industry. Our product offerings encompass the key areas of:

- Motor Control
- Power Distribution
- Automation & Communication
- Control & Switching
- Safety & Protection
- Power Quality
- Hazardous Location
- Sensing & Detection
- Monitoring & Display
- Enclosures & Termination

NHP serves a diverse range of customers and specifiers: from electrical contractors, electrical wholesalers, original equipment manufacturers, engineering consultants, switchboard manufacturers to a variety of end users (e.g., mining, manufacturing, electrical and gas utilities and agriculture just to name a few).



National Distribution and Manufacturing Facility - Laverton, Melbourne

NHP goes to great lengths to deliver the highest level of service to all of our customer groups. We have recognised that it not only takes world class facilities to deliver this – but also a world class team of dedicated personnel.

With the largest product management, technical & engineering support and sales team in the Australasian electrical industry, we are fully equipped to provide customers with product and

application solutions, application troubleshooting advice, field service and after-sales support - NHP's quality 'value add'. Further more, our "Emergency Breakdown Service" is available 24 hours a day, 7 days a week, 365 days a year. Manufacturing facilities for emergency product conversion, adaptation and fast track manufacturing are available in all of our branches across Australia and New Zealand.

At NHP, our policy of "on time-in full" supply requires expansive stock holdings located close to customers, coupled with an extensive distribution network, ensuring that product is available when and where our customers need it. Our "National Distribution and Manufacturing Centre" in Laverton, located between the shipping terminal and airport, facilitates our ability to value add and customise as required to suit specific customers needs.

NHP's commitment to quality and service continues today and into the future and underpins our primary focus - passion for the customer.

Major Australian Offices



Sydney



Brisbane



Perth



Adelaide

New Zealand Offices



Auckland



Christchurch

History of Elettronica Santerno

Elettronica Santerno has an extensive history in the development of Variable Speed Drives. The company was founded in 1970 in Imola, located in the northern part of Italy. They began in the area of automation and control of industrial machines as well as alternative energy sources. Elettronica Santerno very soon moved into the area of power electronics. Large investment has been made into research and development to produce a drive that is innovative and competitive on the international market and continue to strive for advancement.

Today Elettronica Santerno develops, produces and markets, a full range of advanced power drive systems for industrial applications with power ratings up to 2MW and supply voltages up to 690 V. Elettronica Santerno is also a leader in the area of inverter systems for solar energy, wind energy and fuel cell technology.

Elettronica Santerno is a dominant player in the Italian market and is sold and supported in over 50 countries around the world.



Contents

	Page
SINUS PENTA overview	04
Typical application overload requirements	07
SINUS PENTA 380-415 V range and selection	08
Product identification	08
Options to suit 4T models	
Input and output chokes	10
EMC filter for First Environment	11
Semiconductor fuses	11
Brake resistors	12
SINUS PENTA 660-690 V range and selection	14
Options to suit 6T models	
Input and output chokes	14
General options	15
Mounting and connection	16
Keypad	18
Application	19
Specifications	20
Quick Selection charts	21





Variable speed drives for AC motors

Elettronica Santerno - SINUS PENTA

The SINUS PENTA is the latest fully featured drive to be released by Elettronica Santerno. This model boasts an extensive range of features to allow easy adaptation to a wide variety of applications while being easy to use, with a 4 line alphanumeric display with all text in plain English. All drives feature a full metal enclosure to provide robustness to suit the demands of industrial environments. In addition the metal enclosure minimises radiated EMC. The full range of drives up to 1 MW, 415 V and 2 MW, 690 V contain internal EMC filters complying with C-Tick Second Environment (Class A). With the addition of a ferrite core, the standard drive is also suitable for use in the First Environment (Class B) up to frame size S50. Further flexibility is also achieved with the inclusion of an IP 54 version for sizes up to S30 (132 kW). The IP 54 drive is a stand-alone wall mounted device which can be expanded to include a choke and additional pushbuttons and switches.

Features at a glance:

- Wide power and voltage range. 2.2-2010 kW, 380-690 V
- IP 20 and IP 54 standard solutions
- Selectable overload from 120 % to 200 %
- Built-in EMC filters to comply with  for the entire range
- 3 year warranty
- Five built-in control types (see below)
- 4 line alphanumeric display
- Extensive I/O configuration
- Fire mode solution to suit HVAC application
- Zero speed Fluxing (in VTC mode)
- Wide range of options available
- Integral brake chopper up to 132 kW
- ModBus RTU communications standard
- Optional fieldbus for all major protocols
- Cabinet solution available
- PC communication software with internet connectivity
- Extensive fault history record
- Safety stop function to IEC 61800-5-2 (draft)

Options

- EMC filter conforming to C-Tick first environment
- Dynamic braking resistors
- AC line choke (or DC choke on request)
- Output choke
- Semiconductor fuses
- Keypad mounting kit
- I/O expansion cards
- Encoder cards
- PC software and cables
- Communication and fieldbus cards

PENTA – Five integrated control functions

The SINUS PENTA incorporates five built-in control functions to accommodate a wide range of applications. This allows the one product to be adapted to many types of control philosophies and therefore provide the best performance for your application. These include the following functions.

IFD = Inverter Frequency Drive

This function offers an adjustable V/f pattern for general purpose applications.

VTC Open Loop = Vector Torque Control Open Loop

Through Sensorless Vector Direct Torque Control, the VTC function allows for improved torque performance without the need for feedback.

VTC Closed Loop = Vector Torque Control Closed Loop

The VTC function allows for fast dynamic response through encoder feedback for high torque or demanding applications.

FOC = Field Oriented Control

FOC is the ultimate in vector speed control providing high accuracy through encoder feedback for high torque precision and a wide speed range.

SYN = Synchronous

This control function provides a vector function for the control of brushless synchronous permanent magnet motors. This provides high torque accuracy combined with energy efficiency.

Variable speed drives for AC motors

User friendly interface

The 4 line alphanumeric keypad provides clear plain English text messaging for monitoring, parameter configuration and fault annunciation making the SINUS PENTA extremely user friendly. To simplify local operation, the keypad incorporates dedicated keys for start, stop, direction of rotation, local/remote selection, jog and reset. These keys are in addition to the standard programming keys. Status monitoring is made easy with the use of 11 LEDs to indicate conditions such as run, alarm, direction of rotation and local control active. The keypad has built-in intelligence to enable parameters to be uploaded and downloaded directly from the keypad.

To simplify commissioning and parameters set-up, the drive has three selectable access levels. Basic level is designed for simple applications, advanced is for applications requiring additional flexibility and engineering for applications requiring full configuration. The accessible parameters are minimised to suit the control function used and the access level selected. This allows the drive to have as few as 30 parameters for basic application or as many as 500 parameters for the most sophisticated applications.

Connectivity

Connectivity to a PC is possible using the REMOTE DRIVE software, which offers tools for the control of the drive, trending functions, setting and storage of parameters and online monitoring. REMOTE DRIVE allows the added benefit of providing a remote communication service by using a simple internet connection. The REMOTE DRIVE software and chat line allows fast communication between the inverter's user and our engineers.

Extensive connectivity is achieved by the use of a wide range of communication interfaces available. The drive incorporates Modbus-RTU / RS 485 as standard and with the addition of an option board, which can be mounted within the drive, all the other major fieldbus protocols can be accommodated such as Profibus DP, DeviceNet, CanBus, Interbus, Ethernet and many more currently in development.

Robust construction

The SINUS PENTA range are designed for robustness to meet the demands of industrial applications. The complete series includes a full metal enclosure for durability. The robustness extends to the full system. With a high level of quality and reliability as well as strict adherence to international standards such as ISO 9001, Elettronica Santerno is able to offer a three year warranty. This dependability provides the confidence that the drive can meet the challenge of demanding applications.

IP 54 solution

For many applications it is advantageous to install the drive directly on a machine, close to the motor, or on a wall. For this reason a higher enclosure protection is required. The SINUS PENTA is available in sizes up to 132 kW providing an economical and convenient solution. This solution is particularly suited to HVAC applications, irrigation, the food industry or applications requiring dispersed motor control. The robust IP 54 frame provides a removable gland plate, space to mount additional components if required and the ability to add additional controls to the front of the drive. For applications requiring the addition of a choke, a dedicated IP 54 option can be added to the drive construction.

Enclosed systems

By calling on the extensive range of options and products available an enclosed drive package can be tailored to suit the specific requirements of an application. The system can be customised to include options such as contactors, chokes, semiconductor fuses, dynamic braking solutions, communications options and many more. Please contact your NHP representative to discuss your specific requirements.



Flexible connection

The SINUS PENTA is designed for flexibility. This flexibility is incorporated into the extensive range of I/Os available. The SINUS PENTA incorporates as standard three programmable analog inputs and outputs. Also included are eight digital inputs, two digital outputs and two relay outputs. Inputs are programmable with the ability for dual assignment for activation of two functions simultaneously. Outputs incorporate both timing and logic for added flexibility. In addition, option boards are available to extend the number of I/Os. Having flexible inputs and outputs allows the SINUS PENTA to easily adapt to a wide range of control solutions.

Engineered solutions

For applications requiring more specialised solutions, Engineered systems can be developed. Solutions that are available include 12 or 18 pulse input configuration for reduced harmonic distortion and fully regenerative solutions incorporating an Active Front End to allow regenerated energy to be fed back to the supply. Special application software is also available to fulfil the requirements of specific applications such as multi-pump control, servo-diameters, axis control and positioning applications. These applications can be loaded into a standard SINUS PENTA drive. For further details on these specialised areas please contact NHP.

EMC requirements

EMI (Electromagnetic Interference) is normally caused by commutation in many devices. The high frequency interference can effect the operation of other devices and can create noises in measurement and communication systems. All these combined effects can create unexpected breakdowns. Two areas can be affected by the above: immunity and emissions.

AS 61800-3 is the product-specific drives standard that defines both immunity and emission levels required for those devices designed to operate in different environments. The SINUS PENTA range is designed to operate under different conditions, therefore they are all provided with a strong immunity against RFI that allows them to be reliable in all environments. Furthermore the complete range of drives in the SINUS PENTA series are C-Tick approved with integral EMC filters and conform to category C3 for the Second Environment. With the addition of a ferrite core, the drives can comply to category C1 for the First Environment. To simplify installation of analog signals, screen terminations are also included as standard.

Below are the AS 61800-3 2005 definitions on emission limits: (PDS = power drive system)

First Environment	Environment that includes domestic premises, or establishments directly connected without intermediate transformers to a low-voltage power supply network which supplies buildings used for domestic purposes.
Second Environment	Environment that includes all establishments other than those directly connected to a low-voltage power supply network which supplies buildings used for domestic purposes.
PDS of Category C1	PDS of rated voltage less than 1000 V, intended for use in the first environment.
PDS of Category C2	PDS of rated voltage less than 1000 V, which is neither a plug-in service nor a movable device and, when used in the first environment, is intended to be installed and commissioned only by a professional.
PDS of Category C3	PDS of rated voltage less than 1000 V, intended for use in the second environment.
PDS of Category C4	PDS of rated voltage equal to or above 1000 V, or rated current equal to or above 400 A, or intended for use in complex systems in the second environment.

How to select the right drive.

Follow the procedure below to select the drive that best suits your application.

- 1 Using the application overload table on page 7, identify the overload level that best suits your application.
- 2 From the selection table on page 8, choose the drive model that suits the overload level and your motor full load current.
- 3 Using the drive model, you can choose between IP 20 and IP 54 for drives up to frame S30 (132 kW). Select the correct catalogue number from the tables on page 9.
- 4 Select the options to suit your application requirements such as input or output chokes, semiconductor fuses, communication cards etc.

Variable speed drives - SINUS PENTA

Typical application overload requirements

Application	Light	Standard	Heavy	Strong	Application	Light	Standard	Heavy	Strong
Agitator		✓			Forming machine		✓	✓	
Atomiser	✓				Grinder	✓			
Axis control			✓	✓	Hoist/crane			✓	
Bottle washer	✓				Hydraulic power pack		✓		
Calenders		✓	✓		Injection moulding – screw		✓	✓	
Centrifuge		✓			Injection moulding – hydraulic power pack			✓	✓
Chipper		✓			Loom			✓	
Compressor – piston (loaded)			✓		Mill – ball			✓	
Compressor – piston (unloaded)		✓			Mill - hammer			✓	
Compressor – screw (loaded)		✓			Mill - roller			✓	
Compressor – screw (unloaded)	✓				Mixer		✓		
Conveyor – belt		✓	✓		Paint stirrer			✓	✓
Conveyor – roller		✓			Palletiser		✓		
Conveyor – screw			✓		Planer			✓	
Crusher – cone		✓			Press		✓	✓	
Crusher – jaw			✓		Pulper			✓	
Crusher – rotary		✓			Pump – bore	✓			
Crusher – vertical impact		✓			Pump – centrifugal	✓			
Debarker		✓			Pump – positive displacement	✓			
Drawplates		✓	✓		Pump – slurry	✓	✓		
Drill			✓	✓	Rotary table		✓		
Dryer		✓	✓		Sander		✓		
Dust collector	✓				Saw – band		✓		
Edger		✓			Saw – Circular		✓		
Elevator			✓	✓	Shears		✓	✓	
Extruder		✓			Separator		✓		
Fan – axial (damped)	✓				Shredder		✓		
Fan – axial (undamped)	✓				Slicer		✓	✓	
Fan – centrifugal (damped)	✓				Spinner		✓		
Fan – centrifugal (undamped)	✓				Tumbler		✓	✓	
Fan – high pressure	✓				Vibrating screen			✓	
					Washer – industrial		✓		
					Winding/Unwinding		✓	✓	

Light up to 120 % overload
Standard up to 140 % overload
Heavy up to 175 % overload
Strong up to 200 % overload

If your application is not listed above please contact NHP to assist you with correct selection.

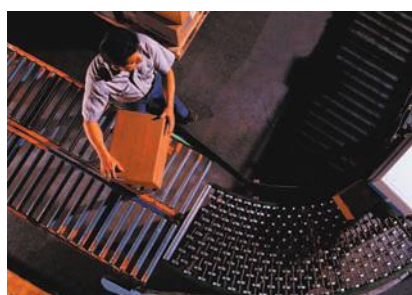

SINUS PENTA Range and selection

Power supply 380-415 V AC

Size	Cat. No.	Light		Standard		Heavy		Strong		I _{nom} A	I _{max} A
		kW	A	kW	A	kW	A	kW	A		
S05 ¹⁾	SP 0005 4TBA2K2	4.5	9	4	8.4	3	6.4	2.2	4.9	10.5	11.5
	SP 0007 4TBA2K2	5.5	11.2	4.5	9	4	8.4	3	6.4	12.5	13.5
	SP 0009 4TBA2K2	7.5	14.5	5.5	11.2	4.5	9	4	8.4	16.5	17.5
	SP 0011 4TBA2K2	7.5	14.8	7.5	14.8	5.5	11.2	4.5	9	16.5	21
	SP 0014 4TBA2K2	7.5	14.8	7.5	14.8	7.5	14.8	5.5	11.2	16.5	25
S10 ¹⁾	SP 0016 4TBA2K2	11	21	9.2	17.9	9.2	17.9	7.5	14.8	26	30
	SP 0017 4TBA2K2	15	29	11	21	9.2	17.9	7.5	14.8	30	32
	SP 0020 4TBA2K2	15	29	15	29	11	21	9.2	17.9	30	36
	SP 0025 4TBA2K2	22	41	18.5	35	15	29	11	21	41	48
	SP 0030 4TBA2K2	22	41	22	41	18.5	35	15	29	41	56
S15 ¹⁾	SP 0038 4TBA2K2	30	55	25	46	25	46	22	41	65	75
	SP 0040 4TBA2K2	37	67	30	55	25	46	22	41	72	75
	SP 0049 4TBA2K2	45	80	37	67	30	55	25	46	80	96
S20 ¹⁾	SP 0060 4TBA2K2	50	87	45	80	37	67	30	55	88	112
	SP 0067 4TBA2K2	55	98	55	98	45	80	32	59	103	118
	SP 0074 4TBA2K2	65	114	65	114	50	87	37	67	120	144
	SP 0086 4TBA2K2	75	133	75	133	55	98	45	80	135	155
S30 ¹⁾	SP 0113 4TBA2K2	100	180	90	159	75	133	55	98	180	200
	SP 0129 4TBA2K2	110	191	100	180	80	144	65	114	195	215
	SP 0150 4TBA2K2	120	212	110	191	90	159	75	133	215	270
	SP 0162 4TBA2K2	132	228	132	228	110	191	90	159	240	290
S40	SP 0179 4TXA2K2	160	273	150	264	120	212	100	180	300	340
	SP 0200 4TXA2K2	200	341	160	273	132	228	110	191	345	365
	SP 0216 4TXA2K2	220	375	200	341	160	273	120	212	375	430
	SP 0250 4TXA2K2	230	390	220	375	185	321	132	228	390	480
S50 ²⁾	SP 0312 4TXA2K0	280	480	250	421	220	375	185	321	480	600
	SP 0366 4TXA2K0	315	528	280	480	250	421	200	341	550	660
	SP 0399 4TXA2K0	375	621	315	528	280	480	220	375	630	720
S60 ²⁾	SP 0457 4TXA2K0	400	680	400	680	315	528	280	480	720	880
	SP 0524 4TXA2K0	450	765	450	765	355	589	315	528	800	960
S65 ²⁾	SP 0598 4TXA2K0	500	841	500	841	400	680	355	589	900	1100
	SP 0748 4TXA2K0	560	939	560	939	500	841	400	680	1000	1300
	SP 0831 4TXA2K0	710	1200	630	1080	560	939	450	765	1200	1440
S75 ²⁾	SP 0964 4TXA2K0	900	1480	800	1334	710	1200	560	939	1480	1780
	SP 1130 4TXA2K0	1000	1646	900	1480	800	1334	710	1200	1700	2040
	SP 1296 4TXA2K0	1170	1950	1100	1874	900	1480	800	1334	1950	2340

Notes: ¹⁾ Available in IP 54 version

²⁾ Require input and output chokes

³⁾ NHP standard model

I_{nom} = Inverter nominal continuous current rating

I_{max} = Inverter maximum current for 120 sec
every 20 min up to S30 and 60 sec
every 10 min all other sizes

Light up to 120 % overload

Standard up to 140 % overload

Heavy up to 175 % overload

Strong up to 200 % overload

Cat. No. - Product Identification

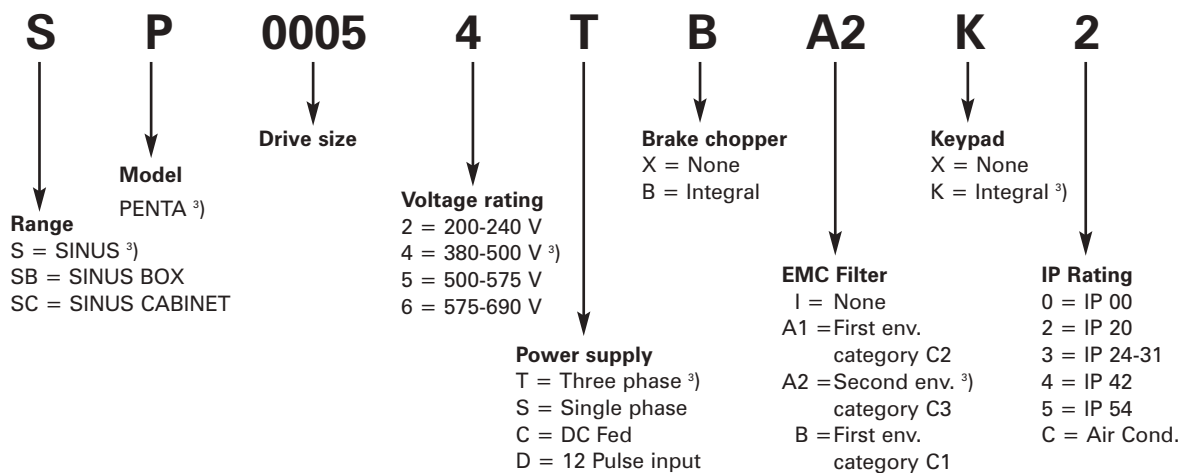

Ordering details

SINUS PENTA - 380-415 V IP 20 / IP 00

Size	Cat. No.	Dimensions (mm)			IP Rating	Weight (kg)	Losses at I _{nom} (W)
		W	H	D			
S05	SP 0005 4TBA2K2	170	340	175	IP 20	7	215
	SP 0007 4TBA2K2				IP 20	7	240
	SP 0009 4TBA2K2				IP 20	7	315
	SP 0011 4TBA2K2				IP 20	7	315
	SP 0014 4TBA2K2				IP 20	7	315
S10	SP 0016 4TBA2K2	215	391	216	IP 20	11.5	350
	SP 0017 4TBA2K2				IP 20	11.5	380
	SP 0020 4TBA2K2				IP 20	11.5	420
	SP 0025 4TBA2K2				IP 20	11.5	525
	SP 0030 4TBA2K2				IP 20	11.5	525
	SP 0035 4TBA2K2				IP 20	11.5	525
S15	SP 0038 4TBA2K2	225	466	331	IP 20	22.5	750
	SP 0040 4TBA2K2				IP 20	22.5	820
	SP 0049 4TBA2K2				IP 20	22.5	950
S20	SP 0060 4TBA2K2	279	610	332	IP 20	36	1050
	SP 0067 4TBA2K2				IP 20	36	1250
	SP 0074 4TBA2K2				IP 20	36	1350
	SP 0086 4TBA2K2				IP 20	36	1500
S30	SP 0113 4TBA2K2	302	748	421	IP 20	51	2150
	SP 0129 4TBA2K2				IP 20	51	2300
	SP 0150 4TBA2K2				IP 20	51	2450
	SP 0162 4TBA2K2				IP 20	51	2700
S40	SP 0179 4TXA2K2	630	880	381	IP 20	112	3200
	SP 0200 4TXA2K2				IP 20	112	3650
	SP 0216 4TXA2K2				IP 20	112	4100
	SP 0250 4TXA2K2				IP 20	112	4250
S50	SP 0312 4TXA2K0	666	1000	421	IP 00	148	4900
	SP 0366 4TXA2K0				IP 00	148	5600
	SP 0399 4TXA2K0				IP 00	148	6400
S60	SP 0457 4TXA2K0	890	1310	530	IP 00	260	7400
	SP 0524 4TXA2K0				IP 00	260	8400
S65	SP 0598 4TXA2K0	980	1400	560	IP 00	440	9750
	SP 0748 4TXA2K0				IP 00	440	10750
	SP 0831 4TXA2K0				IP 00	440	12900
S75	SP 0964 4TXA2K0	1980	1400	560	IP 00	880	15400
	SP 1130 4TXA2K0				IP 00	880	17000
	SP 1296 4TXA2K0				IP 00	880	18600



S20

S05

SINUS PENTA - 380-415 V IP 54

Size	Cat. No.	Dimensions (mm)			IP Rating	Weight (kg)	Losses at I _{nom} (W)
		W	H	D			
S05	SP 0005 4TBA2K5	214	577	227	IP 54	15.7	215
	SP 0007 4TBA2K5				IP 54	15.7	240
	SP 0009 4TBA2K5				IP 54	15.7	315
	SP 0011 4TBA2K5				IP 54	15.7	315
	SP 0014 4TBA2K5				IP 54	15.7	315
S10	SP 0016 4TBA2K5	250	622	268	IP 54	22.3	350
	SP 0017 4TBA2K5				IP 54	22.3	380
	SP 0020 4TBA2K5				IP 54	22.3	420
	SP 0025 4TBA2K5				IP 54	23.3	525
	SP 0030 4TBA2K5				IP 54	23.3	525
	SP 0035 4TBA2K5				IP 54	23.3	525
S15	SP 0038 4TBA2K5	288	715	366	IP 54	40	750
	SP 0040 4TBA2K5				IP 54	40	820
	SP 0049 4TBA2K5				IP 54	40	950
S20	SP 0060 4TBA2K5	339	842	366	IP 54	54.2	1050
	SP 0067 4TBA2K5				IP 54	54.2	1250
	SP 0074 4TBA2K5				IP 54	57	1350
	SP 0086 4TBA2K5				IP 54	57	1500
S30	SP 0113 4TBA2K5	359	1008	460	IP 54	76	2150
	SP 0129 4TBA2K5				IP 54	76	2300
	SP 0150 4TBA2K5				IP 54	76	2450
	SP 0162 4TBA2K5				IP 54	76	2700



S30 IP54

S05 IP 54

Options to suit 4T SINUS PENTA models

Input and output choke - 380-415 V

Input choke:

When installing a VSD of size S40 (230 kW) or less, a choke should be used to;

- Reduce harmonics
- Improve wave shape
- Reduce the impact of mains instability
- Protect against the effects of switching devices on the mains



For sizes S50 and above, it is recommended to always use a line reactor unless a dedicated transformer is used. DC chokes are available on request.

Output choke:

When installing a VSD of size S40 (230 kW) or less, an output choke should be used in the following situations;

- Long motor output cables
- When multiple motors are connected to one VSD
- Reduce reflected waves
- Reduce dV/dt to the motor

For sizes S50 and above, it is recommended to always use an output reactor.

Ordering details 380-415 V Chokes IP 20/ IP 00

To suit size SP...4T...	Suitable for Input/Output	Rating		Dimensions			IP rating	Cat. No.	Weight	Losses at I _{nom} (W)
		A	mH	L	H	D				
0005	Input & Output	11	2.0	120	135	80	IP 20	IM0126004	2.8	29
0007-0014	Input & Output	17	1.27	120	135	90	IP 20	IM0126044	3	48
0016-0020	Input & Output	32	0.7	150	175	105	IP 20	IM0126084	5	70
0025-0035	Input & Output	43	0.7	150	175	125	IP 20	IM0126124	6	96
0038-0060	Input & Output	92	0.24	180	160	155	IP 00	IM0126164	10	183
0067-0086	Input & Output	142	0.16	240	210	170	IP 00	IM0126204	24.5	342
0113-0162	Input & Output	252	0.09	240	210	220	IP 00	IM0126244	24.5	342
0179-0200	Input & Output	362	0.061	300	260	220	IP 00	IM0126284	37	407
0216-0250	Input & Output	410	0.054	300	290	230	IP 00	IM0126324	53	500
0321-0399	Input & Output	662	0.033	300	290	230	IP 00	IM0126364	53	500
0457-0598	Input & Output	945	0.023	300	320	260	IP 00	IM0126404	67	752
0748-0831	Input & Output	1260	0.018	300	320	260	IP 00	IM0126444	85	1070
0964	Input	2 x 945	0.023	300	320	260	IP 00	2 x IM0126404	2 x 67	2 x 752
0964	Output	6 x 950	0.024	TBA	TBA	TBA	IP 00	6 x IM0140674	TBA	6 x 250
1130-1296	Input (1130)	2 x 945	0.023	300	320	260	IP 00	2 x IM0126404	2 x 67	2 x 752
1130-1296	Input (1296)	2 x 1260	0.018	300	320	260	IP 00	2 x IM0126444	2 x 82	2 x 1070
1130-1296	Output	6 x 1250	0.018	TBA	TBA	TBA	IP 00	6 x IM0140774	TBA	6 x 350

¹⁾ Input choke only ²⁾ Output choke only

IP 54 Choke

A separate choke is available in IP 54, specifically designed to integrate into the IP 54 VSD solution. This choke fits under the drive to allow for connections. The choke can be used on either the input or output side of the drive.



Ordering details 380-415 V Chokes IP 54

To suit size SP...4T...	Suitable for Input/Output	Rating		Dimensions			IP rating	Cat. No.	Weight	Losses at I _{nom} (W)
		A	mH	W	H	P				
0005	Input & Output	11	2.0	250	270	180	IP 54	ZZ0112010	6.5	29
0007-0014	Input & Output	17	1.27	250	270	180	IP 54	ZZ0112020	7.0	48
0016-0020	Input & Output	32	0.7	250	270	180	IP 54	ZZ0112030	9.5	70
0025-0035	Input & Output	43	0.7	250	270	180	IP 54	ZZ0112040	10	96
0038-0060	Input & Output	92	0.24	288	310	250	IP 54	ZZ0112050	14.5	183
0067-0086	Input & Output	142	0.16	300	357	280	IP 54	ZZ0112060	26	342
0113-0162	Input & Output	252	0.09	300	357	280	IP 54	ZZ0112070	32.5	342

Motor wiring with screened cables
2-4-6 pole motors

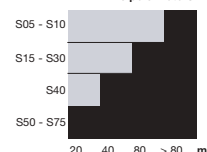

Motor wiring with unscreened cables
2-4-6 pole motors

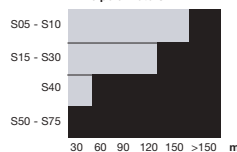

EMC Filter for first environment

When used in conjunction with the internal A2 (second environment) EMC filter, this ferrite allows the VSD to be suitable for use in the First Environment (class B) for residential and commercial use. The ferrite is installed between the output of the VSD and the motor by passing the three phases through the centre of the ferrite.

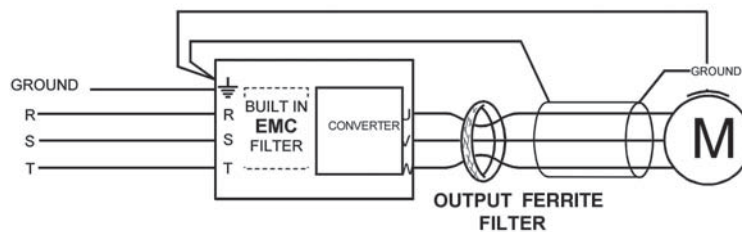

To suit size SP---4T...	Rating	Diameter (mm)		Cat. No.
		Outer	Inner	
0005-0020	2 x K618, 32 A	25	15	AC1810302
0025-0038	2 x K674, 64 A	35	25	AC1810402
0040-0086	3 x K40, 155 A	60	40	AC1810603
0113	4 x K40, 180 A	60	40	AC1810604
0129-0250	4 x A84, 375 A	105	65	AC1811004
0312-0399	2 x A705, 630 A	140	105	AC1811202

Semiconductor fuses

Semiconductor fuses are recommended to protect the rectifier in the event of a short circuit. Standard fuses and circuit breakers alone are generally not adequate due to slower switch-off times.

To suit size SP---4T...	Rating	Dimensions (mm) (3/6 fuses incl. base)			Cat. No. ¹⁾
		W	H	D	
0009-0011	25 A	146	120	68	20 412 04 25
0014-0020	40 A	146	120	68	20 412 20 40
0025-0030	63 A	146	120	68	20 412 20 63
0035-0049	100 A	146	120	68	20 412 20 100
0060-0067	125 A	146	120	68	20 412 20 125
0074	160 A	146	120	68	20 412 20 160
0086	200 A	146	120	68	20 412 20 200
0113-0129	250 A	146	120	68	20 412 20 250
0150	315 A	146	120	68	20 412 20 315
0162-0200	400 A	146	120	68	20 412 20 400
0216	550 A	205	258	104	20 622 32 550
0250	700 A	205	258	104	20 622 32 700
0312-0399	800 A	205	258	104	20 622 32 800
0457	1000 A	205	258	104	20 622 32 1000
0524	1250 A	205	258	104	20 622 32 1250
0598-0748	1400 A	205	258	115	20 632 32 1400
0831	2 x 800 A	410	258	115	20 632 32 800 ²⁾
0964	2 x 1000 A	410	258	104	20 632 32 1000 ²⁾
1130	2 x 1250 A	410	258	104	20 632 32 1250 ²⁾
1269	2 x 1400 A	410	258	115	20 632 32 1400 ²⁾

Accessories

Description	To suit size SP---4T...	Cat. No.
Fuse base (1 per fuse, 3 required per drive)	0005-0200	21 189 01
Fuse base (1 per fuse, 3/6 required per drive)	0216-+	21 313 02
Auxiliary switch (1 per fuse)	0005-0200	28 002 02
Auxiliary switch (1 per fuse)	0216-+	28 001 04

Notes: ¹⁾ One per fuse per phase.
²⁾ 2 fuses per phase.



Brake resistors

Dynamic braking allows a standard VSD to fully control the operation of the motor even when the motor acts as a generator. This can be the case when fast stopping times are required or the load has a high inertia. The use of a brake resistor allows the energy produced to be consumed to avoid an alarm condition.



Drives up to frame S30 (132 kW) come standard with an integral brake module. In order to utilise this braking function, an external resistor is required. For larger sizes an external brake unit (BU200) is required.

The resistors in the table below are rated for full braking but need to be selected based on the required duty cycle of operation. There are three selections possible. These are 10%, 20% and 50% to cover the wide range of applications and requirements.

Brake resistor selection guide for 380-500 V AC supply voltage

Size	Inverter model		Min resist Ω	Duty cycle 10%		Duty cycle 20%		Duty cycle 50%	
	SINUS PENTA			Rating	Cat. No.	Rating	Cat. No.	Rating	Cat. No.
S05	0005	4T BA2K2	50	75Ω - 550W	RE3063750	50Ω - 1100W	RE3083500	50Ω - 4000W	RE3503500
	0007	4T BA2K2	50	75Ω - 550W	RE3063750	50Ω - 1100W	RE3083500	50Ω - 4000W	RE3503500
	0009	4T BA2K2	50	50Ω - 1100W	RE3083500	50Ω - 1100W	RE3083500	50Ω - 4000W	RE3503500
	0011	4T BA2K2	50	50Ω - 1100W	RE3083500	50Ω - 1500W	RE3093500	50Ω - 4000W	RE3503500
	0014	4T BA2K2	50	50Ω - 1100W	RE3083500	50Ω - 1500W	RE3093500	50Ω - 4000W	RE3503500
S10	0016	4T BA2K2	50	50Ω - 1500W	RE3093500	50Ω - 2200W	RE3113500	50Ω - 8000W	RE3783500
	0017	4T BA2K2	50	50Ω - 1500W	RE3093500	50Ω - 2200W	RE3113500	50Ω - 8000W	RE3783500
	0020	4T BA2K2	50	50Ω - 1500W	RE3093500	50Ω - 4000W	RE3483500	50Ω - 8000W	RE3783500
	0025	4T BA2K2	20	25Ω - 1800W	RE3103250	25Ω - 4000W	RE3483250	20Ω - 12000W	RE4053200
	0030	4T BA2K2	20	25Ω - 1800W	RE3103250	25Ω - 4000W	RE3483250	20Ω - 12000W	RE4053200
	0035	4T BA2K2	20	25Ω - 1800W	RE3103250	25Ω - 4000W	RE3483250	20Ω - 12000W	RE4053200
S15	0038	4T BA2K2	15	15Ω - 4000W	RE3483150	15Ω - 4000W	RE3483150	15Ω - 16000W	RE4163150
	0040	4T BA2K2	15	15Ω - 4000W	RE3483150	15Ω - 4000W	RE3483150	15Ω - 16000W	RE4163150
	0049	4T BA2K2	10	15Ω - 4000W	RE3483150	10Ω - 8000W	RE3763100	15Ω - 16000W	RE4163150
S20	0060	4T BA2K2	10	10Ω - 8000W	RE3763100	10Ω - 8000W	RE3763100	10Ω - 24000W	RE4293100
	0067	4T BA2K2	10	10Ω - 8000W	RE3763100	10Ω - 12000W	RE4023100	10Ω - 24000W	RE4293100
	0074	4T BA2K2	8.5	10Ω - 8000W	RE3763100	10Ω - 12000W	RE4023100	10Ω - 24000W	RE4293100
	0086	4T BA2K2	8.5	10Ω - 8000W	RE3763100	10Ω - 12000W	RE4023100	10Ω - 24000W	RE4293100
S30	0113	4T BA2K2	6	6.6Ω - 12000W	RE4022660	2 x 3.3Ω ²⁾ - 8000W	2 x RE3762330	6Ω - 48000W	RE4452600
	0129	4T BA2K2	6	6.6Ω - 12000W	RE4022660	2 x 3.3Ω ²⁾ - 8000W	2 x RE3762330	6Ω - 48000W	RE4452600
	0150	4T BA2K2	5	6.6Ω - 12000W	RE4022660	2 x 10Ω ³⁾ - 12000W	2 x RE4023100	5Ω - 64000W	RE4552500
	0162	4T BA2K2	5	6.6Ω - 12000W	RE4022660	2 x 10Ω ³⁾ - 12000W	2 x RE4023100	5Ω - 64000W	RE4552500
S40 ¹⁾	0179	4T XA2K2	2/3 BU200	2 x 10Ω - 8000W	2 x RE3763100	2 x 6.6Ω - 12000W	2 x RE4022660	3 x 10Ω - 24000W	3 x RE4293100
	0200	4T XA2K2	2/3 BU200	2 x 6.6Ω - 12000W	2 x RE4022660	2 x 6.6Ω - 12000W	2 x RE4022660	3 x 10Ω - 24000W	3 x RE4293100
	0216	4T XA2K2	2/3 BU200	2 x 6.6Ω - 12000W	2 x RE4022660	3 x 6.6Ω - 12000W	3 x RE4022660	3 x 10Ω - 24000W	3 x RE4293100
	0250	4T XA2K2	2/3/4 BU200	2 x 6.6Ω - 12000W	2 x RE4022660	3 x 6.6Ω - 12000W	3 x RE4022660	4 x 10Ω - 24000W	4 x RE4293100
S50 ¹⁾	0312	4T XA2K0	3/4 BU200	3 x 6.6Ω - 12000W	3 x RE4022660	4 x 6.6Ω - 12000W	4 x RE4022660	4 x 10Ω - 24000W	4 x RE4293100
	0366	4T XA2K0	3/4/6 BU200	3 x 6.6Ω - 12000W	3 x RE4022660	4 x 6.6Ω - 12000W	4 x RE4022660	6 x 10Ω - 24000W	6 x RE4293100
	0399	4T XA2K0	3/4/6 BU200	3 x 6.6Ω - 12000W	3 x RE4022660	4 x 6.6Ω - 12000W	4 x RE4022660	6 x 10Ω - 24000W	6 x RE4293100
S60 ¹⁾	0457	4T XA2K0	3/5/8 BU200	3 x 6.6Ω - 12000W	3 x RE4022660	5 x 10Ω - 12000W	5 x RE4023100	8 x 10Ω - 24000W	8 x RE4293100
	0524	4T XA2K0	4/5/10 BU200	4 x 6.6Ω - 12000W	4 x RE4022660	5 x 10Ω - 12000W	5 x RE4023100	10 x 10Ω - 24000W	10 x RE4293100
S65	0598	4T XA2K0	BU1440	1.2Ω - 64000W	RE4562120	2 x 2.4Ω - 64000W	2 x RE4562240	4 x 1.2Ω - 64000W	4 x RE4562120
	0748	4T XA2K0	BU1440	1.2Ω - 64000W	RE4562120	2 x 2.4Ω - 64000W	2 x RE4562240	4 x 1.2Ω - 64000W	4 x RE4562120
	0831	4T XA2K0	BU1440	2 x 1.6Ω - 48000W	2 x RE4462160	2 x 1.6Ω - 64000W	2 x RE4562160	4 x 0.8Ω - 64000W	4 x RE4561800

Notes: ¹⁾ A brake unit BU200 is required for each resistor used.

²⁾ Series connection.

³⁾ Parallel connection.

Ordering details - Brake resistors

Rating Ω w	Dimensions (mm)			IP Rating	Cat. No.	Max. Cont. On Time
	L	H	D			
75 - 550	195	174	13	IP 55	RE3063750	2.25
50 - 1100	320	95	30	IP 55	RE3083500	5
50 - 1500	320	120	40	IP 54	RE3093500	4.5
25 - 1800	380	120	40	IP 54	RE3103250	3
50 - 2200	380	190	67	IP 54	RE3113500	8
50 - 4000	100	250	620	IP 20	RE3483500	90
25 - 4000	100	250	620	IP 20	RE3483250	20
15 - 4000	100	250	620	IP 20	RE3483150	5
10 - 8000	160	250	620	IP 20	RE3763100	2
3.3 - 8000	160	250	620	IP 20	RE3762330	5
10 - 12000	200	250	620	IP 20	RE4023100	12
6.6 - 12000	200	250	620	IP 20	RE4022660	5
50 - 4000	320	375	650	IP 23	RE3503500	30
50 - 8000	380	375	650	IP 23	RE3783500	50
20 - 12000	460	375	650	IP 23	RE4053200	50
15 - 16000	550	375	650	IP 23	RE4163150	58
10 - 24000	750	375	650	IP 23	RE4293100	62
6.6 - 32000	990	375	650	IP 23	RE4362660	62
6 - 48000	750	730	650	IP 23	RE4452600	90
1.6 - 48000	TBA	TBA	TBA	IP 23	RE4462160	TBA
5 - 64000	990	730	650	IP 23	RE4552500	106
2.4 - 64000	TBA	TBA	TBA	IP 23	RE4562240	TBA
1.6 - 64000	TBA	TBA	TBA	IP 23	RE4562180	TBA
1.2 - 64000	TBA	TBA	TBA	IP 23	RE4562120	TBA
0.8 - 64000	TBA	TBA	TBA	IP 23	RE4561800	TBA



Brake units and accessories

Description	To suit	Cat. No.
Adjustable thermal probe	IP 23 resistors	WW0030460
BU200 - Braking unit	S40 - S60	ZZ0063010
BU1440 - Braking unit	S65+	ZZ0063040

How to select the brake resistor.

Follow the procedure below to select the resistor that best suits your application.

- From the following formula and graph (right) calculate the Duty cycle of your application.

$$\text{Duty cycle (\%)} = \frac{100 \times \text{braking time}}{\text{cycle time}}$$

- From the calculated Duty cycle select the resistor from the table on page 12. Use the column with the Duty cycle greater than or equal to the calculated value.
- Check the braking time is less than or equal to the resistors' maximum on time rating as shown in the table above.

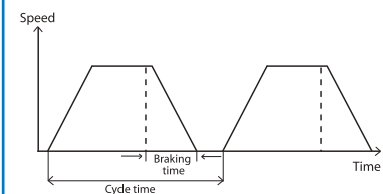

SINUS PENTA 660-690 V range and selection

Power supply 660-690 V AC

Size	Cat. No.	Light		Standard		Heavy		Strong		I _{nom} A	I _{max} A
		kW	A	kW	A	kW	A	kW	A		
S40		Development complete. Details coming soon.									
S50		Contact NHP for further details.									
S60		Contact NHP for further details.									
S65	SP 0250 6TXA2KO	400	390	375	360	330	328	280	278	390	480
	SP 0312 6TXA2KO	500	480	450	443	400	390	355	341	480	600
	SP 0366 6TXA2KO	560	544	500	480	450	443	375	360	550	660
	SP 0399 6TXA2KO	630	626	560	544	500	480	400	390	630	720
	SP 0457 6TXA2KO	710	696	630	626	560	544	500	480	720	880
	SP 0524 6TXA2KO	800	773	710	696	630	626	560	544	800	960
	SP 0598 6TXA2KO	900	858	900	858	710	696	630	626	900	1100
	SP 0748 6TXA2KO	1000	954	1000	954	900	858	800	773	1000	1300
S70	SP 0831 6TXA2KO	1240	1200	1100	1086	1000	954	900	858	1200	1440
S75	SP 0964 6TXA2KO	1530	1480	1410	1369	1220	1187	1000	954	1480	1780
S80	SP 1130 6TXA2KO	1750	1700	1620	1569	1400	1360	1100	1086	1700	2040
	SP 1296 6TXA2KO	2010	1950	1850	1800	1610	1560	1380	1337	1950	2340

Light up to 120 % overload
Standard up to 140 % overload

Heavy up to 175 % overload
Strong up to 200 % overload

I_{nom} = Inverter nominal continuous current rating

I_{max} = Inverter maximum current for 60 sec every 10 min

Ordering details – SINUS PENTA - 660-690 V IP 00

Size	Cat. No.	Dimensions (mm)			IP Rating	Weight (kg)	Losses at I _{nom} (W)
		W	H	D			
S40		Development complete. Details coming soon.					
S50		Contact NHP for further details.					
S60		Contact NHP for further details.					
S65	SP 0250 6TXA2KO	980	1400	560	IP 00	440	5000
	SP 0312 6TXA2KO				IP 00	440	6100
	SP 0366 6TXA2KO				IP 00	440	6900
	SP 0399 6TXA2KO				IP 00	440	8000
	SP 0457 6TXA2KO				IP 00	440	9150
	SP 0524 6TXA2KO				IP 00	440	9800
	SP 0598 6TXA2KO				IP 00	440	11250
	SP 0748 6TXA2KO				IP 00	440	12450
S70	SP 0831 6TXA2KO	1230	1400	560	IP 00	580	14900
S75	SP 0964 6TXA2KO	1980	1400	560	IP 00	880	17600
S80	SP 1130 6TXA2KO	2230	1400	560	IP 00	990	21900
	SP 1296 6TXA2KO				IP 00	990	24000



S65

Options to suit SINUS PENTA 6T models

Input Chokes - 660-690 V

Applicable size SP---6T XA2KO	Rating		Dimensions (mm)			IP Rating	Cat. No.	Weight (kg)	Losses at I _{nom} (W)
	A	mH	L	H	P				
0250	410	0.093	300	290	220	IP 00	IM0127324	52	581
0312-0399	662	0.058	360	310	250	IP 00	IM0127364	79	746
0457-0598	945	0.040	360	390	270	IP 00	IM0127404	88	1193
0748	1260	0.030	420	410	290	IP 00	IM0127444	110	1438
0831	2 x 662	0.058	360	310	250	IP 00	2 x IM0127364	2 x 79	2 x 746
0964	2 x 945	0.040	360	390	270	IP 00	2 x IM0127404	2 x 88	2 x 1193
1130	3 x 662	0.058	360	310	250	IP 00	3 x IM0127364	3 x 79	3 x 746
1296	3 x 945	0.040	360	390	270	IP 00	3 x IM0127404	3 x 88	3 x 1193

Output Chokes - 660-690 V

Applicable size SP---6T XA2KO	Rating		Dimensions (mm)			IP Rating	Cat. No.	Weight (kg)	Losses at I _{nom} (W)
	A	mH	L	H	P				
0250	410	0.093	300	290	220	IP 00	IM0127324	52	581
0312-0399	662	0.058	360	310	250	IP 00	IM0127364	79	746
0457-0598	945	0.040	360	390	270	IP 00	IM0127404	88	1193
0748-0831	1260	0.030	420	410	290	IP 00	IM0127444	110	1438
0963-1130	6 x 900	0.058	TBA	TBA	TBA	IP 00	6 x IM0141724	TBA	6 x 400
1296	6 x 1050	0.040	TBA	TBA	TBA	IP 00	6 x IM0141784	TBA	6 x 500

SINUS PENTA - Options

Description	Cat. No.
Remote mounting kits	
Remote mounting kit for keypad to IP 55 with a 3 m cable	ZZ0095699
Remote mounting kit for keypad to IP 55 with a 5 m cable	ZZ0095700
Heatsink segregation kit for frame S05	
Heatsink segregation kit for frame S10	ZZ0095210 ZZ0083802
I/O Expansion cards	
ES 847 I/O Expansion card (required for some special application software) 8 digital inputs, 6 digital outputs and 4 analog inputs or PT100 This card mounts in the I/O slot within the drive.	ZZ0101812
ES 870 I/O Expansion card 12 digital inputs and 6 relay outputs This card mounts in the I/O slot within the drive.	ZZ0101840
Communication option cards	
ES 822 Insulated card for RS 232 and/or RS 485 communication and is suggested for Modbus networks. This card mounts in the communications slot within the drive.	ZZ0095850
These cards mount in the communications slot within the drive	
Profibus DP card (kit hardware and software)	ZZ4600040
DeviceNet card (kit hardware and software)	ZZ4600050
Interbus card (kit hardware and software)	ZZ4600060
CANOpen card (kit hardware and software)	ZZ4600070
ControlNet card (kit hardware and software)	ZZ4600080
Ethernet+IT card (kit hardware and software)	ZZ4600100
ES851 Datalogger GSM /modem/ethernet card (kit hardware and software)	ZZ0101820
Encoder cards	
These cards mount in the encoder slot within the drive	
ES 836 Encoder card with internal 5-24 V encoder supply	ZZ0095834
ES 860 SINCOS Encoder card ¹⁾	ZZ0101830
PC software kits	
Kit for use with REMOTE DRIVE software includes cable and USB/RS 485 converter. Download REMOTE DRIVE from www.nhp-online.com.au	SPUSB
Application software	
SW Multipumps control	ZZ4590010
SW Servodiameters and enhanced PID control ¹⁾	ZZ4590020
SW Regenerative operation	ZZ4590040
SW 2000 Hz operation ¹⁾	ZZ4590050
SW Axis control ¹⁾	ZZ4590060
SW Multipositioner application ¹⁾	ZZ4590070
IP 54 customised control kits to suit SP --- 4T BA2K5 models ²⁾	
Potentiometer and start/stop pushbuttons	SP501- XX ³⁾
Potentiometer and forward/off/reverse selector switch	SP502- XX ³⁾
Emergency stop and local/off/remote selector switch	SP500- XX ³⁾
Other combinations available to suit the specific application.	

Notes: ¹⁾ Under development.

²⁾ Kit includes metal cover with buttons and wiring loom.

³⁾ Replace 'xx' with frame size number.

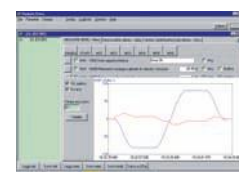

Mounting and Connections

Mounting dimensions

IP 20/IP 00

Size	x (mm)	x1 (mm)	Y (mm)	D1 (mm)		Fastening screw
S05	156	-	321	4.5	-	M4
S10	192	-	377	6	12.5	M5
S15	185	-	449	7	15	M6
S20	175	-	593	7	15	M6
S30	213	-	725	9	20	M8
S40	540	270	857	9	20	M8
S50	560	280	975	11	21	M8-M10
S60	570	285	1238	13	28	M10-M12
S65 ¹⁾	178	-	1350	11	25	M10
S70 ¹⁾	178	-	1350	11	25	M10
S75 ¹⁾	178	-	1350	11	25	M10
S80 ¹⁾	178	-	1350	11	25	M10

¹⁾ Dimensions per module

IP 54

Size	x (mm)	x1 (mm)	Y (mm)	D1 (mm)		Fastening screw
S05	156	-	321	4.5	-	M4
S10	192	-	377	6	12.5	M5
S15	185	-	449	7	15	M6
S20	175	-	593	7	15	M6
S30	213	-	725	9	20	M8

Minimum mounting clearance

Size	A (mm)	B (mm)	C (mm)	D (mm)	E (mm)	F Max (mm)
S05	20	40	50	100	-	-
S10	30	60	60	120	-	-
S15	30	60	80	150	-	-
S20	50	100	100	200	-	-
S30	100	200	200	200	-	-
S40-50	100	200	200	300	-	-
S60	150	300	500	300	-	-
S65-80		300	500	300	20-50	400

E = Distance between inverter modules F = Distance between inverter and rectifier

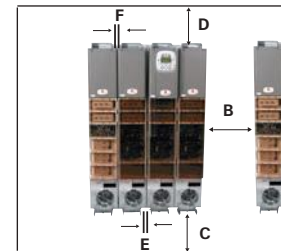
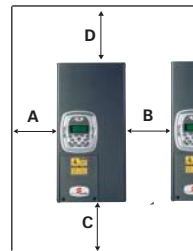
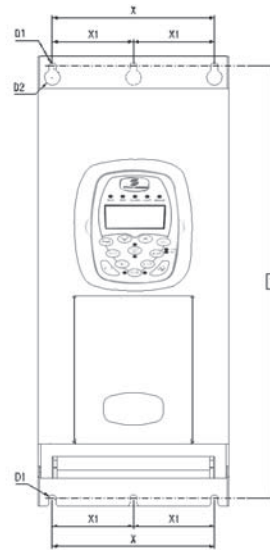

Cables size

380-500 V

Size	Cat. No. SP-4T...	I _{nom} A	Power Terminal Cable Size Accepted mm ²	Cable size Supply/Motor mm ²	Control Terminal Cable Size Accepted mm ²
S05	0005	10.5	0.5-10	2.5	0.08-1.5 (02-2.5 relays MDO3 and MDO4 only)
	0007	12.5			
	0009	16.5			
	0011	16.5			
	0014	16.5			
S10	0016	26	10	25	0.08-1.5 (02-2.5 relays MDO3 and MDO4 only)
	0017	30			
	0020	30			
	0025	41			
	0030	41			
	0035	41			
S15	0038	65	25	25	0.08-1.5 (02-2.5 relays MDO3 and MDO4 only)
	0040	72			
	0049	80			
S20	0060	88	25-50	35	0.08-1.5 (02-2.5 relays MDO3 and MDO4 only)
	0067	103			
	0074	120			
	0086	135			
S30	0113	180	35-185	95	0.08-1.5 (02-2.5 relays MDO3 and MDO4 only)
	0129	195			
	0150	215			
	0162	240			
	0179	300			
S40	0200	345	70-240	185	0.08-1.5 (02-2.5 relays MDO3 and MDO4 only)
	0200	345			
	0216	375			
	0250	390			
	0312	480			
S50	0366	550	Bar	2x150	0.08-1.5 (02-2.5 relays MDO3 and MDO4 only)
	0399	630			
	0399	630			

Size	Model SP-4T...	I _{nom} A	Power Terminal Cable Size Accepted mm ²	Cable size Supply/Motor mm ²	Control Terminal Cable Size Accepted mm ²
S60	0457	720	Bar	2x240	0.08-1.5 (02-2.5 relays MDO3 and MDO4 only)
	0524	800			
S65	0598	900	Bar	3x240	0.08-1.5 (02-2.5 relays MDO3 and MDO4 only)
	0748	1000			
S75	0831	1200	Bar	6x210	0.08-1.5 (02-2.5 relays MDO3 and MDO4 only)
	0964	1480			
	1130	1700			
	1296	1950		6x240	

660-690 V

Size	Cat. No. SP-4T...	I _{nom} A	Power Terminal Cable Size Accepted mm ²	Cable size Supply/Motor mm ²	Control Terminal Cable Size Accepted mm ²
S40	Details coming soon. Contact NHP for further details.				
S50	Details coming soon. Contact NHP for further details.				
S60	Details coming soon. Contact NHP for further details.				
S65	0250	390	Bar	240	0.08-1.5 (0.2-2.5 relays MDO3 and MDO4 only)
	0312	480			
	0366	550			
	0399	630			
	0457	720			
	0524	800			
	0598	900			
S70	0831	1200		3x240	
S75	0964	1480		3x240	
S80	1130	1700		6x240	
	1296	1950			

Circuit protection devices

380- 500V

Size	Cat. No. SP---4T...	I _{nom} A	Semi-conductor Fuse (700V) A	MCB A	AC 1 Contactor A
S05	0005	10.5	16	16	25
	0007	12.5	16	16	25
	0009	16.5	25	25	25
	0011	16.5	25	25	25
	0014	16.5	32	32	30
S10	0016	26	40	40	45
	0017	30	40	40	45
	0020	30	40	40	45
	0025	41	63	63	55
	0030	41	63	63	60
S15	0035	41	100	100	100
	0038	65	100	100	100
	0040	72	100	100	100
S20	0049	80	100	100	100
	0060	88	125	125	115
	0067	103	125	125	125
S30	0074	120	160	160	145
	0086	135	200	160	160
	0113	180	250	200	250
	0129	195	250	250	250
	0150	215	315	400	275
S40	0162	240	400	400	275
	0179	300	400	400	350
	0200	345	400	400	400
	0216	375	500	630	450
	0250	390	630	630	450
S50	0312	480	800	630	550
	0366	550	800	800	600
	0399	630	800	800	700

Size	Cat. No. SP---4T...	I _{nom} A	Semi-conductor Fuse (700V) A	MCB A	AC 1 Contactor A
S60	0457	720	1000	800	800
	0524	800	1000	1000	1000
S65	0598	900	1250	1250	1000
	0748	1000	1250	1250	1200
	0831	1200	1600	1600	1600
S75	0964	1480	2 x 1000	2000	2X1000
	1130	1700	2 x 1250	2000	2X1200
	1296	1950	2 x 1250	2500	2X1200

660-690V

Cat. No.	Cat. No. SP---6T...	I _{nom} A	Semi-conductor Fuse (700V) A	MCB A	AC 1 Contactor A
S40 S50 S60	Details coming soon. Contact NHP for further details.				
S65	0250	390	630	630	450
	0312	480	800	800	550
	0366	550	800	800	600
	0399	630	800	800	700
	0457	720	1000	1000	800
	0524	800	1000	1000	1000
	0598	900	1250	1250	1000
	0748	1000	1250	1250	1200
S70	0831	1200	2 x 800	1600	2 x 800
S75	0964	1480	2 x 1000	2000	2 x 1000
S80	1130	1700	3 x 800	2000	3 x 800
	1296	1950	3 x 800	2500	3 x 800

Wiring diagram

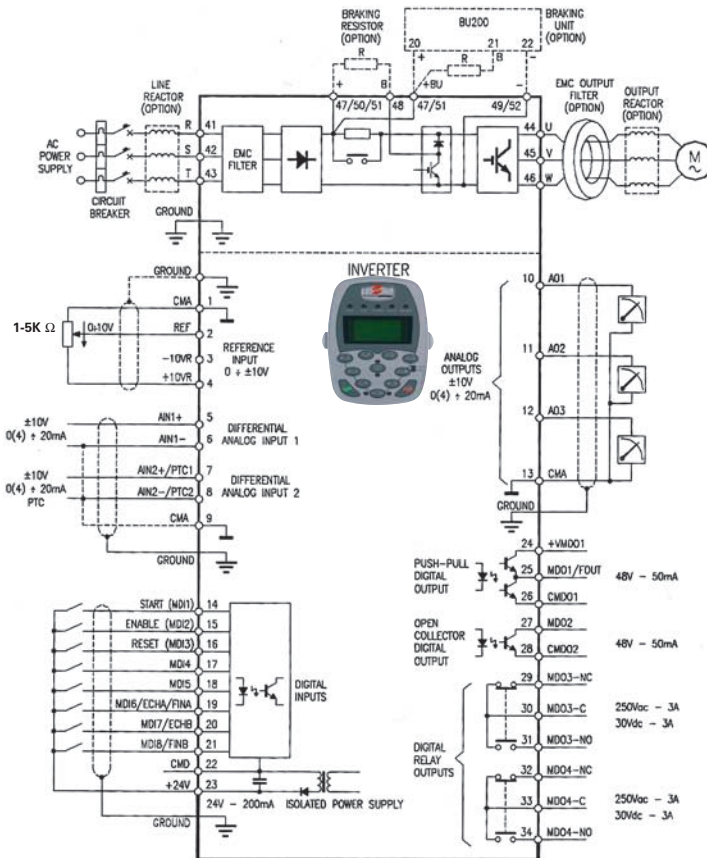

Keypad

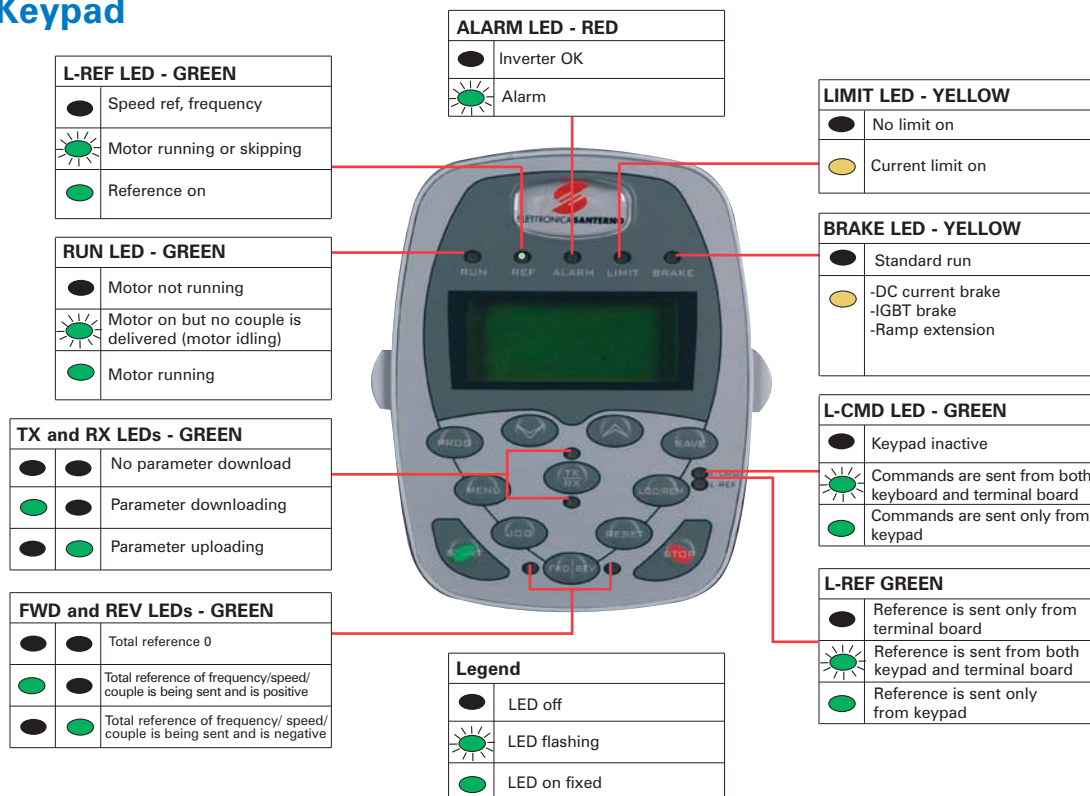

Key

Function

	In programming mode, is used to enter parameter groups and individual parameters. Used to accept changes and write them to non-volatile memory.
	In programming mode, is used to step back one level or accept parameter settings without writing to non-volatile memory.
	Up arrow; scrolls through menus and sub-menus. Also allows parameter settings to be selected. When pressed together with the down arrow moves to the next menu.
	Down arrow; scrolls through menus and sub-menus. Also allows parameter changes to be selected. When pressed together with the up arrow moves to the next menu.
	Scrolls between the start page, keypad page and returns to the original page.
	Allows the upload and download of parameter settings to and from the keypad.
	When pressed, forces control from the keypad of commands and reference. If pressed again, returns control to the previous configuration.
	If enabled (requires one of the command sources to be selected from the keypad) toggles between the forward and reverse operation.
	If enabled (requires one of the command sources to be selected from the keypad) sets the reference speed to the preset Jog speed.
	Allows alarm trips to be reset once the cause of the alarm has been removed.
	If enabled (requires one of the command sources to be selected from the keypad), starts the motor.
	If enabled (requires one of the command sources to be selected from the keypad), stops the motor.

Applications

The SINUS PENTA range offers the flexibility to adapt to a wide range of applications. Some of these applications include;

Heating Ventilation and Air Conditioning (HVAC)

The standard IP 54 SINUS PENTA solution is perfectly suited to HVAC applications. The drive incorporates advanced PID functions for automatic control and extensive communications to allow control and monitoring from a Building Management System. With the inclusion of a Fire Mode function for extended operation during critical periods, the drive provides the features, robustness and reliability required. The drive also includes the ability to start on a rotating load to ensure trip free operation.

Pumping

With integrated PID and the option for multipump software the SINUS PENTA is ideal for use in pumping applications. The high IP rating can be used for standalone applications or the IP 20 and IP 00 can be used in cases where the drive must be incorporated into an enclosed system. The extensive PID function also includes control of wake and sleep levels to ensure sufficient operation.

Conveyors

Whether the conveyor system requires fixed or variable speed control, synchronising with parallel conveyors or positioning to allow precise control of stopping locations, the SINUS PENTA has the in-built capabilities and performance required. The drive is capable of starting unloaded or fully loaded and can incorporate a built-in jog button for operation when in local control.

Hoisting

Demanding applications such as hoisting applications are easily achieved using the high overload capability of the SINUS PENTA. Together with integrated functions to handle brake control and fluxing to ensure optimum motor magnetisation the load is always controlled without the need for encoder feedback. Regeneration caused by lowering loads can either be handled through brake resistors or by using a fully regenerative drive.

Winders

Tension control and linear speed control are typical requirements for winder applications. By utilising torque control in the internal VTC function in either open or closed loop, accurate control of tension can be achieved. For applications requiring a higher level of accuracy, special software is available to incorporate reel diameter calculations and control through dancers and load cells.

Extruders

The high speed accuracy and torque requirement typically required by extruder systems can be achieved through the use of the internal vector control function and a standard AC motor. By incorporating encoder feedback, a high degree of speed accuracy is obtained and thus ensures optimum quality of the item being produced.



SINUS PENTA Specifications

Power range:	2.2-1170 kW / 5 - 1950 A (4T) 280 -2010 kW / 278 - 1950 A (6T)
Input voltage:	AC Supply 4T - 380-500 V AC, 3 phase, - 15 % + 10 % 6T - 525-690 V AC, 3 phase, - 15 % + 10 % DC Supply 4T - 530-705 V DC, -15 % + 10 % 4T - 810-970 V DC, -15 % + 10 %
Input frequency:	50-60 Hz, +/- 10 %
Output voltage:	0-Vin±2 %
Control system:	IFD - V/f control VTC - Sensorless vector control VTC - Closed loop vector control FOC - Field orientated closed loop control SYN - Control for permanent magnet motors RGN - Regenerative front end (option)
Overload current rating:	In accordance with overload selected for 120 secs every 20 mins up to frame S30 and 60 secs every 10 mins for all other sizes.
Starting torque:	Max 240 % for a short time and up to 200 % for 120 secs (dependent on overload selected)
Frequency/Speed resolution:	0.1 Hz IFD, 1 rpm VTC, 0.01 rpm FOC
Speed accuracy:	Open loop ± 2 % of max speed Closed loop < 0.5 % of max speed
Carrier frequency:	0.8 -16 kHz with silent mode, dependent on size and control type
Braking:	30 % DC braking 20 % dynamic braking without brake resistor Up to 150 % with int. brake module and ext. resistor (up to frame S30) or external brake unit and resistor for all other sizes.
Protection functions:	Overcurrent, overvoltage, undervoltage, overload, inverter thermal protection, motor thermal protection, mains failure, communications error, auxiliary fault, encoder error.
Frequency setting:	Digital keypad, external potentiometer, 0 to 10 V, 4 to 20 mA, preset speeds, up/down control, serial interface.
Control setting:	Digital keypad, digital inputs, serial interface
Analog inputs:	3 inputs, selectable between 0-10 V and 0 (4) - 20 mA (12 bit resolution) Input AIN2 can also be used for PTC thermistor monitoring
Digital inputs:	8 inputs - 3 fixed, 5 programmable (multiple assignment possible)
Analog outputs:	3 outputs, selectable between 0-10 V, -10-+10 V and 0 (4)-20 mA
Digital outputs:	1 push-pull transistor output (20-48 V DC, 50 mA max) 1 open collector transistor output (5-48 V DC, 50 mA max) 2 relay outputs with changeover contacts (250 V AC, 30 V DC, 3A)
Keypad:	4 line alphanumeric display 11 status LEDs Dedicated keys for Start, Stop, Fwd/Rev, Jog, Reset, Loc/Rem, Tx/Rx
Enclosure protection:	IP 20 from size S05 to size S40 IP 00 from size S50 to size S80 IP 54 from size S05 to Size S30
Environmental:	0 to +40 °C operation or to +50 °C with derating 5 to 95 % RH non-condensing
Communication:	Standard Modbus / RS 485 Optional Profibus, DeviceNet, Interbus, CANOpen, Control Net, Ethernet and Lonworks
EMC:	AS 61800-3, category C3, second environment or Category C2, first environment with optional ferrite.
Safety:	IEC 61800-5-2 (draft), safe torque off

Approvals:



Notes

www.nicsanat.com

021-87700210



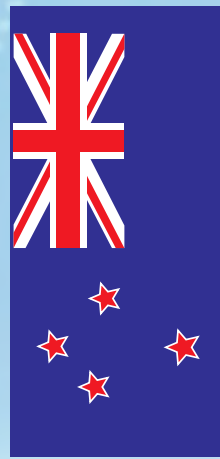
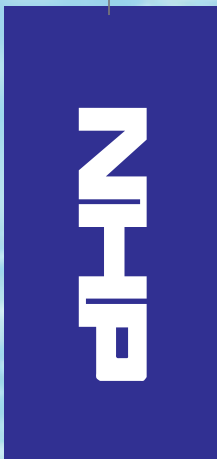
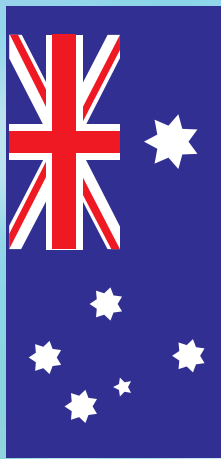

AUSTRALIA www.nhp.com.au

VICTORIA
MELBOURNE HEADQUARTERS
43-67 River Street
Richmond Victoria 3121
Telephone +61 3 9429 2999
Fax +61 3 9429 1075
Email mel-sales@nhp.com.au

*NATIONAL DISTRIBUTION AND
MANUFACTURING CENTRE*
104-106 William Angliss Drive
Laverton North Victoria 3026
Telephone +61 3 9429 2999
Fax +61 3 9368 2997
Email mel-sales@nhp.com.au

TASMANIA
HOBART
2/65 Albert Road
Moonah Tasmania 7009
Telephone +61 3 6228 9575
Fax +61 3 6228 9757
Email tas-sales@nhp.com.au

QUEENSLAND
BRISBANE
16 Riverview Place
Murarrie Queensland 4172
Telephone +61 7 3909 4999
Fax +61 7 3399 9712
Email bris-branch@nhp.com.au

TOWNSVILLE
62 Leyland Street
Garbutt Queensland 4814
Telephone +61 7 4779 0700
Fax +61 7 4775 1457
Email tsv-branch@nhp.com.au

ROCKHAMPTON
14 Robison Street
Rockhampton Queensland 4701
Telephone +61 7 4927 2277
Fax +61 7 4922 2947
Email rkh-branch@nhp.com.au

TOOWOOMBA
Cnr Carroll St & Struan Crt
Toowoomba Queensland 4350
Telephone +61 7 4634 4799
Fax +61 7 4633 1796
Email too-branch@nhp.com.au

CAIRNS
2/1 Bramp Close
Portsmith Queensland 4870
Telephone +61 7 4035 6888
Fax +61 7 4035 6999
Email cns-branch@nhp.com.au

NEW SOUTH WALES
SYDNEY
30-34 Day Street North
Silverwater New South Wales 2128
Telephone +61 2 9748 3444
Fax +61 2 9648 4353
Email syd-branch@nhp.com.au

NEWCASTLE
575 Maitland Road
Mayfield West New South Wales 2304
Telephone +61 2 4960 2220
Fax +61 2 4960 2203
Email ncl-branch@nhp.com.au

SOUTH AUSTRALIA
ADELAIDE
36-38 Croydon Road
Keswick South Australia 5035
Telephone +61 8 8297 9055
Fax +61 8 8371 0962
Email adl-branch@nhp.com.au

WESTERN AUSTRALIA
PERTH
38 Belmont Ave
Rivervale Western Australia 6103
Telephone +61 8 9277 1777
Fax +61 8 9277 1700
Email per-branch@nhp.com.au

NORTHERN TERRITORY
DARWIN
3 Steele Street
Winnellie Northern Territory 0820
Telephone +61 8 8947 2666
Fax +61 8 8947 2049
Email dar-branch@nhp.com.au

NEW ZEALAND www.nhp-nz.com

AUCKLAND
7 Lockhart Place
Mt Wellington Auckland
Telephone +64 9 276 1967
Fax +64 9 276 1992
Email sales@nhp-nz.com

CHRISTCHURCH
85 Gasson Street
Sydenham Christchurch
Telephone +64 3 377 4407
Fax +64 3 377 4405
Email sales@nhp-nz.com



ELECTRICAL ENGINEERING PRODUCTS PTY LTD

A.B.N 84 004 304 812