

SIEMENS

SINUMERIK

SINUMERIK 802D sl Operating Instructions

Operating Instructions



www.nicsanat.com

021-87700210

Valid for Software version SINUMERIK 802D sl G/N 1.1
SINUMERIK 802D sl T/M 1.2

12/2006
6FC5397-0CP10-2BA0

Foreword	
Description	1
interfaces	2
Application planning	3
Assembling	4
Connecting	5
Operation (hardware)	6
Commissioning (General)	7
Initial start-up	8
Commissioning the drives using HMI	9
Edit a drive project with STARTER	10
Starting Up the PLC	11
Data Backup and Series Machine Start-Up	12
Technical data	13
Dimensional Drawings	14
ESD guidelines	A
List of abbreviations	B

Safety Guidelines

This manual contains notices you have to observe in order to ensure your personal safety, as well as to prevent damage to property. The notices referring to your personal safety are highlighted in the manual by a safety alert symbol, notices referring only to property damage have no safety alert symbol. These notices shown below are graded according to the degree of danger.



Danger

indicates that death or severe personal injury **will** result if proper precautions are not taken.



Warning

indicates that death or severe personal injury **may** result if proper precautions are not taken.



Caution

with a safety alert symbol, indicates that minor personal injury can result if proper precautions are not taken.

Caution

without a safety alert symbol, indicates that property damage can result if proper precautions are not taken.

Notice

indicates that an unintended result or situation can occur if the corresponding information is not taken into account.

If more than one degree of danger is present, the warning notice representing the highest degree of danger will be used. A notice warning of injury to persons with a safety alert symbol may also include a warning relating to property damage.

Qualified Personnel

The device/system may only be set up and used in conjunction with this documentation. Commissioning and operation of a device/system may only be performed by **qualified personnel**. Within the context of the safety notes in this documentation qualified persons are defined as persons who are authorized to commission, ground and label devices, systems and circuits in accordance with established safety practices and standards.

Prescribed Usage

Note the following:



Warning

This device may only be used for the applications described in the catalog or the technical description and only in connection with devices or components from other manufacturers which have been approved or recommended by Siemens. Correct, reliable operation of the product requires proper transport, storage, positioning and assembly as well as careful operation and maintenance.

Trademarks

All names identified by ® are registered trademarks of the Siemens AG. The remaining trademarks in this publication may be trademarks whose use by third parties for their own purposes could violate the rights of the owner.

Disclaimer of Liability

We have reviewed the contents of this publication to ensure consistency with the hardware and software described. Since variance cannot be precluded entirely, we cannot guarantee full consistency. However, the information in this publication is reviewed regularly and any necessary corrections are included in subsequent editions.

Foreword

SINUMERIK documentation

The SINUMERIK documentation is organized in 3 parts:

- General Documentation
- User Documentation
- Manufacturer/service documentation

A list of documents, updated on a monthly basis, is available on the Internet for the available languages at:

<http://www.siemens.com/motioncontrol>

Select "Support"/"Technical Documentation"/"Overview of Documents".

The Internet version of the DOConCD (DOConWEB) is available at:

<http://www.automation.siemens.com/doconweb>

You can find information on the training courses offered and FAQs (frequently asked questions) on the Internet under:

<http://www.siemens.com/motioncontrol> (under "Support")

Target group

This manual is intended for use by planners, configuration engineers, technicians, installation personnel, programmers, commissioning personnel, operators, service and maintenance personnel

Benefits

The operating instructions impart knowledge about the components and allow the addressed target groups to properly and safely install, set up, test and commission the SINUMERIK 802D sl.

Standard scope

This documentation only describes the functionality of the standard version. Additions or revisions made by the machine tool manufacturer are documented by the machine tool manufacturer.

Other functions not described in this documentation might be executable in the control. However, no claim can be made regarding the availability of these functions when the equipment is first supplied or in the event of servicing.

For the sake of simplicity, this documentation does not contain all detailed information about all types of the product and cannot cover every conceivable case of installation, operation, or maintenance.

Technical support

In case of questions, please contact us through the following hotline:

Table 1 Europe and Africa time zone

A&D Technical Support

Phone: +49 (0) 180 / 5050 - 222

Fax: +49 (0) 180 / 5050 - 223

Internet: <http://www.siemens.com/automation/support-request>

E-mail: <mailto:adsupport@siemens.com>

Table 2 Asia and Australia time zone

A&D Technical Support

Phone: +86 1064 719 990

Fax: +86 1064 747 474

Internet: <http://www.siemens.com/automation/support-request>

E-mail: <mailto:adsupport@siemens.com>

Table 3 American time zone

A&D Technical Support

Phone: +1 423 262 2522

Fax: +1 423 262 2289

Internet: <http://www.siemens.com/automation/support-request>

E-mail: <mailto:adsupport@siemens.com>

Questions about the Manual

If you have any queries (suggestions, corrections) in relation to this documentation, please fax or e-mail us:

Fax: +49 (0) 9131 / 98 63315

E-mail: <mailto:adsupport@siemens.com>

Fax form: See the reply form at the end of this publication

SINUMERIK Internet address

<http://www.siemens.com/sinumerik>

EC declaration of conformity

The EC Declaration of Conformity for the EMC Directive can be found/obtained

- on the Internet:
<http://www.ad.siemens.de/csinfo>
under product/Order No. 15257461
- at the relevant regional office of the A&D MC Group of Siemens AG.

Further notes

Note

This symbol always appears in the document where further information is provided.

Licensing provisions

The software SINUMERIK 802D sl is protected by national and international copyright laws and agreements. Unauthorized reproduction and distribution of this software or parts thereof is liable to prosecution. It will be prosecuted both according to criminal and civil law and may result in severe punishment or demands for compensation.

In the software SINUMERIK 802D sl, open source software is used. The licensing provisions for this software are located on the Toolbox CD and are to be observed accordingly.

Acceptance report

You can find a sample report for the acceptance of SINUMERIK 802D sl on the Internet at:
<http://support.automation.siemens.com> under the heading Current > Acceptance reports

Table of contents

	Foreword	3
1	Description.....	13
1.1	System overview	13
1.2	Description of components	17
2	interfaces.....	21
2.1	CNC operator panel interfaces	21
2.1.1	Compact flash card (CF card) slot	21
2.1.2	Ethernet interface.....	21
2.1.3	USB port (available soon).....	22
2.1.4	RS232 COM port	22
2.1.5	PROFIBUS DP interface.....	23
2.1.6	DRIVE-CLiQ interface.....	24
2.1.7	Handwheel connection.....	24
2.1.8	Digital inputs/outputs.....	25
2.2	MCPA module interfaces	28
2.3	Interfaces of the machine control panel MCP 802D sl	31
2.4	PP 72/48 I/O module interfaces	34
2.5	Interfaces of the machine control panel MCP.....	40
2.6	Interfaces of the DP/DP coupler	42
3	Application planning.....	43
3.1	Overview	43
3.2	General rules for operation of a SINUMERIK 802D sl.....	44
3.3	Rules regarding current consumption and power loss of a cubicle arrangement.....	45
4	Assembling	47
5	Connecting	49
5.1	Overall design of the SINUMERIK 802D sl.....	49
5.2	Connecting the protective conductor for the individual components	50
5.3	Connection overview for SINUMERIK 802D sl.....	51
5.4	Connecting the MCPA module.....	52
5.5	Connecting an analog spindle.....	53
5.6	Connecting the high-speed digital inputs/outputs at the MCPA module	55
5.7	Connecting the power supply.....	55
5.8	Connecting the NC full keyboard to the CNC operator panel.....	57
5.9	Connecting the Ethernet interface	57

5.10	Connecting the RS232 COM port	57
5.11	Connecting the PP72/48 I/O module	58
5.12	Connecting the DP/DP coupler	61
5.13	Connecting the SINAMICS drive to the DRIVE-CLiQ interface	63
5.14	Connecting the digital inputs/outputs to the PCU	64
5.15	Connecting the digital inputs/digital outputs to the PP72/48 I/O module	64
5.16	Connecting the machine control panel to the PP72/48 I/O module	65
5.17	Connecting shielded cables via the shield connection (PCU)	65
6	Operation (hardware).....	67
6.1	Operator control and display elements	67
6.2	Status and error displays	67
7	Commissioning (General)	69
7.1	Initial commissioning (IBN).....	69
7.2	Access levels	70
7.3	RCS tool.....	71
7.4	STARTER commissioning tool.....	72
7.4.1	The STARTER user interface	72
7.4.2	Operating philosophy of the STARTER commissioning tool for SINAMICS S120	73
7.4.3	Diagnosis via STARTER	74
7.4.3.1	Function generator	75
7.4.3.2	Trace function	78
8	Initial start-up	81
8.1	Turning on and booting the control system.....	81
8.2	Language setting and file management.....	82
8.2.1	Creating and Editing Projects	82
8.2.2	Help, language and alarm files	84
8.3	Setting the technology.....	86
8.4	Input of the machine data.....	88
8.5	Activating the high-speed digital inputs/digital outputs	89
8.6	Setting the Profibus addresses	90
8.7	Starting Up the PLC	93
8.8	Commissioning of drives (SINAMICS)	93
8.9	Set the axis/spindle-specific machine data	93
8.9.1	Default settings of the axis machine data for feed axes	95
8.9.2	Default settings of the axis machine data for the spindle	96
8.9.3	PLC-controlled axis	101
8.9.4	Completion of the commissioning of the axes/spindle	105
8.10	Completing the commissioning	105

9	Commissioning the drives using HMI	107
9.1	Terminal assignment X20 / X21.....	113
10	Edit a drive project with STARTER	117
10.1	Change a drive project OFFLINE.....	117
10.1.1	Example: Commissioning a direct measuring system for a spindle.....	122
10.1.2	Interface settings on PG/PC.....	134
10.2	Operating the STARTER control panel (motor rotating).....	136
10.2.1	Loading the project into the drive unit.....	136
10.2.2	Operating the control panel.....	139
11	Starting Up the PLC	147
11.1	Overview.....	147
11.2	Programming Tool PLC802.....	148
11.2.1	Selecting the target system.....	148
11.2.2	Interface to PLC.....	149
11.3	First commissioning of the PLC.....	154
11.4	Commissioning modes of the PLC.....	154
11.5	PLC alarms.....	156
11.5.1	Overview.....	156
11.5.2	General PLC alarms.....	157
11.5.3	User alarms.....	157
11.6	PLC Programming.....	159
11.6.1	Overview.....	159
11.6.2	Overview of commands.....	161
11.6.3	Explanation of the stack operations.....	163
11.6.4	Program organization.....	171
11.6.5	Data management.....	172
11.6.6	Testing and monitoring your program.....	172
11.7	PLC application Download/Upload/Copy/Compare.....	172
11.8	User interface.....	175
12	Data Backup and Series Machine Start-Up	177
12.1	Data Backup.....	177
12.1.1	Internal data backup.....	177
12.1.2	External data backup.....	178
12.1.3	Data backup via the RS232/Ethernet interface.....	179
12.1.4	External data backup via CF Card.....	180
12.1.5	Data backup in case of backlight failure.....	180
12.2	Series commissioning.....	181
13	Technical data	185
13.1	Electro-Magnetic Compatibility.....	187
13.2	Transport and storage conditions.....	188
13.3	Ambient operating conditions for the operation.....	188
13.4	Specifications for Protection Class and Degree of Protection.....	190

14	Dimensional Drawings	191
14.1	CNC operator panel (PCU) dimension drawing and hole drilling template.....	191
14.2	Dimensions and hole drilling template of the machine control panel (MCP)	195
14.3	NC full keyboard dimension and hole drilling templates	197
14.4	PP72/48 peripheral module dimension drawing	199
14.5	Dimensional drawing MCPA module	200
A	ESD guidelines	201
A.1	What does ESD mean?.....	201
A.2	Electrostatic Discharge to Persons	201
A.3	Basic protective measures against discharge of static electricity	202
B	List of abbreviations	203
B.1	Abbreviations 802D sl	203
	Index	205

Tables

Table 1	Europe and Africa time zone.....	4
Table 2	Asia and Australia time zone.....	4
Table 3	American time zone	4
Table 1-1	PCU interfaces	19
Table 2-1	Pin assignment of female connector X5	21
Table 2-2	Pin assignment of connector X8	22
Table 2-3	Pin assignment of female connector X6	23
Table 2-4	Pin assignment of female connector X1 and X2	24
Table 2-5	Pin assignment of connector X30	25
Table 2-6	Pin assignment of the connectors X20 and X21	27
Table 2-7	Interfaces and status display	29
Table 2-8	Pin assignment of connectors X1 and X2	29
Table 2-9	Pin assignment of the connectors X1020 and X1021	30
Table 2-10	Pin assignment of connector X701	31
Table 2-11	Interfaces.....	32
Table 2-12	Pin assignment of the connectors X1201 and X1202.....	33
Table 2-13	Interfaces.....	35
Table 2-14	Female connector X2 pin assignment.....	36
Table 2-15	Pin assignment of the connectors X111, X222, X333	36
Table 2-16	Interfaces.....	40
Table 2-17	Pin assignment of the connectors X1201 and X1202.....	41

Table 5-1	Assignment of the X520 interface	54
Table 5-2	Electrical parameters of the load power supply for the CNC operator panel (X40) and for the PP72/48 I/O module (X1).....	55
Table 5-3	Pin assignment of the screw-terminal blocks X40 (on the PCU) and X1 (on the I/O module)	56
Table 6-1	Status and error displays	68
Table 6-2	Status displays	68
Table 7-1	Access level concept	70
Table 8-1	Example of machine data setting.....	90
Table 8-2	Setting the Profibus address.....	90
Table 8-3	Setting the Profibus address on the PP 72/48.....	91
Table 8-4	Assignment of the input/output bytes.....	91
Table 8-5	Setting the Profibus address on the DP/DP coupler.....	92
Table 8-6	Assignment of the input/output bytes.....	92
Table 8-7	Setpoint/actual value assignment	93
Table 8-8	maximum configuration.....	94
Table 8-9	Adapting the axis machine data for the milling machine	94
Table 8-10	Adapting the axis machine data for the nibbling machine	95
Table 8-11	Adapting the axis machine data.....	95
Table 8-12	Default settings of the axis machine data for feed axes	96
Table 8-13	Default settings of the axis machine data for the spindle	97
Table 8-14	Additional machine data.....	98
Table 8-15	Machine data to be set.....	98
Table 8-16	Machine data settings for analog spindle	99
Table 8-17	Machine data for the example.....	100
Table 8-18	Additional machine data.....	100
Table 8-19	Additional machine data.....	101
Table 8-20	Adapting the axis machine data.....	101
Table 8-21	PLC axis control signals.....	102
Table 8-22	Error messages via NCK	103
Table 9-1	Configuring the X20 clamp after SINAMICS commissioning using HMI.....	113
Table 9-2	Configuring the X21 clamp after SINAMICS commissioning using HMI.....	114
Table 10-1	Control word sequential control	142
Table 11-1	Commissioning modes.....	154
Table 11-2	PLC data types permitted in the control system	160
Table 11-3	Operand identifier	161
Table 11-4	Structure of V-range addresses (see user interface).....	161

Table 11-5	802D sl address ranges	161
Table 11-6	Special Marker SM Bit Definition	162
Table 11-7	BASIC BOOLEAN INSTRUCTIONS	163
Table 11-8	OTHER BOOLEAN INSTRUCTIONS	163
Table 11-9	BYTE COMPARES	163
Table 11-10	WORD COMPARES	164
Table 11-11	DOUBLE WORD COMPARES	165
Table 11-12	REAL WORD COMPARES.....	165
Table 11-13	TIMER	166
Table 11-14	COUNTER.....	166
Table 11-15	MATH OPERATIONS	167
Table 11-16	INCREMENT, DECREMENT	168
Table 11-17	LOGIC OPERATIONS	168
Table 11-18	SHIFT AND ROTATE OPERATIONS.....	169
Table 11-19	CONVERSION OPERATIONS	169
Table 11-20	PROGRAM CONTROL FUNCTIONS.....	170
Table 11-21	MOVE, FILL AND FIND OPERATIONS.....	171
Table 13-1	Connected loads	185
Table 13-2	Dimensions and weight.....	185
Table 13-3	Digital inputs of the PP72/48 I/O module.....	186
Table 13-4	Digital outputs of the PP72/48 I/O module.....	186
Table 13-5	Interference emission of electromagnetic fields as per EN 55011: Limit value class A, group 1.	187
Table 13-6	Interference emission via network alternating current supply in accordance with EN 55011: Limit value class A, group 1.	187
Table 13-7	Shipping and storage conditions.....	188
Table 13-8	Climatic environmental conditions	189
Table 13-9	Mechanical ambient conditions.....	189

Description

1.1 System overview

Overview

The CNC operator panel of the **SINUMERIK 802D sl** control systems combines all CNC, PLC, HMI and communication tasks in one component. The maintenance-free hardware integrates the DRIVE-CLiQ interface for the drives and PROFIBUS interface for the I/O modules with the slimline operator panel into a ready-to-install unit (Panel Control Unit).

The **SINUMERIK 802D sl** can control up to 6 axes digitally. At the most, up to 5 NC axes of these 6 axes and one PLC axis can be configured. Up to 2 of these 5 NC axes can be configured as a spindle.

1.1 System overview

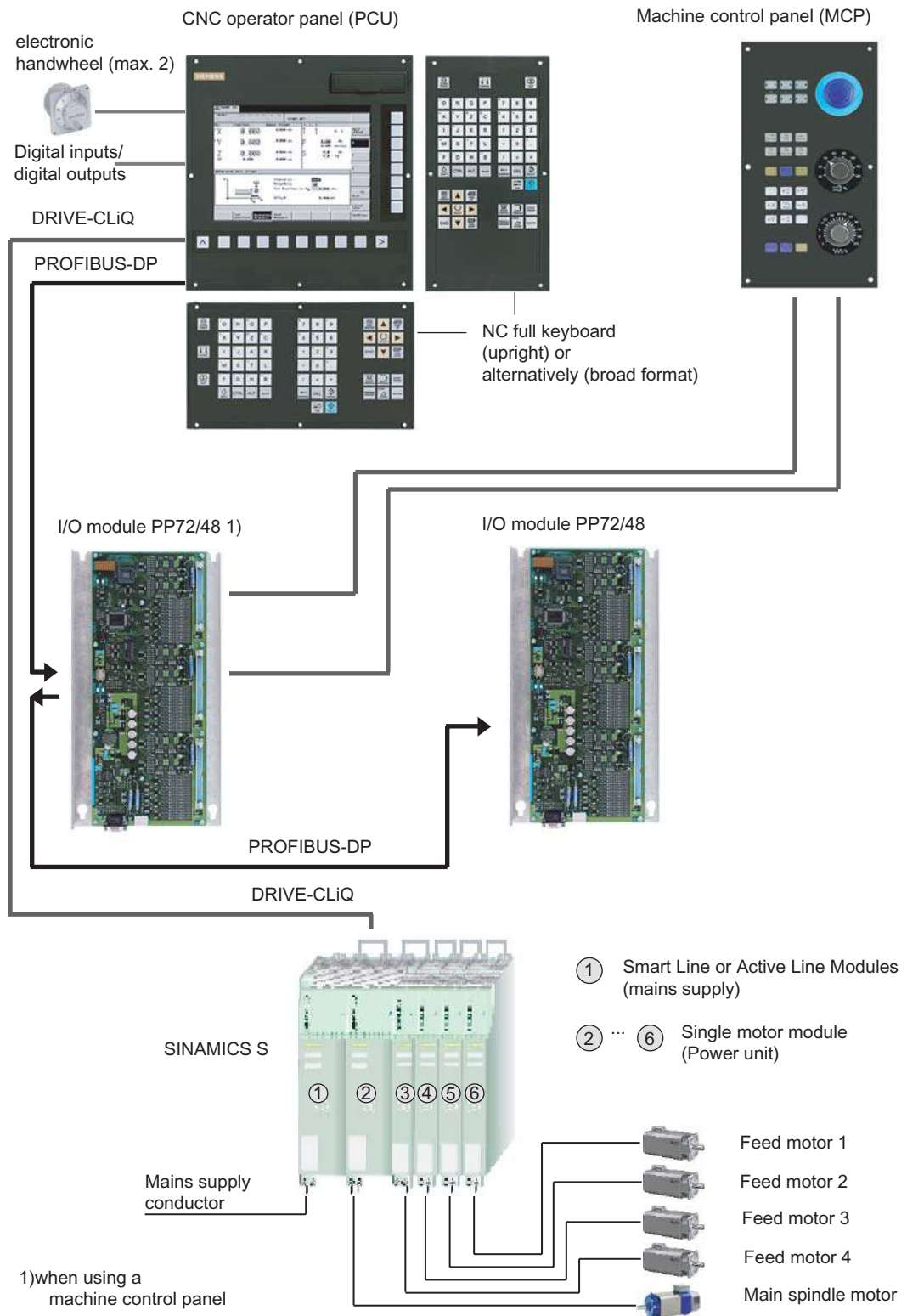

Figure 1-1 SINUMERIK 802D sl with SINAMICS S120 (example configuration)

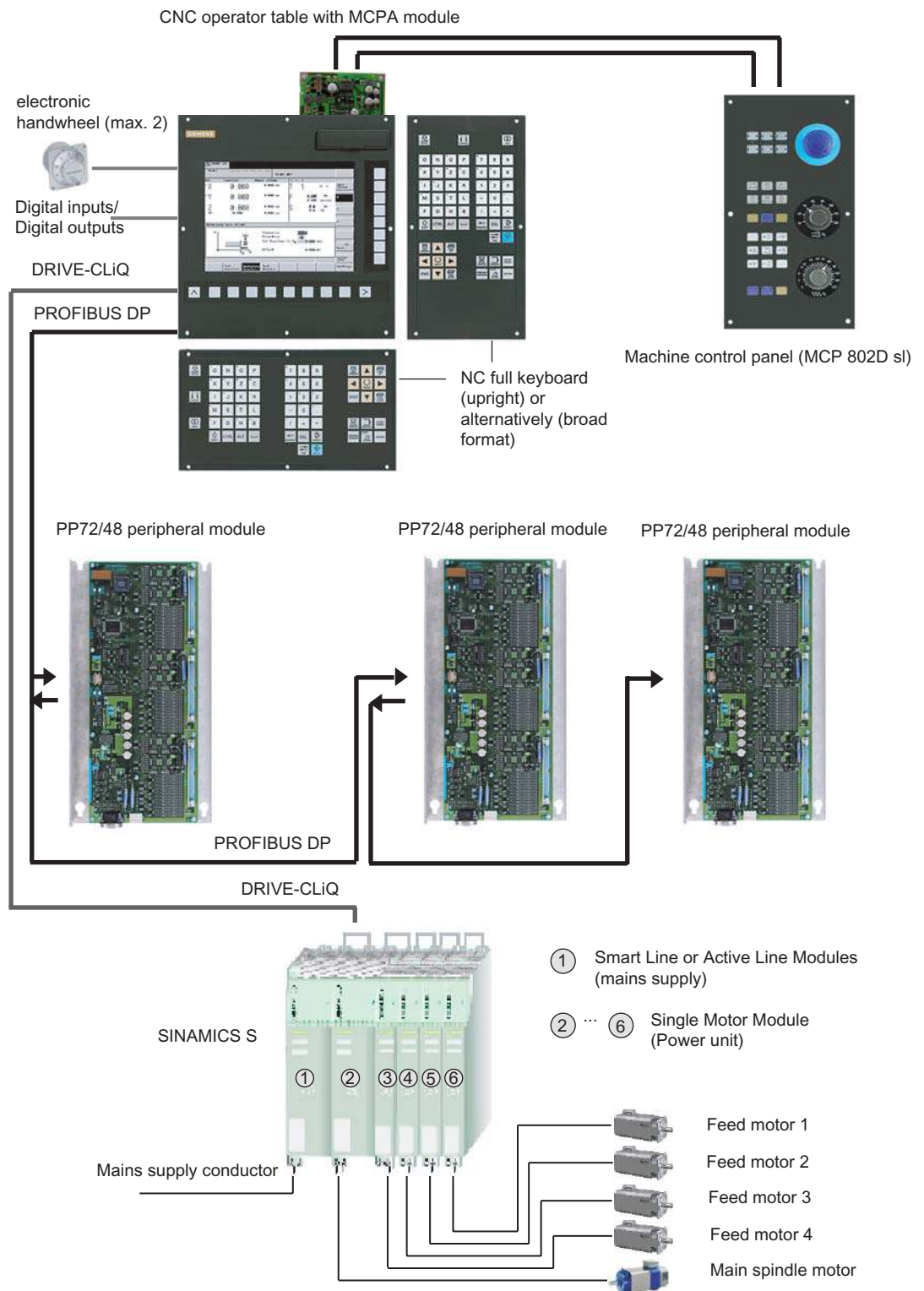

Figure 1-2 SINUMERIK 802D sl with MCPA module (example configuration)

Components

The components of the SINUMERIK 802D sl control system are:

- **CNC operator panel (PCU) with CNC full keyboard** (portrait or landscape format)
- **Machine control panel**

Incorporates all keys and switches required for the operation of a machine The machine control panel is available in 2 versions:

- Machine control panel MCP to connect via a PP 72/48 I/O module
- Machine control panel MCP 802D sl to connect via an MCPA module

- **MCPA module (hardware optional)**

The MCPA module is a supplemental/expansion module of the SINUMERIK 802D sl. It places the following resources at your disposal:

- Analog output for ± 10 V (X701) for connecting an analog spindle
- Interface for connecting an external machine control panel (X1, X2)
- Interface for connecting inputs and outputs (1 bytes each) in the form of high-speed inputs/outputs.

- **PP72/48 I/O module**

The PP72/48 I/O module is a user-friendly and low-cost module (without a separate housing) within the framework of an automation system based on PROFIBUS DP for connecting digital inputs/outputs.

The module has the following important features:

- PROFIBUS DP connection (12 Mbits/s max.)
- 72 digital inputs and 48 digital outputs
- On-board status display via four diagnostic LEDs

To supply the module and the digital outputs, an external voltage source (+24VDC) is required.

- **Drive units**

- **SINAMICS S120**

The communication between the SINUMERIK 802D sl control system and the SINAMICS S120 drive is provided via the DRIVECLiQ communication system (Drive Component Link with IQ).

System software

The following system software is installed in the retentive internal memory of the PCU of each SINUMERIK 802D sl by default:

- **Boot software** - starts the system
- **Human Machine Interface (HMI) software** - realizes all operator functions
- **NCK software (NC Kernel)** - realizes all NC functions.
- **Programmable Logic Control (PLC) software** - executes the integrated PLC user program cyclically.

Toolbox

A tool box is delivered on CD ROM together with the appropriate system software.

The toolbox contains software tools for configuring the control system. It must be installed on your PC/PG.

The following software can be found in the Toolbox:

- Configuration data for the SINUMERIK 802D sl:
 - Setup file for the technologies
 - Cycle packages for the technologies
 - Reloadable languages
- SIMATIC Automation License Manager
The Automation License Manager is needed for managing license keys (e.g. for RCS802).
- RCS802 Commissioning and diagnostic tool (must be licensed for Ethernet and remote control function)
This program can be used to transfer texts, user data and programs from the PC to the CNC operator panel (PCU) and vice versa.
- PLC 802 programming tool
Tool to create PLC user program
- PLC user library
PLC sample programs
- STARTER
Parameterization and commissioning tool for the "SINAMICS" drive

Note

The table of contents and notes for setup can be found in the siemens.txt file.

1.2 Description of components

View

The illustration below shows the CNC operator panel (PCU) with its interfaces and the front panel elements.

1.2 Description of components

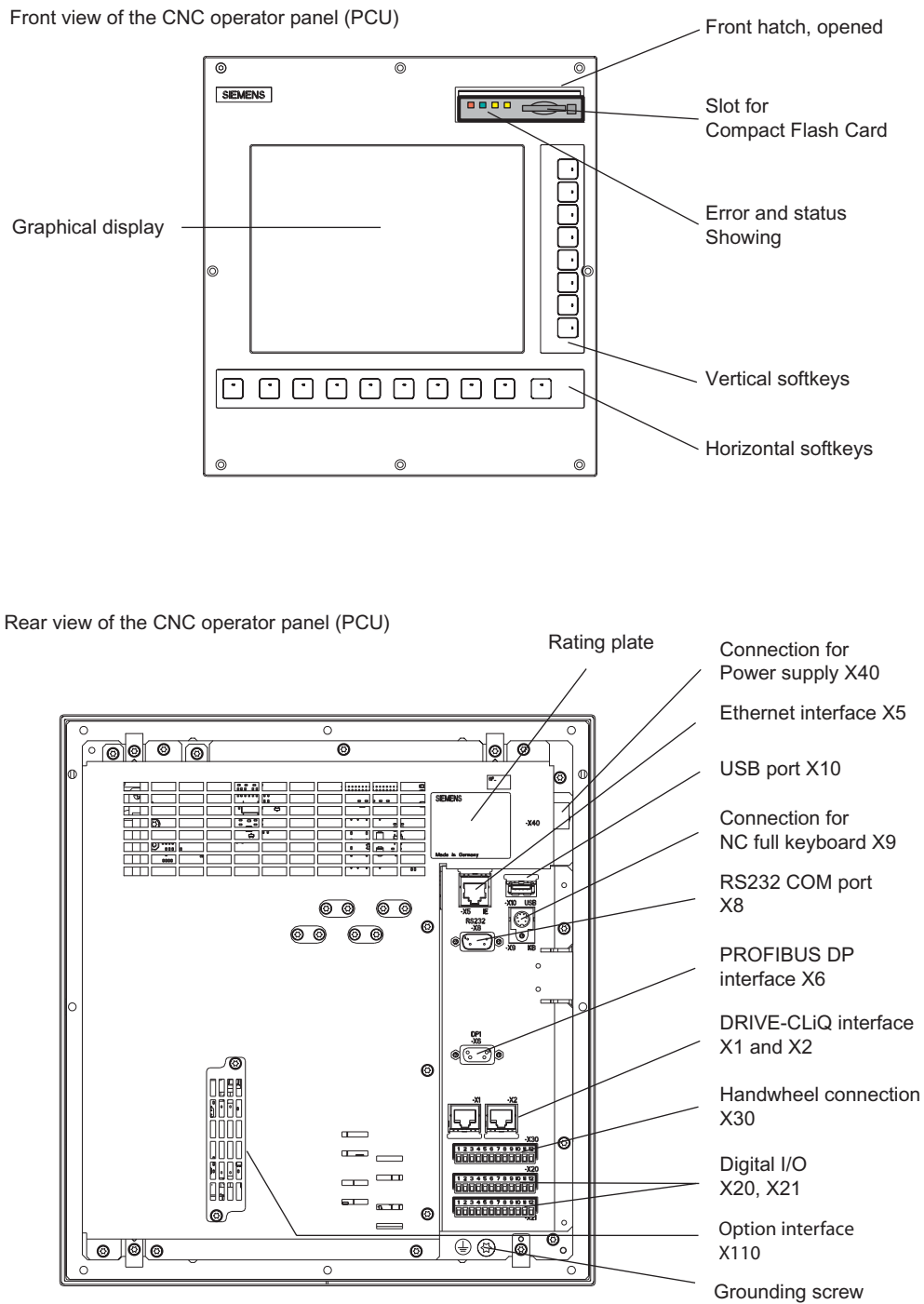

Figure 1-3 Position of the interfaces and front elements on the CNC operator panel

CNC operator panel (PCU) interfaces

The PCU and its functions are described in the table below.

Table 1-1 PCU interfaces

interfaces	Function
Compact flash card (CF card) slot	50-pin slot for CF cards, and 4 LEDs
Power supply connection X40	3-pin screw-type terminal connection for connecting the 24 V load power supply
Ethernet interface X5	8-pin RJ45 socket connector for connection to an Industrial Ethernet
USB interface X10	4-pin USB port for connecting USB accessories (available soon)
NC full keyboard connection X9	6-pin PS/2 socket for connecting the NC full keyboard
RS232 COM interface X8	9-pin DSub connector for connecting a PG/PC
PROFIBUS DP interface X6	9-pin DSub socket for connection to PROFIBUS DP
DRIVE-CLiQ interface X1 and X2	8-pin RJ45 socket for connecting the SINAMICS S120 drive
Handwheel connection X30	12-pin screw-type male connector for connecting a max. of 2 handwheels
Digital inputs/digital outputs X20 and X21	12-pin screw-type male connector for connecting the digital inputs and outputs
Option interface X110	48-pin female connector for connecting the MCPA module

interfaces

2.1 CNC operator panel interfaces

2.1.1 Compact flash card (CF card) slot

Only type 1 compact flash cards can be used.

The compact flash card can be used, for example:

- for start-up data
- for NC programs
- to carry out software updates
- to store user data
- to save parameters which have been set by the user.

2.1.2 Ethernet interface

A PG/PC can be connected to the Ethernet interface via a Industrial Ethernet network. The device connected must possess an Ethernet card and the appropriate software.

Industrial Ethernet is a communication network providing a transmission rate of 10/100 Mbps.

Female connector pin assignment

Identifiers: **X5(IE)**

Type: 8-pin RJ45 socket

Table 2-1 Pin assignment of female connector X5

Schematic view of the female connector, mounting position and labeling	Pin	Name	Description
	1	TXP	Transmit data +
	2	TXN	Transmit data -
	3	RXP	Receive data +
	4	not assigned	-
	5	not assigned	-

2.1 CNC operator panel interfaces

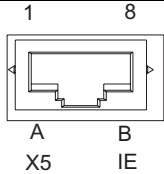
Schematic view of the female connector, mounting position and labeling	Pin	Name	Description
	6	RXN	Receive data -
	7	not assigned	-
	8	not assigned	-
For additional information about the cabling options for Ethernet, contact your SIEMENS representative.			

2.1.3 USB port (available soon)

2.1.4 RS232 COM port

A PC / programming device (PG) for data exchange with the CNC operator panel can be connected to male connector X8.

Connector pin assignment

Identifiers: **X8 (RS232)**
 Type: 9-pin D-Sub terminal strip

Table 2-2 Pin assignment of connector X8

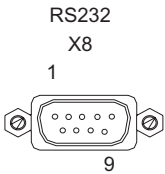
Schematic view of the female connector, mounting position and labeling	Pin	Name	Description	
			German/English:	
	1	DCD	Received Line Signal Detector Carrier Detector	Data carrier detect
	2	RxD	Received Data	Received data
	3	TxD	Transmitted Data	Transmitted data
	4	DTR	Data Terminal Ready	Data Terminal Ready
	5	G	Ground	Ground
	6	DSR	Data Set Ready	Data Set Ready
	7	RTS	Request To Send	Transmission request
	8	CTS	Clear To Send	Ready to send

Schematic view of the female connector, mounting position and labeling	Pin	Name	Description German/English:	
	9	not assigned	-	-

2.1.5 PROFIBUS DP interface

The CNC operator panel (PCU) communicates with the I/O modules via the PROFIBUS DP interface.

The **PROFIBUS DP** protocol is used for communications.

The baud rate of the PROFIBUS DP interface is 12 Mbit/s; the baud rate cannot be changed. Converters for optical fiber cable (OLMs, OLPs) or repeaters are not permitted.

The operator panel CNC provides master functionality.

Female connector pin assignment

Designation: **X6 (DP1)**

Type: 9-pin D-Sub socket connector

Table 2-3 Pin assignment of female connector X6

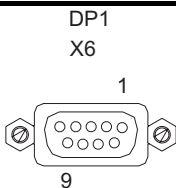
Schematic view of the female connector, mounting position and labeling	Pin	Name	Description
	1	not assigned	-
	2	M24	
	3	B	Data input/output (RS485)
	4	RTS	Transmission request
	5	M5	5 V reference potential
	6	P5	5 V power supply 90 mA, short-circuit-proof
	7	P24	24V power supply (teleservice) 150mA, short-circuit-proof, not isolated
	8	A	Data input/output (RS485)
	9	not assigned	-

2.1.6 DRIVE-CLiQ interface

The CNC operator panel (PCU) can communicate with the "SINAMICS S" drive via the DRIVE CLiQ interface.

Female connector pin assignment

Designation: **X1, X2**
 Type: 8-pin RJ45 socket

Table 2-4 Pin assignment of female connector X1 and X2

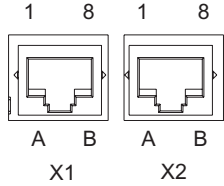
Schematic view of the female connector, mounting position and labeling	Pin	Name	Description
	1	TXP	Transmit data +
	2	TXN	Transmit data -
	3	RXP	Receive data +
	4	not assigned	-
	5	not assigned	-
	6	RXN	Receive data -
	7	not assigned	-
	8	not assigned	-
	A	not assigned	-
	B	not assigned	-

Blanking plate for DRIVE CLiQ interface: Molex corp., order no. 85999-3255

2.1.7 Handwheel connection

Max. 2 electronic handwheels can be connected to connector X30 on the CNC operator panel (PCU).

The handwheel must meet the following requirements:

- Transmission procedure: 5 V square wave signals (TTL level or RS422)
- Signals: Track A as a true and negated signal (U_{a1} , U_{a1})
 Track B as a true and negated signal (U_{a2} , U_{a2})
- Max. output frequency: 500 kHz
- Phase shift of Track A to Track B: $90^\circ \pm 30^\circ$
- Supply: 5 V, max. 250 mA

Connector pin assignment

Designation: **X30**
 Type: 12-pin connector

Table 2-5 Pin assignment of connector X30

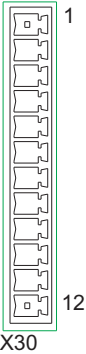
Schematic view of the connector	Pin	Name	Description
	1	3P5	5VDC supply voltage
	2	G	Ground
	3	1A	Track A, handwheel 1
	4	X1A	Track A_N, handwheel 1
	5	1B	Track B, handwheel 1
	6	X1B	Track B_N, handwheel 1
	7	3P5	5VDC supply voltage
	8	G	Ground
	9	2A	Track A, handwheel 2
	10	X2A	Track A_N, handwheel 2
	11	2B	Track B, handwheel 2
	12	X2B	Track B_N, handwheel 2

2.1.8 Digital inputs/outputs

You can implement the circuit of the SINAMICS drives via digital inputs and digital outputs at connectors X20 and X21.

A maximum of 16 or 8 digital inputs and 8 digital outputs can be used.

Wiring and block diagrams

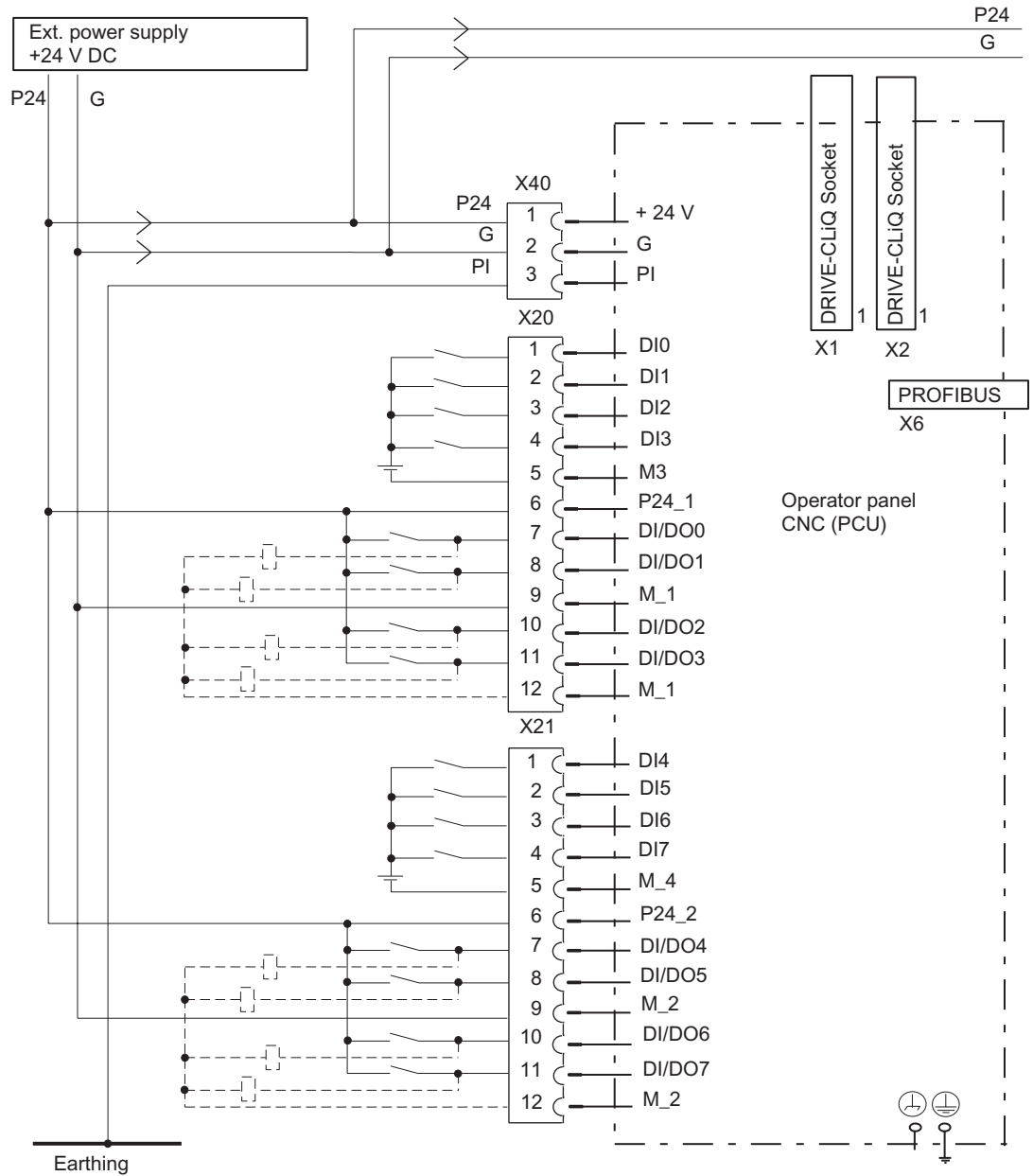
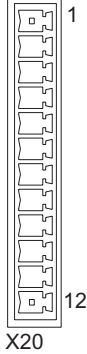
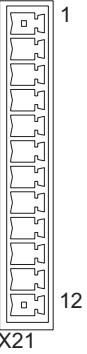
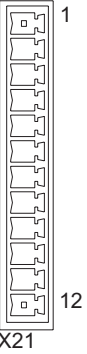
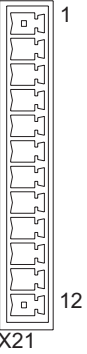

Figure 2-1 Connection example

Connector pin assignment

Designation: X20, X21
 Type: 12-pin connector

Table 2-6 Pin assignment of the connectors X20 and X21

Representation	Pin	Name	Description	Technical details	
 <p>X20</p>	1	DI0	Digital input 0	Input: Voltage: 24VDC (20.4 ... 28.8V) Level: 0 signal: -3...5 V 1 signal: 11...30 V Input delay: 0 → 1 signal: 15 μs (typically 6) 1 → 0 signal: 150 μs (typically 40)	
	2	DI1	Digital input 1		
	3	DI2	Digital input 2		
	4	DI3	Digital input 3		
	5	M_3	Ground for DI0...DI3		
	 <p>X21</p>	6	P24_1	24VDC Supply voltage for DI/DO0...DI/DO3 (required for digital outputs)	For the output: max. output current: 1 signal: 5 mA ... 0.5 A Total current of all outputs: max. 2 A (in case of simultaneous occurrence 50 %) Output delay: 0 → 1 signal: 500 μs (typically 150 μs) 1 → 0 signal: 500 μs (typ. 150 μs) each for RL = 60 Ohms switching frequency: 100 Hz (ohmic load) 2 Hz (inductive load) For the input: Data see connector X21
		7	DI/DO0	Digital I/O	
		8	DI/DO1	Digital I/O	
		9	M_1	Ground for DI/DO0...DI/DO3	
		10	DI/DO2	Digital I/O	
		11	DI/DO3	Digital I/O	
		12	M_1	Ground for DI/DO0...DI/DO3	
 <p>X20</p>	1	DI4	Digital input 4	Input: for the data, see connector X20	
	2	DI5	Digital input 5		
	3	DI6	Digital input 6		
	4	DI7	Digital input 7		
	5	M_4	Ground for DI4...DI7		
	 <p>X21</p>	6	P24_2	24VDC supply voltage for DI/DO4...DI/DO7 (required for digital outputs)	Output: for the data, see connector X20 Input: Voltage: 24VDC (20.4 ... 28.8V) Level: 0 signal: -3...5 V 1 signal: 11...30 V Input delay: 0 → 1 signal: 15 μs (typically 6) 1 → 0 signal: 150 μs (typically 40)
		7	DI/DO4	Digital I/O	
		8	DI/DO5	Digital I/O	
		9	M_2	Ground for DI/DO4...DI/DO7	
		10	DI/DO6	Digital I/O	
		11	DI/DO7	Digital I/O	
		12	M_2	Ground for DI/DO4...DI/DO7	



Danger

The 24 V power supply is to be designed as functional extra-low voltage with protective separation in accordance with EN60204–1, Section 6.4, PELV (with G ground).

Digital inputs (PCU)

These high-speed inputs correspond to Standard IEC 1131-2/DIN EN 61131-2, characteristic curve type 2 (24 V-P-switching). Switches or proximity encoders (2- or 3-wire encoders) can be connected.

Digital outputs (PCU)

These high-speed outputs (onboard) correspond to Standard IEC 1131-2/DIN EN 61131-2 (24 V-P-switching).

See also

Setting the Profibus addresses (Page 90)

2.2 MCPA module interfaces

Overview

The illustration below shows the MCPA module with its interfaces and the status display.

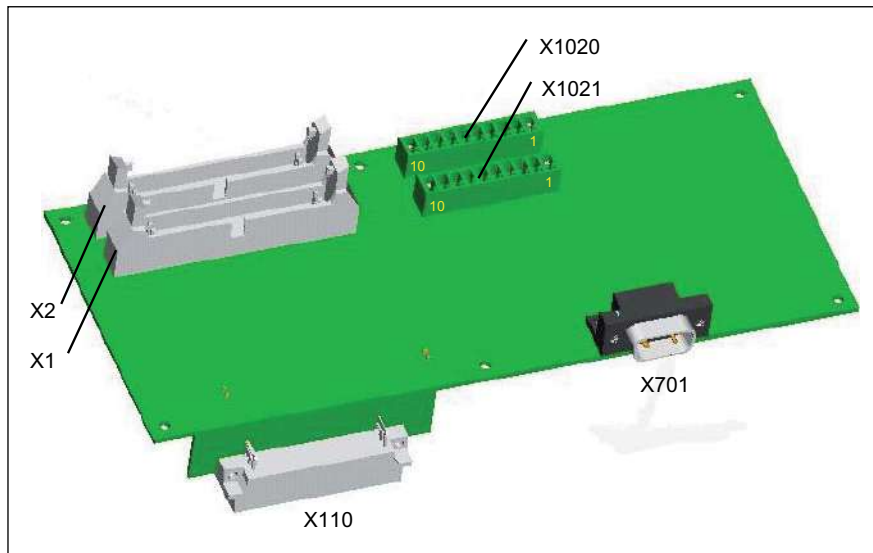

Figure 2-2 Position of the interfaces and of the status display on the MCPA module

Table 2-7 Interfaces and status display

interfaces	Function
Interface for MCP 802D sl X1 and X2	40-pin plug connectors for connecting the machine control panel (MCP)
I/O interface X1020 and X1021	10-pin plug connectors for connection of the power supply and of the high-speed digital inputs and outputs
Analog spindle connection X701	9-pin D-Sub connector for connecting an analog spindle with directly mounted spindle actual-value encoder
Interface to the PCU X110	48-pin plug connectors for connecting the MCPA module to the PCU

Assignment of the interface to the MCP 802D sl

Designation: **X1, X2**

Type: 40-pin ribbon cable connector

Table 2-8 Pin assignment of connectors X1 and X2

X1					
Pin	Name	Description	Pin	Name	Description
1	KEY1	Input bit	2	KEY2	Input bit
3	KEY3	Input bit	4	KEY4	Input bit
5	KEY5	Input bit	6	KEY6	Input bit
7	KEY7	Input bit	8	KEY8	Input bit
9	GND		10	KEY9	Input bit
11	KEY10	Input bit	12	KEY11	Input bit
13	KEY12	Input bit	14	KEY13	Input bit
15	KEY14	Input bit	16	KEY15	Input bit
17	KEY16	Input bit	18	GND	
19	KEY17	Input bit	20	KEY18	Input bit
21	KEY19	Input bit	22	KEY20	Input bit
23	KEY21	Input bit	24	KEY22	Input bit
25	KEY23	Input bit	26	KEY24	Input bit
27	GND		28	LED1	Output bit
29	LED2	Output bit	30	LED3	Output bit
31	LED4	Output bit	32	LED5	Output bit
33	LED6	Output bit	34	not assigned	-
35	not assigned	-	36	GND	
37	not assigned	-	38	not assigned	-
39	not assigned	-	40	not assigned	-

X2					
Pin	Name	Description	Pin	Name	Description
1	KEY25	Input bit	2	KEY26	Input bit



X2					
3	KEY27	Input bit	4	not assigned	-
5	not assigned	-	6	not assigned	-
7	not assigned	-	8	not assigned	-
9	GND		10	FEED_OV_A	Input bit
11	FEED_OV_B	Input bit	12	FEED_OV_C	Input bit
13	FEED_OV_D	Input bit	14	FEED_OV_E	Input bit
15	not assigned	-	16	not assigned	-
17	not assigned	-	18	GND	
19	SPINDLE_OV_A	Input bit	20	SPINDLE_OV_B	Input bit
21	SPINDLE_OV_C	Input bit	22	SPINDLE_OV_D	Input bit
23	SPINDLE_OV_E	Input bit	24	not assigned	-
25	not assigned	-	26	not assigned	-
27	not assigned	-	28	not assigned	-
29	not assigned	-	30	not assigned	-
31	not assigned	-	32	not assigned	-
33	not assigned	-	34	not assigned	-
35	not assigned	-	36	GND	
37	not assigned	-	38	not assigned	-
39	not assigned	-	40	not assigned	-

Assignment of the I/O interface connectors

Designation: X1020, X1021

Type: 10-pin connector

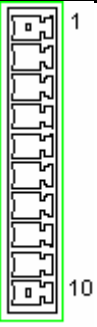
Table 2-9 Pin assignment of the connectors X1020 and X1021

Representation	Pin	Name	Description
 X1020	1		
	2	DI0	high-speed digital input 0
	3	DI1	high-speed digital input 1
	4	DI2	high-speed digital input 2
	5	DI3	high-speed digital input 3
	6	DI4	high-speed digital input 4
	7	DI5	high-speed digital input 5
	8	DI6	high-speed digital input 6
	9	DI7	high-speed digital input 7
	10		Chassis ground
	1	P24	24VDC supply voltage
	2	Q0	high-speed digital output 0
	3	Q1	high-speed digital output 1
	4	Q2	high-speed digital output 2

Representation	Pin	Name	Description
	5	Q3	high-speed digital output 3
	6	Q4	high-speed digital output 4
	7	Q5	high-speed digital output 5
	8	Q6	high-speed digital output 6
	9	Q7	high-speed digital output 7
	10	G	Ground

Connector pin assignment (analog output to the drive)

Designation: X701

Type: 9-pin D-Sub terminal strip

Table 2-10 Pin assignment of connector X701

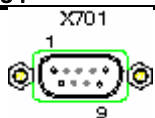
Schematic view of the female connector, mounting position and labeling	Pin	Name	Description German
	1	Analog OUT	Analog output with a signal level of ±10 V Resolution 11 bits + sign
	2	not assigned	-
	3	Uni-Dir2	Digital output for unipolar spindle +24 V
	4	Uni-Dir1	Digital output for unipolar spindle +24 V
	5	Enable 1-	Analog drive enable (contact: electrically isolated n.o. contact)
	6	Analog OUT	Analog output 0 V Reference signal
	7	not assigned	-
	8	not assigned	-
	9	Enable 2-	Analog drive enable (contact: electrically isolated n.o. contact)

2.3 Interfaces of the machine control panel MCP 802D sl

The illustration below shows the back of the machine control panel MCP 802D sl with its interfaces.

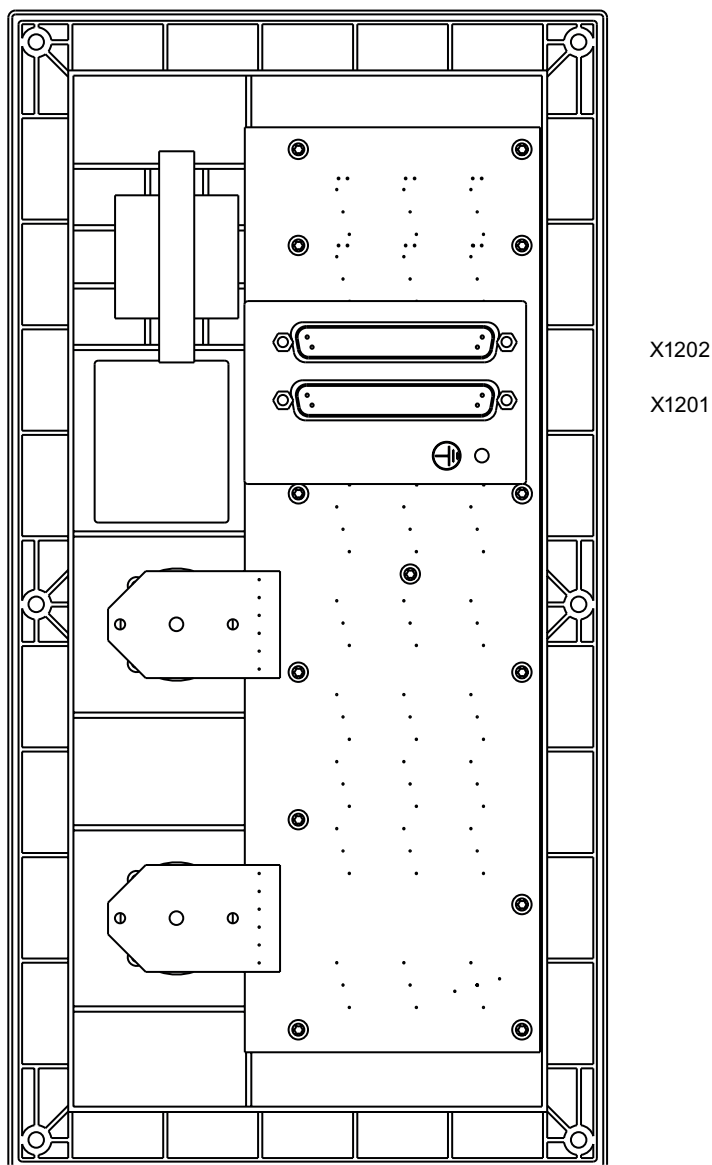

Figure 2-3 Interfaces at the MCP 802D sl

Table 2-11 Interfaces

Interfaces	Function
Interface X1201	40-pin D-Sub connector for connecting the machine control panel to the MCPA module X1
Interface X1202	40-pin D-Sub connector for connecting the machine control panel to the MCPA module X2

Interface assignments

Designation: X1201, X1202
 Type: 40-pin D-Sub connector

Table 2-12 Pin assignment of the connectors X1201 and X1202

X1201					
Pin	Name	Description	Pin	Name	Description
1	KEY1	Input bit	2	KEY2	Input bit
3	KEY3	Input bit	4	KEY4	Input bit
5	KEY5	Input bit	6	KEY6	Input bit
7	KEY7	Input bit	8	KEY8	Input bit
9	GND		10	KEY9	Input bit
11	KEY10	Input bit	12	KEY11	Input bit
13	KEY12	Input bit	14	KEY13	Input bit
15	KEY14	Input bit	16	KEY15	Input bit
17	KEY16	Input bit	18	GND	
19	KEY17	Input bit	20	KEY18	Input bit
21	KEY19	Input bit	22	KEY20	Input bit
23	KEY21	Input bit	24	KEY22	Input bit
25	KEY23	Input bit	26	KEY24	Input bit
27	GND		28	LED1	Output bit
29	LED2	Output bit	30	LED3	Output bit
31	LED4	Output bit	32	LED5	Output bit
33	LED6	Output bit	34	not assigned	-
35	not assigned	-	36	GND	
37	not assigned	-	38	not assigned	-
39	not assigned	-	40	not assigned	-

X1202					
1	KEY25	Input bit	2	KEY26	Input bit
3	KEY27	Input bit	4	not assigned	-
5	not assigned	-	6	not assigned	-
7	not assigned	-	8	not assigned	-
9	GND		10	FEED_OV_A	Input bit
11	FEED_OV_B	Input bit	12	FEED_OV_C	Input bit
13	FEED_OV_D	Input bit	14	FEED_OV_E	Input bit
15	not assigned	-	16	not assigned	-
17	not assigned	-	18	GND	
19	SPINDLE_OV_A	Input bit	20	SPINDLE_OV_B	Input bit
21	SPINDLE_OV_C	Input bit	22	SPINDLE_OV_D	Input bit
23	SPINDLE_OV_E	Input bit	24	not assigned	-
25	not assigned	-	26	not assigned	-
27	not assigned	-	28	not assigned	-
29	not assigned	-	30	not assigned	-
31	not assigned	-	32	not assigned	-
33	not assigned	-	34	not assigned	-

X1202					
35	not assigned	-	36	GND	
37	not assigned	-	38	not assigned	-
39	not assigned	-	40	not assigned	-

2.4 PP 72/48 I/O module interfaces

The diagrams below show the interfaces, the operator controls and displays, as well as in the example the possibilities of connection to the I/O interface of the I/O module.

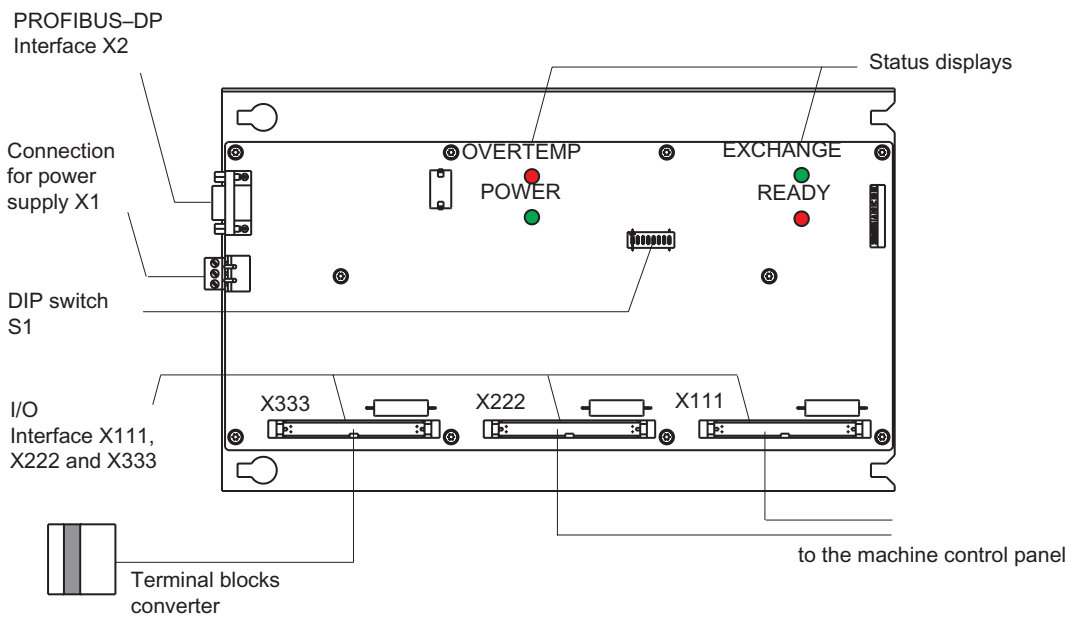

Figure 2-4 Position of the interfaces and status displays on the I/O module with connection to the MCP and a terminal strip converter

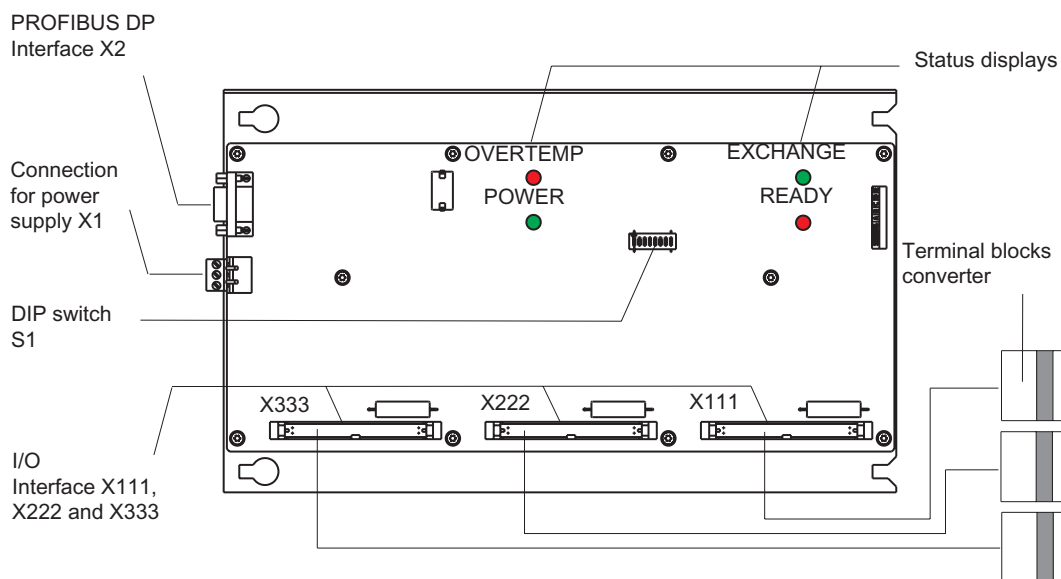

Figure 2-5 Position of the interfaces and status displays on the I/O module when connecting 3 terminal strip converters

PP 72/48 interfaces

The interfaces and the operator controls of the PP 72/48 I/O module and their functions are described in the table below.

Table 2-13 Interfaces

Interfaces	Function
PROFIBUS DP interface	9-pin DSub socket X2 for connection to PROFIBUS DP
Power supply connection	3-pin screw-type terminal connection X1 for connecting the 24 V load power supply
I/O interface	50-pin plug connectors X111 , X222 , X333 for connecting the machine control panel or the terminal strip converters for the digital inputs/outputs
DIL switch	DIL switch S1 for setting the PROFIBUS DP address

PROFIBUS DP interface X2

The **PROFIBUS DP** protocol is used for communications.

The baud rate of the PROFIBUS DP interface is 12 Mbps.

The PP 72/48 I/O module provides slave functionality.

Female connector pin assignment

Designation: **X2**

Type: 9-pin D-Sub socket connector

Table 2-14 Female connector X2 pin assignment

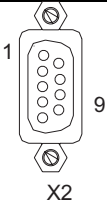
Schematic view of the connector	Pin	Name	Description
	1	not assigned	-
	2	not assigned	-
	3	B	Data input/output (RS485)
	4	RTS	Transmission request
	5	M5	5 V reference potential
	6	P5	5 V power supply 90 mA, short-circuit-proof
	7	not assigned	-
	8	A	Data input/output (RS485)
	9	not assigned	-

I/O interface

The following devices can be connected to the connectors X111, X222 and X333 (50-pin ribbon-cable plug):

- either one machine control panel (MCP) and one terminal strip converter for digital inputs/digital outputs
- or
- three terminal strip converter for digital inputs and digital outputs

The terminal strip converters are connected to the PP 72/48 I/O module via ribbon cable. The individual wiring can be performed at the terminal strips according to your particular application.

Connector pin assignment

Designation: X111, X222, X333
 Type: 50-pin ribbon cable connector

Table 2-15 Pin assignment of the connectors X111, X222, X333

Pin	Name	Description	Pin	Name	Description
1	G	Ground	2	P24OUT _{INT}	24VDC, internal supply voltage for the inputs
3	DI m+0.0	Input bit	4	DI m+0.1	Input bit
5	DI m+0.2	Input bit	6	DI m+0.3	Input bit
7	DI m+0.4	Input bit	8	DI m+0.5	Input bit
9	DI m+0.6	Input bit	10	DI m+0.7	Input bit
11	DI m+1.0	Input bit	12	DI m+1.1	Input bit
13	DI m+1.2	Input bit	14	DI m+1.3	Input bit
15	DI m+1.4	Input bit	16	DI m+1.5	Input bit
17	DI m+1.6	Input bit	18	DI m+1.7	Input bit
19	DI m+2.0	Input bit	20	DI m+2.1	Input bit
21	DI m+2.2	Input bit	22	DI m+2.3	Input bit

Pin	Name	Description	Pin	Name	Description
23	DI m+2.4	Input bit	24	DI m+2.5	Input bit
25	DI m+2.6	Input bit	26	DI m+2.7	Input bit
27	not assigned	-	28	not assigned	-
29	not assigned	-	30	not assigned	-
31	DO n+0.0	Output bit	32	DO n+0.1	Output bit
33	DO n+0.2	Output bit	34	DO n+0.3	Output bit
35	DO n+0.4	Output bit	36	DO n+0.5	Output bit
37	DO n+0.6	Output bit	38	DO n+0.7	Output bit
39	DO n+1.0	Output bit	40	DO n+1.1	Output bit
41	DO n+1.2	Output bit	42	DO n+1.3	Output bit
43	DO n+1.4	Output bit	44	DO n+1.5	Output bit
45	DO n+1.6	Output bit	46	DO n+1.7	Output bit
47	DOCOMx ¹⁾	24VDC supply voltage for the outputs	48	DOCOMx ¹⁾	24VDC supply voltage for the outputs
49	DOCOMx ¹⁾		50	DOCOMx ¹⁾	

¹⁾x = 1 for connector X111; x = 2 for connector X222; x = 3 for connector X333
m = 0 for connector X111; m = 3 for connector X222; m = 6 for connector X333
n = 0 for connector X111; n = 2 for connector X222; n = 4 for connector X333



Danger

The 24 V power supply is to be designed as functional extra-low voltage with protective separation in accordance with EN60204–1, Section 6.4, PELV (with G ground).

Note

The connection cable between the voltage source, the load current supply connector and the associated reference potential G should **not** exceed a maximum length of 10 m.

Digital inputs

The diagram below shows the connector pin assignment for the digital inputs at connection X111 (example). Connectors X222 and X333 are assigned analogously.

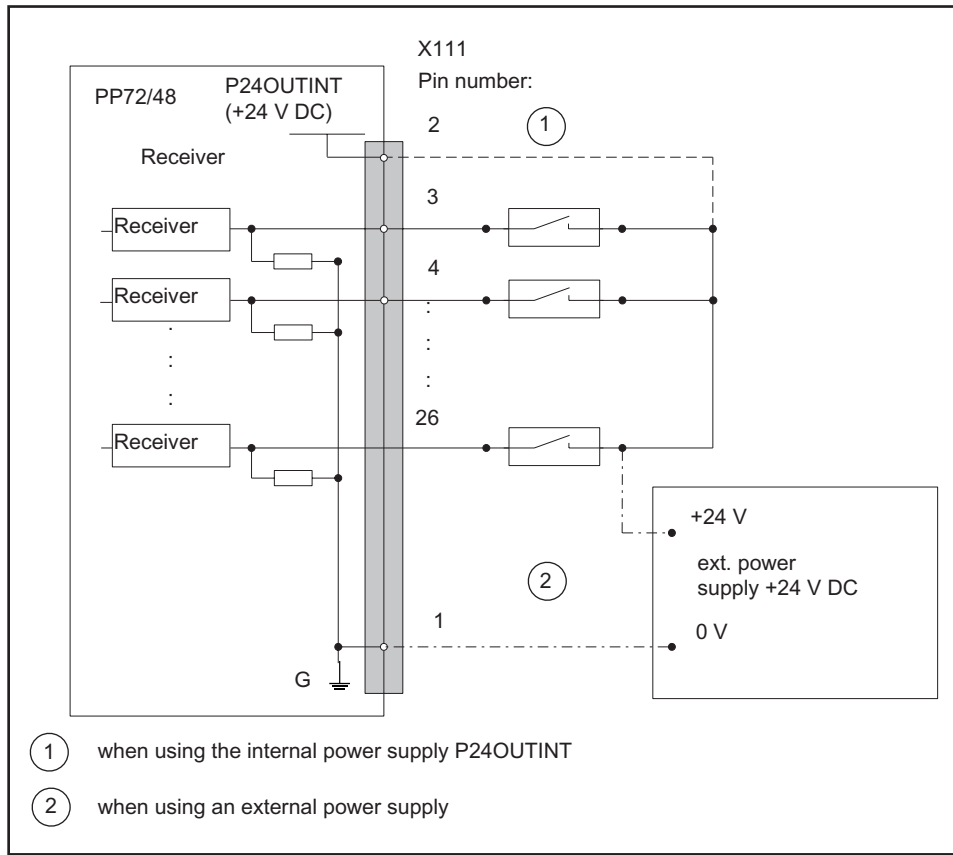

Figure 2-6 Terminal assignment for the digital inputs

Internal power supply (P24OUTINT)

The internal power supply for the digital inputs (X111, X222, X333: pin 2) is taken from the general power supply of module X1, pin 2 (P24).



Caution

Make sure that a max. current of $I_{out} = 0.25 \text{ A}$ at X111, X222, X333 on pin 2 is not exceeded. An exceeding of the maximum current might destroy the module.

External power supply

If an external power supply is used for the digital inputs, their reference ground must be connected to X111, X222, X333: Pin 1 (G).

X111, X222, X333: Pin 1 (P24OUT_{INT}) remains open.

Digital outputs

The diagram below shows the connector pin assignment for the digital outputs at connection X111 (example). Connectors X222 and X333 are assigned analogously.

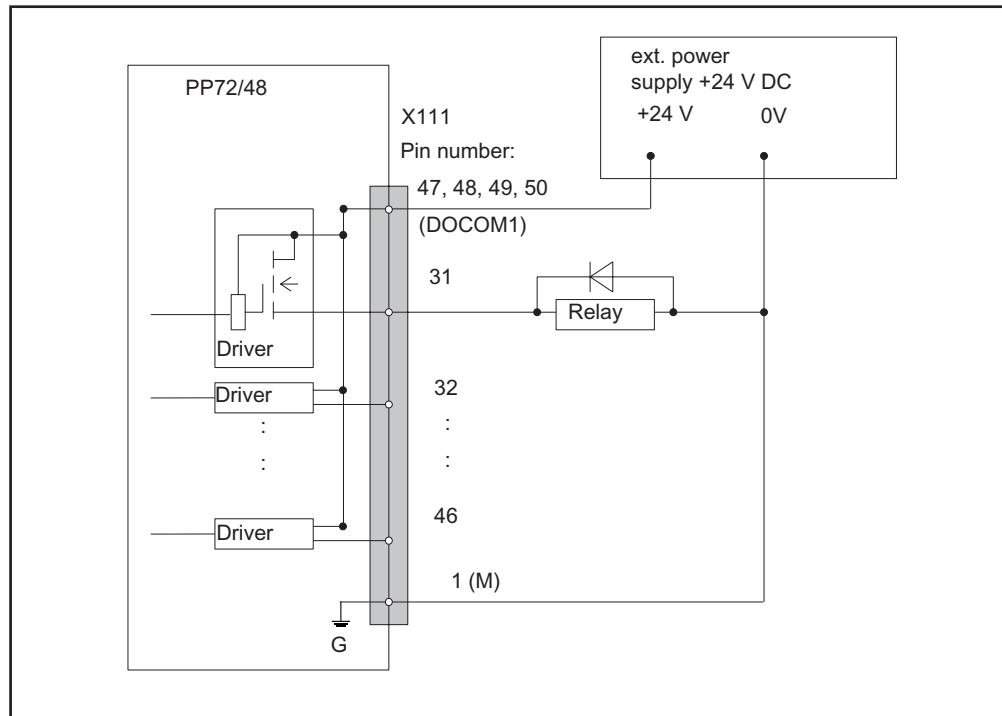

Figure 2-7 Terminal assignment for the digital outputs

To supply the digital outputs, an external 24VDC power supply must be connected to DOCOMx (X111, X222, X333: pins 47, 48, 49, 50).

The reference ground of the external power supply source must be connected to X111, X222, X333: Pin 1 (G).



Caution

It is the user's responsibility to ensure that the max. current consumption per DOCOMx pin (X111, X222, X333: pins 47 through 50) does **not** exceed 1 A.

It is imperative to connect the 24 V power supply for the digital outputs for DOCOMx to **all four pins** (X111, X222, X333: **pins 47 through 50**).



Danger

The 24 V power supply is to be designed as functional extra-low voltage with protective separation in accordance with EN60204-1, Section 6.4, PELV (with G ground).

2.5 Interfaces of the machine control panel MCP

The illustration below shows the back of the machine control panel MCP with its interfaces.

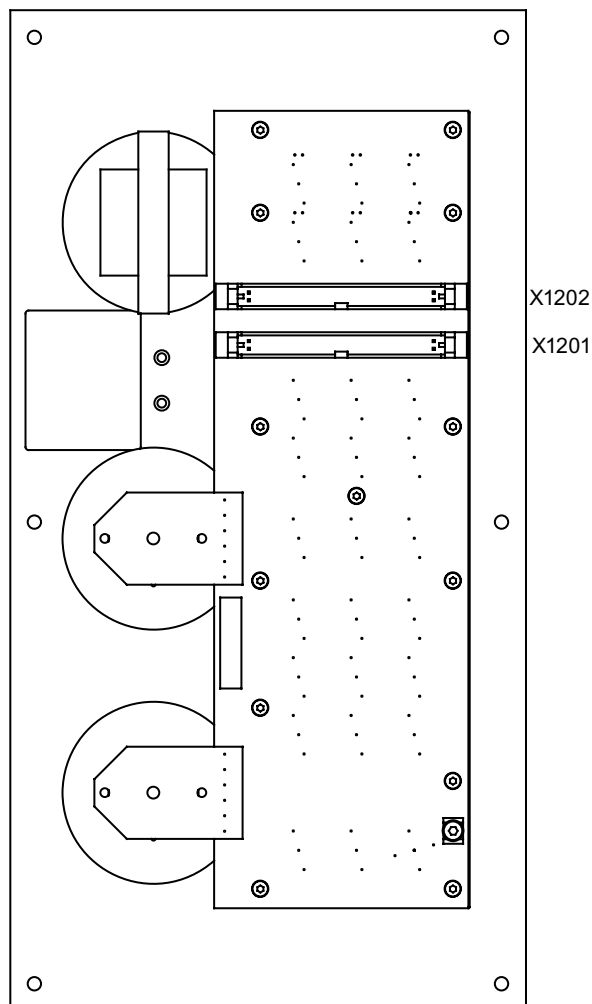

Figure 2-8 Interfaces on the MCP

Table 2-16 Interfaces

Interfaces	Function
Interface X1201	50-pin ribbon-cable plug for connecting the machine control panel to the PP module
Interface X1202	50-pin ribbon-cable plug for connecting the machine control panel to the PP module

Interface assignments

Designation: X1201, X1202

Type: 50-pin ribbon cable connector

Table 2-17 Pin assignment of the connectors X1201 and X1202

X1201					
Pin	Name	Description	Pin	Name	Description
1	GND		2	+24V	
3	KEY1	Input bit	4	KEY2	Input bit
5	KEY3	Input bit	6	KEY4	Input bit
7	KEY5	Input bit	8	KEY6	Input bit
9	KEY7	Input bit	10	KEY8	Input bit
11	KEY9	Input bit	12	KEY10	Input bit
13	KEY11	Input bit	14	KEY12	Input bit
15	KEY13	Input bit	16	KEY14	Input bit
17	KEY15	Input bit	18	KEY16	Input bit
19	KEY17	Input bit	20	KEY18	Input bit
21	KEY19	Input bit	22	KEY20	Input bit
23	KEY21	Input bit	24	KEY22	Input bit
25	KEY23	Input bit	26	KEY24	Input bit
27	not assigned	-	28	not assigned	-
29	not assigned	-	30	not assigned	-
31	LED1	Output bit	32	LED2	Output bit
33	LED3	Output bit	34	LED4	Output bit
35	LED5	Output bit	36	LED6	Output bit
37		Output bit	38		Output bit
39		Output bit	40		Output bit
41		Output bit	42		Output bit
43		Output bit	44		Output bit
45		Output bit	46		Output bit
47	24VDC	24VDC	48	24VDC	24VDC
49	24VDC	24VDC	50	24VDC	24VDC

X1202					
Pin	Name	Description	Pin	Name	Description
1	GND		2	+24V	
3	KEY25	Input bit	4	KEY26	Input bit
5	KEY27	Input bit	6		Input bit
7		Input bit	8		Input bit
9		Input bit	10		Input bit
11	Feed_OV_A	Input bit	12	Feed_OV_B	Input bit
13	Feed_OV_C	Input bit	14	Feed_OV_D	Input bit
15	Feed_OV_E	Input bit	16		Input bit
17		Input bit	18		Input bit
19	Sp-OV-A	Input bit	20	Sp-OV-B	Input bit
21	Sp-OV-C	Input bit	22	Sp-OV-D	Input bit

X1202					
Pin	Name	Description	Pin	Name	Description
23	Sp-OV-E	Input bit	24		Input bit
25		Input bit	26		Input bit
27	not assigned	-	28	not assigned	-
29	not assigned	-	30	not assigned	-
31		Output bit	32		Output bit
33		Output bit	34		Output bit
35		Output bit	36		Output bit
37		Output bit	38		Output bit
39		Output bit	40		Output bit
41		Output bit	42		Output bit
43		Output bit	44		Output bit
45		Output bit	46		Output bit
47	24VDC	24VDC	48	24VDC	24VDC
49	24VDC	24VDC	50	24VDC	24VDC

2.6 Interfaces of the DP/DP coupler

Note

You can find information on the DP/DP coupler in the "SIMASTIC, DP/DP coupler" manual.

Application planning

3.1 Overview

Basic Rules

The present chapter describes various general rules for electrical design. You must observe these rules to ensure trouble-free operation.

Safety regulations

To ensure safe operation of your plant, realize the following measures and adapt them to your particular conditions:

- An EMERGENCY OFF concept in accordance with the generally accepted rules of current engineering practice (e.g., European Standards EN 60204, EN 418 and similar).
- additional measures for the limiting of limit positions of axes (e.g. hardware limit switches).
- Equipment and measures for protection of motors and power electronics in accordance with the SINAMICS Installation Guidelines.

In addition, in order to identify hazards, we recommend that a risk analysis be conducted on the entire system in accordance with the basic safety requirements set out in Appendix 1 of EU Machinery Directive 89/392/EEC.

Also note in this regard the Chapter "ESD Guidelines" in the Appendix of this manual.

Additional references

For further information about EMC guidelines, we recommend the publication: **EMC Installation Guideline, Planning Guide (HW)**

References: /EMC/, Description

Standards and regulations

When connecting SINUMERIK 802D sl, please observe the relevant VDE guidelines, in particular VDE 0100 or VDE 0113 for disconnecting devices, short-circuit and overload protection.

3.2 General rules for operation of a SINUMERIK 802D sl

When integrating a SINUMERIK 802D sl into a plant, you must observe the following general rules.

Starting the plant after certain events

If ...	then ...
Startup after voltage drop or power failure	All hazardous operating conditions must be avoided. If necessary, force an EMERGENCY STOP.
A startup after unlocking the EMERGENCY-OFF equipment	no uncontrolled or undefined start must occur.

Mains voltage

At ...	make sure that ...
Stationary plants or systems without all-pole line voltage disconnect switch	the building installation must be equipped with a power disconnect switch or a fuse.
load power supplies, power supply modules	the set range of the rated voltage complies with the local mains voltage.
all current circuits	deviation of the line voltage from the rated value must be within the permitted tolerance (refer to "Technical data of the installed components").

24VDC power supply

At ...	ensure ...
24 V power supply	Safe (electrical) isolation of low voltage

Protection against external electrical interference

At ...	make sure that ...
all plants, installations and systems in which SINUMERIK is installed	the plant or system is connected to the protective conductor for diverting electromagnetic interference.
supply, signal, and bus lines	The wiring arrangement and installation complies with EMC regulations.
signal and bus cables	a wire break or conductor break does not result in undefined states of the plant or system.

3.3 Rules regarding current consumption and power loss of a cubicle arrangement

The power loss of **all** components used in a cabinet must not exceed the maximum amount that can be dissipated from the cabinet.

Note

When dimensioning the control cubicle, make sure that the permissible ambient temperature is not exceeded for the components installed, even in case of high outside temperatures.

For the current consumption and the power loss of the individual modules, please refer to Chapter, "Technical Specifications".

Assembling

Overview

To install **SINUMERIK 802D sl**, first secure the individual components on the site of installation and then connect them with each other.

Open Equipment

The modules of **SINUMERIK 802D sl** are open-type equipment. This means that you are only allowed to install SINUMERIK 802D sl in housings, cubicles or electrical service rooms. Access to these housings, cubicles or electrical service rooms must only be possible using a key or a tool and must be restricted to instructed or authorized personnel.

General procedure when installing SINUMERIK 802D solution line



Warning

Before installing or removing the components of the SINUMERIK 802D sl control system, make sure that the system is disconnected from the mains.

Note

When installing the control components, observe the dimensions given in Chapter "Dimension Drawings". The drilling patterns constitute the basis for preparing the mounting holes.

Mounting the CNC operator panel (PCU)

Install the CNC operator panel as shown on the relevant illustrations and diagrams in Chapter "Dimension Drawings".



Caution

If you do not have access to the back of the controller during installation, you must connect the CNC operator panel prior to its installation. When doing so, note that connector X40 (power supply connection) and the lines connected to it protrude beyond the mounting edge.

When installing the CNC operator panel, do not pull off the connector; otherwise, the cables could be damaged!

Installing the machine control panel

Install the machine control panel as shown on the relevant illustrations and diagrams in Chapter "Dimension Drawings".

Installing the CNC full keyboard

You can install the CNC full keyboard either next to the operator panel or beneath the CNC operator panel. Observe the specifications in the illustrations in Chapter "Dimension Drawings".

Installing the PP72/48 I/O module

The module must be installed according to EN 60204. Dimension drawing of the module, see Chapter "Dimension Drawings".

Installing the SINAMICS S120 drive

For information regarding the **SINAMICS S120** drive system (design, connection, planning, dimensioning, configuring, etc.), see:

References: /GH1/, /GH2/, Equipment Manuals

Connecting

5.1 Overall design of the SINUMERIK 802D sl

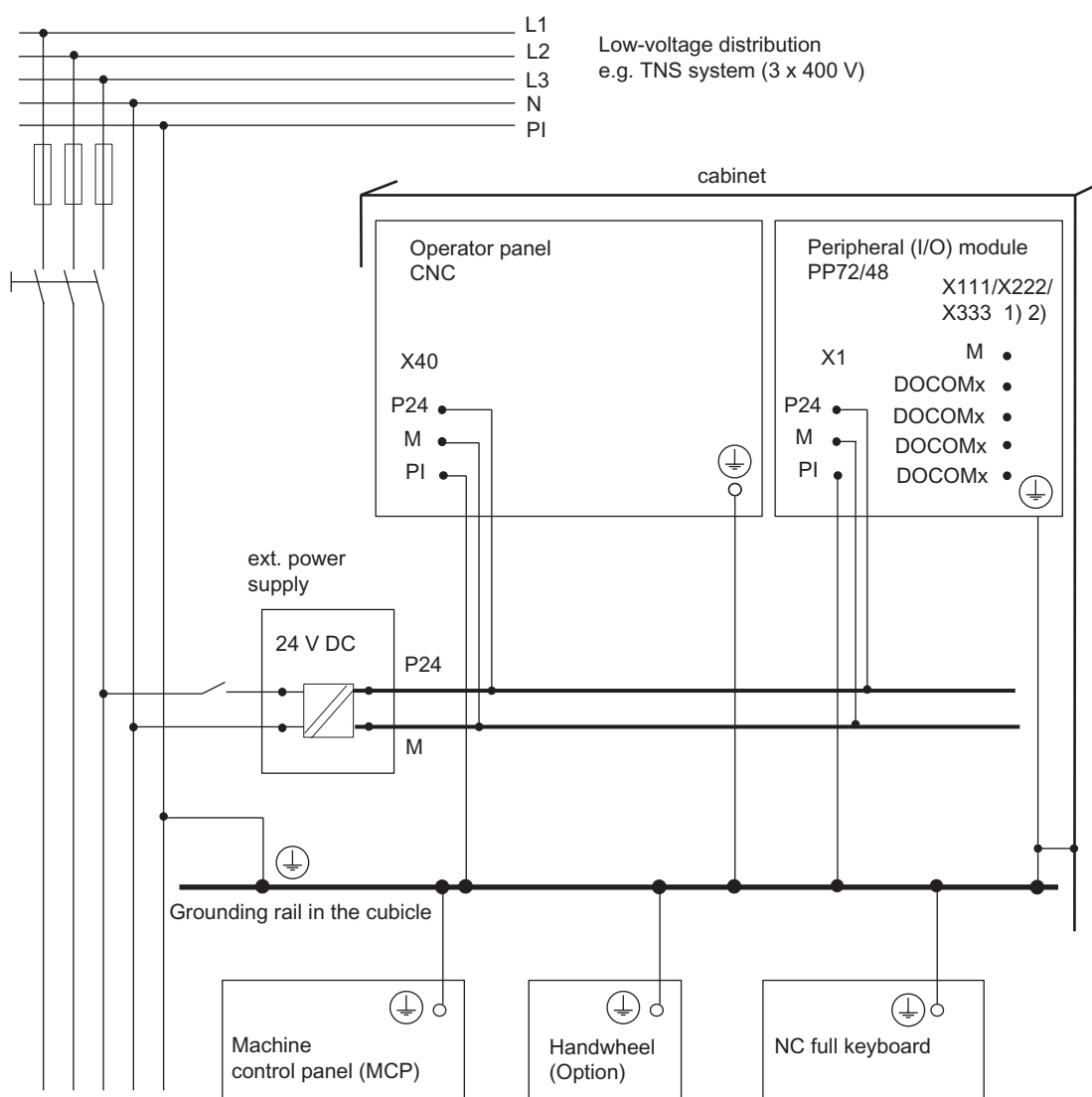

- 1) For use of an external power supply for digital inputs, see Chapter Interfaces of PP 72/48.
- 2) The load power supply is configured by the user.

Figure 5-1 Possibility of supplying the modules via a grounded infeed

5.2 Connecting the protective conductor for the individual components



Caution

The individual components shown in the Fig. "Possibility of Supplying Modules" require connection to a protective conductor. The individual components must be connected to the central grounding point.

Make always sure that a low-resistance connection is provided to the protective conductor.

Minimum cross-section of the cable to the protective conductor: 10 mm²

Whereas all remaining components are grounded via a grounding screw, the PP72/48 I/O module must be connected directly to the central grounding point via the mounting plate (installation acc. to EN 60204). If no grounding can be provided via the mounting plate, it **must** be connected to the central grounding point via an additional line (cross-section \geq 10 mm²).

5.3 Connection overview for SINUMERIK 802D sl

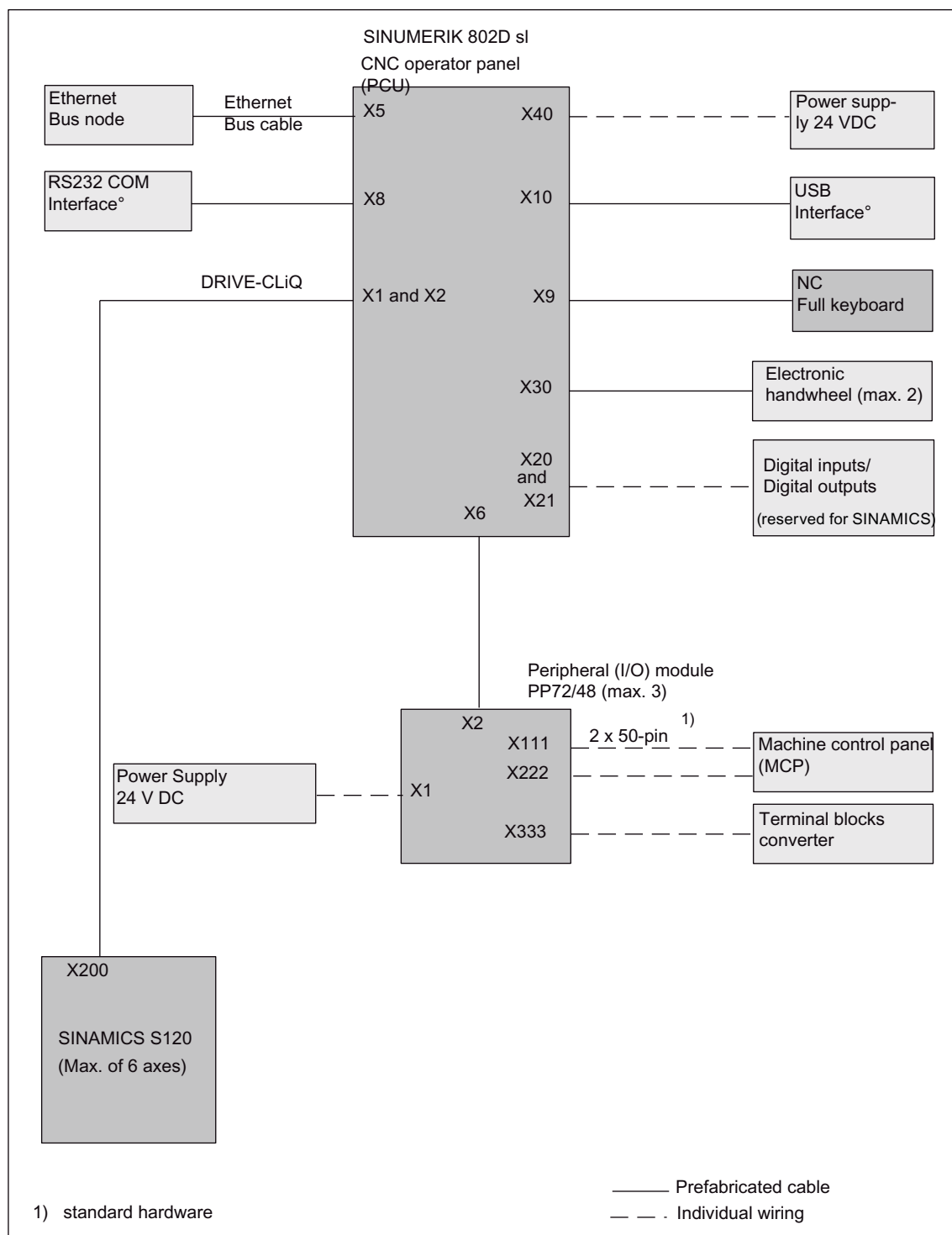

Figure 5-2 Connection overview without MCPA module

Note

Connect the lines as shown in the "Connection overview without MCPA module" illustration.
The preassembled cable sets from Siemens provide optimum interference immunity.

For information regarding the cables (cable designations, connector types, etc.), see:

References: /BU/, Catalog or /Z/, Catalog

For information regarding PROFIBUS–DP and Ethernet, see:

References: /IKPI/, Catalog

5.4 Connecting the MCPA module

The MCPA module is connected to the PCU via X110. The ribbon cable (length 0.6 m, part of the MCP 802D sl delivery) is used to connect the machine control panel MCP 802D sl. X1 is connected to X1201, and X2 to X1202.

The power supply to the MCPA module is provided via connector X1021 (PIN1 24 V; PIN10 0 V).

Note

The variable assignment of the machine control panel is described in the PLC user interface.

Notes for the Reader:

/FB/ SINUMERIK 802D sl "Description of Functions"

PLC subroutine library V01.07.00 of SINUMERIK 802D sl

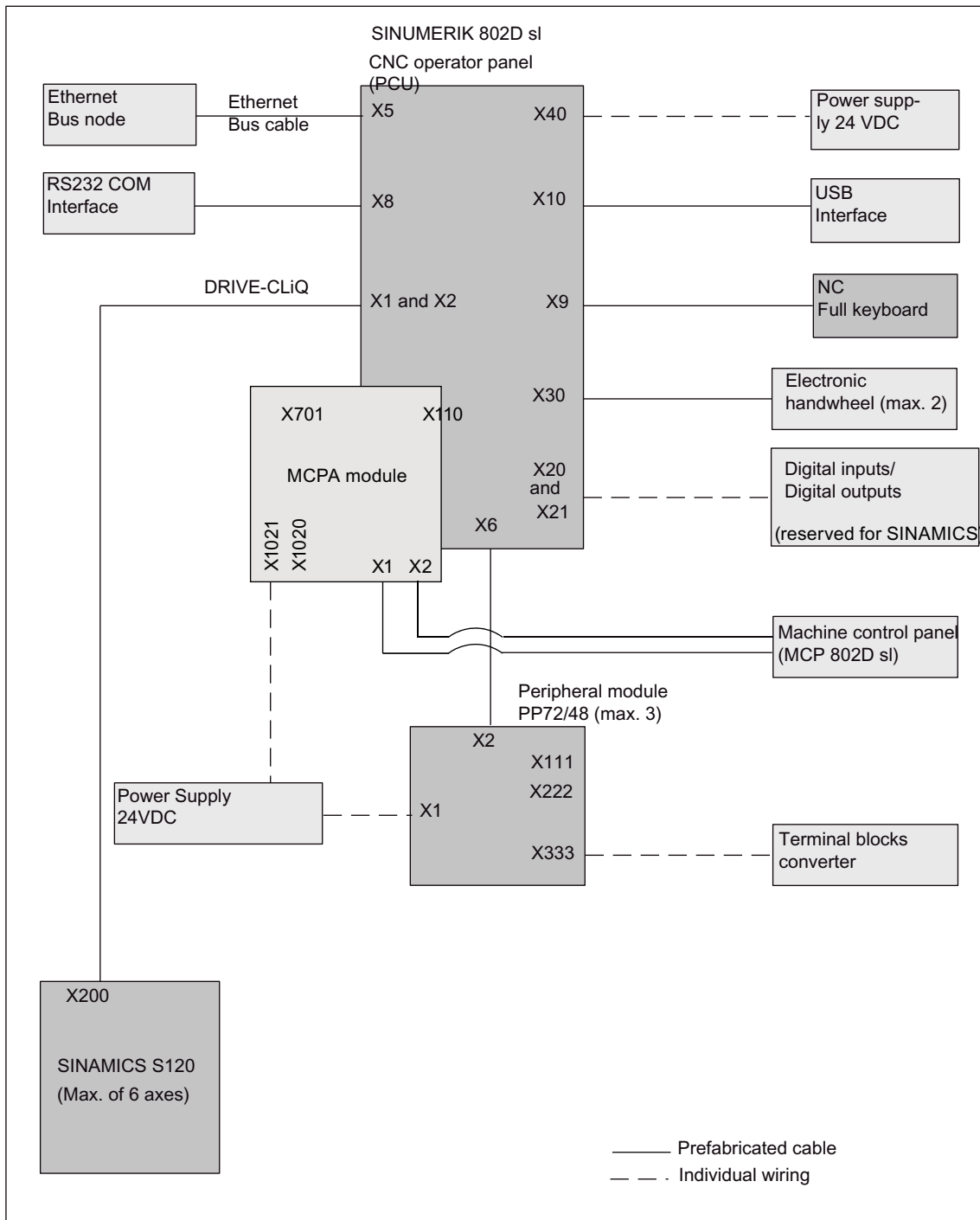

Figure 5-3 Connection overview with MCPA module

5.5 Connecting an analog spindle

The setpoint input of the analog spindle is output via the X701 interface on the MCPA module. It is possible to set the analog output to be unipolar.

The analog spindle is set up using machine data in the controller.

Connection of a directly mounted spindle actual-value encoder (TTL)

The TTL encoder requires an SMC 30 module. For configuring the X520 interface (encoder connection: TTL encoder with open-circuit monitoring), please refer to the table below.

Table 5-1 Assignment of the X520 interface

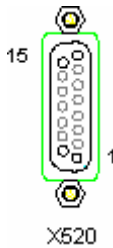
Description of the female connector	Pin	Name	Description
	1	Reserved, not assigned	-
	2	Reserved, not assigned	-
	3	Reserved, not assigned	-
	4	P_Encoder 5V/24V	Encoder power supply
	5	P_Encoder 5V/24V	Encoder power supply
	6	P_Sense	Sense input encoder power supply
	7	M_Encoder (M)	Ground for encoder power supply
	8	Reserved, not assigned	-
	9	M_Sense	Ground sense input
	10	R	Reference signal R
	11	R*	Inverted reference signal R
	12	B*	Inverted incremental signal B
	13	B	Incremental signal B
	14	A*	Inverted incremental signal A
	15	A	Incremental signal A

Caution

The encoder power supply can be parameterized to 5 V or 24 V. The encoder may be destroyed if you enter the wrong parameters.

Parameter location:

Machine data of the component (drive object) that the SMC 30 module uses to communicate with SINAMICS

Encoder configuration:

P404[0].20 for 5 V

P404[0].21 for 24 V

5.6 Connecting the high-speed digital inputs/outputs at the MCPA module

The high-speed digital inputs/outputs are connected via interfaces X1020 and X1021 of the MCPA module.

5.7 Connecting the power supply

The required 24 V DC load power supply must be connected to the following connectors:

- to screw-terminal block X40 of the CNC operator panel
- to screw-terminal block X1 of the PP72/48 I/O module

Features of the load power supply



Danger

The 24 V DC protective extra-low voltage **must** be generated as a protective extra-low voltage with safe electrical isolation (to IEC 204-1, Section 6.4, PELV) and grounded by the user (provide a PELV M signal connection to the central grounding point of the system).

Table 5-2 Electrical parameters of the load power supply for the CNC operator panel (X40) and for the PP72/48 I/O module (X1)

Parameters	Values	Conditions
Voltage range mean value	20.4...28.8 V	
Ripple	3.6 Vpp	
Non-periodic overvoltage	35 V	500 ms duration 50 s recovery time
Rated current consumption <ul style="list-style-type: none"> • CNC operator panel • PP72/48 peripheral module 	typically 1 A -	
Starting current <ul style="list-style-type: none"> • CNC operator panel • PP72/48 peripheral module 	2.6A -	
Power consumption <ul style="list-style-type: none"> • CNC operator panel • PP72/48 peripheral module 	max. 50 W max. 11 W	

Table 5-3 Pin assignment of the screw-terminal blocks X40 (on the PCU) and X1 (on the I/O module)

Terminal	Signal	Description
1	P24	24 V DC
2	G	Ground
3	PI	Protective earth

Note

Make sure that the interconnecting cable between the power supply and the load power supply connection does not exceed a maximum length of 10 m (with PP72/48 I/O module only).

Connecting the mains lines



Warning

Before connecting the modules, first disconnect the equipment from the mains!

For connecting the power supply, use flexible lines with a line cross-section of at least 1 mm².

If you only connect one line per connection, end sleeves are not absolutely necessary.

If you connect several lines per connection, you should use end sleeves.

Remove the insulation from the cable end, insert the cable end (with end sleeve) into the screw terminal connection and tighten the fastening screw.

Insert the screw terminal with the cables to connection X40 on the CNC operator panel.

Reverse polarity protection

With correct connection and the power supply turned on, the LEDs "RDY" (PCU) and "POWER" (PP72/48) are lit in green.

Note

In the event of polarity reversal, the control system will not work. However, a built-in reverse polarity protection will protect the electronics against damage.

Fuse

In case of a defect in the control system, an internally installed fuse protects the electronics from collateral damage (e.g. fire). In this case, the entire control system must be replaced.

5.8 Connecting the NC full keyboard to the CNC operator panel

The interconnecting cable for connecting the NC full keyboard to the CNC operator panel is included in the scope of supply. Connect the female connector X9 on the CNC operator panel to the PS/2 socket on the rear of the NC full keyboard.

For more information, please refer to:

Reference: /BU/, Catalog

5.9 Connecting the Ethernet interface

Connect the Ethernet connection cable to the CNC operator panel, female connector X5. Make sure that the connector locks into position when connecting.

5.10 Connecting the RS232 COM port

Insert the D-Sub female connectors into connector X8 on the CNC operator panel and into the connector on the PG/PC. Lock the connector into position using the knurled screws.

Note

Use only shielded lines twisted in pairs; the shield must be connected to the metal or metalized connector casing on the side of the control system.

The cable set offered as accessories provides maximum interference immunity.

Connection diagram

The diagram below shows the pin assignment of the interconnecting cable between the CNC operator panel and a PG/PC with 9-pin or 25-pin socket connector.

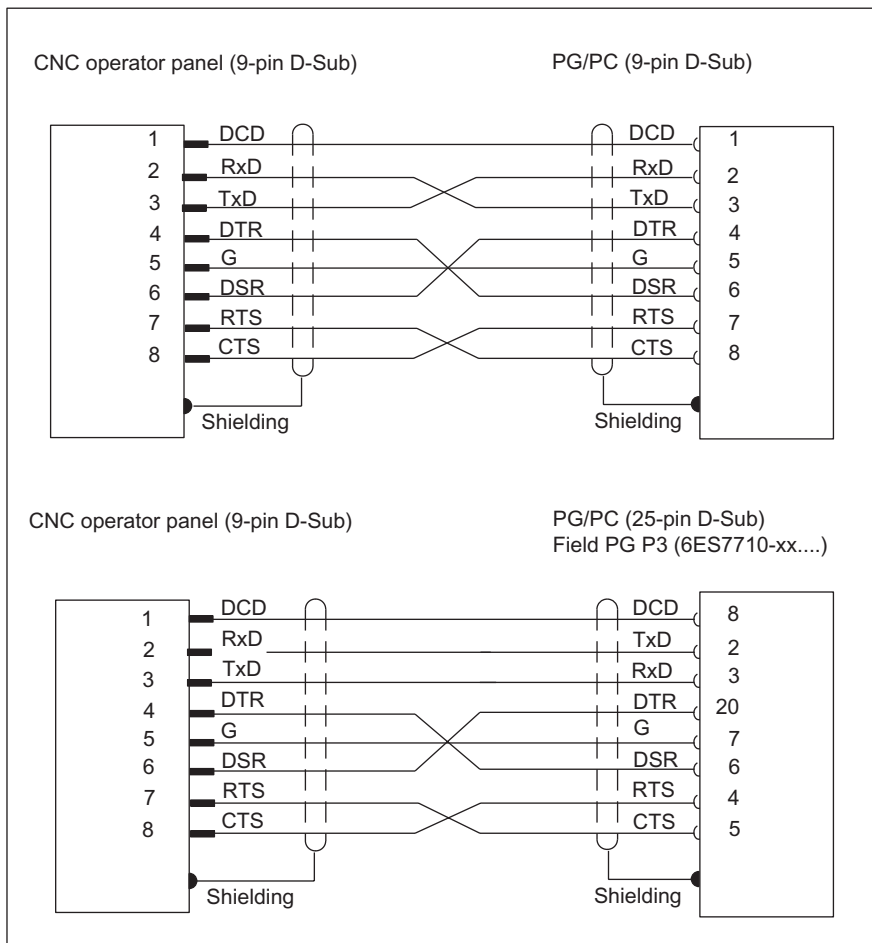

Figure 5-4 Connection diagram for interconnecting the CNC operator panel and the PG/PC

5.11 Connecting the PP72/48 I/O module

PNO design guidelines

For electrical PROFIBUS networks, observe also the PROFIBUS–DP/FMS design guidelines of the PROFIBUS user organization. They contain important measures for the cable routing and for starting up PROFIBUS networks.

Publisher: PROFIBUS–Nutzerorganisation e.V.
 Haid–und–Neu–Straße 7
 76131 Karlsruhe, Germany
 Tel: +49 721 / 9658 590
 Fax: +49 721 / 9658 589
 Internet: <http://www.profibus.com>

Guideline, order no. 2.112

Bus node

The following bus nodes can be connected via the PROFIBUS–DP interface:

- CNC operator panel (always master)
- PP72/48 I/O module (slave)

Bus connector and bus cable

The PROFIBUS cable is a two-core, stranded and shielded cable which must not be twisted, stretched or squeezed.

For more information regarding the bus connector, the bus cable and the cable length, please refer to:

References: /BU/, Catalog

Connecting the Bus Connector

To connect the bus connector, proceed as follows:

1. Plug the bus connector into the module.
2. Screw the bus connector firmly into place.
3. If the bus connector is at the start or end of the PROFIBUS–DP connection, you must connect the terminator on the connector (switch position "ON").



Figure 5-5 Bus connector terminating resistor switched on and off



Warning

A bus segment must always be terminated on both ends; otherwise, the data traffic at the bus could be disturbed.

Please make sure during startup and normal operation that power is always supplied to stations where the terminating resistor is active.

The terminator is without effect if the last station to which a bus connector is connected is dead, since the bus connector is powered from the station.

Networking example

The diagram below shows a networking example for SINUMERIK 802D sl with two PP72/48 I/O modules.

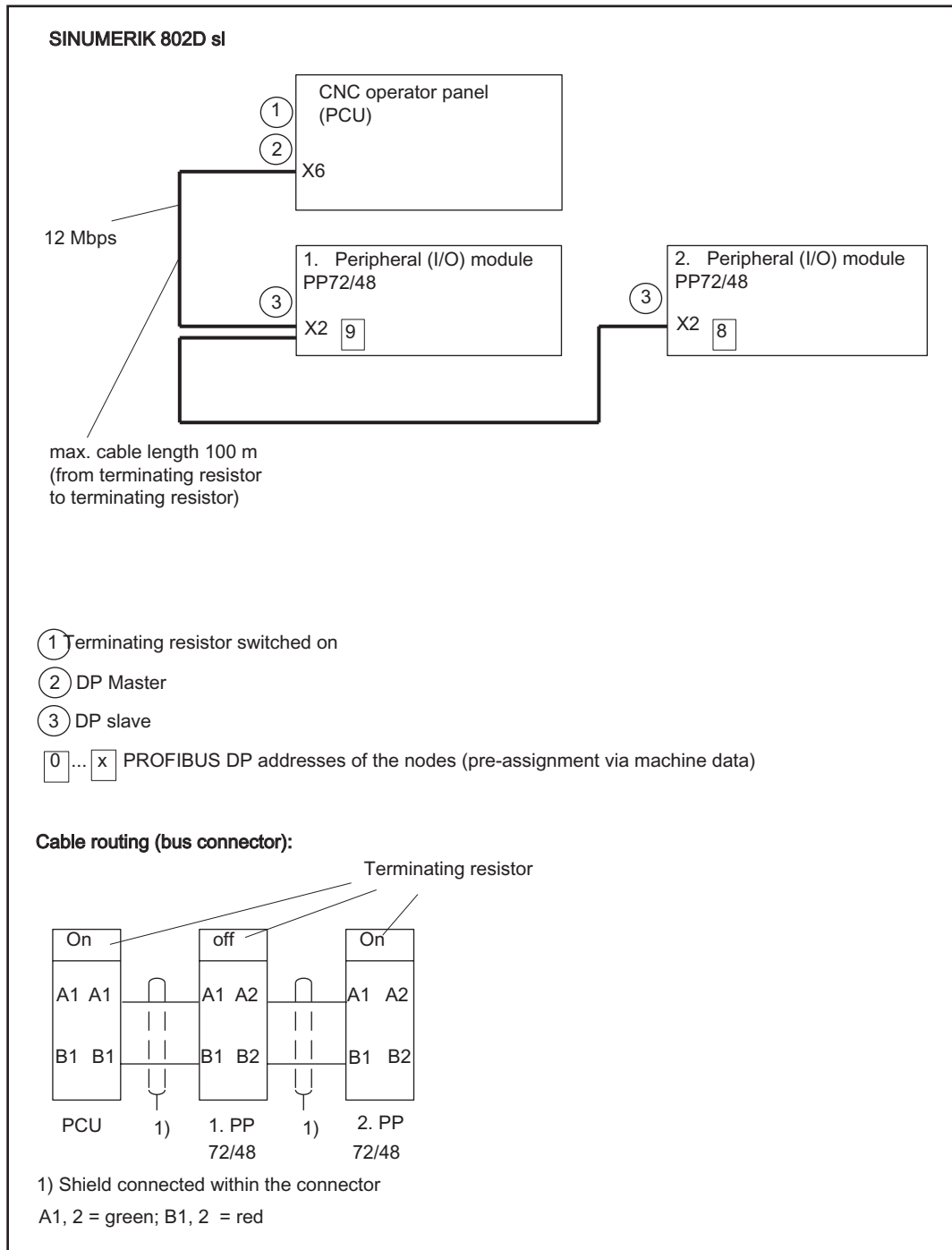

Figure 5-6 Networking example

5.12 Connecting the DP/DP coupler

Cross-control PLC data interface

The DP/DP coupler is used to link two PROFIBUS DP networks together and to transfer data from the master of one network to the master of the other network.

For SINUMERIK 802D sl, 16 bytes are available for receiving and 16 bytes are available for sending. For more information, see the "SIMATIC DP/DP coupler" manual.

Note

DP/DP coupler as of Version B2
Order number: 6ES7158-0AD01-0XA0

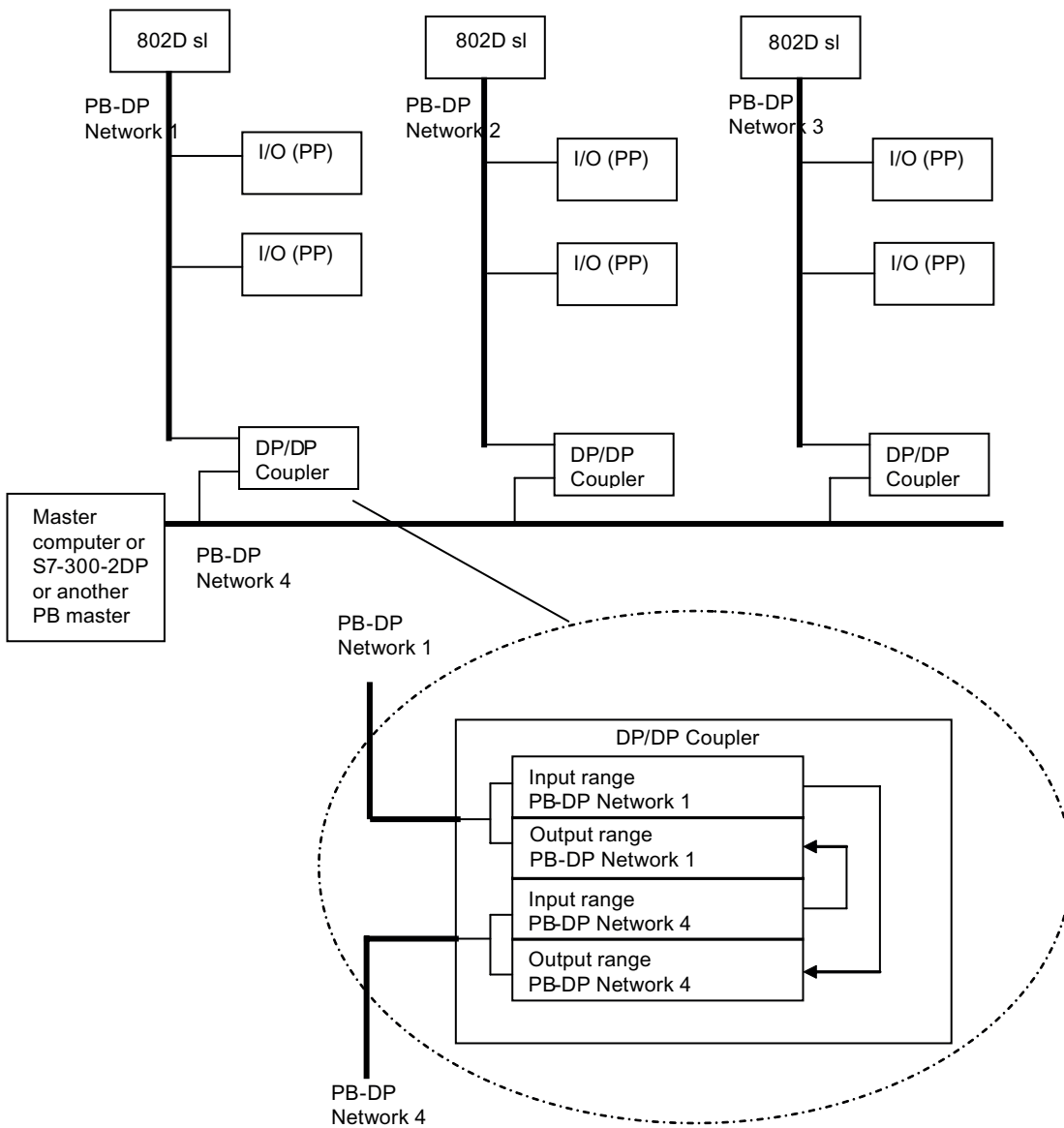

Figure 5-7 Using DP/DP coupler (example)

5.13 Connecting the SINAMICS drive to the DRIVE-CLiQ interface

Connect the female connector X1 or X2 on the CNC operator panel to the X200 female connector on the drive using the DRIVE-CLiQ signal line.

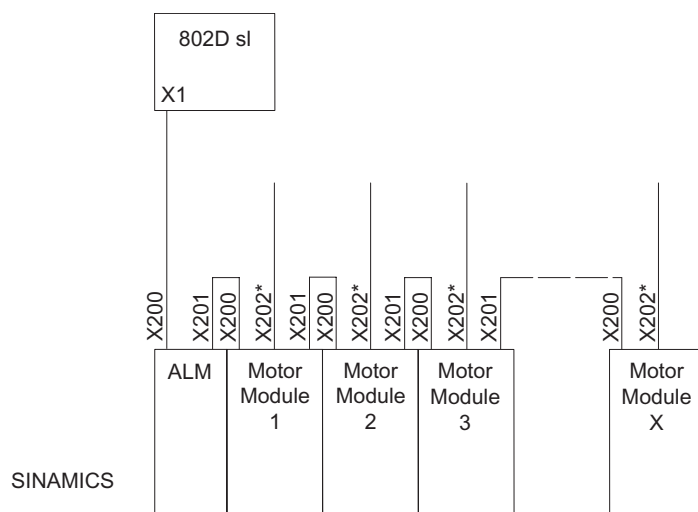

Figure 5-8 Connection with ALM (Active Line Module) and DRIVE-CLiQ

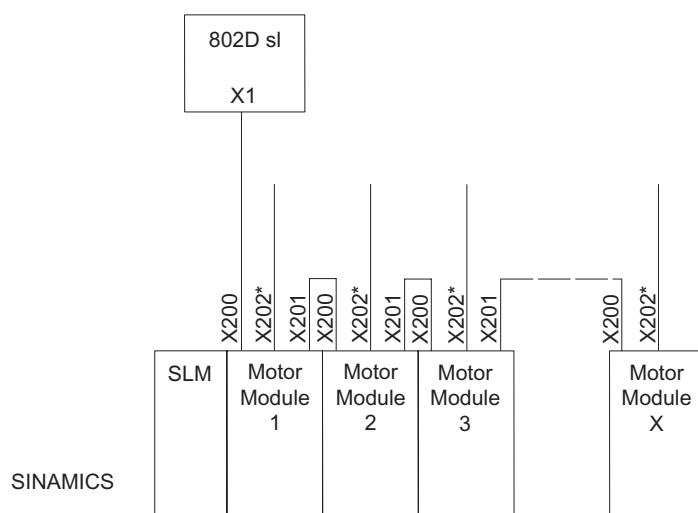

Figure 5-9 Connection with SLM (Smart Line Module) and DRIVE-CLiQ

*) Input from the measuring system

Note

The connection with SLM and DRIVE-CLiQ is made like the connection with ALM and DRIVE-CLiQ.

With SMI motors (integrated measuring system interface), the connection is provided from the motor directly to X202 via the DRIVE-CLiQ line. For direct measuring systems, connect the measuring system via a SMCxx module (xx depends on the type of the measuring system you are using: e.g. SMC20 with incremental encoder or SMC30 with TTL encoder).

5.14 Connecting the digital inputs/outputs to the PCU

Connection cables

To connect the digital inputs and outputs, you should use flexible lines with a cross-section of at least 0.5 mm².

If you only connect one line per connection, end sleeves are not absolutely necessary.

If you connect two lines per connection, lines with a cross-section between 0.25 and 0.75 mm² with end sleeve must be used.

Fasten the lines to the supplied screw terminals and insert the terminals to the connectors X20 and X21 on the CNC operator panel.

Note

To ensure optimum interference immunity when connecting probes or BEROs, shielded lines must be used.

The max. line length is 30 m.

5.15 Connecting the digital inputs/digital outputs to the PP72/48 I/O module

You can use the I/O interfaces X111, X222, X333 as digital inputs or digital outputs. To this end, fasten the insulation displacement connector to the ribbon cable and route it from the I/O module to the terminal strip converter. The individual wiring can be performed on the terminal strip converters.

Remove the insulation from the cable end, insert the cable end (with end sleeve) into the screw terminal connection and tighten the fastening screw.

5.16 Connecting the machine control panel to the PP72/48 I/O module

Connect the machine control panel (X1201 and X1202) to the PP72/48 I/O module (e.g. X111 and X222) using two ribbon cables.

For more information, please refer to:

References: /BU/, Catalog

Note

You can find more information regarding the machine control panel and the pin assignment of the connectors X1201 and X1202 in Chapter "Interfaces of MCPA module".

5.17 Connecting shielded cables via the shield connection (PCU)

The shield of shielded signal lines must be connected to ground. The connection to ground is achieved by connecting the shield connection directly to the housing.

Shield connection

EMC shield clips (2 units) are used as the shield connection and are part of the scope of delivery of the CNC operator panel.

Mounting the shield connection

1. Remove the isolation from the shield according to the EMC shield clip.
2. Place the shield on the housing in the appropriate place (see Figure below).
3. Screw the EMC shield clips onto the housing.

Ensure firm fit of the cable on the housing.

4. For mechanical strain relief of the lines and cables, you can use the cable clamp or the EMC shield clips (see Figure below).

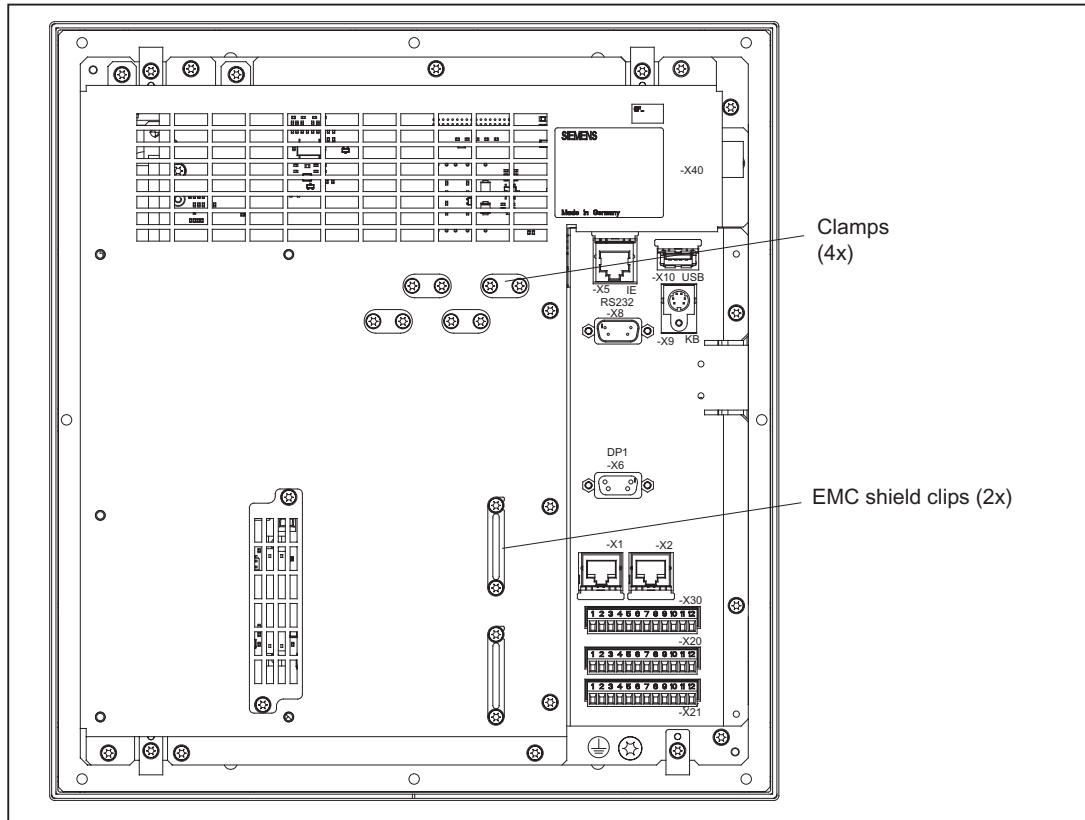

Figure 5-10 Connecting and securing shielded lines via the shield connection

Operation (hardware)

6.1 Operator control and display elements

Operator control elements

The defined functions are called up via the horizontal and vertical softkeys. For a description, please refer to this manual:

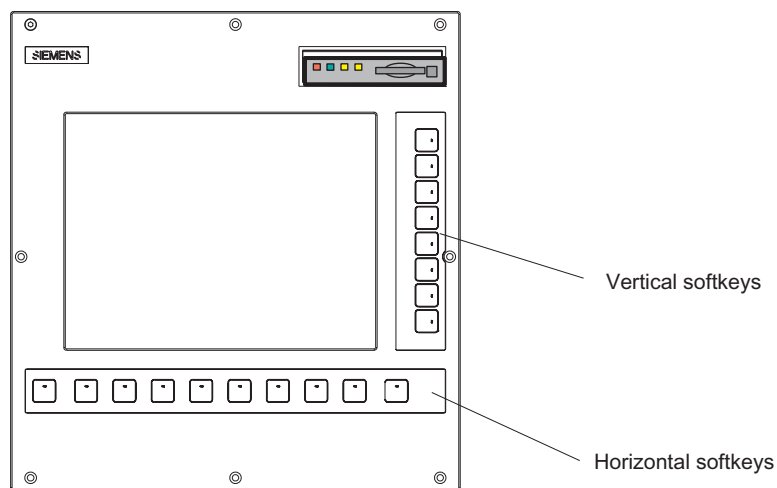
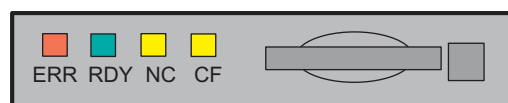

Figure 6-1 CNC operator panel

6.2 Status and error displays

Display of the LEDs on the operator panel CNC (PCU)

The following LEDs are installed on the operator panel CNC.



The individual LEDs and their functions are described in the table below.

Table 6-1 Status and error displays

LED	Meaning
ERR (red)	Serious error, remedy through power OFF/ON
RDY (green)	Data Set Ready
NC (yellow)	Signoflife monitoring
CF (yellow)	Reading from/writing to CF card

Note for the reader

You can find information on error description in /DG/, SINUMERIK 802D sl, Diagnostics Manual

LED displays on the PP 72/48 I/O module

The following LEDs are installed on the I/O module:

Table 6-2 Status displays

LED	Meaning
POWER (green)	Power supply of the electronic equipment ready for operation
READY (red)	I/O module ready for operation; but no cyclic data exchange with DP Master is performed
EXCHANGE (green)	I/O module ready for operation; cyclic data exchange with DP Master is performed
OVTEMP (red)	Overtemperature indication

Commissioning (General)

7.1 Initial commissioning (IBN)

Commissioning requirements

- You will need the following:
 - SINUMERIK 802D sl User Documentation
 - SINUMERIK 802D sl Description of Functions
 - Lists manual for the SINUMERIK 802D sl
 - A PC for commissioning and data backup
 - Tools installed from the Toolbox CD:
 - RCS802 Commissioning and Diagnostic Tool
 - PLC802 Programming Tool
 - 802D sl Configuration Data
 - PLC Library
 - STARTER (for optimizing the drive)
 - Adobe Acrobat Reader
- The mechanical and electrical installation of the system must be completed.

Commissioning sequence

To commission the SINUMERIK 802D sl, proceed as follows:

1. Check that the PCU boots.
2. Load language files
3. Load technology
4. Set the general machine data.
5. Set the PROFIBUS addresses
6. PLC commissioning
7. Start up the drive.
8. Set the axis/spindle-specific machine data.
 - Match the encoder to the axis / spindle.
 - Match the setpoint to the axis / spindle.

- 9. Perform a dry run for the axes and for the spindle.
- 10. Drive Optimization
- 11. Complete the commissioning; perform a data backup.

7.2 Access levels

Protection levels

The SINUMERIK 802D sl provides a concept of protection levels for enabling data areas. The various access authorizations control the protection levels 0 to 7 whereby **0** is the highest and **7** the lowest level.

The control system is delivered with default passwords for protection level 1 to 3.

Table 7-1 Access level concept

Protection level	Locked by	range
0		Siemens, reserved
1	Password: SUNRISE (default)	Expert mode
2	Password: EVENING (default)	Machine manufacturer
3	Password: CUSTOMER (default)	Authorized operator, setter
4 to 7	No password/deleted password and user interface from PLC → NCK	Authorized operator, setter or appropriate graduations as desired

In the menus listed below the input and modification of data depends on the protection level set:

- Tool offsets
- Work offsets
- Setting data
- RS232 settings
- Program creation / program correction

The protection levels can be set for these function areas using the display machine data (USER_CLASS...)

Protection levels 1 ... 3

The protection levels 1 to 3 require a password. Passwords can be changed after activation. If they are no longer recognized, a reinitialization must be carried out (power up with default machine data). This will reset all passwords to their defaults according to the software release you have acquired.

The password remains set until it is reset by selecting the **<Delete password>** softkey. **POWER ON** will **not** reset the password.

Protection levels 4 ... 7

Protection level 7 is set automatically if no password is set and no protection level interface signal is set. The protection levels 4 to 7 can be set from the PLC user program even without a password by setting the bits in the user interface.

Note

Setting of the access levels is described in the Programming and Operating Manual.

7.3 RCS tool

With the RCS tool (Remote Control System), you are provided with an Explorer tool for your PC/PG to assist you in your daily work with SINUMERIK 802D sl.

The connection between the control system and the PC/PG can be provided either via an RS232 cable or a local network cable (optional).

Notice

You will obtain the full functionality of the RCS tool only after importing the license key RCS 802.

With this key, the connection to the control system can be established via a local network (only for SINUMERIK 802D sl pro) and the remote operating function and other functions can be used.

Without a license key, only local directories (on the PC/PG) are released for accessing via the control system.

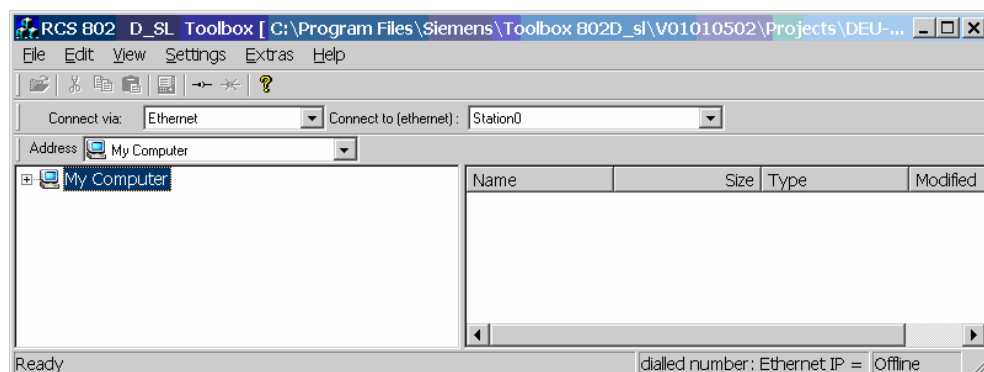

Figure 7-1 Explorer window of the RCS tool

After starting, you are in offline mode. This means that you can manage files on your PC only. In the online mode, the **Control 802** directory is also available for data exchange with the control system. In addition, a remote control function is provided for process monitoring.

Note

The RCS tool provides a detailed online help function. For further details e.g. establishing a connection, project management etc., please refer to this help menu.

7.4 STARTER commissioning tool

To launch the STARTER program, click the STARTER icon or choose **Start > Programs > STARTER > STARTER** from the Windows Start menu.

Note

The screen forms of the STARTER tool, version V3.2, are shown in the following. If your particular version deviates from the version used here, your screen forms may deviate slightly from those shown here.

7.4.1 The STARTER user interface

You can use STARTER to create the sample project. To perform the individual configurations, use the user interface areas listed below:

- Project navigator: This area displays the elements and objects you will insert into the project.
- Working area: Use this area to perform your task for creating the project:
 - When you are configuring the drive, this area contains the Wizards that help you configure the drive objects.
 - If you configure, for example, the parameters for the speed setpoint filter.
 - When you call up the expert list, the system displays a list of all the parameters that you can view or change.
- Detailed view: This area provides detailed information, for example, on faults and warnings.

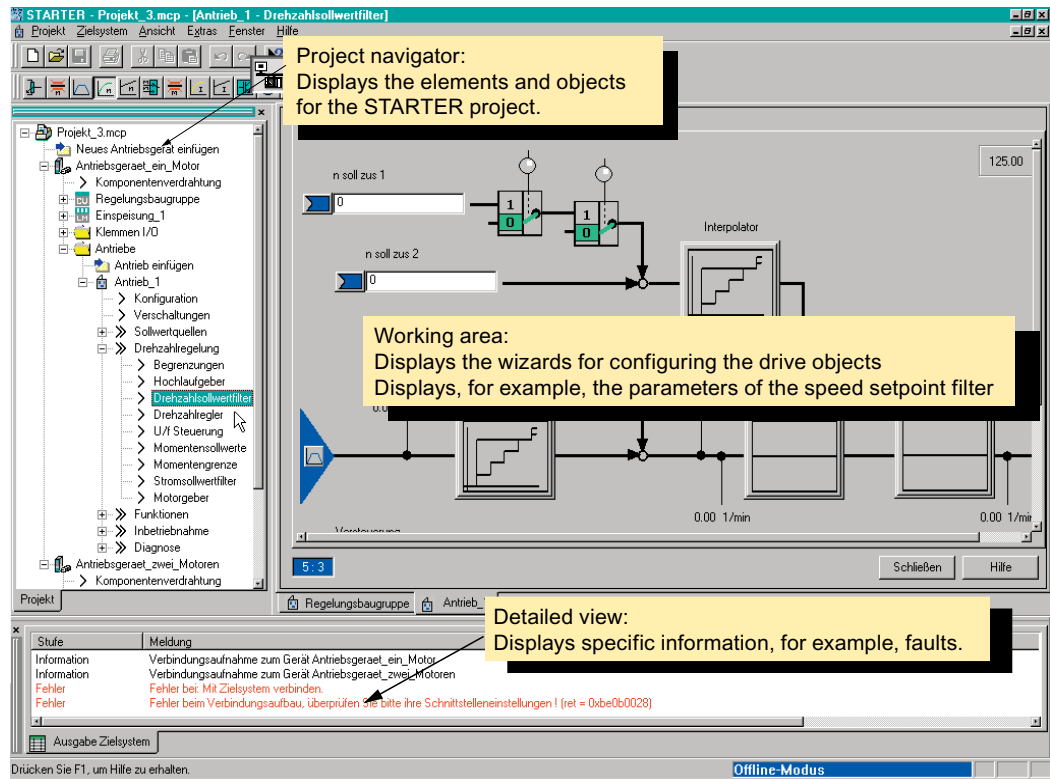

Figure 7-2 The different areas of the STARTER user interface

7.4.2 Operating philosophy of the STARTER commissioning tool for SINAMICS S120

When creating a drive unit for a SINAMICS S120 system, the following operating philosophy is assumed:

The tool is used to process objects (e.g. **infeed**). The object name is user defined.

A drive unit in the terms of the STARTER commissioning tool is always a control unit and the appropriate drives.

With a controlled infeed, the Active Line Module is configured in STARTER. An uncontrolled infeed is not represented in STARTER.

The appropriate drive consists, for example, of a Motor Module (power section) and of a motor with encoder.

The following figure shows the project navigator in STARTER. A project with the name **802D sl** and a drive unit with the name **SINAMICS_IN_802D** have been configured for 6 drives.

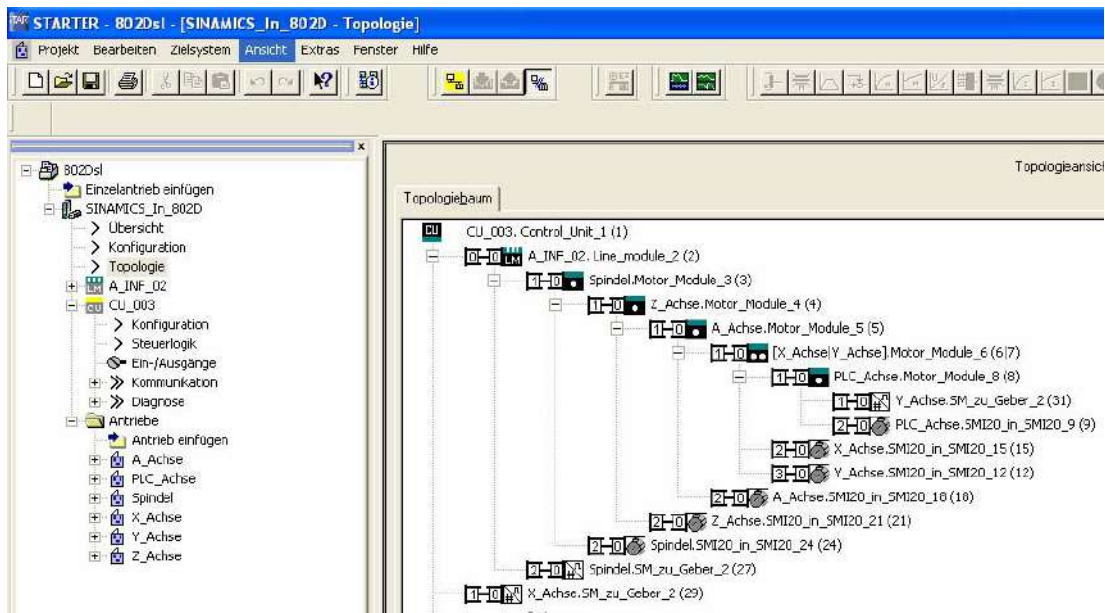

Figure 7-3 SINAMICS_IN_802D

7.4.3 Diagnosis via STARTER

Description

The diagnostic functions support commissioning and service personnel during commissioning, troubleshooting, diagnostics and service activities.

General information

Prerequisites: STARTER is in the online mode.

The following diagnostic functions are available in STARTER:

- PROFIBUS diagnostic buffer

The message output window shows the states of the control/status words, parameters and drive enable signals for the selected drive/device.
- Fault/alarm display in the alarms output window

The faults and alarms for one or more drives/devices can be displayed. The fault/alarm description is called up by selecting "Help -> Context" or by pressing the SHIFT + F1 keys.
- Diagnostics overview

An overview table is displayed containing all the drives available in the project.

 - Device: the available devices and drives are displayed with names; the device status is output in the "device diagnostics" window.

- Operating state: It is not possible to control the current status (e.g. OFFLINE, ONLINE, IBN, STOP) on SINUMERIK 802D sl using the operating modes selector switch.
- Specifying signals with the ramp-function generator
- Signal recording with the trace function
- Analyzing the control response with the measuring function

7.4.3.1 Function generator

Description

The function generator can be used, for example, to perform the following tasks:

- for measuring and optimizing closed-loop control circuits;
- for comparing the dynamic properties of coupled drives;
- for specifying a straightforward traversing profile without traversing program.

With the function generator as the setpoint source, it can be used to generate various signal forms.

The output signal can be supplied to the closed-loop control circuit via the BICO circuit in the "Connector output" mode.

In the Servo mode, this setpoint can additionally be supplied into the control structure in accordance with the currently selected mode of the function generator, for example, as a current setpoint, disturbing torque or speed setpoint. Any influence of overlaid closed-loop control circuits is suppressed automatically.

Parameterizing and operating the function generator

The function generator is parameterized and operated via the STARTER parameterization and commissioning tool.

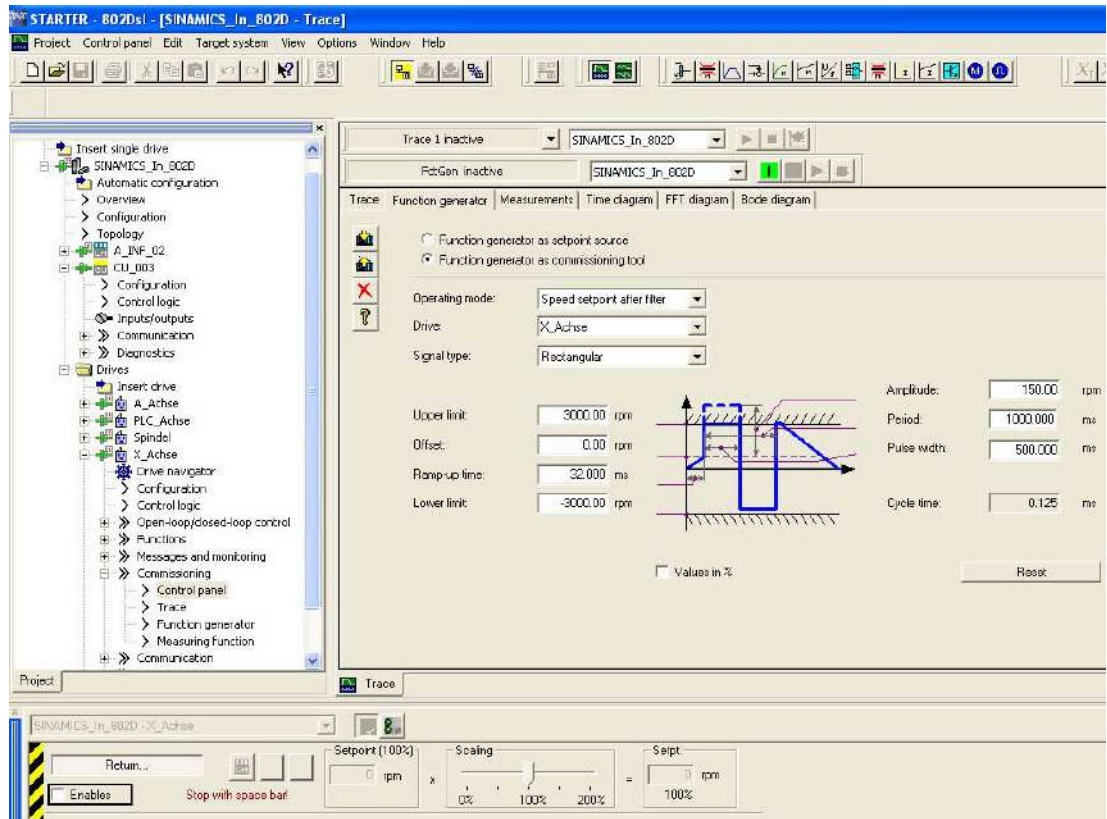

Figure 7-4 Figure 1-4 "Function generator" start screen

Note

Please refer to the online help for more information about parameterizing and using the measuring sockets.

Features

- The following parameterizable signal forms can be set:
 - Rectangle
 - Staircase
 - Triangle
 - PRBS (pseudo random binary signal, white noise)
 - Sinusoidal
- An offset is possible for each signal. The power-up to the offset can be parameterized. The signal generation starts after the power-up for the offset.
- Restriction of the output signal to the minimum and maximum value can be set.
- Operating modes of the function generator for servo and vector only

- Connector output
- Operating modes of the function generator for servo only
 - Current setpoint downstream of the filter (current setpoint filter)
 - Disturbing torque (downstream of the current setpoint filter)
 - Speed setpoint downstream of the filter (speed setpoint filter)
 - Current setpoint upstream of the filter (current setpoint filter)
 - Speed setpoint upstream of the filter (speed setpoint filter)

Switching points of the function generator

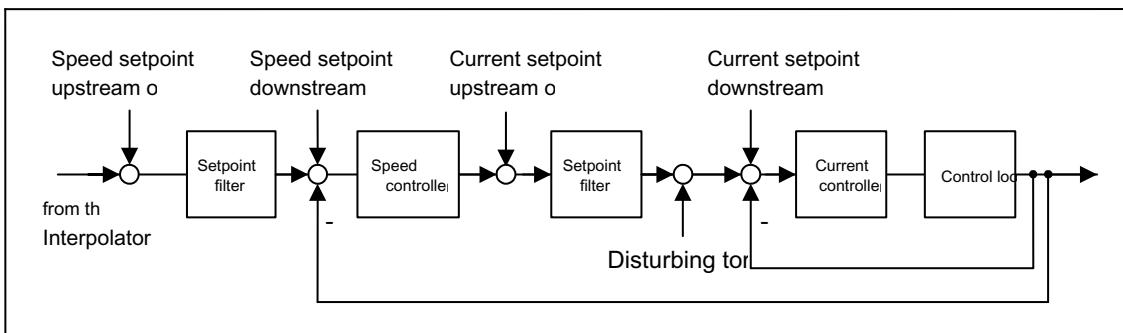

Figure 7-5 Switching points of the function generator

Further signal forms

Further signal forms can be produced by parameterization.

Example:

The "triangular" signal form can be parameterized with "upper limitation" to produce a triangle with no peak.

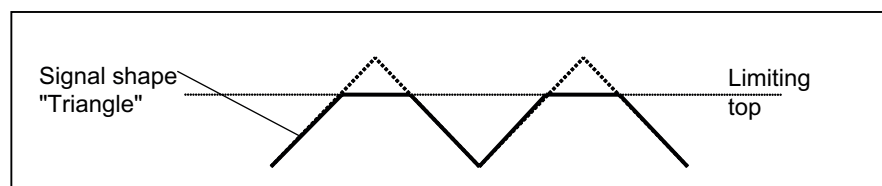

Figure 7-6 "Triangular" signal without peak

Starting/stopping the function generator



Caution

With the corresponding ramp-function generator parameter settings (e.g. offset), the motor can "drift" and travel to its end stop.

The motion of the drive is not monitored with the function generator activated.

To start the function generator, proceed as follows:

1. Provide for the prerequisites for starting the function generator.
 - Activate the control panel.
Drives → Drive_x → Commissioning → Control panel
 - Turn on the drive.
Control panel → Issue enables → Switch on
2. Select operating mode
e.g. speed setpoint downstream of the filter.
3. Select the drive (as the control panel).
4. Set the signal form,
e.g. rectangle
5. Load the settings to the target system ("Download parameters" pushbutton)
6. Start the ramp-function generator ("Start FctGen" pushbutton)

To stop the function generator, proceed as follows:

"Stop FctGen" pushbutton

Configuration



The "function generator" parameter screen is selected via this icon in the toolbar of the STARTER commissioning tool:

7.4.3.2 Trace function

Description

The trace function can be used to acquire measuring values over a specified period, depending on the trigger conditions.

Parameterizing and operating the trace function

The trace function is parameterized and operated via the STARTER parameterization and commissioning tool.

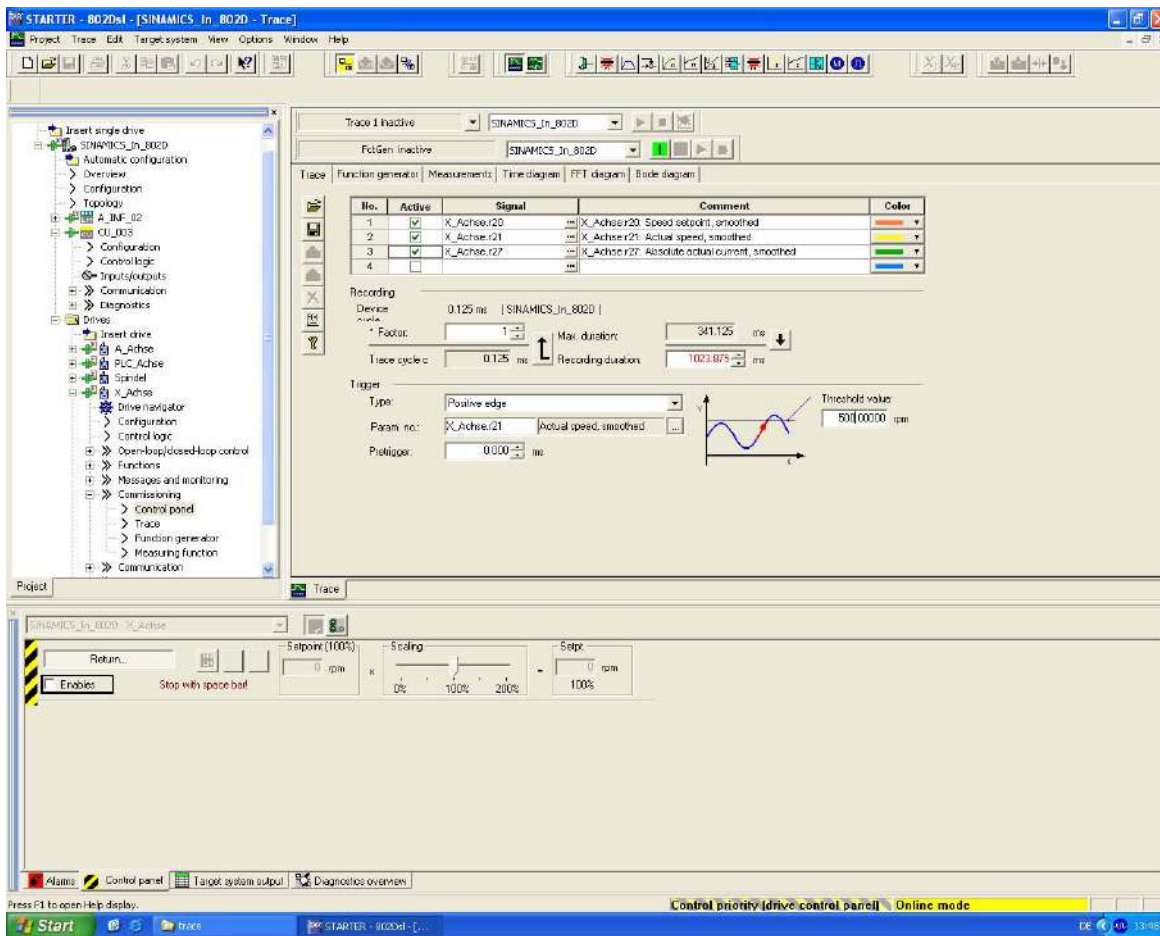

Figure 7-7 Figure 1-8 "Trace function" start screen

Note

Please refer to the online help for more information about parameterizing and using the measuring sockets.

Features

- Four recording channels per recorder
- Two independent trace recorders per Control Unit
- Triggering
 - Without triggering (recording immediately after start)
 - Triggering on signal with edge or on level
 - Trigger delay and pretrigger possible

- STARTER parameterization and commissioning tool
 - Automatic or adjustable scaling of display axes
 - Signal measurement via cursor
- Settable trace cycle: integers of the base sample time

Configuration



The "trace function" parameter screen is selected via this icon in the toolbar of the STARTER commissioning tool.

Initial start-up

8.1 Turning on and booting the control system

Procedure

- Check the system visually for:
 - correct mechanical design and check that all electrical connections are performed correctly.
 - Supply voltage
 - connection of shielding and grounding.
- Connect the control system (booting in the normal mode)

Bootling in the normal mode

When the control system is turned on, the boot sequence is displayed on the control system with all its individual phases. Once the start screen of the user interface has appeared, the booting sequence is completed.

Bootling in the start-up mode

After POWER ON and once the operating system has been started, the words "SINUMERIK Solution line" are displayed filling the whole screen. Once these words disappear, press the **SELECT** key.

The **START UP MENU** is displayed. Use the arrow key to select an appropriate power-up/start-up mode and press **<ENTER>** to confirm.

If there is no password set, the following modes are available:

- **Normal startup**

If this option is chosen, the control system will boot with the last machine data set and the previously loaded programs.
- **Reload saved user data**

The user data (machine data, programs, etc.) that was backed up to the flash memory are accepted as the current data and the boot up is carried out.
- **software update**

In this case, the control system will not boot at all. The software can only be updated if a CF card with a software update is inserted in the slot for the CF card.

If there is a password set, the following modes are available:

- **Normal startup**
- **Reload saved user data**
- **Startup with default data** (is only displayed if protection level 1 or 2 is set)
If this option is chosen, the control system will boot with default machine data.
- **PLC stop**
Select PLC Stop while the control system is booting if PLC Stop can not be triggered via the user interface any more.
- **PLC overall reset / default PLC program**
All PLC variables are reset, a NOP (no operation) program is loaded.
- **HMI startup with default data**
The HMI will power up with default machine data.
- **Remove drive data**
The drive machine data is reset and the default setting is loaded.
- **Remove drive data/default data**
The drive machine data is reset and the default data is loaded.
- **software update**
In this case, the control system will not boot at all. The software can only be updated if a CF card with a software update is inserted in the slot for the CF card.

8.2 Language setting and file management

The default setting of the controller for both the foreground and background language is English. You can change the languages by loading new language files from the toolbox using the RCS802 tool.

8.2.1 Creating and Editing Projects

Prerequisites

The RCS802 tool and the toolbox are installed on the PC/PG.

Creating a project

- Start RCS802 on the PC.
- Select the **Toolbox > Controller** menu item from the **Settings** menu bar and select the 802D sl control.
- Select the Toolbox version under **Settings > Toolbox > Select Version and Project** and click on **Project (1)**.

- In the menu display (2), click on **New**, the system then opens the **Create new project** window (3).
- Enter a name for the new project and select the foreground and background language. Confirm the entry **Create**. The system creates the new project and displays it in the project overview (4).

Note

To activate the project selected, click on **OK** in the project overview(4).

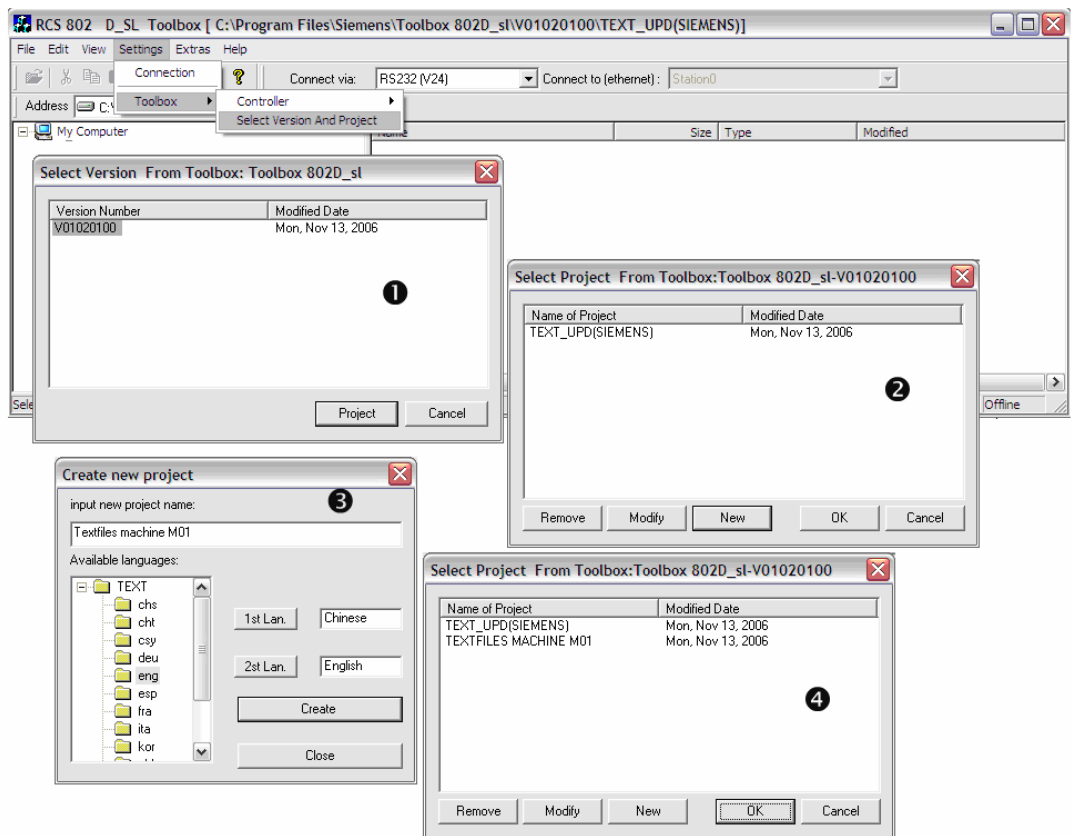

Figure 8-1 Creating a project

Editing a project

- Start RCS802 on the PC.
- Select the Toolbox version under **Settings > Toolbox > Select Version and Project** and click on **Project** (1).
- Select the project to be edited in the project overview (4) and click on **Modify**.

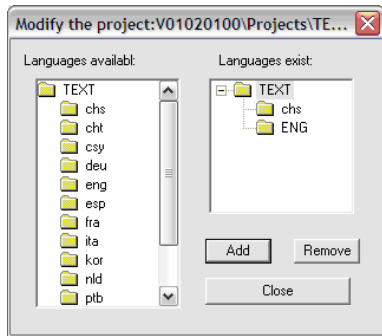

Figure 8-2 Editing a project

- In the subsequent menu display, you can add languages to or remove languages from the project.

8.2.2 Help, language and alarm files

To create the help system, select the menu item **Tools > Toolbox Manager > Generate Help System** from the RCS802 menu bar. Here you can also create a new language or new text files. You can either edit or delete (1) existing text files. By clicking on **Generate Helptext** (2), you can generate the help system to be generated subsequently.

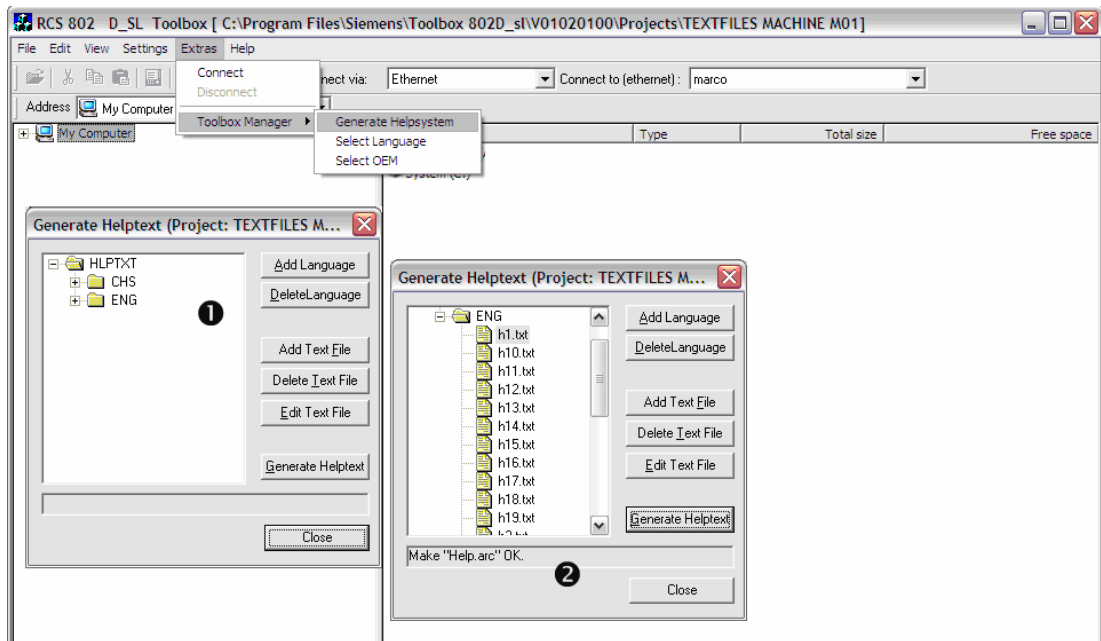

Figure 8-3 Generating text files for the online help

To transfer the help system to the control system, there must be a connection between PC/PG and the control system. After the generation, you can make the transfer to the control system by clicking on **Transfer to 802**.

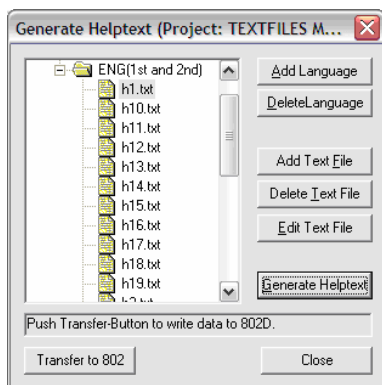

Figure 8-4 Transferring data to the control system

You can select and transfer foreground and background languages under **Tools > Toolbox Manager > Select Language**.

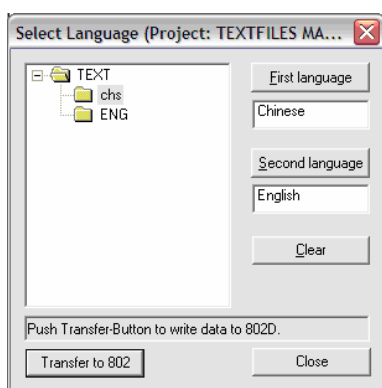

Figure 8-5 Transferring the language

Texts for PLC user alarms (alcu.txt), user cycles (alsc.txt) and NC user alarms (alz.txt) can be created using the **Tools > Toolbox Manager > Select OEM** menu. User stands here for both end user and machine manufacturer.

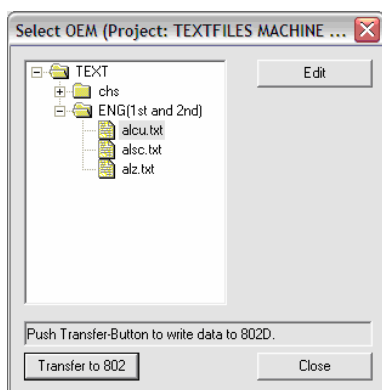

Figure 8-6 Changing OEM files

8.3 Setting the technology

Note

The SINUMERIK 802D sl is delivered with default machine data. In the next step, the appropriate setup file **must** be loaded from the toolbox into the control system.

The following technology can be configured using setup files:

- Lathing
- Milling
- external cylindrical grinding and
- Nibbling

From the installed toolbox, the setup file relevant for the technology is to be used in conjunction with the control system variant (value, plus, pro).

The setup file must be loaded during the commissioning after booting of the control system, but prior to the general configuration.

Notice

The trafo_Mx.ini describes memory-standardizing machine data. The data must be saved by creating and rereading a series start-up file.

Note

Please always observe the readme file supplied with the "Toolbox". It provides up-to-date information.

Lathing configuration

- setup_T.arc
contains the complete setup for the lathing technology, including standard cycles.
- setTra_T.arc
contains the complete setup for the lathing technology, including standard cycles with a second spindle for the options TRANSMIT, TRACYL and the use of milling cycles.
Note: Only load one of the two setup files.
- trafo_T.ini
Text file - only for the lathing technology. These settings are supplemented by the lathing technology with machine data for the second spindle and for the options TRANSMIT/TRACYL.
Note: If you use milling cycles, load the cycles.spf file into the control system.

- trafo_Mx.ini
Text file for milling applications on the lathe. These settings are supplemented by the lathing technology with machine data for the second spindle and for the option TRACYL.
 - trafo_MA.ini: for rotary axis A
 - trafo_MB.ini: for rotary axis B
 - trafo_MC.ini: for rotary axis C
- setISO_T.arc
Binary file for switching from SIEMENS mode to ISO mode lathing (B code) with simulation axes and spindle.
- isoTra_T.arc
Binary file for switching from SIEMENS mode to ISO mode lathing (B code) with second spindle.
- ISO_A_T.ini
Text file for switching from ISO mode B code to ISO mode A code
- ISO_C_T.ini
Text file for switching from ISO mode B code to ISO mode C code
- ISO_B_T.ini
Text file to switch back from ISO mode A code or C code to B code
- turnG22.ini
Text file to switch on the function "STORED STROKE CHECK FUNCTION".

Milling configuration:

- setup_M.arc
contains the complete setup for the milling technology, including standard cycles.
- setISO_M.arc
Binary file for switching from SIEMENS mode to ISO mode milling with simulation axes and spindle.
- ISOG70_M.ini (to use G70/G71 for INCH/METRIC)
Text file to use the function G70/G71 for INCH/METRIC switchover also in the ISO mode milling.
- millG22.ini
Text file to switch on the function "STORED STROKE CHECK FUNCTION".



External cylindrical grinding configuration:

- setup_G_C.arc
contains the complete setup for the external cylindrical grinding technology with Cartesian X-Z axes, including standard cycles.
- setup_G_C_inc.arc
contains the complete setup for the external cylindrical grinding technology with Cartesian X-Z axes (inclined axis with fixed angle), including standard cycles.

Nibbling configuration:

- setup_N.arc
contains the complete setup for the nibbling technology with mechanically coupled die.
- setup_N_MC.arc
contains the complete setup for the nibbling technology with die coupled via servo axis.

Sequence of operations

- Establishing a connection between PC and the control system (CNC operating panel)
- Turn on the control system and wait until the control system has completed its booting sequence without errors. In the "System" operating area, set the password for protection level 2 or higher.
- Start RCS802 on the PC and establish a connection between the PC and the control system using the  button.
- Use Copy/Paste to copy the icon of the setup file into the "Data" folder of drive A of your 802D sl.
If the toolbox has been installed in the default directory, the setup files are to be found, e.g. at
C:\Programs\Siemens\Toolbox
802Ds\V030005\V01xyyyz\TECHNO\MILLING\CONFIG_xx\

- The control system boots automatically during the transmission several times.
- The SINUMERIK 802D sl is now preset to the required technology.

8.4 Input of the machine data

Overview

The most important machine data of the individual subareas are listed here to assist you. The detailed description of the machine data and interface signals is given in the Parameter Manual with cross-references to the section on function description.

Note

The machine data is preset by loading the technology files in such a manner that a change to the values is only required in exceptional cases.

Entering the machine data (MD)

Before you can enter the machine data, the password for protection level 2 must be set.

Use the relevant softkey to select the following machine data areas and to change the machine data if necessary:

- General machine data MD 10000 ... 19999

- Channel machine data MD 20000 ... 29999
- Axis machine data MD 30000 ... 39999
- Display machine data MD 1 ... 999
- Setting data
 - General setting data
 - Channel-specific setting data
 - Axis-specific setting data
- Drive machine data r0001 ... r9999 (read-only)
p0001 ... p9999 (read and write-enabled)

The data you have entered are written to the data memory immediately. An exception is the drive machine data. To save the drive machine data permanently, set the parameter p971 in the SINAMICS for each individual drive object separately or set p977 of the CU_I to "1" and wait until it is reset automatically. If you forget to save the data, the old data is effective again after the next drive reset.

The machine data is activated depending on the machine data property "Activated".

8.5 Activating the high-speed digital inputs/digital outputs

Setting the Machine Data

The high-speed digital inputs/outputs are activated using the following machine data:

MD10350	FAST_DIG_NUM_INPUTS
MD10360	FAST_IO_DIG_NUM_OUTPUTS
MD10366	HW_ASSIGN_DIG_FASTIN[0]
MD10368	HW_ASSIGN_DIG_FASTOUT[0]

Example

The machine data MD10350 and MD10360 will be or are already set to 2. The machine data MD10366 and MD10368 must be input as follows (MCPA module as optional module 1 of the local bus):

4. Byte:	00	Segment number for LOCALBUS
3. Byte:	01	Module number (MCPA)
2. Byte:	01	Interface-module number
1. Byte:	01	I/O byte number

Table 8-1 Example of machine data setting

Machine data		Value	Explanation
MD10350	FAST_IO_DIG_NUM_INPUTS	2	Number of input bytes *)
MD10360	FAST_IO_DIG_NUM_OUTPUTS	2	Number of output bytes *)
MD10366	HW_ASSIGN_DIG_FASTIN[0]	00 01 01 01	Hardware assignment MCPA
MD10368	HW_ASSIGN_DIG_FASTOUT[0]	00 01 01 01	Hardware assignment MCPA

*) The first I/O byte is reserved for Sinamics.

The example shows that a total of 2 bytes for inputs/outputs are available. The MCPA inputs/outputs are arranged by addresses according to the always reserved addresses for onboard I/Os. Within part programs, the MCPA inputs/outputs can therefore be addressed by bits as follows:

- Inlets: \$A_IN[9] ... \$A_IN[16]
- Outlets: \$A_OUT[9]...\$A_OUT[16]

```

...
N100 R1= $A_IN[9]      ; Reading digital input 1 of the MCPA module
N200 $A_OUT[16] = 1    ; writing a 1 on the last digital output of the MCPA module
N300 R2=$A_OUT[16]    ; Reading of the output Bit8
    
```

8.6 Setting the Profibus addresses

Each bus station must be assigned a PROFIBUS DP address at the PROFIBUS-DP for unambiguous identification. Each PROFIBUS-DP address must be assigned at the bus only once.

Table 8-2 Setting the Profibus address

MD 11240[2]	PB station (slave)	PB address
0	PP module 1	9
	PP module 2	8
	PP module 3	7
	Additional preconfigured PB station: DP-DP coupler	6

PCU

The PCU is the master on the PROFIBUS. The address cannot be changed

PP 72/48

The PP 72/48 I/O module is the slave on the PROFIBUS. max. three PP modules can be connected. The PROFIBUS-DP address is set using the DIL switch S1 (on the PP module). Use a screw driver to set the PROFIBUS-DP address. It results from adding the switches that are in the "ON" position (left).

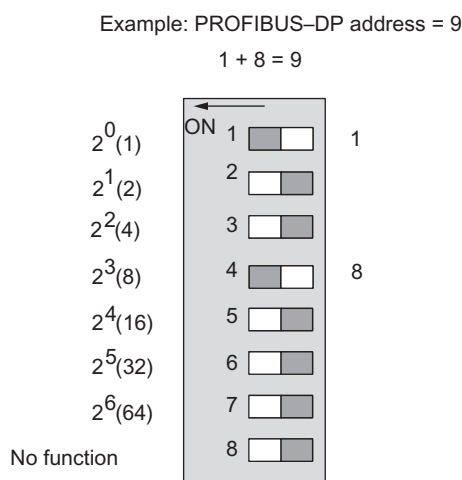

Figure 8-7 Setting the PROFIBUS DP address on PP72/48

Table 8-3 Setting the Profibus address on the PP 72/48

PB address	DIL switch S1 (PP module)
9 (default setting) (PP module 1)	1 + 4 = ON 2 + 3 + 5 + 6 + 7 + 8 = OFF
8 (PP module 2)	4 = ON 1 + 2 + 3 + 5 + 6 + 7 + 8 = OFF
7 (PP module 3)	1 + 2 + 3 = ON 4 + 5 + 6 + 7 + 8 = OFF

Note

The newly set PB station address is only active after POWER ON.

Use of three PP 72/48 I/O modules

If three PP 72/48 I/O modules are used, the assignment of the input/output bytes will be as follows:

Table 8-4 Assignment of the input/output bytes

1. PP 72/48 I/O module, PROFIBUS DP address 9			
Connector	X111	X222	X333
Input byte	0...2	3...5	6...8
Output Byte	0...1	2...3	4...5
2. PP 72/48 I/O module, PROFIBUS DP address 8			
Connector	X111	X222	X333
Input byte	9...11	12...14	15...17

Output Byte	6...7	8...9	10...11
3. PP 72/48 I/O module, PROFIBUS DP address 7			
Connector	X111	X222	X333
Input byte	18...20	21...23	24...26
Output Byte	12...13	14...15	16...17

DP/DP coupler

The DP/DP coupler is the slave on the PROFIBUS. One DP/DP coupler can be connected at the most. The PROFIBUS–DP addresses are set via the DIL switch on the DP/DP coupler. Use a screw driver to set the PROFIBUS–DP address. It results from adding the switches that are in the "ON" position.

The PROFIBUS DP address 6 must be set at the DP/DP coupler on the part of SINUMERIK 802D sl (network 1 = DP1 – switch 2+4 on). The second address (network 2 = DP2) is user defined.

On the part of the 802D, first 16-byte digital inputs and then 16-byte digital outputs are parameterized by the fixed parameterization in the DP coupler. In the 802D, these are placed on the input bytes 18 ... 33 or the output bytes 12 ... 27.

Thus on the second side of the DP/DP coupler, you must mirror that by first setting the 16-byte digital outputs and then the 16-byte digital inputs. You are free to decide on which input/output bytes you place these in your control system. (see the SIMATIC DP/DP coupler manual)

You may quickly test the function in SINUMERIK 802D sl under System / PLC Status.

IB 27 B _ _ _ _ _

QB 18 B _ _ _ _ _

Table 8-5 Setting the Profibus address on the DP/DP coupler

PB address	DIL switch DP1 (SINUMERIK 802D sl) network 1
6	2 + 4 = ON

PB address	DIL switch DP2 (SINUMERIK 802D sl) network 2
can be freely selected.	can be freely selected.

When you use the DP/DP coupler, the following assignment of the input/output bytes result:

Table 8-6 Assignment of the input/output bytes

DP/DP coupler network 1, PROFIBUS DP address 6	
Input bytes	27 ... 42 (16 byte)
Output bytes	18 ... 33 (16 byte)

Changing the PROFIBUS–DP address

You can change the PROFIBUS–DP address once set at any time. However, the control system will accept the newly set PROFIBUS–DP address only after turning off / turning on the 24 V DC power supply.

See also

Digital inputs/outputs (Page 25)

8.7 Starting Up the PLC

After starting up the Profibus, a PLC user program is ready to run and can be used for further start-up. To load the PLC user program, use the Programming Tool.

The description for this can be found in section "PLC application download...".

8.8 Commissioning of drives (SINAMICS)

The following options are available for commissioning the SINAMICS S120 with the SINUMERIK 802D sl:

1. Commissioning via the HMI
2. Editing drive projects with the STARTER commissioning tool

The descriptions for this can be found in Chapter "Commissioning of drives".

8.9 Set the axis/spindle-specific machine data.

Setpoint/actual value assignment

The axis machine data MD 30130: CTRLOUT_TYPE can be used to switch the setpoint output, and MD 30240: ENC_TYPE can be used to switch the actual-value input between simulation and SINAMICS drive.

Table 8-7 Setpoint/actual value assignment

Machine data	Simulation	Normal operation
MD 30130	Value = 0 Simulation	Value = 1 In this case, the setpoint signals are output via Profibus.
MD 30240	Value = 0 Simulation	Value = 1 (INCR) or 4 (EnDat) In this case, the actual values are read in via Profibus.

Note

For simulation, MD 30130 **and** MD 30240 must be parameterized with "0".

To enable the relevant NC axis to assign its setpoint to the appropriate SINAMICS drive, ensuring that the actual values are returned from this SINAMICS drive, it is imperative to parameterize the machine data MD 30110: CTRLOUT_MODULE_NR and MD 30220: ENC_MODULE_NR.

The following applies for the maximum configuration of 6 axes with Active Line Module:

Table 8-8 maximum configuration

Axis	Drive number MD 30110 MD 30220	SINAMICS object no.
SP	1	3
X1	2	4
Y1	3	5
Z1	4	6
A1	5	7
PLC axis	6	8

If this setting does not match the order in the drive group (the order of the DRIVE-CLiQ connections corresponds to the order of the SINAMICS object no., here: 1. CU, 2. ALM, 3. Spindle, 4. X1 axis, 5. Y1 axis, 6. Z1 axis, 7. A1 axis, 8. PLC axis), the data must be adapted accordingly.

Example 1:

Milling machine/nibbling machine with three axes and one spindle.

- The technology data block (setup_M.arc) has been loaded.
- The bus configuration has been selected with MD 11240[2] = 0.
- Now, adapt the axis machine data MD 30110: CTRLOUT_MODULE_NR and MD 30220: ENC_MODULE_NR are adapted as follows:

Table 8-9 Adapting the axis machine data for the milling machine

Axis	Drive number MD 30110 MD 30220	Sinamics object no.
X1	2	4
Y1	3	5
Z1	4	6
SP	1	3

Table 8-10 Adapting the axis machine data for the nibbling machine

Axis	Drive number MD 30110 MD 30220	Sinamics object no.
X1	2	4
Y1	3	5
SP	1	3

- Set the PB addresses = object no. of the drives as specified in the table above. Due to the fact that the 5th axis (A1) is not used, MD 20070: AXCONF_MACHAX_USED[4]=0 must be parameterized. This will remove the axis from the configuration of the NC.

Example 2:

Lathe/grinding machine with two axes and one spindle/two spindles.

- The technology data block (setup_T.arc) has been loaded.
- The bus configuration has been selected with MD 11240[2] = 0.
- Now, adapt the axis machine data MD 30110: CTRLOUT_MODULE_NR and MD 30220: ENC_MODULE_NR are adapted as follows:

Table 8-11 Adapting the axis machine data

Axis	Drive number MD 30110 MD 30220	Sinamics object no.
X1	2	4
Y1	3	5
SP	1	3
A1	4	6

- Set the PB addresses = object no. of the drives as specified in the table above. Due to the fact that the 5th axis (A1) is not used, MD 20070: AXCONF_MACHAX_USED[4]=0 must be parameterized. This will remove the axis from the configuration of the NC.

8.9.1 Default settings of the axis machine data for feed axes

The following machine data list summarizes all default data or their recommended settings with SINAMICS S120 drives connected.

Once they have been set, the axes are ready to traverse, and only a fine adjustment (reference point approach, software limit switches, position controller optimization, speed feedforward control, lead error compensation,...) must be performed. For further details, see: /FB/ SINUMERIK 802D sl description of functions.

Note

For feed axes, only parameter set 1 = index [0] is used. Index [1] ... [5] must only be parameterized when using the switch set of parameters function (see FB Chapter 3), G331 "Rigid tapping" or G33 (see FB Chapter 11). In this section, the values must only be entered in index [0].

Table 8-12 Default settings of the axis machine data for feed axes

MD	Name	Default value	Unit	Remarks
31030	LEADSCREW_PITCH	10	mm	Leadscrew of the ballscrew
31050	DRIVE_AX_RATIO_DENOM	1		Load gear transmission ratio Revolutions of the ballscrew Motor revolutions
31060	DRIVE_AX_RATIO_NUMERA	1		
32000	MAX_AX_VELO	10000	mm/min	Maximum axis velocity
32300	MAX_AX_ACCEL	1	m/s ²	Maximum axis acceleration
34200	ENC_REFP_MODE	1		1: Incremental encoder Motor order no: 1Fx6xxx-xxxxx- xAxx 0: EnDat encoder Motor order no: 1Fx6xxx-xxxxx- xExx
36200	AX_VELO_LIMIT	11500	mm/min	Threshold value for velocity monitoring; setting rule: MD 36200 = 1.15 x MD 32000

Example:

Motor with incremental encoder
 Gear ratio: 1:2
 Leadscrew pitch 5 mm
 max. axis speed 12 m/min
 max. axis acceleration 1.5 m/s²
 Machine data settings:
 MD 31030 = 5
 MD 31050 = 1
 MD 31060 = 2
 MD 32000 = 12000
 MD 32300 = 1.5
 MD 36200 = 13800

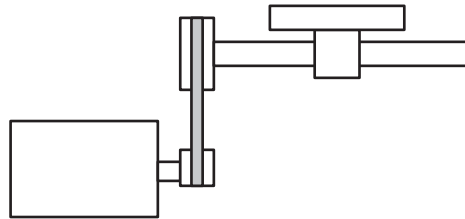

The axis can now be traversed. The direction of movement can be reversed using MD 32100: AX_MOTION_DIR = 1 or -1 (without influencing the control direction of the position control).

8.9.2 Default settings of the axis machine data for the spindle

With SINUMERIK 802D sl, the spindle is a subfunction of the entire axis functionality. The machine data of the spindle are therefore to be found amongst the axis machine data (MD 35xxx).

For this reason, data must also be entered for a spindle; this data has already been described in conjunction with the start-up of feed axes.

The following variants are offered for the spindle drive:

- digital spindle drive (PROFIBUS) with spindle actual-value encoder integrated into the motor
- digital spindle drive with motor encoder and directly mounted spindle actual-value encoder
- analog spindle drive with directly mounted spindle actual-value encoder
- Analog spindle without spindle actual-value encoder

Note

For spindles without gearstage switching, only gear stage 1 = index [1] is taken into account; index [2] ... [5] must only be parameterized when using the "Switch gearstage" function (see /FB/ Chapter 5).

Table 8-13 Default settings of the axis machine data for the spindle

MD	Name	Default value	Unit	Remarks
30200	NUM_ENCS	1		0: spindle without speed actual-value encoder (AM mode = operation without encoder) 1: spindle with speed actual-value encoder integrated into the motor (1PH7 motor)
31050	DRIVE_AX_RATIO_DENOM[1]	1		Load gear transmission ratio Load revolutions Motor revolutions
31060	DRIVE_AX_RATIO_NUMERA[1]	1		
35100	SPIND_VELO_LIMIT	10000	rpm	Maximum spindle speed
35130	GEAR_STEP_MAX_VELO_LIMIT[1]	500	rpm	Max. speed in gear stage 1
35200	GEAR_STEP_SPEEDCTRL_ACCEL[1]	30	rev/s ²	Acceleration in the speed control mode

digital spindle drive (PROFIBUS) with spindle actual-value encoder integrated into the motor

Parameterize the machine data listed in the previous table.

Example:

8.9 Set the axis/spindle-specific machine data.

Motor with incremental encoder
 Gear ratio: 1:2
 max. spindle speed 9000 rev/min
 max. spindle acceleration 60 rev/s²
 Machine data settings:
 MD 31050 = 1
 MD 31060 = 2
 MD 35100 = 9000
 MD 35130 = 9000
 MD 35200 = 60
 MD 36200 = 9900

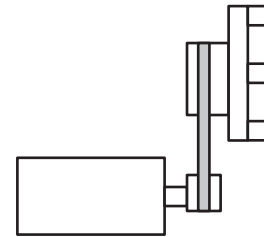

For the spindle, it can be necessary to adapt the following additional machine data.

Table 8-14 Additional machine data

MD	Name	Default value	Unit	Recommendation/remark
34000	REFP_CAM_IS_ACTIVE	1		0: without reference point cam
34060	REFP_MAX_MARKER_DIST	20	Degr.	720_ = two spindle revolutions
34110	REFP_CYCLE_NR	1 ... 5		0: The spindle is not involved in channel-specific referencing.
35300	SPIND_POSCTRL_VELO	500	rpm	
36000	STOP_LIMIT_COARSE	0,04	Degr.	0,4
36010	STOP_LIMIT_FINE	0,01	Degr.	0,1
36030	STANDSTILL_POS_TOL	0,2	Degr.	1
36060	STANDSTILL_VELO_TOL	0,0139	rpm	1 (interface signal "Axis/spindle stopped" V390x0001.4)
36400	CONTOUR_TOL	1	Degr.	3

digital spindle drive with motor encoder and directly mounted spindle actual-value encoder (TTL)

Operating a second measuring system requires the following machine data settings.

Table 8-15 Machine data to be set

MD	Name	Value	Recommendation/remark
30220	ENC_MODULE_NR[0]	3	Here you must enter a module number to which the measuring system is connected for the second measuring system (e.g. "3").
30230	ENC_INPUT_NR[0]	2	DRIVE-CLIQ_slot on the module to which the second measuring system has been connected
32110	SENC_FEEDBACK_POL[0]	-1	If necessary, swap the counting direction

Analog spindle with spindle actual-value encoder

Hardware requirement:

The MCPA module must be available. (see Chapter "Connecting an analog spindle")

Table 8-16 Machine data settings for analog spindle

Machine data		Value	Explanation
MD30100	CTRLOUT_SEGMENT_NR	0	Addressing local segment (onboard)
MD30110	CTRLOUT_MODULE_NR	1	Module No. 1
MD30120	CTRLOUT_NR	1	Output No. 1
MD30130	CTRLOUT_TYPE	1	real standard output
MD30134	IS_UNIPOLAR_OUTPUT	0	0: bipolar; >0: Unipolar
MD32250	RATED_OUTVAL	100	100% control (10 V)
MD32260	RATED_VELO	3300	cause this speed
MD30230	ENC_INPUT_NR	2	Input No. 2 (2nd encoder)

Since the MCPA module does not have an encoder connection, it is only possible to use an encoder if it is available as a 2nd encoder of a SINAMICS axis. This 2nd encoder must be configured within SINAMICS in such a manner that it is contained in the message frame and is thus available to the controller.

Analog spindle without spindle actual-value encoder

For an analog spindle without encoder, the same machine data apply as for an analog spindle with directly mounted encoder, but MD 30240 must be set to zero.

Unipolar spindle for SINUMERIK 802D sl

MD 30134 = 1 Unidirectional D/A value type "1"

MD 32100 = 1 Positive assignment, no inversion

MD 32100 = -1 Positive assignment, inversion

Machine data		Direction of spindle rotation	Voltage	Setpoint display	VB38020004
30134 = 1	32100 = 1	Spindle CW	>0	-	Bit 6 = 1
		Spindle CCW	>0	+	Bit 7 = 1
30134 = 1	32100 = -1	Spindle CW	>0	-	Bit 6 = 1
		Spindle CCW	>0	+	Bit 7 = 1

MD 30134 = 2 Unidirectional D/A value type "2"

MD 32100 = 1 Positive assignment, no inversion

MD 32100 = -1 Positive assignment, inversion

Machine data		Direction of spindle rotation	Voltage	Setpoint display	VB38020004
30134 = 2	32100 = 1	Spindle CW	>0	-	Bit 6 = 1

Machine data		Direction of spindle rotation	Voltage	Setpoint display	VB38020004
		Spindle CCW	>0	+	Bit 7 = 1
30134 = 2	32100 = -1	Spindle CW	>0	-	Bit 6 = 1
		Spindle CCW	>0	+	Bit 7 = 1

Example: Configuration for 3 axes with an analog spindle

Output of an analog setpoint for a spindle drive for connecting a third-party converter (e. g. MICROMASTER). With software release 01.01, connection is possible via the MCPA module.

ALM; 1-axis module; 1-axis module; 1-axis module

Table 8-17 Machine data for the example

MD	Name	X	Y	Z	SP	Remarks
30100	CTRLOUT_SEGMENT_NR	5	5	5	0	local bus segment for analog
30110	CTRLOUT_MODULE_NR	2	3	1	1	Module order
30120	CTRLOUT_NR	1	1	1	1	Setpoint output on drive module/module
30130	CTRLOUT_TYPE	1	1	1	1	Output value of the setpoint values
30134	IS_UNIPOLAR_OUTPUT	0	0	0	0	The setpoint output is unipolar
30200	NUM_ENCS	1	1	1	1	Number of encoders
30220	ENC_MODULE_NR	2	3	1	3	Transport module (the SMC30 module is connected to the axis module of the Y axis)
30230	ENC_INPUT_NR	1	1	1	2	Input on the drive module (X202)
30240	ENC_TYPE	4	1	1	1	Encoder kind
32250	RATED_OUTVAL (spindle)	80				Rated output voltage 8 V at $U_{max/min}$
32260	RATED_VELO (spindle)	3200				Rated motor speed at 8 V

Thereafter, set the following machine data:

Table 8-18 Additional machine data

MD	Name	Default value	Recommendation/remark
11240[2]	PROFIBUS_SDB_NUMBER	0	
13060[2]	DRIVE_TELEGRAM_TYPE	116	Standard message frame type for Profibus-DP

If the transport module is the 3rd axis (example: Y).

Table 8-19 Additional machine data

MD	Name	Default value	Unit	Recommendation/remark
34000	REFP_CAM_IS_ACTIVE	1		0: without reference point cam
34060	REFP_MAX_MARKER_DIST	20	Degr.	720_ = two spindle revolutions
34110	REFP_CYCLE_NR	1 ... 5		0: The spindle is not involved in channel-specific referencing.
35300	SPIND_POSCTRL_VELO	500	rpm	
36000	STOP_LIMIT_COARSE	0,04	Degr.	0,4
36010	STOP_LIMIT_FINE	0,01	Degr.	0,1
36030	STANDSTILL_POS_TOL	0,2	Degr.	1
36060	STANDSTILL_VELO_TOL	0,0139	rpm	1 (interface signal "Axis/spindle stopped" V390x0001.4)
36400	CONTOUR_TOL	1	Degr.	3

8.9.3 PLC-controlled axis

Axes can be controlled via the PLC's NCK interface V380x3000 / V390x3000 (also see functional description of positioning axes P2). The following functions are supported:

- Positioning axis
- Indexing axis

Prerequisites

With the aid of the axial machine data MD 30460 MA_BASE_FUNCTION_MASK, one axis can be defined as a permanently assigned PLC axis. For this, the following values must be set: MD 30460 MA_BASE_FUNCTION_MASK=20H

The axis is a permanently assigned PLC axis. The axis can, however, be jogged and referenced. The axis cannot be assigned to the NC program. This property is displayed from the NCK to the PLC in the V390x0011.7 "PLC axis permanently assigned" signal.

The axis number of the PLC axis (the standard case is 6) is to be entered subsequently at the parameterized NC axis.

Example: Lathe with 2 axes and 1 spindle

Table 8-20 Adapting the axis machine data

Axis	MD 20070
X1	[0]=1
Z1	[1]=2
SP	[2]=3
PLC	[3]=6

Note

The PLC axis control is activated by the positive edge of the "Start" signal. The "Start" signal must remain in the logic "1" state until the PLC axis control has been acknowledged positively or negatively by "Position reached" = "1" or Error = "1". The signal "Positioning axis active" = "1" indicates that the PLC axis control is active and that the output signals are valid

Abort

The PLC axis control cannot be aborted by means of parameter "Start", but only by means of the axial interface signals (e.g., delete distancetogo). The axial interface also returns status signals of the axis that may need to be evaluated (e.g., exact stop, traverse command).

Axis disable

With the axis disabled, an axis controlled via PLC axis control will not move. Only a simulated actual value is generated. (Behavior as with NC programming).

Fault detection

If a PLC axis control could not be executed, this is indicated by the signal error (V390x3000.1 or V390x3000.0) with 'logic 1'. The cause of the error is coded as an error number.

Explanation of the signals

All of the signals of the PLC axis control function are compiled in the following table.

Table 8-21 PLC axis control signals

Signal		Type	Remarks
Control signals PLC --> NCK			
V380x3000.7	Start	Bool	0->1= Start spindle control from PLC
V380x3002.0	Preparatory function, incremental (IC)	Bool	1 = IC
V380x3002.1	Preparatory function, shortest path (DC)	Bool	1 = DC
V380x3002.2	Traversing dimension inch	Bool	1 = positioning axis inch, i.e. not metric
V380x3003.0	Preparatory function abs. neg. direction (ACN)	Bool	1 = ACN
V380x3003.1	Preparatory function abs. pos. direction (ACP)	Bool	1 = ACP
V380x3003.7	Indexing position	Bool	1 = Indexing axis

Signal		Type	Remarks
VD380x3004	Item	Real	Rotary axis: Degree linear axis: mm or inches
		DWord	Indexing axis: Indexing position
VD380x3008	Feedrate	Real	Rotary axis and spindle: RPM See under table containing info about FRate
Feedback: NCK ->PLC			
V390x3000.0	Axis cannot be started	Bool	1 = error
V390x3000.1	Error during traversing	Bool	1 = error
V390x3000.6	Position reached	Bool	1 = In position
V390x3000.7	Positioning axes active	Bool	Positioning axis active, feedback valid
VB390x3003	Error code	Byte	see Table

Explanation:

The signals IC, DC, ACP, ACN may only be alternately in effect or none. If no signal is set, the AC is in effect (Absolute Coordinate).

Error messages

Table 8-22 Error messages via NCK

Errors that occur due to handling of the NCK.		
30	16#1e	The axis/spindle has been transferred to the NC while still in motion
50	16#32	permanently assigned PLC axis jogs or references
60	16#3C	Permanently assigned PLC axis channel status does not currently permit a start
100	16#64	Corresponds to interrupt number 16830
105	16#69	Corresponds to interrupt number 16770
106	16#6a	Corresponds to interrupt number 22052
107	16#6b	Corresponds to interrupt number 22051
108	16#6c	Corresponds to interrupt number 22050
109	16#6d	Corresponds to interrupt number 22055
110	16#6e	Velocity/speed is negative
111	16#6f	Setpoint speed is zero
112	16#70	Invalid gear stage
115	16#73	Programmed position has not been reached
117	16#75	G96/G961 is not active in the NC
118	16#76	G96/G961 is still active in the NC
120	16#78	Not an indexing axis
121	16#79	Indexing position error
125	16#7d	DC (shortest path) not possible
126	16#7e	Minus absolute value not possible
127	16#7f	Plus absolute value not possible
130	16#82	Software limit switch Plus
131	16#83	Software limit switch minus

132	16#84	Working area limitation plus
133	16#85	Working area limitation minus
135	16#8/	Corresponds to interrupt number 17501
136	16#88	Corresponds to interrupt number 17503
System or other serious interrupts		
200	16#c8	Corresponds to system interrupt number 450007

The alarms are described in: /DG/ SINUMERIK 802D sl "Diagnostics Guide"

Pulse diagram

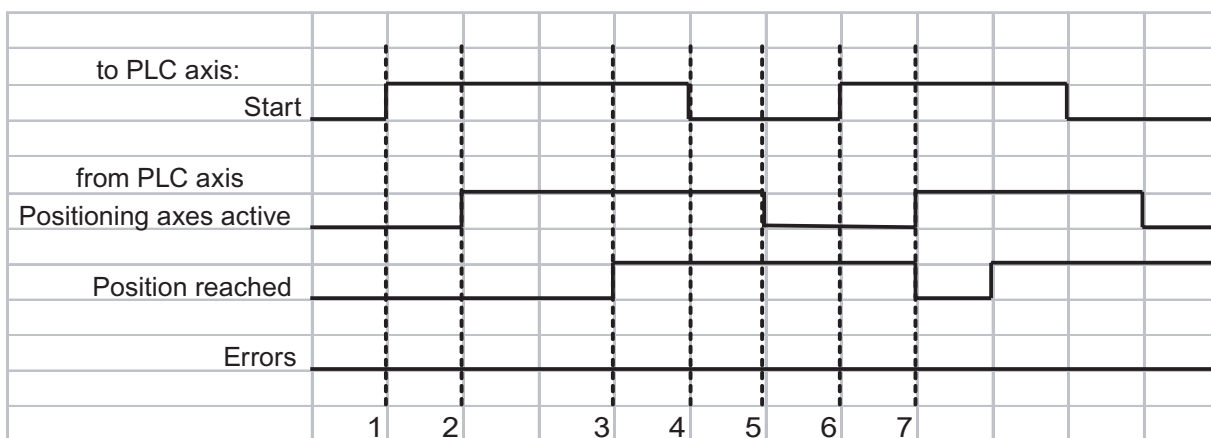

Figure 8-8 Pulse diagram normal condition

1. 1. Function activation via positive edge of *Start*
2. *Positioning axis active* = 1 shows that the function is active and that the output signals are valid
3. positive acknowledgement *Position reached* = 1 and *positioning axis active* = 1
4. Reset function activation after receipt of acknowledgment
5. Signal change via function
6. 2. Function activation via positive edge of *Start*
7. *Positioning axis active* = 1 shows that the function is active and that the output signals are valid

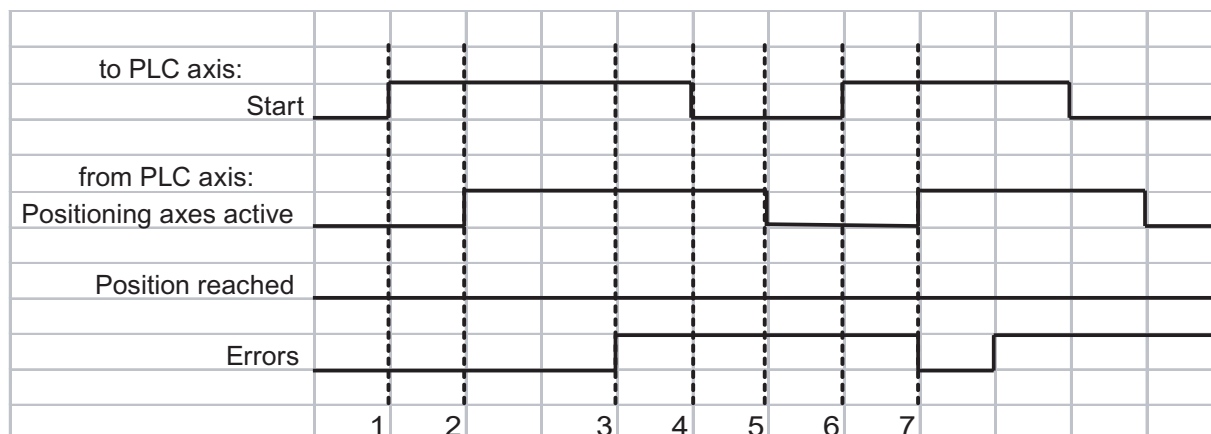

Figure 8-9 Pulse diagram (fault scenario)

1. 1. Function activation via positive edge of *Start*
2. *Positioning axis active* = 1 shows that the function is active and that the output signals are valid
3. negative acknowledgement *Error* = 1 and *Positioning axis active* = 1
4. Reset function activation after receipt of acknowledgment
5. Signal change via function
6. 2. Function activation via positive edge of *Start*
7. *Positioning axis active* = 1 shows that the function is active and that the output signals are valid

8.9.4 Completion of the commissioning of the axes/spindle

The general commissioning of the axes/spindle is completed. A fine optimization must still be carried out.

8.10 Completing the commissioning

After the start-up by the machine manufacturer has been completed, it is recommended to carry out a data backup prior to delivery to the end customer:

1. Performing an internal data backup (at least protection level 3 required):
 - Select the **<Save data>** softkey in the **System** operating area.
 - The drive machine data is saved automatically after the commissioning with HMI.
2. Carry out external data backup on customer CF card (see Chapter "Data backup and series commissioning")
3. Resetting the access level:
 - Select the **<Delete passw.>** softkey.

Commissioning the drives using HMI

HMI functions are available for commissioning and displaying the current status of the SINAMICS drives.

Operating sequence

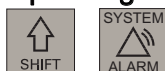

These can be found in the System operating area.

Machine data

The dialog box of the drive machine data is opened via the **<Mach. Data>** **<Drive MD>** softkeys.

Drive MD

The current configuration and the statuses of the control and infeed unit and the drive units are displayed.

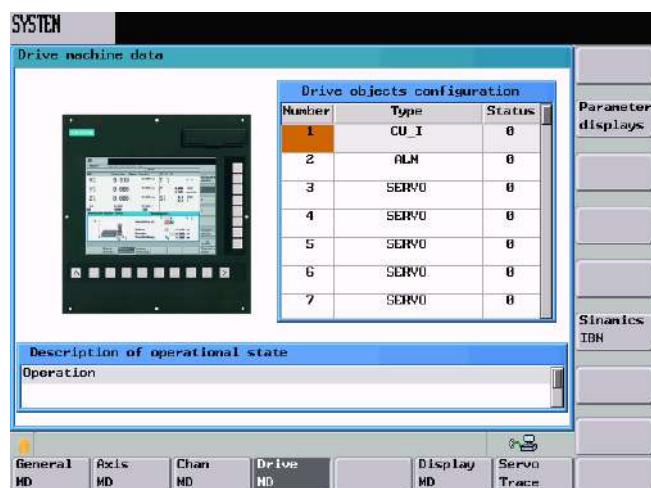

Figure 9-1 Drive machine data

With a set password (at least "user"), the **<Sinamics COMMISSIONING>** softkey appears, via which you can access the commissioning area.

Sinamics IBN

Pressing the **<Sinamics COMMISSIONING>** softkey opens the main screen "Commissioning the SINAMICS Components".

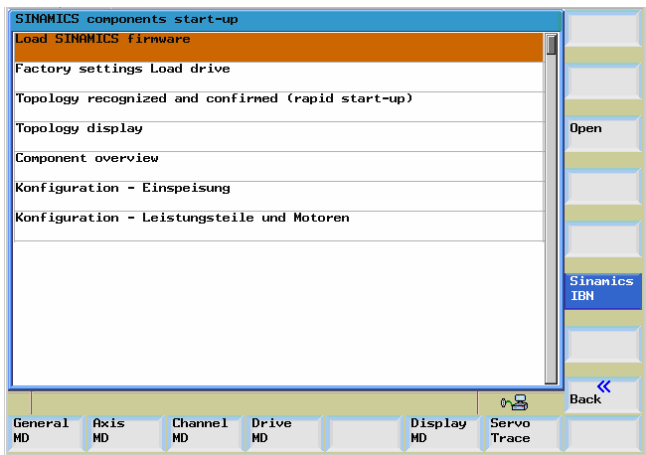
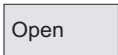
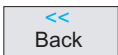

Figure 9-2 "SINAMICS Commissioning" main screen

Select the corresponding step using the cursor keys.



<Open> displays the selected area.



<Back> returns to the previous display.

Note

The execution of the individual steps must take place in the specified order, because, for example, the component overview cannot be created without a topology display. The basic prerequisite is the successful completion of the topology detection and confirmation.

Loading SINAMICS firmware

The SINAMICS firmware can be loaded for all components or only for individual components. If the "individual components" option is selected, the component number must be entered.

After pressing the <Start> softkey, a running bar appears via which the operator can track the progress of the download. The note "Please wait, download in progress" appears. During the download, the control system must not switched off.

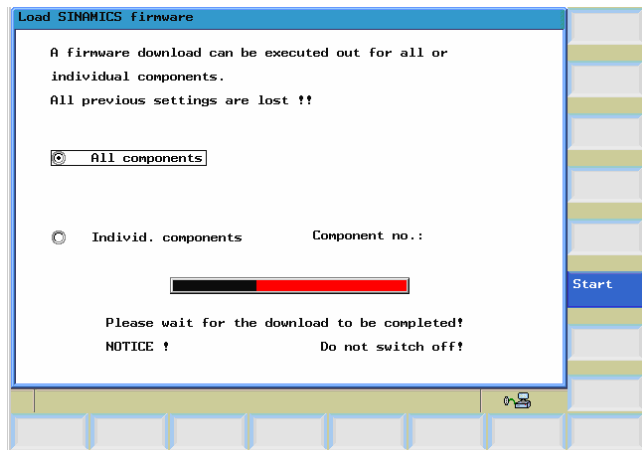

Figure 9-3 Loading SINAMICS firmware

To activate, a new start up is required after completion (Power off/on). The **<Back>** softkey reappears.

Load default settings for the drive (Parameter Reset)

The operator is notified that all previous SINAMICS parameters are cleared upon confirmation.

The parameter reset can be performed for all of the components or only for individual components. If the individual components option is selected, the component number must be entered.

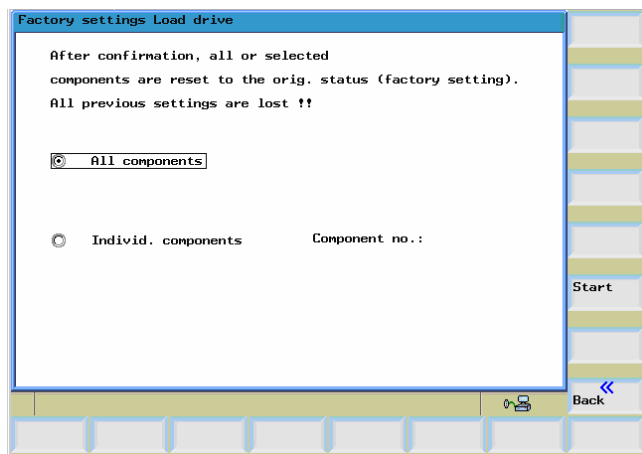

Figure 9-4 Loading the default settings for the drive

The process is carried out using the **<Start>** softkey. Successful completion is indicated in the lower part of the window in the form of informational text. **<Back>** returns you to the selection menu.

Detection and confirmation of the topology

The actual topology of the device (p0098[0]) is read-out and automatically entered in the parameter of the setpoint topology of the device (p0099[0]). Then the start of the quick

commissioning of the SINAMICS takes place with the entry of the Profibus protocol in each drive object and the BICO wiring. When this has ended, the parameter p0978[x] is automatically adapted to the existing configuration. The configuration is saved.

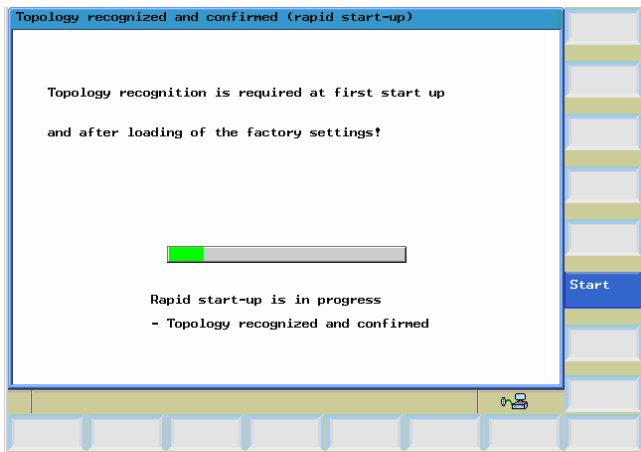

Figure 9-5 Quick start-up

The currently running procedure is documented in the lower part of the window in the form of a short text.

To activate the detected topology, a new start up is required after completion (Power off/on). The <Back> softkey reappears.

Displaying the topology

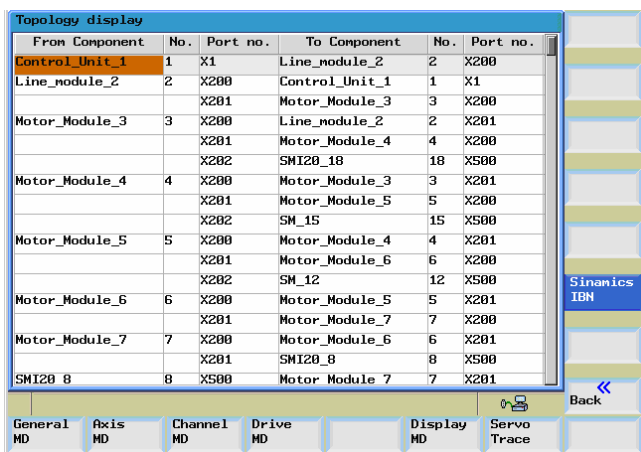

Figure 9-6 Topology Display

During the read-in and preparation of the data, which takes some time, a running bar is displayed. For repeated call-up, the screen appears immediately. The evaluated data are retained until "Power Off".

Overview of components

The component name, type, number and firmware version of all the components and the topology comparison stage are displayed in the component overview.

Component	-Type	No.	FW version	Comp.
CU_I_003.Control_Unit_1	SINUMERIK 002D s1	1	02.40.40.00	High
A_INF_02.Line_module_2	ALM_ACDC	2	02.40.40.00	High
SERVO_03.Motor_Module_3	MM_1AXIS_DCAC	3	02.40.40.00	High
SERVO_04.Motor_Module_4	MM_1AXIS_DCAC	4	02.40.40.00	High
SERVO_05.Motor_Module_5	MM_1AXIS_DCAC	5	02.40.40.00	High
SERVO_06.Motor_Module_6	MM_2AXIS_DCAC	6	02.40.40.00	High
SERVO_07.Motor_Module_7	MM_2AXIS_DCAC	7	02.40.40.00	High
SERVO_03.SMI20_18	SMI20	18	02.40.40.00	High
SERVO_04.SM_15	SMC20	15	02.40.40.00	High
SERVO_05.SM_12	SMC20	12	02.40.40.00	High

Component overview interface showing a table of components and a sidebar with 'Details' and 'Sinamics IBN' buttons. A 'Back' button is also visible at the bottom right.

Figure 9-7 Component overview

After pressing the **<Details>** softkey, a window appears with further details on the selected components.

Component overview in detail	
Component	CU_I_003.Control_Unit_1
-Type	SINUMERIK 002D s1
-Number	1
FW version	02.40.40.00
Order no.	6FC5370-0AA00-0AA0
HW version	
Serial no.	T-P30050000
Comp. level	0xffff
HMI description	SINUMERIK 002D solution line with DRIVE-CLiQ Ports

Component overview in detail interface showing a list of component attributes and a sidebar with 'Details' and 'Back' buttons. A 'Back' button is also visible at the bottom right.

Figure 9-8 further details on the components

Configuration of the infeed

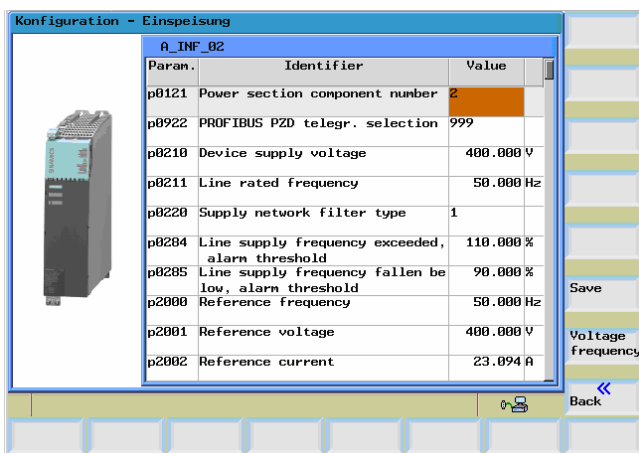

Figure 9-9 Configuration of the infeed

The current values are displayed in the screen form. If the configuration is not yet completed, new values can be entered. The screen form is completed with **<Save>**. **<Back>** returns you to the selection menu.

Configuration of the power sections and motors

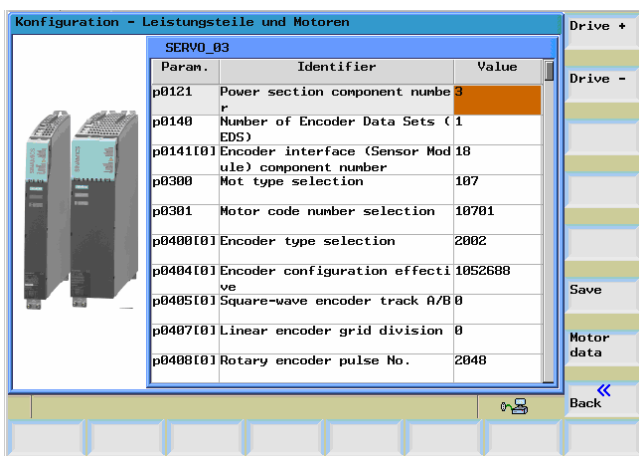

Figure 9-10 Configuration of the power sections and motors

The current values of the respective components are displayed in the screen form and can be reassigned. The entries are saved using the **<Save>** softkey. Using **<Drive+>** and **<Drive->**, you can switch between the individual power sections.

Parameter	Identifier	Value	Unit
p0304	Rated motor voltage	350.000	V
p0305	Rated motor current	9.760	A
p0307	Rated motor power	3.700	kW
p0308	Rated motor power factor	0.740	
p0309	Rated motor efficiency	0.000	
p0310	Rated motor frequency	51.610	Hz
p0311	Rated motor speed	1500.000	1/min
p0312	Rated motor torque	0.000	Nm
p0326	Motor stall torque correction factor	78.000	%
p0341	Motor moment of inertia	0.017	kgm ²
p0344	Motor weight	40.000	kg

Figure 9-11 Motor data

The <Motor data> softkey opens another window with motor data.

9.1 Terminal assignment X20 / X21

Table 9-1 Configuring the X20 clamp after SINAMICS commissioning using HMI

Pin no.	Function	Assignment	BICO source	BICO sink	Macro no.
1	Input 0/1 edge required	ON/OFF 1 Infeed Line Module with DRIVE-CLiQ Connection	CU: r0722.0	Infeed p840	150001
		"Infeed Ready Signal" of Line Module without DRIVE-CLiQ connection	SLM X21.1	Drive p864	150005
2	Input	"OFF3 – rapid stop" Function: braking with configurable OFF3 ramp (p1135, p1136, p1137) then pulse suppression and closing lock-out. The drive is stopped by prompts. The braking behavior can be separately set for each servo. Behavior similar to that of terminal 64.	CU: r0722.1	Each drive 2. OFF3, p849	150001 150005
3	Input	SH/SBC 1 - Group1 SINAMICS Safety Integrated (SH enable=p9601)	CU: r0722.2	p9620 (all drives in the group)	No preassignment
4	Input	SH/SBC 1 - Group2 SINAMICS Safety Integrated (SH enable=p9601)	CU: r0722.3	p9620 (all drives in the group)	No preassignment
5		Ground for pin 1 .. 4			
6		24 P			
7	Output	SH/SBC 1 - Group1 SINAMICS Safety Integrated (SH enable=p9601)	CU: p0738	p9774 Bit 1 BICO from CU after the first drive in the group	No preassignment

Commissioning the drives using HMI

9.1 Terminal assignment X20 / X21

Pin no.	Function	Assignment	BICO source	BICO sink	Macro no.
8	Output	SH/SBC 1 - Group2 SINAMICS Safety Integrated (SH enable=p9601)	CU: p0739	p9774 Bit 1 BICO from CU after the first drive in the group	No preassignment
9		Ground for pins 7, 8, 10, 11			
10	Input	Bero 1 – zero mark substitute"	CU: r0722.10	p495=1	--
11	Input	Probe 1 Decentralized Measuring (check that MD13210 = 1!)	CU: p0680[0] = 0	Every drive p488 Index = encoder 1,2,3 = 3	--
12		Ground for pins 7, 8, 10, 11			

Table 9-2 Configuring the X21 clamp after SINAMICS commissioning using HMI

Pin no.	Function	Assignment	BICO source	BICO sink	Macro no.
1	Input	Digital input \$A_IN[1]	CU: r0722.4	CU: p2082[0]	150001
2	Input	Digital input \$A_IN[2]	CU: r0722.5	CU: p2082[1]	150005
3	Input	Digital input \$A_IN[3]	CU: r0722.6	CU: p2082[2]	
4	Input	Digital input \$A_IN[4] Line contactor, feedback signal	CU: r0722.7	CU: p2082[3] LM : p0860	--
5		Ground for pin 1 .. 4			
6		24 P			
7	Output	Infeed Operation (Line Module with DRIVE-CLiQ Connection) Digital output \$A_OUT[4]	LM : r0863.0 CU: p2091.3	CU: p0742	150001 150005
8	Output	Infeed and operational readiness if Line Module with DRIVE-CLiQ connection Digital output \$A_OUT[3]	LM : r0899.0 CU: p2091.2	CU: p0743	150001 150005
9		Ground for pins 7, 8, 10, 11			
10	Output	Digital output \$A_OUT[2] Line contactor control	CU: p2091.1 LM : r0863.1	CU: p0744	150001 / 150005 --
	Input	Bero 2 – zero mark substitute 2. OFF 2	CU: r0722.14 CU: r0722.14	Drive: p0495=5 Drive: p0845	-- --
11	Output	Digital output \$A_OUT[1]	CU p2091.0	CU: p0745	150001 / 150005
	Input	Probe 2 Decentralized Measuring (check that MD13210 = 1!)	CU: p0680[1]=0 CU: p0728 Bit 15=0	each drive p489 Index = encoder 1,2,3 = 6	
12		Ground for pins 7, 8, 10, 11			

Selected status signals

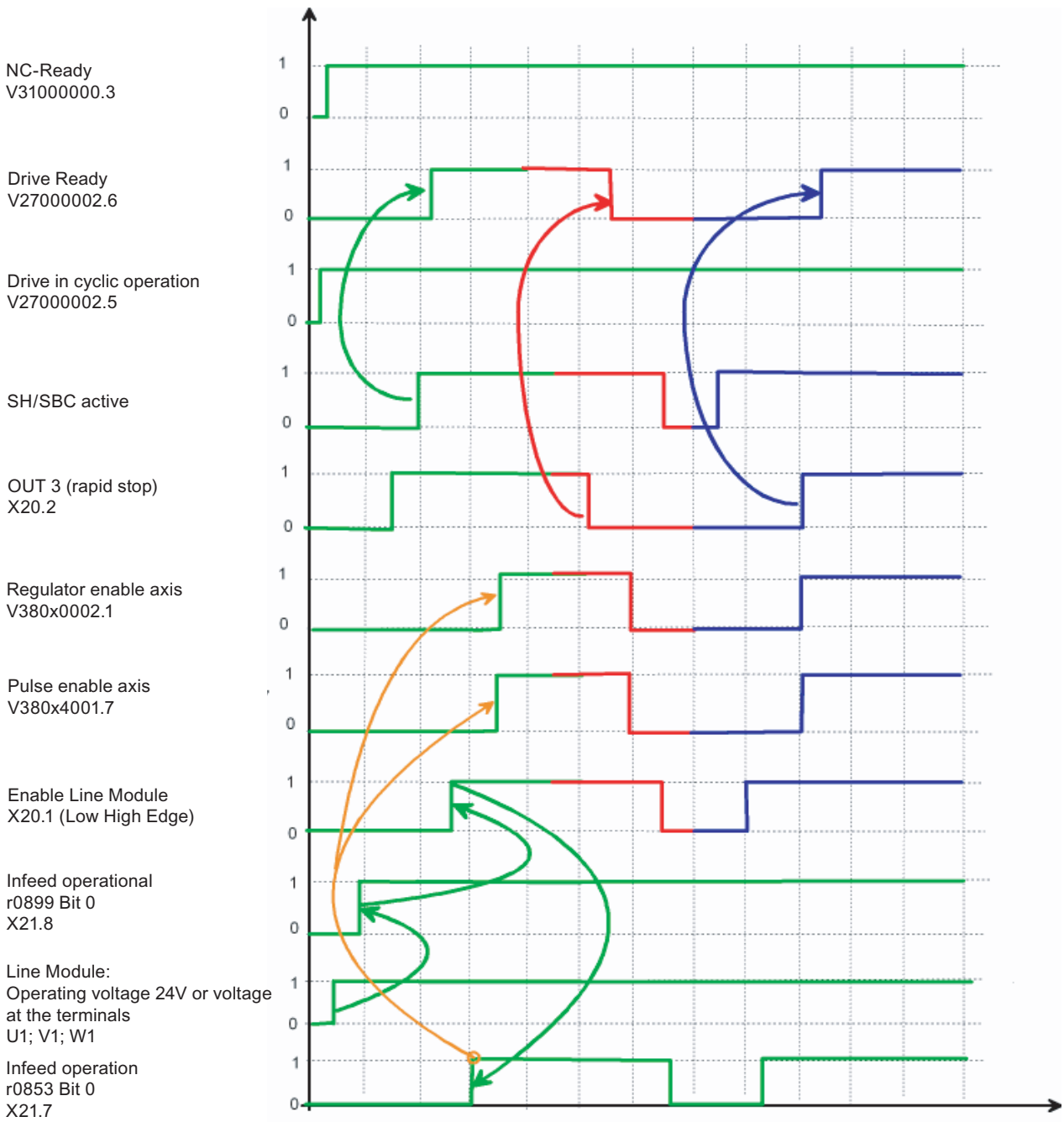

Edit a drive project with STARTER

10.1 Change a drive project OFFLINE

Prerequisites

- Components of the drive unit are assembled, completely wired (DRIVE-CLiQ)
- The commissioning via HMI has occurred (see Chapter "SINAMICS commissioning using HMI")

Sequence

To create a new project, proceed as follows:

1. Start the STARTER commissioning tool by clicking on the STARTER symbol or by the menu item **Start > Programs > STARTER > STARTER** in the Windows Start menu.
2. In the menu bar, select **Project > new** . The system displays the window **Insert single drive**.

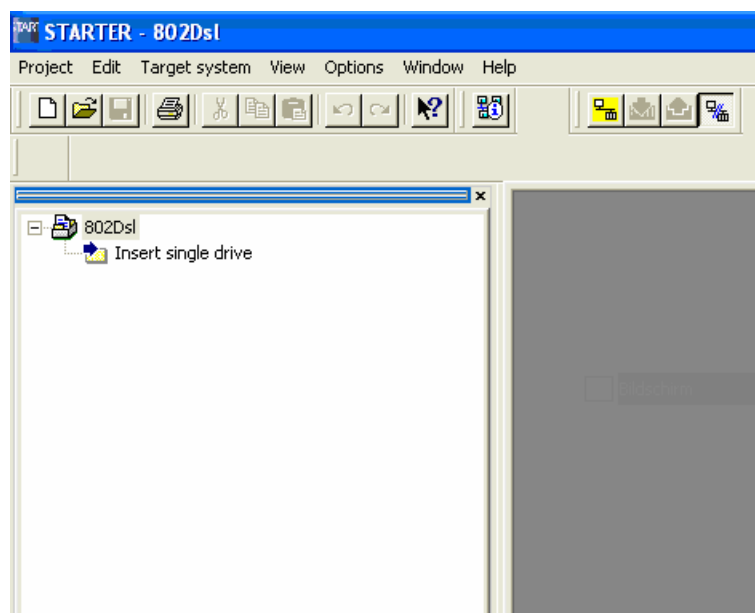

Figure 10-1 Inserting single drive

3. Selecting the device type with device version

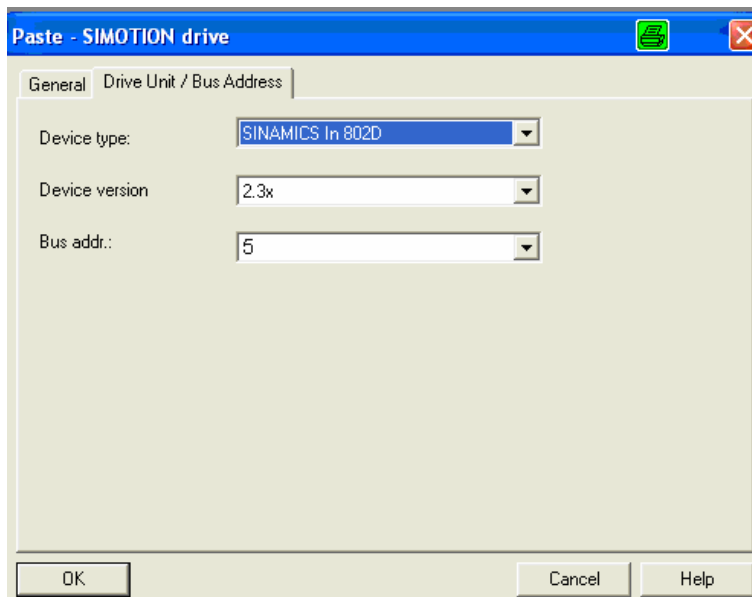

Figure 10-2 Device type with device version

Confirm your selection with **<OK>**; it is displayed as follows.

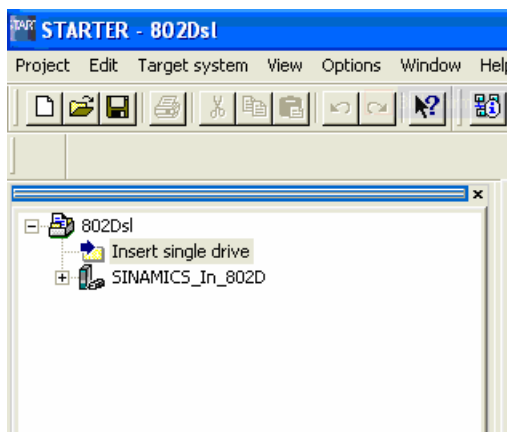

Figure 10-3 Displaying the selection

1. Activating the online access

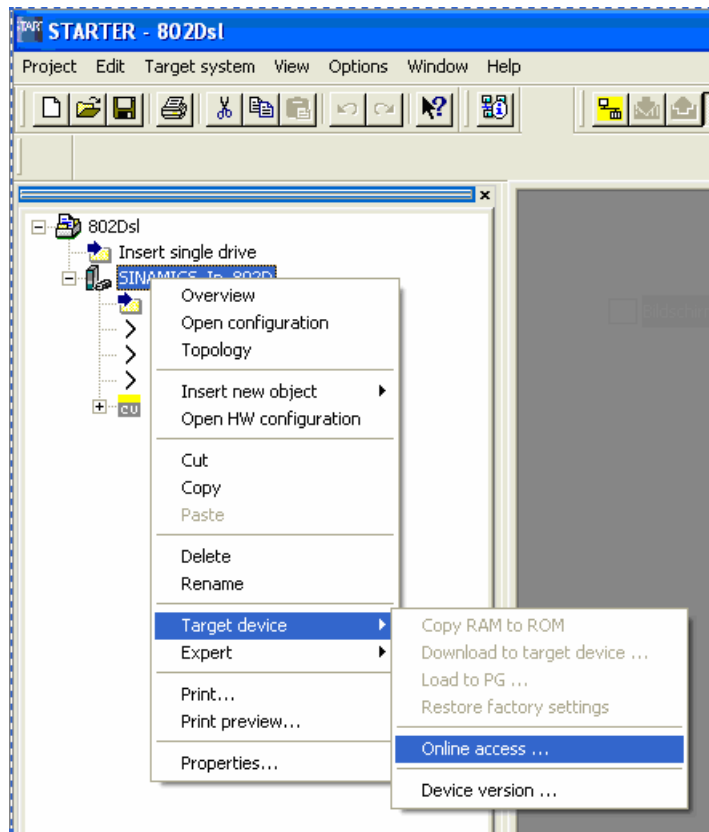

Figure 10-4 Selecting the online access

The online connection can be established via

- TCP/IP
- PPI.

The settings required are described in the point "Interface settings at the PC/PG".

2. Establish the online connection by pressing "Connect to target system".

Edit a drive project with STARTER
 10.1 Change a drive project OFFLINE

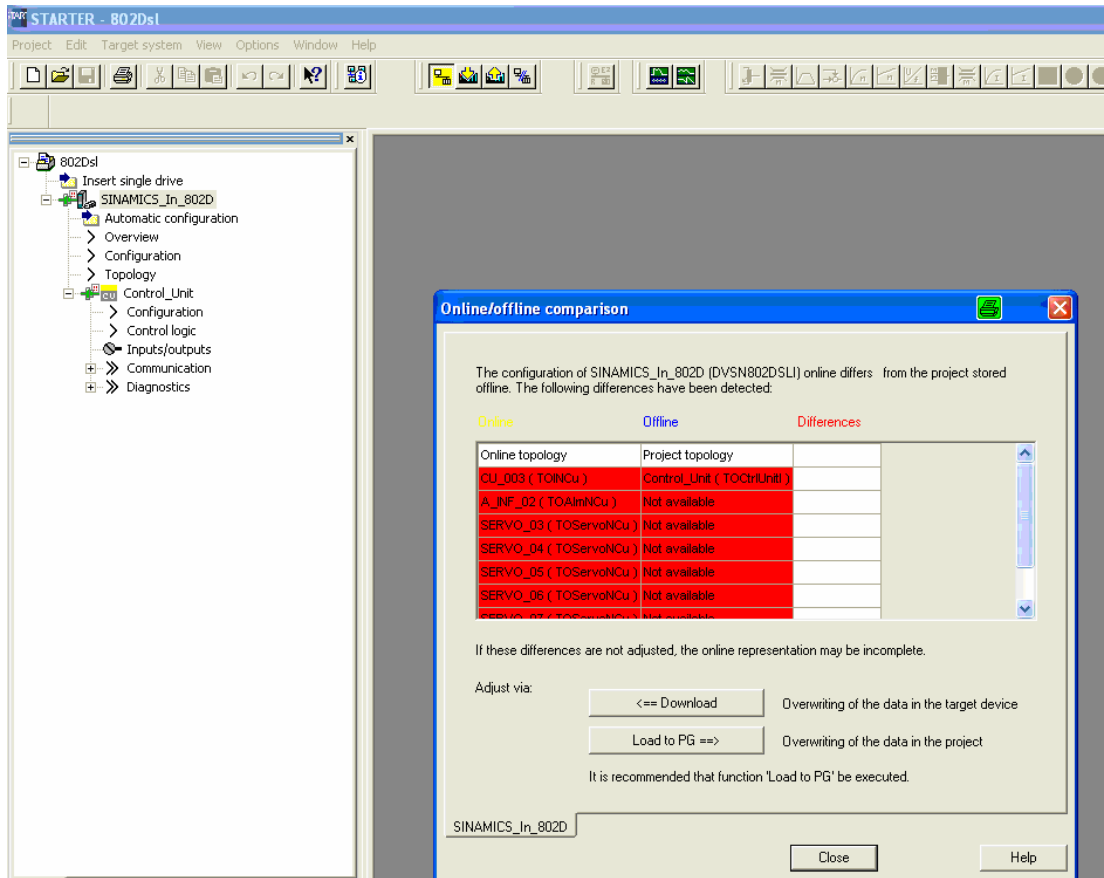

Figure 10-5 Online connection is established

3. To load the project into the PG, you must click on the **Load to PG ==>** button.

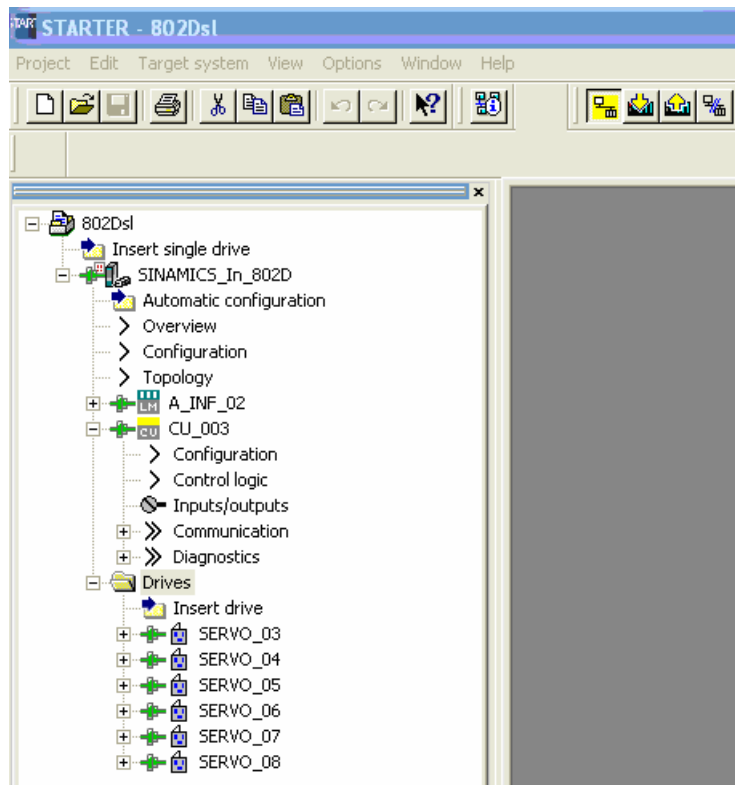

Figure 10-6 Loading the project to the PG

Now you can supplement/change the project OFFLINE.

10.1.1 Example: Commissioning a direct measuring system for a spindle

Sequence

1. In the project tree, select the drive to be changed and and open the configuration via double-click.

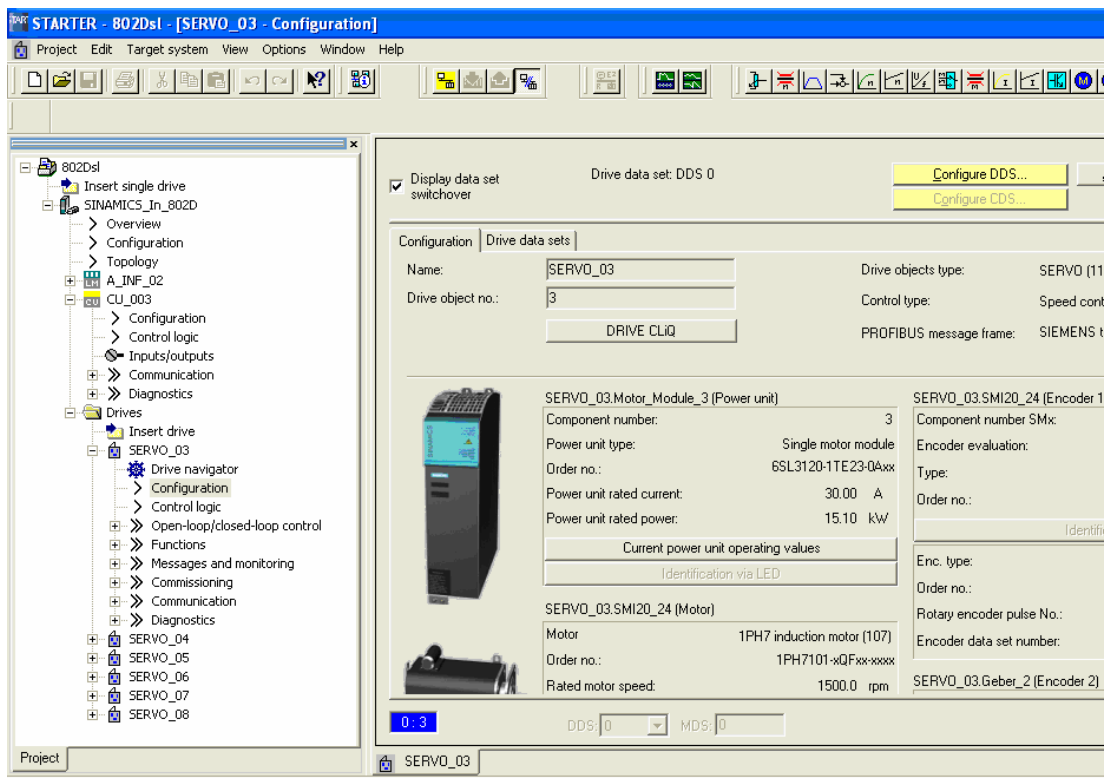

Figure 10-7 Selecting the drive in the project tree

2. Click on <Configure DDS...>

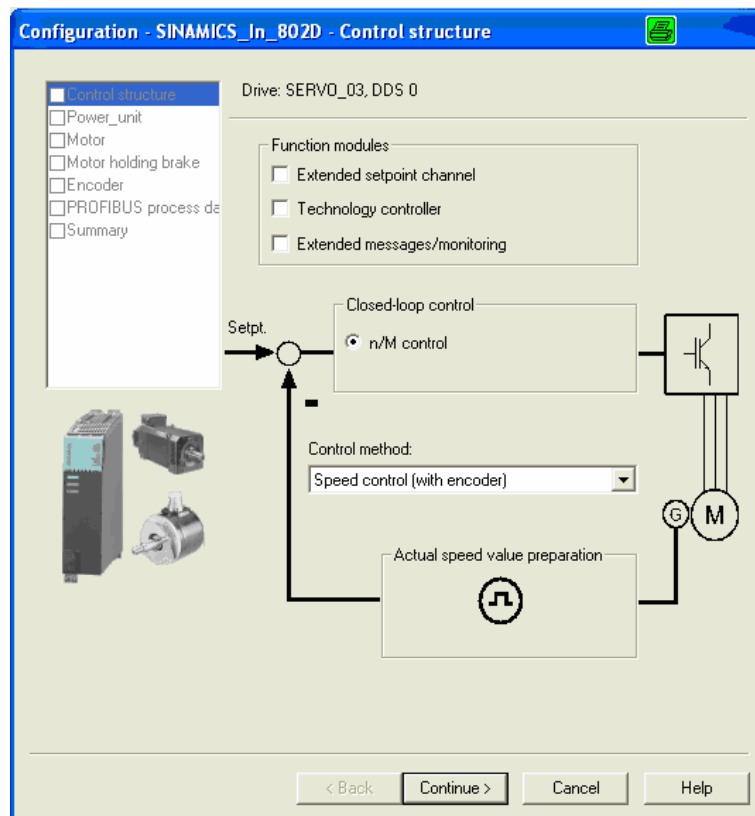

Figure 10-8 Configuration SINAMICS_IN_802D "Control structure"

3. Confirm the configuration with **<Continue>**. This also applies to the configuration window
 - Power_unit
 - Motor
 - Motor holding brake.

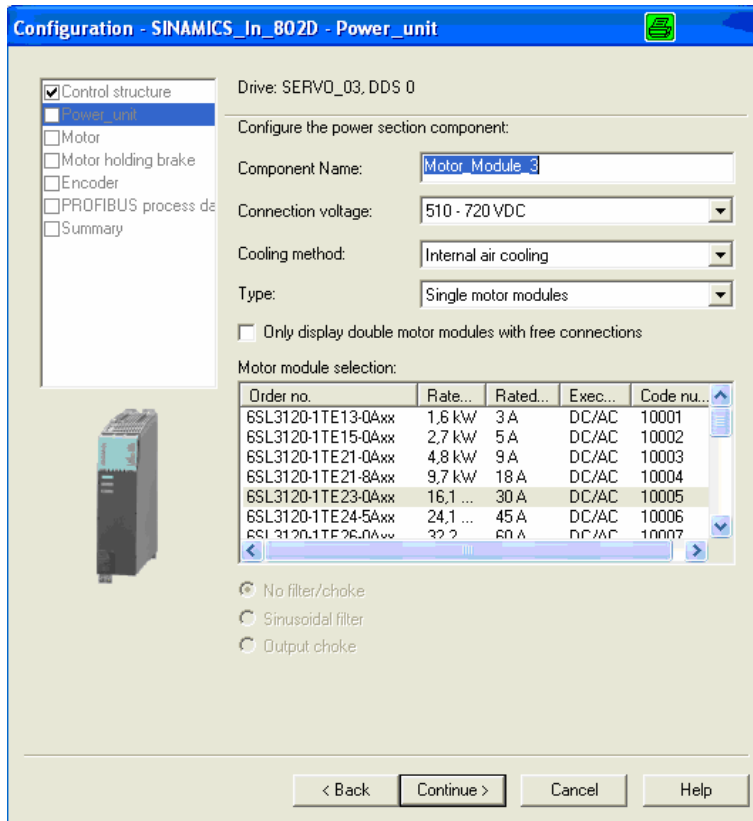

Figure 10-9 Configuration "Power_unit"

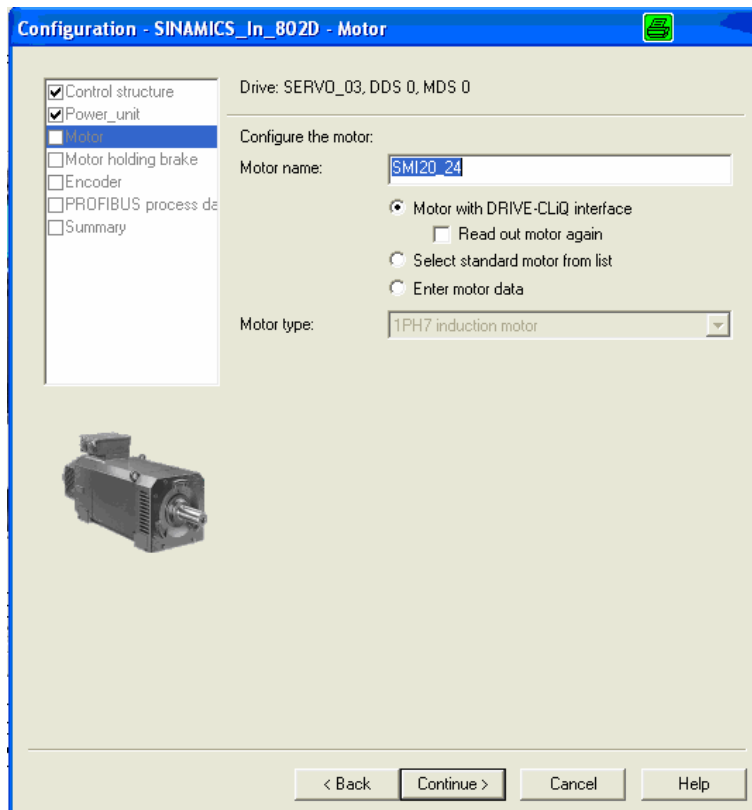

Figure 10-10 Configuration "Motor"

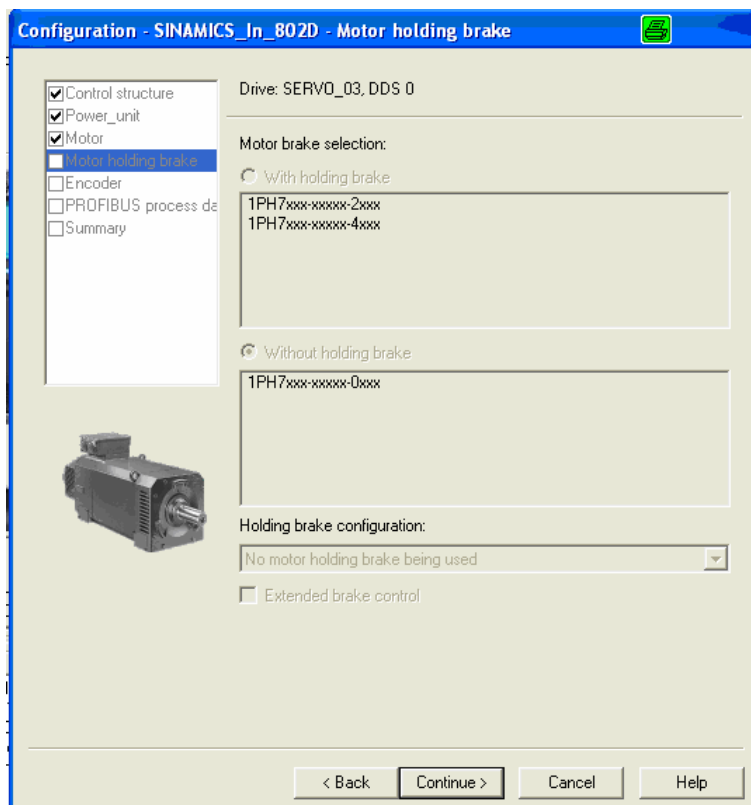

Figure 10-11 Configuration "Motor holding brake"

4. In the encoder configuration window, select the encoder data.

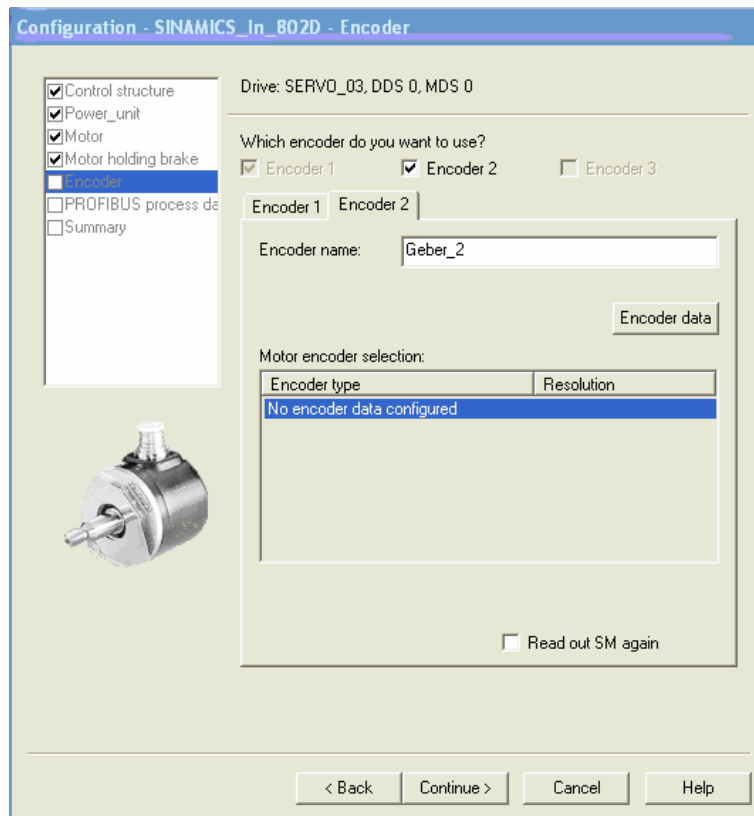

Figure 10-12 Configuration "Encoder"

For this, click on **<Encoder data>**. In the subsequent window, select the encoder data (e.g. incremental rotary encoder).

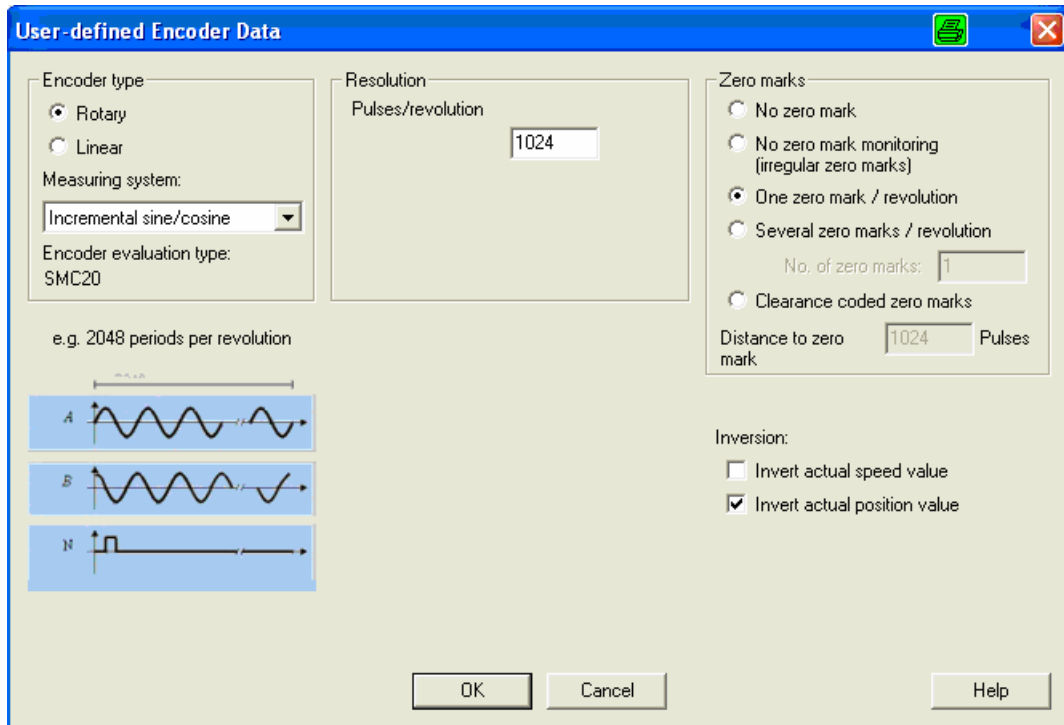

Figure 10-13 Selection screen for encoder data

Complete the entry with **<OK>**. As confirmation, the system generates the following screen.

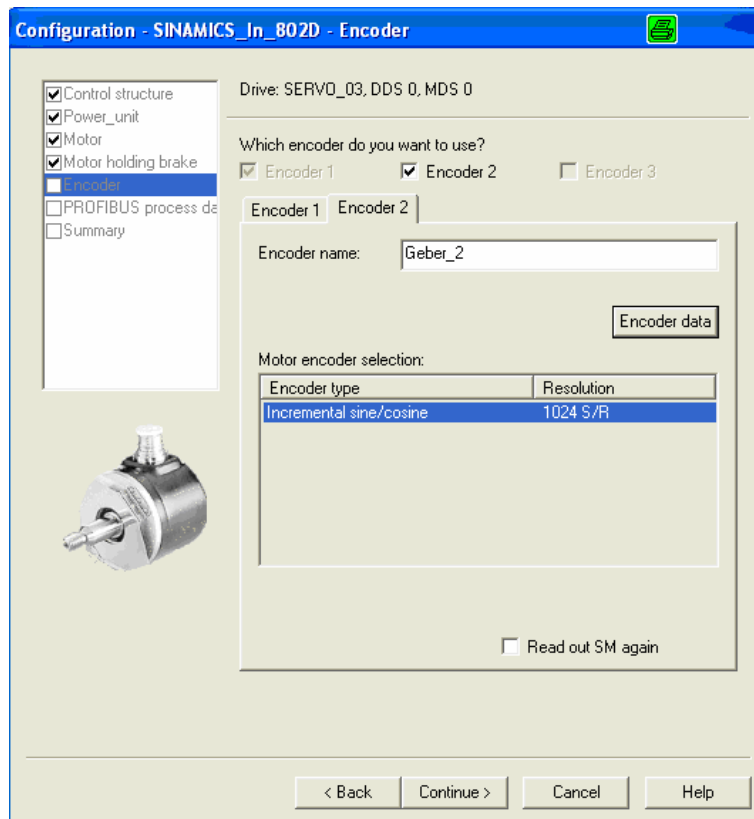

Figure 10-14 Configuration of the encoder

5. In the next step, you must select the message frame type. For this, press **<Continue>**. The system displays the following screen.



Figure 10-15 Setting the message frame type

Note

For the SINUMERIK 802D sl (as of software release 1.1 for G/N or 1.2 for T/M), the message frame 116 is to be set.

6. With **<Continue>**, you can reach the the screen of the BICO interconnection.

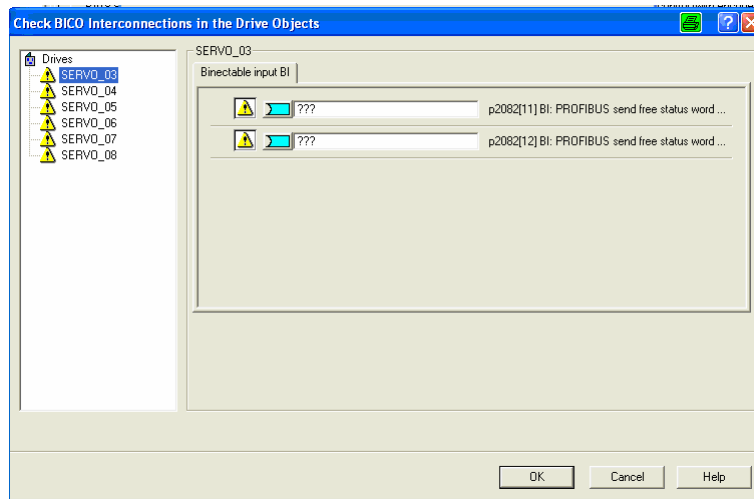

Figure 10-16 BICO interconnection

You can close the screen with **<Cancel>**. Confirm the safety query with **<Yes>**.

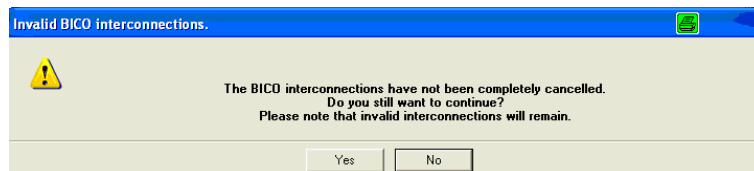

Figure 10-17 Safety query

Thus, the commissioning of the 2nd encoder is completed. To check, activate the topology screen.

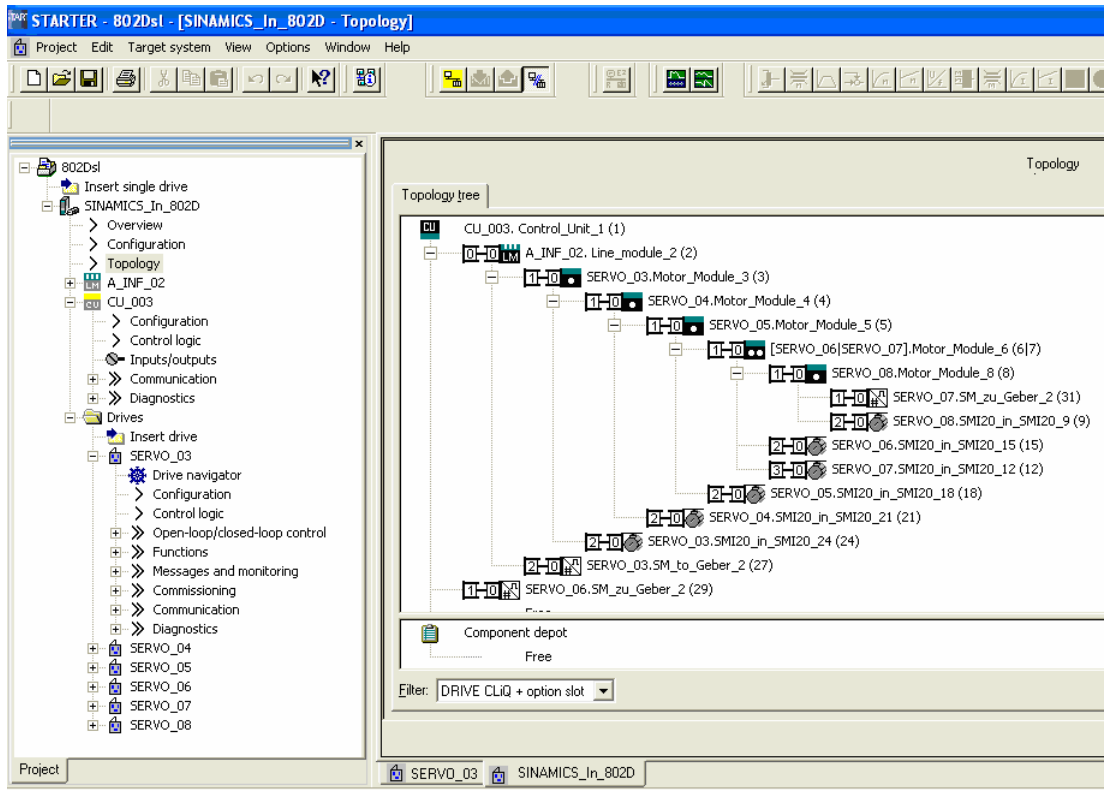

Figure 10-18 Displaying the topology

The direct measuring system of the spindle (Servo_03_to_Geber_2) is connected to the infeed (A_INF_02...).

1. After completing all steps required for the configuration, you must reload the project back into the control system.

Note

The topology window must be closed prior to connecting to the control system.

Establish a connection to the target system.

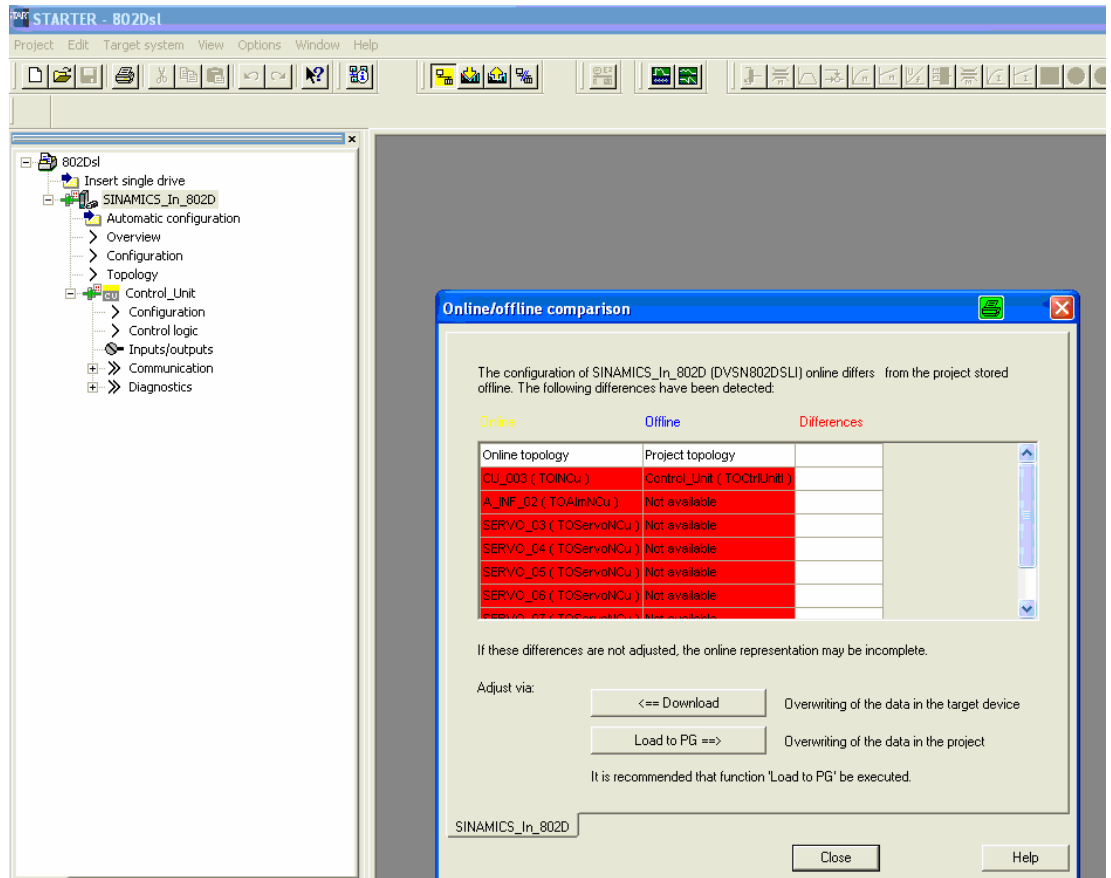

Figure 10-19 Online connection is established

Click the **<== Download** button. The system automatically saves the drive data in the control system. Commissioning has been completed.

10.1.2 Interface settings on PG/PC

PPI interface

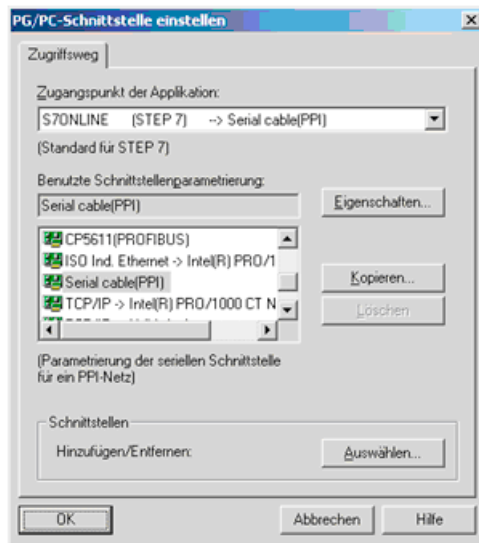

Figure 10-20 Setting up the PG/PC interface: Properties

The system has determined all possible interfaces on your PC (e.g. Serial Cable **(PPI)**). Select an interface via the **Interface parameterization used** list box; thereafter, click on the **Properties** button and adapt the baud rate to the settings in the 802D sl (default: 115.2 kbit/s).

TCP/IP interface

The connection can be established via the TCP/IP protocol. To this end, connect the PC/PG to the CU directly using a X Crosslink patch cable or a standard patch cable via the corporate LAN.

The following additional steps of operation are required here:

- Use the mouse to select the drive unit in the Project Navigator.
- Open the selection menu by clicking on the right mouse button.
- Use "Target device online access" to load data into the interactive dialog box which is now displayed.

Slot 25 and the IP address do not comply with the default configuration.

In corporate networks, the IP address assigned by the administrator must be entered; with direct connection, the SINAMICS is assigned the fixed IP address 169.254.11.22 in 802D.

When establishing a connection via Crosslink, the IP address of the PC/PG (169.254.11.23) must be entered in the user-defined, alternative configuration.

- For corporate networks with DHCP server, the password for protection level 1 must be entered via HMI. Use **System > Service display > Service control system > Service network** to change the DHCP entry to **yes**.

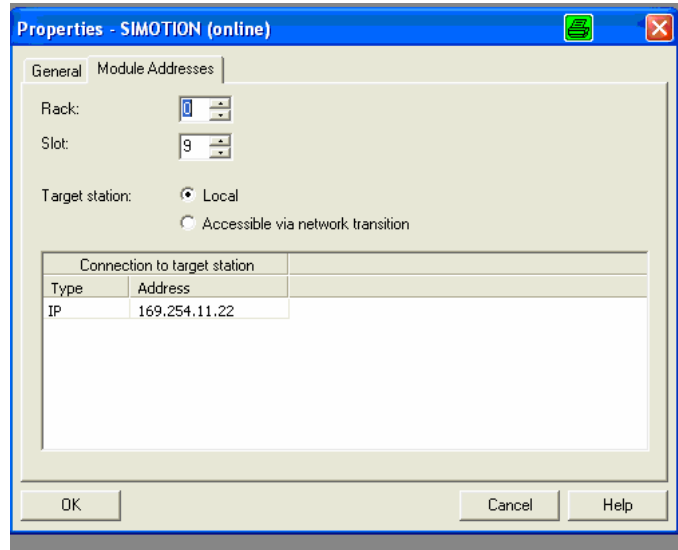

Figure 10-21 Features of SINAMICS

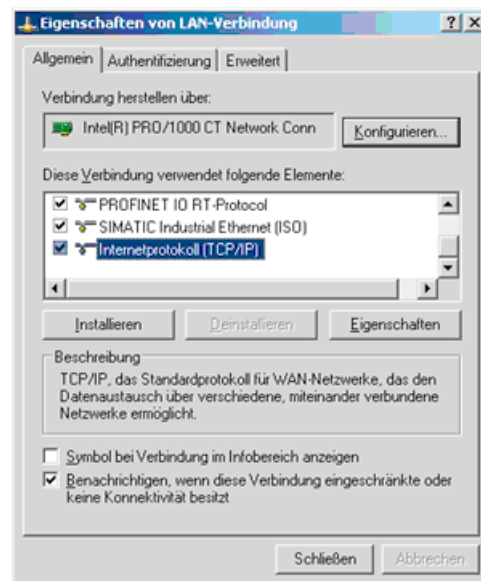

Figure 10-22 Connection properties

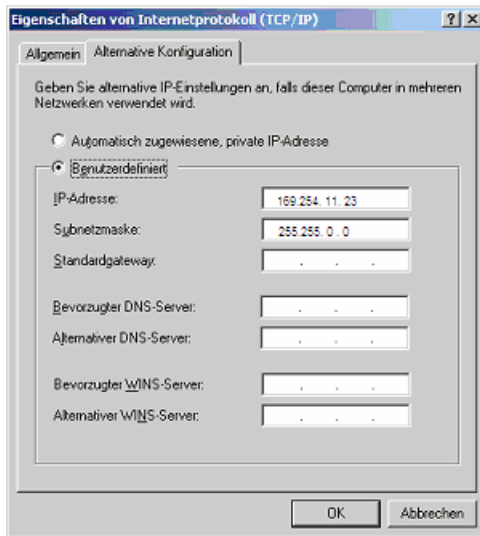

Figure 10-23 Alternative configuration

10.2 Operating the STARTER control panel (motor rotating)

This chapter shows you how to start the motor using the **control panel** function in the STARTER commissioning tool. This includes:

- Load the project into the drive unit.
- Operate the control panel.

Prerequisites

The following prerequisites must be fulfilled to operate the control panel in STARTER:

- The components as described above are assembled.
- The drive unit is turned on as prescribed.
- You have established a connection from the serial PPI interface of the control unit to a PC/PG with PPI interface.
- A project has been created using the STARTER commissioning tool.

10.2.1 Loading the project into the drive unit

To load the project into the drive unit, proceed as follows:

1. Open the project to be loaded using the menu **Project > Open**.
2. To use the "control panel" function, you have to switch to ONLINE mode. To switch to the ONLINE mode, click the function key **Connect to target system** (as shown in Fig. 1-28).

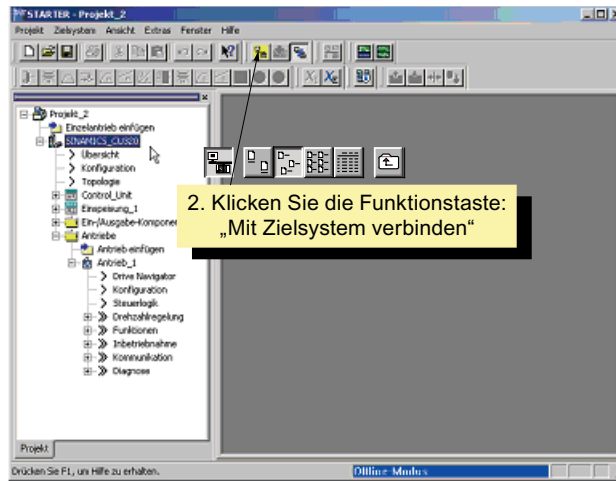

Figure 10-24 Project navigator with SINAMICS_In_802D

3. An ONLINE connection is established and an ONLINE/OFFLINE comparison is carried out. If any differences are found, these are displayed.



Figure 10-25 ONLINE/OFFLINE comparison, loading into target system

4. You changed the data OFFLINE and now have to load it to the target system. Click on the following buttons in sequence:
 - **<-- Download** in the "ONLINE/OFFLINE comparison" dialog box
 - When the system asks "Are you sure?", click **Yes**. The system now starts loading the data.
 - When the system informs you that the data was successfully loaded to the target system, click **OK**.
 - Click **OK** for "Load from RAM to ROM".
5. Differences were detected during the ONLINE/OFFLINE comparison again. Click **Load to PG -->**.



Figure 10-26 ONLINE/OFFLINE comparison, loading into PG

6. Load the new data from the drive unit to the PG. Click on the following buttons in sequence:
 - When the system asks "Are you sure?", click **Yes**. The system now starts loading the data.
 - When the system informs you that the data was successfully loaded into the PG, click **OK**.
7. No further discrepancies are displayed in the ONLINE/OFFLINE comparison dialog box. Click **Close** (see screenshot below).



Figure 10-27 ONLINE/OFFLINE comparison, closing

Note

When loading the project, note the LEDs on the Control Unit. The Control Unit is ready for operation when the LED **RDY** is continuously lit (green).

This completes the procedure for configuring the drive unit hardware.

10.2.2 Operating the control panel

After you have established the connection to the target system and uploaded the project, a green connector symbol is displayed in the Project Navigator in front of the drive unit and the other components configured. This indicates that the project data in STARTER and the target system is consistent (see the following figure).

The drive unit is now ready to operate.

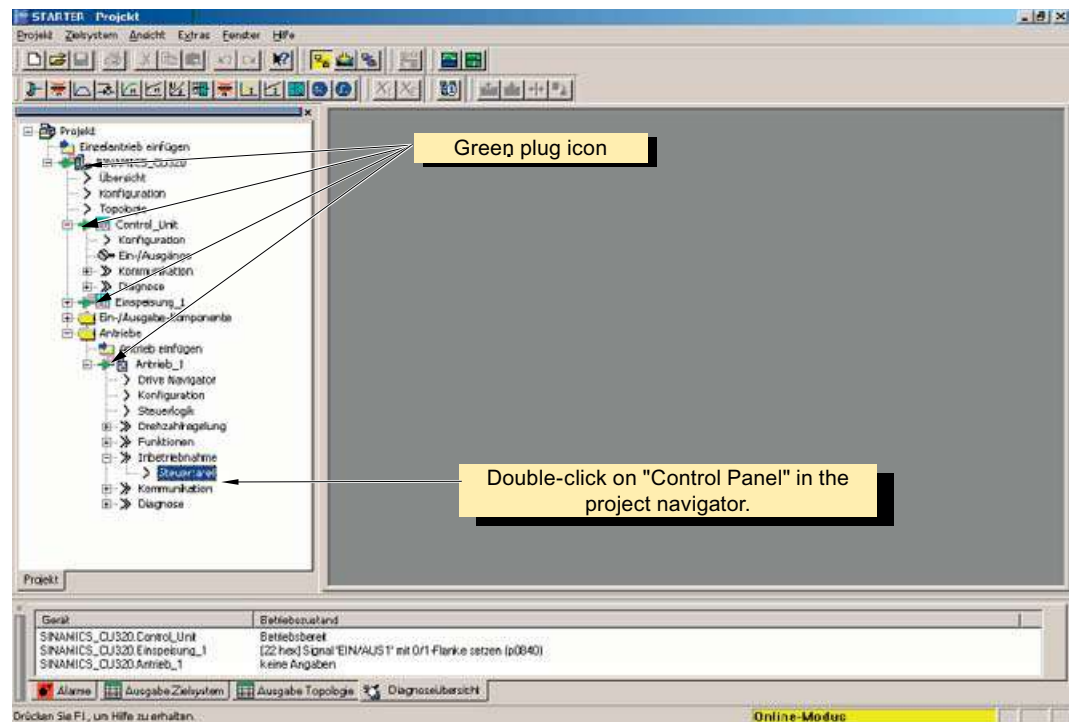

Figure 10-28 Control Panel

The following steps are required to operate the control panel in the STARTER commissioning tool such that the motor rotates:

1. Double-click **control panel** in the project navigator under **Drive_1> Commissioning** (see Fig. 1-32).

The control panel is displayed in STARTER (see the following). You can use the drive control panel to control the drive directly via the PC/PG.

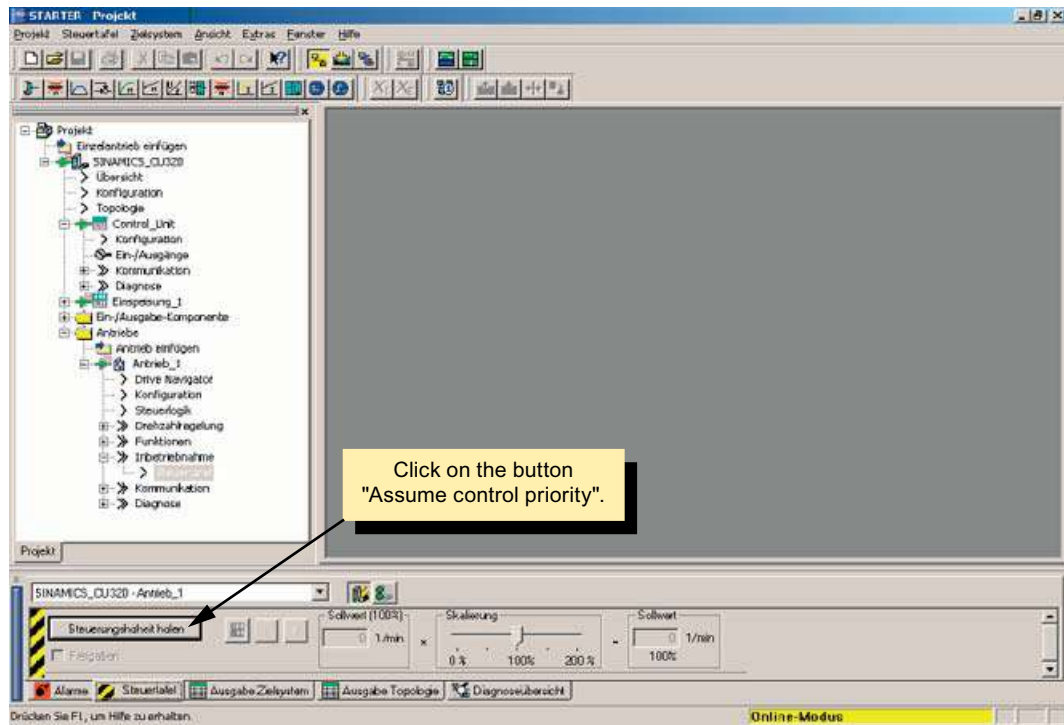

Figure 10-29 Assuming control priority

2. Click **Assume control priority** to connect the control panel to the drive interface.

Note the message that is then displayed in the **Control priority** dialog screen. This message is very important. (also see the following figure).



Danger

Use control priority with care!

This function is intended exclusively for start-up and diagnosis or within the framework of maintenance work.

Make sure that the drive is in the "OFF" status and that no ON/OFF1 command has been issued either by the control word for sequence control or another signal source (e.g. BICO interconnection).

Once control priority has been transferred to the PC, the BICO interconnections on bit 1 to bit 6 of the control word are no longer active.

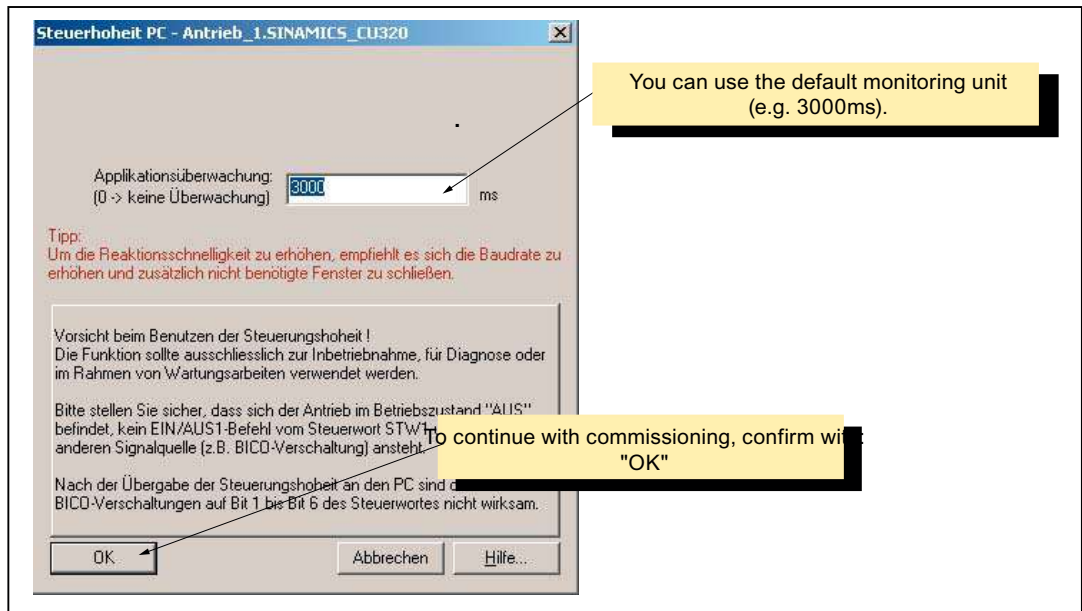

Figure 10-30 Passing on the control priority to the PC

You can enter an application monitoring time, which is the time that elapses between two setpoints before the sign-of-life monitoring function on the drive responds (fault 1910).

You can use the default monitoring time (e.g. 3000 ms).

1. Since our example concerns commissioning, confirm this dialog box for assuming control priority by choosing **OK**.

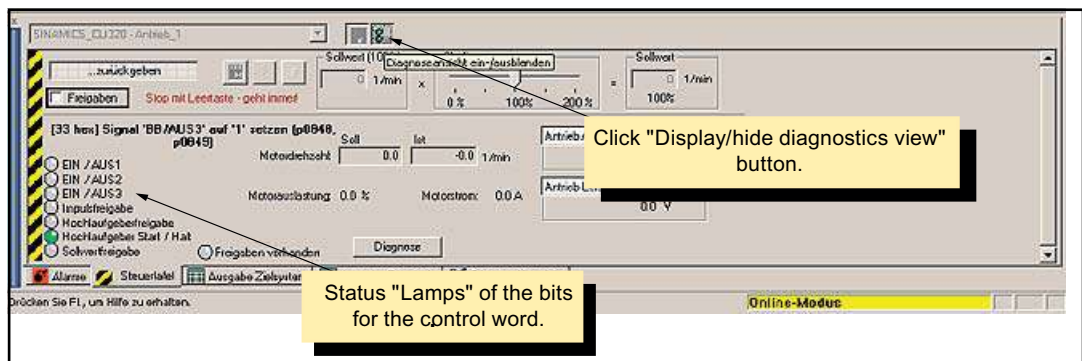

Figure 10-31 Diagnostic view

2. To display, amongst other things, the status lamps for the control word bits, click **Display/hide diagnostics view**.

The following table NO TAG lists the most important digital input signals of the control word for sequence control, which are required to set a motor to motion and which are issued via the control panel for the control unit (CU320 in 802D).

Table 10-1 Control word sequential control

Signal (control panel)	PROFdrive bit no. in CTW sequence control	Meaning
ON/OFF1	Bit 0	0 = OFF (OFF1), stop via ramp-function generator, followed by pulse block 1 = ON, operating condition
ON/OFF2	Bit 1	0 = Coast down (OFF2), pulse block, motor coasts to standstill 1 = Do not coast down, operating condition
ON/OFF3	Bit 2	0 = Rapid stop (OFF3) 1 = No rapid stop, operating condition
Pulse enable	Bit 3	0 = Disable operation, pulse block 1 = Enable operation, enable pulses
Enable ramp-function generator	Bit 4	0 = Set ramp-function generator to 0 1 = Enable ramp-function generator
Start/stop ramp-function generator	Bit 5	0 = Freeze ramp-function generator, retain current output value 1 = Restart ramp-function generator, follows the input value
Setpoint enable	Bit 6	1 = Enable setpoint 0 = Inhibit setpoint and set to 0

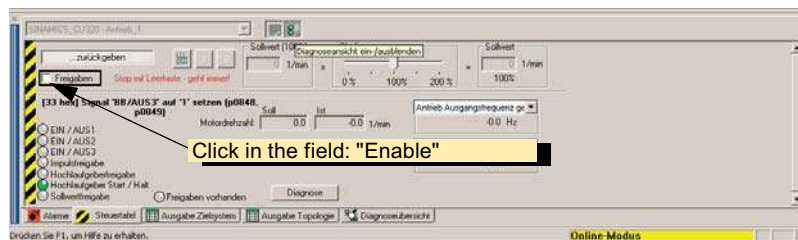

Figure 10-32 Enable

1. Click the **Enables** field to set the commands for enabling the control word in the drive system.

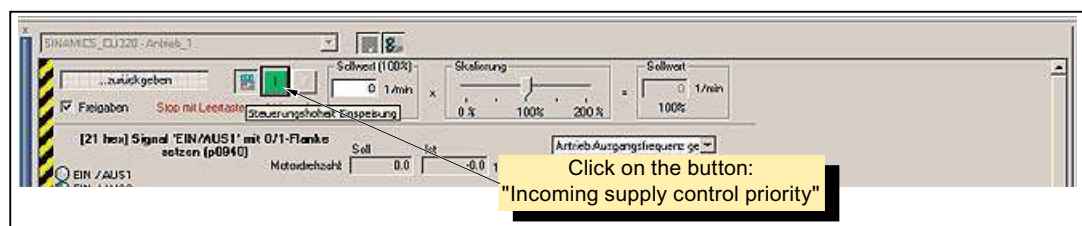

Figure 10-33 Incoming supply control priority

2. Click **Infeed control priority**. The infeed (Active Line Module) is powered-up.

3. Before starting the motor by choosing **Motor on** (see following figure), you have to make the following settings:
 - Enter a speed setpoint (e.g. **50** revolutions per minute).
 - Use the slider to set the setpoint in %. Position your cursor on the slider, hold down the left mouse button, and set the speed to **0%**.



Danger

During commissioning, note the machine traversing range and take appropriate external measures (e.g. monitoring the limit switch).

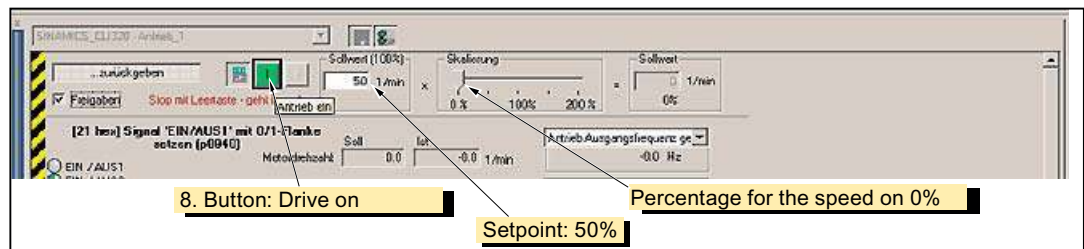

Figure 10-34 Control panel prior to "Drive on"

4. Click the **Drive on** button. The ON/OFF1 enable is set and displayed on the control panel.

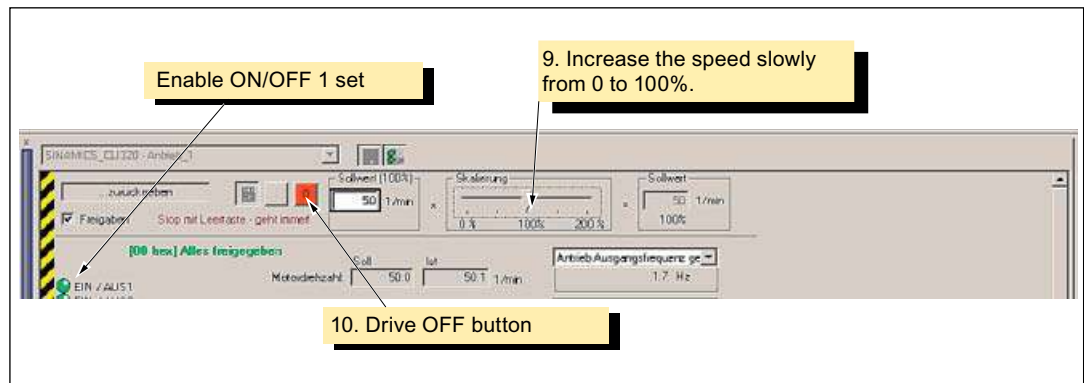

Figure 10-35 motor is turning

5. Move the slider for the speed slowly from 0 to 100%.

The motor starts to rotate.
6. When you click **Stop**, the motor stops. You can also trigger a **fast stop** by pressing the space bar.

The following steps show you how to return control priority to terminate the connection to the drive:

 - Supply
 - Control unit

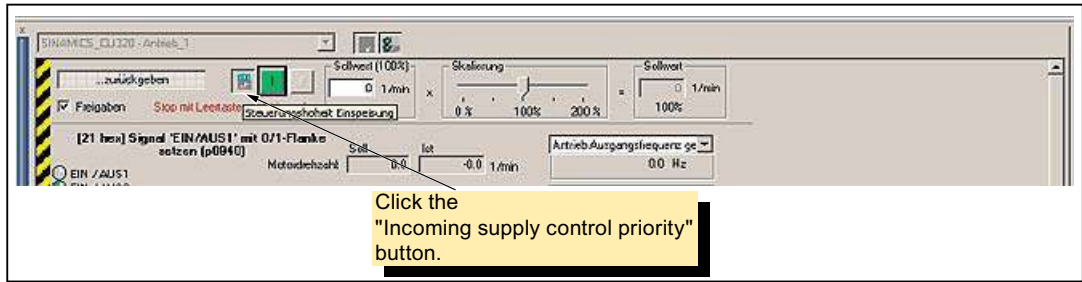

Figure 10-36 Incoming supply control priority

7. Click **Infeed control priority**.

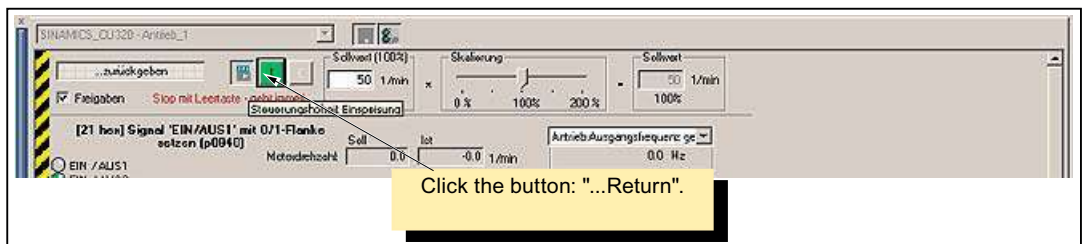

Figure 10-37 Incoming supply control priority

8. Click on the **Return...** button to terminate the connection to the drive unit.



Figure 10-38 Return control priority

9. Confirm the query **Return control priority?** with **Yes**

Now you are in the STARTER commissioning tool project, as shown in the figure below.

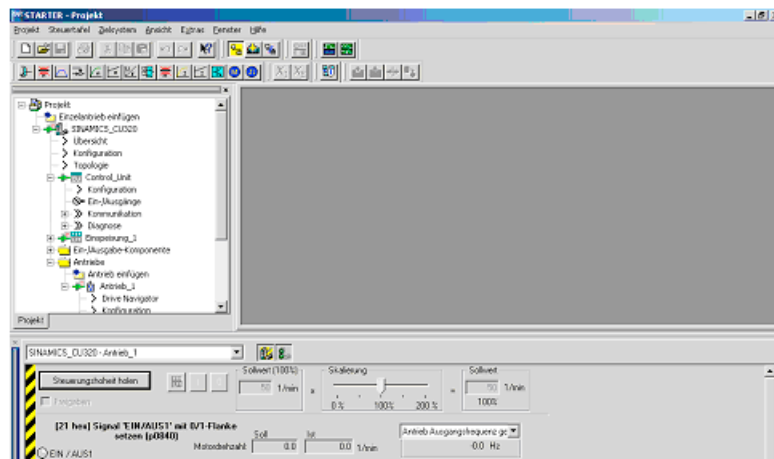

Figure 10-39 Commissioning completed

Starting Up the PLC

11.1 Overview

General information

The PLC is intended to control machine-related functional sequences. It is realized as a software PLC.

The user program - a PLC cycle - is always executed in the same order of sequence.

- Refresh of the process image (inputs, user interface, timers)
- Processing of communication requests (operator panel, PLC 802 programming tool, version 3.0 and higher)
- Editing of the user program
- Evaluation of alarms
- Output of the process image (outputs, user interface)

During the cycle, the PLC executes the user program from the first to the last operation. The user program accesses the hardware inputs/outputs only via the process image and not directly. The PLC refreshes the hardware I/Os at the beginning or end of program execution. Thus, these signals are stable over a whole PLC cycle.

The user program can only be created using the PLC 802 Programming Tool, version 3.1 and higher, with the S7-200 programming language using ladder diagram. Ladder diagram is a graphical programming language for representing electric circuit diagrams.

Note

"PLC 802 Library" with a description, which can be installed from the toolbox CD is offered as the basis for the PLC user program. This library contains a subroutine library and a sample program for a milling machine.

If the Stop and Reset buttons are not implemented as normally closed contacts, a break in the line cannot be detected.

Monitoring can take place via software solutions, as shown in the example MCP_802D (SBR 34) of the subroutine library.

11.2 Programming Tool PLC802

The Programming Tool PLC 802 programming package provides a user-friendly environment for developing, editing, and observing the logic to control your applications.

11.2.1 Selecting the target system

In the Programming Tool PLC802, the CPU type can be selected as the preset. In the operation tree, the operations that cannot be used for the target system, are marked with a red X (✗).

By presetting the CPU type, an error check of the program already takes place when the program is written.

Note

If the CPU type is not preset when opening a new project, all of the operations, addresses and functions in the Programming Tool PLC802 are available and can be used in the program. No check occurs during the input. Errors in presetting the CPU type are only displayed after successful download and restart of the control system.

Procedure

- You are now in the Programming Tool PLC802.
- Select the **Target system > CPU type** from the menu or right click on **Project name (CPU type)** in the operation tree.

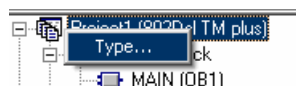

Figure 11-1 Select the CPU type by clicking with the right mouse key

- You select a target system from the list box.

Example: 

Range and functional limitations of the **latest** firmware version of the 802Dsl TM plus are taken into consideration. In order to ensure that both the CPU type and the product version of the firmware are taken into consideration when the range checks are carried out, you can have the Programming Tool PLC802 read the CPU type information directly from the target system. For more information, refer to the Programming Tool PLC802 online help.

- Reading the removed CPU type using the Programming Tool PLC 802

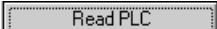
For a read-out of the CPU type and product version of the firmware, click on the button  in the "CPU-Type" dialog box.

The CPU type and the firmware version are displayed in the list box.

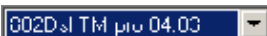

11.2.2 Interface to PLC

Independently of the installed hardware, the following options are available for the connection setup between the control system and the PG/PC:

- Via RS232 cables
The parameters that are preset in the Programming Tool PLC802 must be accepted. No further adaptation is required.
- Optionally via a network (Ethernet)
Communication settings must be adapted in the control system and in the PLC802 programming tool.

You can set up the communication or you can edit the communication settings at any time.

Connection buildup via the RS232 port

The RS232 (V24) port can be used for connecting between the control system and the PC/PG (Programming Tool PLC802).

Activating the connection to the control system

The connection is activated at the operator panel of the control system in the System operating area via the **<PLC> <STEP 7 connect.> softkeys. <Connect. active>** The active or inactive state is kept even after Power On (except power-up with the default data). An active connection is displayed by a symbol in the status bar.

Communication settings in the Programming Tool PLC802

To setup the PPI parameters in the PLC802 programming tool, proceed as follows:

1. In the navigation bar, click on the communication symbol or select View > Communication from the menu.

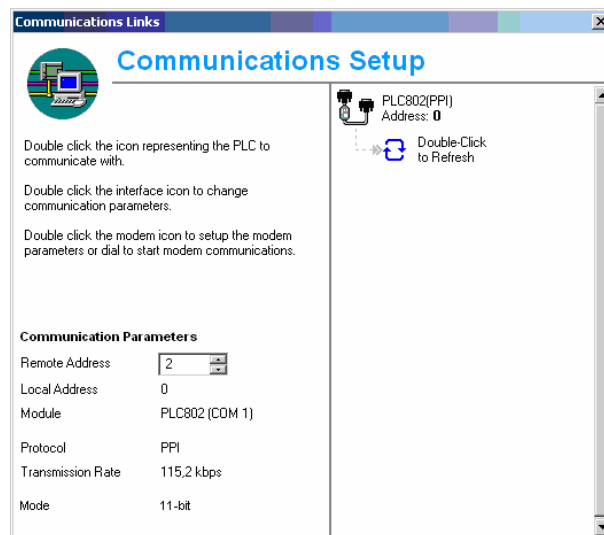

Figure 11-2 Communication settings

2. Double click on the "Access point" symbol in the "Communication" window.

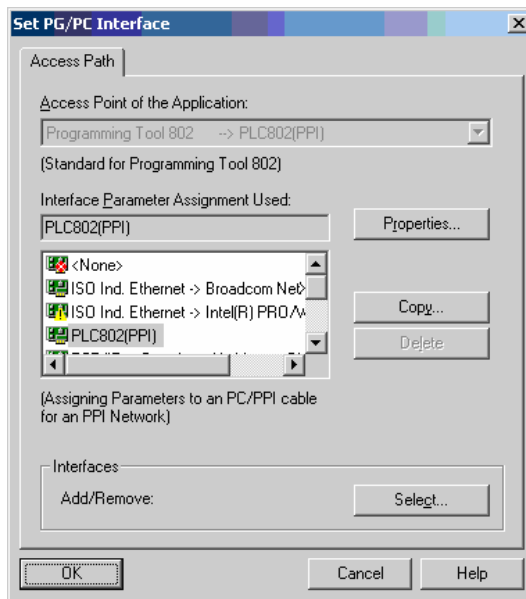

Figure 11-3 Setting the interface

3. Check the PG/PC interface in use. For RS232 communication, the interface 802D(PPI) must be assigned to the PLC802 programming tool.
4. Set the baud rate for the transmission rate, which the Programming Tool PLC802 will use to communicate. The 802D sl supports 9.6 kBaud, 19.2 kBaud, 38.4 kBaud, 57.6 kBaud and 115.2 kBaud.
5. Open the "local connection" tab.

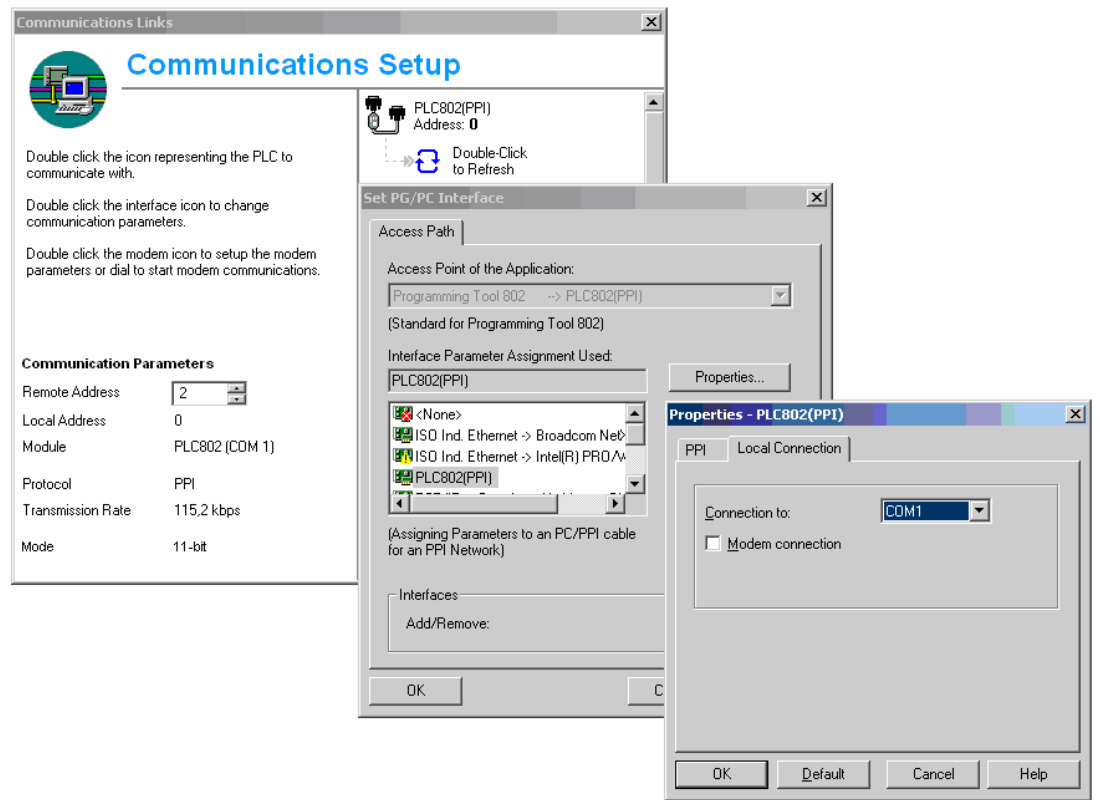

Figure 11-4 Opening the "Local connection" window

6. In the "local connection" tab, specify the COM port to which the RS232 (V24) cable is connected.
7. Click on "OK" to exit the "Set PG/PC interface" dialog box.
8. On the right side of the "Communication" dialog box, click on the blue text "Double-click to refresh".

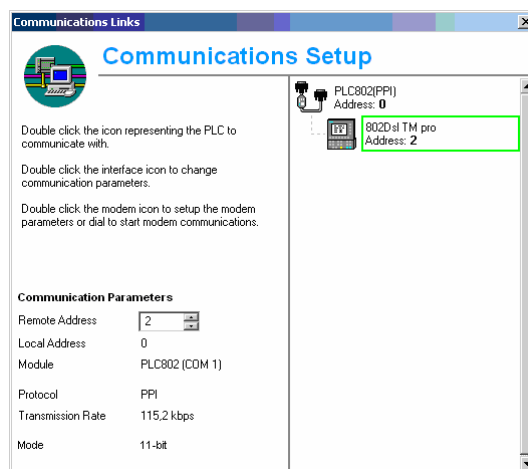

Figure 11-5 Communications link

Note

The connection must be activated at the control system (System > PLC > Connect on).

Connection buildup via Ethernet

The PLC802 programming tool needs port 102 for Ethernet communication.

Enabling a communication port on the control system

Enabling is done on the operator panel of the control system in the System operating area via the softkeys <Service display> <Service control> <Service network> <Service firewall>.

Communication settings in the Programming Tool PLC802

Proceed as follows to setup the network connection:

1. In the navigation bar, click on the communication symbol or select View > Communication from the menu.
2. Double click on the "Access point" symbol in the "Communication" window.

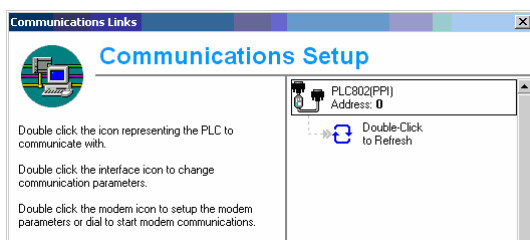

Figure 11-6 Ethernet communication settings

3. Select the Ethernet card for your computer.

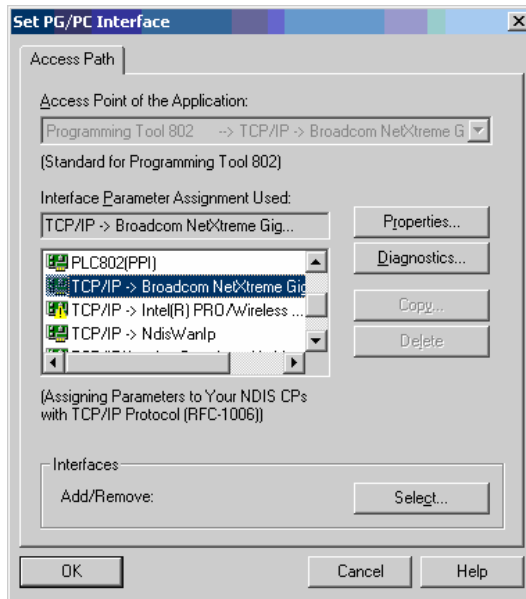

Figure 11-7 Network card settings

1. In the "Set PG/PC interface" dialog box, select the "OK" button.
2. In the "Communication parameter" dialog box, enter the IP address for the corresponding 802Dsl control system.
3. Double-click on the Refresh symbol to establish a connection to the specified IP address.
 - If the connection is established and the type of the target system can be successfully determined, the corresponding symbol of the target system is displayed in the "Communication" dialog box.
 - If the connection attempt fails, the IP address is displayed as "not available" in the "Communication" dialog box.
 - If the connection is established, but STEP 7 Micro/WIN cannot determine the type of target system, the IP address is displayed as "unknown".

Note

The connection must be enabled at the control system (**Port 102**).

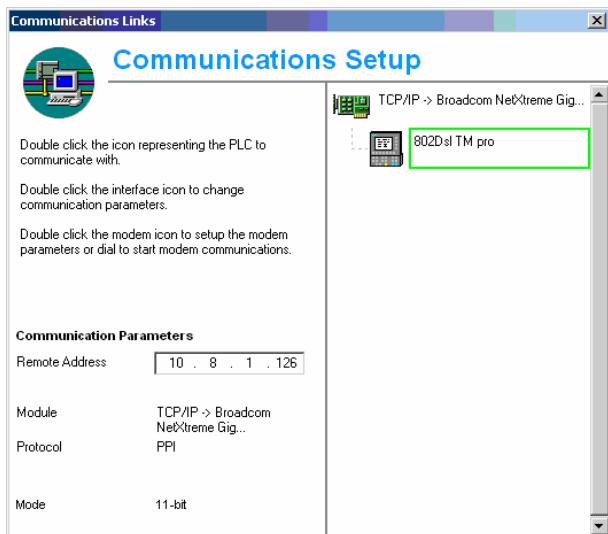

Figure 11-8 Network communication connection

11.3 First commissioning of the PLC

In the delivered condition of the SINUMERIK 802D sl, the user program only consists of a NOP statement (no operation) and is stored in permanent memory. A user program corresponding to the requirements of the machine must be created by the user himself.

11.4 Commissioning modes of the PLC

Table 11-1 Commissioning modes

Selection			Response			
PCU switch on menu (802D sl)	PCU start up menu (802D sl)	PT PLC802 (PC)	PLC program preselection	Program status	Retentive data (supported)	MD for the PLC in the user interface
	NCK Start Up *					
Normal powerup	Normal powerup		User program ***	Run	Unchanged	Accepting the active PLC MD
Power-up with default values	Power-up with default values		User program ***	Run	deleted	Standard PLC MD
Power-up with saved data	Power-up with saved data		User program ***	Run	saved data	Saved PLC MD
PLC - Stop after POWER ON		PLC stop possible in Run or Stop	Unchanged	Stop	Unchanged	Accepting the active PLC MD
PLC clear all / Default PLC program			NOP user program	Run	deleted	Standard PLC MD

Selection			Response			
PCU switch on menu (802D sl)	PCU start up menu (802D sl)	PT PLC802 (PC)	PLC program preselection	Program status	Retentive data (supported)	MD for the PLC in the user interface
	PLC Start Up **					
	Cold restart	Run (after Stop)	User program ***	Run	Unchanged	Accepting the active PLC MD
	Cold restart and debug mode		User program ***	Stop	Unchanged	Accepting the active PLC MD
	CPU memory reset		User program ***	Run	deleted	Accepting the active PLC MD
	CPU memory reset and debug mode		User program ***	Stop	deleted	Accepting the active PLC MD
* Hardkey System / Softkey Start up / NC ** Hardkey System / Softkey Start up / PLC *** loads from the permanent memory into RAM memory						

Via the debug mode, the PLC remains in PLC stop after the control system start up. All startup modes that are set via a softkey only become effective after the next control system start up.

The Run mode activates the cyclic operation.

In the Stop mode, the following actions are activated:

- all HW outputs are disabled
- Profibus-DP is inactive
- no cyclical operation (active user program is not executed)
- The process image is no longer refreshed (frozen)
- EMERGENCY STOP active

The user only has the capability of loading a corrected or new project into the control system in Stop mode. The user program only becomes active after the next start up of the control system or of Run mode.

11.5 PLC alarms

11.5.1 Overview

The control system displays a maximum of 8 PLC alarms (system alarms or user alarms).

The PLC manages the alarm information per PLC cycle. It saves or deletes the alarms in the alarm list in chronological order based on the time of their occurrence. The first alarm in the list is always the last alarm that occurred.

When there are more than 8 alarms, the first seven alarms that occurred and the last (chronologically) are displayed with the highest deletion priority.

Alarm response and cancel criteria

The PLC also manages the alarm responses. The alarm reactions are always in effect regardless of the number of active alarms. Depending on the type of alarm response, the PLC activates the necessary action.

A cancel criterion must be defined for each alarm. By default, the PLC uses the cancel criterion SELF-CLEARING (see configuration of user alarms).

The following are cancel criteria:

- POWERONCLEAR: The alarm is canceled by turning off / turning on the control system (POWER ON).
- CANCELCLEAR: The alarm is cancelled by pressing the Cancel key or Reset key (analog NCK - alarms).
- SELF-CLEARING: The alarm is cleared by the no longer existent cause of the alarm.

The clearing conditions have the following priority:

- POWERON CLEAR - system alarms (highest priority)
- CANCEL CLEAR - system alarms
- SELF-CLEARING - system alarms
- POWERON CLEAR - user alarms
- CANCEL CLEAR - system alarms
- SELF-CLEARING - user alarm (lowest priority)

The responses that an alarm is supposed to trigger in the PLC are defined for each alarm. By default, the PLC uses the alarm response SHOWALARM.

The following are alarm responses:

- PLC - Stop : No further user programs are executed, Profibus DP inactive and disabling of the hardware outputs.
- EMERGENCY STOP: The PLC reports the EMER STOP signal to the NCK after processing the user program in the user interface.

- Feed disable: The PLC reports the FEED DISABLE signal to the NCK after processing the user program in the user interface.
- Read-in disable: The PLC reports the READ-IN DISABLE signal to the NCK after processing the user program in the user interface.
- NC Start disable: The PLC reports the NC START DISABLE signal to the NCK after processing the user program in the user interface.
- SHOWALARM : This alarm has no alarm response.

11.5.2 General PLC alarms

Note

see SINUMERIK 802D sl diagnostics guide

11.5.3 User alarms

The subareas (0, 1) are available to the user in the user interface " 1600xxxx " for defining a user alarm.

- Subarea 0: 8 x 8 bits for setting the user alarms (0 ->1 edge)
 - byte 0 : Bit 0 => 1. user alarm " 700000 "
 - byte 1 : Bit 0 => 9. user alarm " 700008 "
 - byte 7 : Bit 7 => 64. user alarm " 700063 "

A new user alarm is activated with the respective bit (subarea 0) with a 0/1 edge.

- Subarea 1: Variables of the user alarms

Subarea 1 is provided for additional user information. It can only be written or read as a double word.

- Subarea 2: Alarm response
 - Byte 0 : Bit 0 => NC Start disable
 - Bit 1 => reading-in disable
 - Bit 2 => feed disable of all axes
 - Bit 3 => EMER STOP
 - Bit 4 => PLC STOP

With the aid of subarea 2, the user can evaluate the active alarm responses. It is read-only.

The user must clear self-clearing user alarms by resetting the respective bit in subarea 0 (1 -> 0 edge).

For the other user alarms, the PLC clears the corresponding user alarms after detecting the corresponding clearing conditions. If the bit of the user alarm is still on, the alarm reappears.

Method of operation of a user alarm

A user alarm has a higher priority than the corresponding signal in the user interface (e.g. NC Start disable, read-in disable and EMER stop).

Example:

MD 14516[0]: USER_DAT_PLC_ALARM = 8

For the active alarm 700000, the alarm 3000 EMER Stop is also active although the interface signal V26000000.1=0

Configuring user alarms

A configuration byte exists for each alarm. The user alarms can be configured by the user in the machine data **14516: USER_DATA_PLC_ALARM**.

Default setting MD 14516[0...63]: 0 => SHOWALARM/SELF-CLEARING user alarm

Setup of the configuration byte:

- Bit0 - Bit5 : Alarm responses
- Bit6 - Bit7 : Clearing criterion

Alarm responses: Bit0 - Bit 5 = 0: Showalarm (default)

Bit0 = 1: NC Start disable

Bit1 = 1: Read-in disable

Bit2 = 1: Feed disable of all axes

Bit3 = 1: EMER Stop

Bit4 = 1: PLC Stop

Bit5 = reserved

Cancel criteria: Bit6 + Bit7 = 0: SELF-CLEARING alarm (default)

Bit6 = 1 : CANCELCLEAR alarm

Bit7 = 1 : POWERONCLEAR alarm

The user alarm response PLC-Stop always has the clearing condition POWER ON.

Alarm texts

The user has two options for defining his own alarm texts.

- via hardkey **System \ Softkey <PLC> <Process PLC Alarm txt>**
- via Toolbox: Editing and loading the alarm text file with the aid of the RCS802 tool

If the user does not assign a user alarm text, only the alarm number is displayed.

The % symbol in the alarm text designates an additional variable. The variable type represents the display form of the variable.

These variable types are possible:

- %D whole decimal numbers
- % I whole decimal numbers
- %U Decimal number without sign
- %O whole octal number
- %X whole hexadecimal number
- %B binary representation of 32 bit value

- %F 4 byte floating point number

Examples - user alarm texts (Note: The text after "/" is a comment and is not displayed.)

- 700000 " " // only user alarm number
- 700001 " HW limit switch axis X +"
- 700002 " %D " // only variable as a whole decimal number
- 700003 " Alarm number with fixed alarm text and variable %X "
- 700004 " %U Alarm number with variable and fixed alarm text "
- 700005 "Monitoring of axis active : %U"

Display: 700005 "Monitoring of axis active : 1
or 700005 monitoring of axis active : 3

11.6 PLC Programming

11.6.1 Overview

The PLC user program is created with the aid of the PLC 802 programming tool.

In the "SIMATIC S7-200 Automation System System Manual" documentation, you will find the handling instructions for an S7-200. The PLC 802 programming tool implements a subset of this documentation.

The following must be observed as compared to the basic S7-200 MicroWin system:

- It is only possible to program the user program in a ladder diagram.
- Only a subset of the programming language for the S7-200 is supported.
- The compilation of the user program is done offline on a PG/PC or automatically during the download into the control system.
- The project can be loaded into the control system (download).
- It is possible to load the project from the control system (download).
- No indirect addressing of the data is possible. Therefore, there are no programming errors in this respect while the program is running.
- The user must manage his data and process information by type.
For all accesses to the data, the agreed data type must be consistently used.

How Do I

Information 1 T-value memory size DInt (32 Bit)
Information 2 Override memory size byte (8 Bit)

User data

memory double word MD0 DInt (Information 1)
memory byte MB4 byte (Information 2)

- Furthermore, the alignment of the data to certain memory addresses is dependent upon the type of data (alignment). The alignment is done to byte addresses, which can be divided by the byte length of the data type with no remainder.

BOOL and BYTE can begin at any byte address (0, 1, 2, 3, ...),
 WORD and INT must begin at an even byte address (0, 2, 4, 6, ...) and
 DWORD, DINT and REAL must begin at a byte address that is divisible by 4 (0, 4, 8, 12, ...).

How Do I

Memory bit MB0.1,MB3.5
 memory byte MB0,MB1,MB2
 memory word MW0,MW2,MW4
MW3, MW5 ... are not permitted
 memory double word MD0,MD4,MD8
MD1,MD2,MD3, MD5 ... are not permitted

Table 11-2 PLC data types permitted in the control system

Data type	Size	Address alignment	Range for logical Operations	Range for arithmetical Operations
BOOL	1 bit	1	0, 1	-
BYTE	1 bytes	1	00 ... FF	0 ... +255
WORD	2 bytes	2	0000 ... FFFF	-32 768 ... + 32 767
DWORD (Double Word)	4 bytes	4	0000 0000 ... FFFF FFFF	-2 147 483 648 ... +2 147 483 647
REAL	4 bytes	4	-	$\pm 10^{-37} \dots \pm 10^{38}$

PLC project

The PLC 802 programming tool always manages a project (combinational logic, symbols and comments). By downloading, it is possible to save all of the essential information of a project in the control system. By uploading, the information is transferred from the control system to the PC.

The control system can save a maximum of 6,000 instructional commands (4,000 for 802D sl value) and 1,500 symbols. The needed PLC memory is influenced by the following components:

- Number of statements
- Number and length of the symbol names
- Number and length of the comments

S7-200 Ladder diagram

The addresses and operations can be defined in the "International" display mode. In the ladder diagram, the user programs his program in networks. Each network corresponds to a logic that reflects a certain sequence. In a ladder diagram, contacts, coils and boxes are possible as basic elements. For the contacts, there are normally open and normally closed contacts. Each coil corresponds to a relay. A box reflects a certain function. A box can be activated using an enable bit.

11.6.2 Overview of commands

Table 11-3 Operand identifier

Operand identifier	Description
V	data
T	Times
C	Meters
I	Image of digital inputs
Q	Image of digital outputs
F	Flag
SM	Special bit memory
AC	ACCU
L	Local data

Table 11-4 Structure of V-range addresses (see user interface)

Type ID (module no.)	Range no. (channel and axis No.)	Subarea	Offset	Addressing
00 (10-79)	00 (00-99)	0 (0-9)	000 (000-999)	Symbolic (8-digit)

Table 11-5 802D sl address ranges

Access	Storage method	802Dsl TM value	802Dsl TM plus 802Dsl NG plus	802Dsl TM pro 802Dsl NG pro 802Dsl CU pro
Bit (Byte.bit)	V	14000000.0-79999999.7	14000000.0-79999999.7	14000000.0-79999999.7
	I	0.0 – 26.7	0.0 – 26.7	0.0 – 26.7
	Q	0.0 – 17.7	0.0 – 17.7	0.0 – 17.7
	F	0.0 – 255.7	0.0 – 383.7	0.0 – 383.7
	SM	0.0 - 0.6	0.0 - 0.6	0.0 - 0.6
	T	0-15 (100ms) 16-39 (10ms)	0-15 (100ms) 16-39 (10ms)	0-15 (100ms) 16-63 (10ms)
	C	0 – 31	0 – 31	0 – 63
	L	0.0 - 59.7	0.0 - 59.7	0.0 - 59.7

Access	Storage method	802Dsl TM value	802Dsl TM plus 802Dsl NG plus	802Dsl TM pro 802Dsl NG pro 802Dsl CU pro
Byte	VB	14000000-79999999	14000000-79999999	14000000-79999999
	IB	0 – 26	0 – 26	0 – 26
	QB	0 – 17	0 – 17	0 – 17
	MB	0 – 255	0 – 383	0 – 383
	SMB	0	0	0
	LB	0 – 59	0 – 59	0 – 59
	AC	0 – 3	0 – 3	0 – 3
Word	VW	14000000-79999998	14000000-79999998	14000000-79999998
	IW	0 – 24	0 – 24	0 – 24
	QW	0 – 16	0 – 16	0 – 16
	MW	0 – 254	0 – 382	0 – 382
	T	0–15 (100ms) 16–39 (10ms)	0–15 (100ms) 16–39 (10ms)	0–15 (100ms) 16–63 (10ms)
	C	0 – 31	0 – 31	0 – 63
	LW	0 – 58	0 – 58	0 – 58
	AC	0 – 3	0 – 3	0 – 3
Double word	VD	14000000-79999994	14000000-79999994	14000000-79999994
	ID	0 – 20	0 – 20	0 – 20
	QD	0 – 12	0 – 12	0 – 12
	MD	0 – 252	0 – 380	0 – 380
	LD	0 – 56	0 – 56	0 – 56
	AC	0 – 3	0 – 3	0 – 3

Table 11-6 Special Marker SM Bit Definition

SM bits	Description
SM 0.0	Bit memory with defined ONE signal
SM 0.1	Initial setting: first PLC cycle '1', subsequent cycles '0'
SM 0.2	buffered data lost - only valid in first PLC cycle ('0' data ok, '1' data lost)
SM 0.3	POWER ON: first PLC cycle '1', subsequent cycles '0'
SM 0.4	60 s clock (alternating '0' for 30 s, then '1' for 30 s)
SM 0.5	1 s clock (alternating '0' for 0.5 s, then '1' for 0.5 s)
SM 0.6	PLC cycle clock (alternating one cycle '0', then one cycle '1')

The user can only view the statement list (STL) in the PT802 in "View STL". In this display method (see table: mnemonic), the sequential processing is displayed.

11.6.3 Explanation of the stack operations

Table 11-7 BASIC BOOLEAN INSTRUCTIONS

BASIC BOOLEAN INSTRUCTIONS		
Instruction	Ladder Symbol	Valid Operands
Load And Or	normal open n=1 close n=0 open 	n: V, I, Q, M, SM, T, C, L
Load Not And Not Or Not	normal close n=0 close n=1 open 	n: V, I, Q, M, SM, T, C, L
Output	prior 0, n=0 prior 1, n=1 	n: V, I, Q, M, T, C, L
Set (1 Bit)	prior 0, not set prior 1 or ↗ 	S_Bit: V, I, Q, M, T, C, L n = 1
Reset (1 Bit)	prior 0, no reset prior 1 or ↗ 	S_Bit: V, I, Q, M, T, C, L n = 1

Table 11-8 OTHER BOOLEAN INSTRUCTIONS



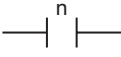
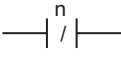
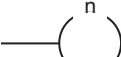
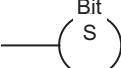
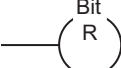

OTHER BOOLEAN INSTRUCTIONS		
Instruction	Ladder Symbol	Valid Operands
Edge Up	prior ↗ close (1 PLC cycle) 	
Edge Down	prior ↗ close (1 PLC cycle) 	
Logical Not	prior 0, later 1 prior 1, later 0 	
No operation		n = 0 ... 255

Table 11-9 BYTE COMPARES

BYTE COMPARES (Unsigned)		
Instruction	Ladder Symbol	Valid Operands
Load Byte = And Byte = Or Byte =	a = b close a ≠ b open 	a : VB, IB, QB, MB, SMB, AC, Constant, LB b: VB, IB, QB, MB, SMB, AC, Constant, LB

BYTE COMPARES (Unsigned)		
Instruction	Ladder Symbol	Valid Operands
Load Byte ≥ And Byte ≥ Or Byte ≥	a ≥ b close a < b open 	
Load Byte ≤ And Byte ≤ Or Byte ≤	a ≤ b close a > b open 	
Load Byte ≠ And Byte ≠ Or Byte ≠	a ≠ b close a = b open 	
Load Byte > And Byte > Or Byte >	a > b close a ≤ b open 	
Load Byte < And Byte < Or Byte <	a < b close a ≥ b open 	

Table 11-10 WORD COMPARES

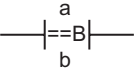
WORD COMPARES (Signed)		
Instruction	Ladder Symbol	Valid Operands
Load Word = And Word = Or Word =	a = b close a ≠ b open 	a : VW, T, C, IW, QW, MW, AC, Constant, LW b: VW, T, C, IW, QW, MW, AC, Constant, LW
Load Word ≥ And Word ≥ Or Word ≥	a ≥ b close a < b open 	
Load Word ≤ And Word ≤ Or Word ≤	a ≤ b close a > b open 	
Load Word ≠ And Word ≠ Or Word ≠	a ≠ b close a = b open 	
Load Word > And Word > Or Word >	a > b close a ≤ b open 	
Load Word < And Word < Or Word <	a < b close a ≥ b open 	

Table 11-11 DOUBLE WORD COMPARES

DOUBLE WORD COMPARES (Signed)		
Instruction	Ladder Symbol	Valid Operands
Load DWord = And DWord = Or DWord =		a : VD, ID, QD, MD, AC, Constant, LB b: VD, ID, QD, MD, AC, Constant, LB
Load DWord ≥ And DWord ≥ Or DWord ≥		
Load DWord ≤ And DWord ≤ Or DWord ≤		
Load DWord ≠ And DWord ≠ Or DWord ≠		
Load DWord > And DWord > Or DWord >		
Load DWord < And DWord < Or DWord <		

Table 11-12 REAL WORD COMPARES

REAL WORD COMPARES (Signed)		
Instruction	Ladder Symbol	Valid Operands
Load RWord = And RWord = Or RWord =		a : VD, ID, QD, MD, AC, Constant, LD b: VD, ID, QD, MD, AC, Constant, LD
Load RWord ≥ And RWord ≥ Or RWord ≥		
Load RWord ≤ And RWord ≤ Or RWord ≤		
Load RWord ≠ And RWord ≠ Or RWord ≠		

REAL WORD COMPARES (Signed)		
Instruction	Ladder Symbol	Valid Operands
Load RWord > And RWord > Or RWord >	$\begin{array}{c} a \\ \text{---} > R \text{---} \\ b \end{array}$	
Load RWord < And RWord < Or RWord <	$\begin{array}{c} a \\ \text{---} < R \text{---} \\ b \end{array}$	

Table 11-13 TIMER

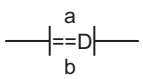
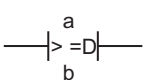
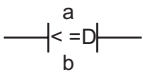
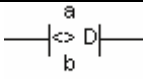
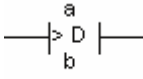
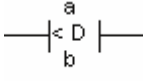
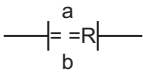
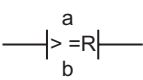
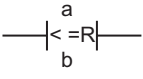
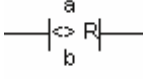
TIMER		
Instruction	Ladder Symbol	Valid Operands
Timer Retentive On Delay EN=1, Start EN=0, Stop If $T_{Value} \geq PT$, $T_{bit}=1$	$\begin{array}{c} Txxx \\ \text{TONR} \\ \text{---} \text{IN} \\ \text{---} \text{PT} \end{array}$	Enable : (IN) S0 Txxx: T0 - T63 (dependent on type of control system) Preset: (PT) VW, T, C, IW, QW, MW, AC, Constant 100 ms T0 - T15 10 ms T16 - T63
Timer On Delay EN=1, Start EN=0, Stop If $T_{Value} \geq PT$, $T_{bit}=1$	$\begin{array}{c} Txxx \\ \text{TON} \\ \text{---} \text{IN} \\ \text{---} \text{PT} \end{array}$	Enable : (IN) S0 Txxx: T0 - T63 Preset: (PT) VW, T, C, IW, QW, MW, AC, Constant 100 ms T0 - T15 10 ms T16 - T63
Timer Of Delay If $T_{Value} < PT$, $T_{bit}=1$	$\begin{array}{c} Txxx \\ \text{TOF} \\ \text{---} \text{IN} \\ \text{---} \text{PT} \end{array}$	Enable : (IN) S0 Txxx: T0 - T63 Preset: (PT) VW, T, C, IW, QW, MW, AC, Constant 100 ms T0 - T15 10 ms T16 - T63

Table 11-14 COUNTER

COUNTER		
Instruction	Ladder Symbol	Valid Operands
Count Up CU ↗, Value+1 R=1, Reset If $C_{Value} \geq PV$, $C_{bit}=1$	$\begin{array}{c} Cxxx \\ \text{---} \text{CU CTU} \\ \text{---} \text{R} \\ \text{---} \text{PV} \end{array}$	Cnt Up: (CU) S1 Reset: (R) S0 Cxxx: C0 - 63 Preset: (PV) VW, T, C, IW, QW, MW, AC, Constant, LW

COUNTER			
Instruction		Ladder Symbol	Valid Operands
Count Up/Down	CU ↑, Value+1 CD ↓, Value-1 R=1, Reset If C _{Value} ≥ PV, C _{bit} =1		Cnt Up: (CU) S2 Cnt Dn: (CD) S1 Reset: (R) S0 Cxxx: C0 - 63 Preset: (PV) VW, T, C, IW, QW, MW, AC, Constant, LW
Count Down	If C _{Value} = 0, C _{bit} =1		Cnt Down: (CD) S2 Reset: (R) S0 Cxxx: C0 - 63 Preset: (PV) VW, T, C, IW, QW, MW, AC, Constant, LW

Table 11-15 MATH OPERATIONS

MATH OPERATIONS			
Instruction		Ladder Symbol	Valid Operands
Word Add Word Subtract	If EN = 1, b = a + b b = b - a		Enable : EN In: VW, T, C, IW, QW, MW, AC, Constant, LW Out: VW, T, C, IW, QW, MW, AC, LW
DWord Add DWord Subtract	If EN = 1, b = a + b b = b - a		Enable : EN In: VD, ID, QD, MD, AC, Constant, LD Out: VD, ID, QD, MD, AC, LD
Multiply	If EN = 1, b = a x b		Enable : EN In: VW, T, C, IW, QW, MW, AC, Constant, LW Out: VD, ID, QD, MD, AC, LD
Divide	If EN = 1, b = b ÷ a Out: 16 bit remainder Out+2: 16 bit quotient		Enable : EN In: VW, T, C, IW, QW, MW, AC, Constant, LW Out: VD, ID, QD, MD, LD
Add Subtract Real Numbers	If EN = 1, b = a + b b = b - a		Enable : EN In: VD, ID, QD, MD, AC, Constant, LD Out: VD, ID, QD, MD, AC, LD

MATH OPERATIONS			
Instruction		Ladder Symbol	Valid Operands
Multiply Divide Real Numbers	If EN = 1, $b = a \times b$ $b = b \div a$	<div style="border: 1px solid black; padding: 5px; width: fit-content; margin: auto;"> MUL_R — EN ENO — — IN1 — — IN2 OUT — </div>	Enable : EN In: VD, ID, QD, MD, AC, Constant, LD Out: VD, ID, QD, MD, AC, LD
Square Root	If EN = 1, OUT = \sqrt{IN}	<div style="border: 1px solid black; padding: 5px; width: fit-content; margin: auto;"> SQR_T — EN ENO — — IN OUT — </div>	Enable : EN In: VD, ID, QD, MD, AC, Constant, LD Out: VD, ID, QD, MD, AC, LD

Table 11-16 INCREMENT, DECREMENT

INCREMENT, DECREMENT			
Instruction		Ladder Symbol	Valid Operands
Increment Decrement Byte	If EN = 1, $a = a + 1$ $a = a - 1$	<div style="border: 1px solid black; padding: 5px; width: fit-content; margin: auto;"> INC_B — EN ENO — — IN OUT — </div>	Enable : EN In: VB, IB, QB, MB, AC, Constant LB Out: VB, IB, QB, MB, AC, LB
Increment Decrement Word	If EN = 1, $a = a + 1$ $a = a - 1$ $a = /a$	<div style="border: 1px solid black; padding: 5px; width: fit-content; margin: auto;"> INC_W — EN ENO — — IN OUT — </div>	Enable : EN In: VW, T, C, IW, QW, MW, AC, Constant, LW Out: VW, T, C, IW, QW, MW, AC, LW
Increment Decrement.	If EN = 1, $a = a + 1$ $a = a - 1$	<div style="border: 1px solid black; padding: 5px; width: fit-content; margin: auto;"> INV_DW — EN ENO — — IN OUT — </div>	Enable : EN In: VD, ID, QD, MD, AC, Constant, LD Out: VD, ID, QD, MD, AC, LD

Table 11-17 LOGIC OPERATIONS

LOGIC OPERATIONS			
Instruction		Ladder Symbol	Valid Operands
Byte AND Byte OR Byte XOR	If EN = 1, $b = a \text{ AND } b$ $b = a \text{ OR } b$ $b = a \text{ XOR } b$	<div style="border: 1px solid black; padding: 5px; width: fit-content; margin: auto;"> WAND_B — EN ENO — — IN1 — — IN2 OUT — </div>	Enable : EN In: VB, IB, QB, MB, AC, Constant, LB Out: VB, IB, QB, MB, AC, LB
Word AND Word OR Word XOR	If EN = 1, $b = a \text{ AND } b$ $b = a \text{ OR } b$ $b = a \text{ XOR } b$	<div style="border: 1px solid black; padding: 5px; width: fit-content; margin: auto;"> WAND_W — EN ENO — — IN1 — — IN2 OUT — </div>	Enable : EN In: VW, T, C, IW, QW, MW, AC, Constant, LW Out: VW, T, C, IW, QW, MW, AC, LW
DWord AND DWord OR DWord XOR	If EN = 1, $b = a \text{ AND } b$ $b = a \text{ OR } b$ $b = a \text{ XOR } b$	<div style="border: 1px solid black; padding: 5px; width: fit-content; margin: auto;"> WXOR_DW — EN ENO — — IN1 — — IN2 OUT — </div>	Enable : EN In: VD, ID, QD, MD, AC, Constant, LD Out: VD, ID, QD, MD, AC, LD

LOGIC OPERATIONS			
Instruction		Ladder Symbol	Valid Operands
Invert Byte	If EN = 1, a = /a		Enable : EN In: VB, IB, QB, MB, AC, Constant, LB Out: VB, IB, QB, MB, AC, LB
Invert Word	If EN = 1, a = /a		Enable : EN In: VW, T, C, IW, QW, MW, AC, Constant, LW Out: VW, T, C, IW, QW, MW, AC, LW
Invert DWord	If EN = 1, a = /a		Enable : EN In: VD, ID, QD, MD, AC, Constant, LD Out: VD, ID, QD, MD, AC, LD

Table 11-18 SHIFT AND ROTATE OPERATIONS

SHIFT AND ROTATE OPERATIONS			
Instruction		Ladder Symbol	Valid Operands
Shift Right Shift Left	If EN = 1, a = a SR c bits a = a SL c bits		Enable : EN In: VB, IB, QB, MB, AC, Constant, LB Out: VB, IB, QB, MB, AC Count: VB, IB, QB, MB, AC, Constant, LB
Shift Right Shift Left	If EN = 1, a = a SR c bits a = a SL c bits		Enable : EN In: VW, T, C, IW, QW, MW, AC, Constant, LW Out: VW, T, C, IW, QW, MW, AC, LW Count: VB, IB, QB, MB, AC, Constant, LB
DWord Shift R DWord Shift L	If EN = 1, a = a SR c bits a = a SL c bits		Enable : EN In: VD, ID, QD, MD, AC, Constant, LD Out: VD, ID, QD, MD, AC, LD Count: VB, IB, QB, MB, AC, Constant, LB

Table 11-19 CONVERSION OPERATIONS

CONVERSION OPERATIONS			
Instruction		Ladder Symbol	Valid Operands
Convert Double Word Integer to a Real	If EN = 1, convert the double word integer i to a real number o.		Enable : EN In: VD, ID, QD, MD, AC, Constant, LD Out: VD, ID, QD, MD, AC, LD

CONVERSION OPERATIONS			
Instruction		Ladder Symbol	Valid Operands
Convert a Real to a Double Word Integer	If EN = 1, convert the real number i to a double word integer o.		Enable : EN In: VD, ID, QD, MD, AC, Constant, LD Out: VD, ID, QD, MD, AC, LD
Convert BCD to Binary	If EN = 1, convert the BCD value IN to a binary value OUT		Enable : EN In: VW, T, C, IW, QW, MW, AC, Constant, LW Out: VW, T, C, IW, QW, MW, AC, LW
Convert Binary to BCD	If EN = 1, convert the binary value IN to a BCD value OUT		Enable : EN In: VW, T, C, IW, QW, MW, AC, Constant, LW Out: VW, T, C, IW, QW, MW, AC, LW

Table 11-20 PROGRAM CONTROL FUNCTIONS

PROGRAM CONTROL FUNCTIONS			
Instruction		Ladder Symbol	Valid Operands
Jump to Label	If EN = 1, go to label n.		Enable : EN Label: WORD: 0-127
Label	Label marker for the jump.		Label: WORD: 0-127
Conditional Return from Subroutine	If EN = 1, exit the subroutine.		Enable : EN
Return from Subroutine	Exit subroutine.		
Conditional End	If EN = 1, END terminates the main scan.		Enable : EN
Subroutine	If EN ≠ 0, go to subroutine n.		Label: Constant : 0-63

Table 11-21 MOVE, FILL AND FIND OPERATIONS

MOVE, FILL AND FIND OPERATIONS		
Instruction	Ladder Symbol	Valid Operands
Move Byte If EN = 1, copy i to o.		Enable : EN In: VB, IB, QB, MB, AC, Constant, LB Out: VB, IB, QB, MB, AC, LB
Move Word If EN = 1, copy i to o.		Enable : EN In: VW, T, C, IW, QW, MW, AC, Constant, LW Out: VW, T, C, IW, QW, MW, AC, LW
Move DWord If EN = 1, copy i to o.		Enable : EN In: VD, ID, QD, MD, AC, Constant, LD Out: VD, ID, QD, MD, AC, LD
Move Real If EN = 1, copy i to o.		Enable : EN In: VD, ID, QD, MD, AC, Constant, LD Out: VD, ID, QD, MD, AC, LD
Swap Bytes If EN = 1, exchange MSB and LSB of w.		Enable : EN In: VW, IW, QW, MW, T, C, AC, LW

11.6.4 Program organization

Each programmer should structure his user program into finished program parts (subroutines). The programming language for S7-200 offers the user the capability to set up his user program in a structured manner. There are two types of programs, the main program and the subroutine. Eight levels of programming are possible.

A PLC cycle can be a simple cycle of the control system-internal interpolation cycle (IPO cycle). The machine manufacturer must set the PLC cycle according to the specific requirements (see machine data "PLC_IPO_TIME_RATIO"). The IPO/ PLC ratio of 1:1 is the fastest possible cyclical processing.

How Do I The programmer writes a sequential control in his main program with the aid of a user-defined cycle counter. This organizes all of the cyclical signals in the subroutine (UP0), UP1/UP2 are called up every two cycles and UP3 controls all of the signals in the grid of three cycles.

11.6.5 Data management

The data can be broken down into three areas:

- non-retentive data
- retentive data
- Machine data for the PLC (These machine data are all POWER ON active.)

The majority of the data, such as the process image, timer and counter are not retentive data and they are cleared each time the control system is powered up.

For the retentive data there is a data range of 1400 0000 -1400 0127. The user can store all data there, which is to remain valid beyond POWER OFF/ON.

With the aid of the PLC-MD (see user interface), the user can pre-assign his program with data or he can parameterize various parts of the program.

11.6.6 Testing and monitoring your program

Checking or performing an error analysis of the user program can be done using:

- PLC Status: Displaying and changing called up operands
- Status list: Displaying and changing three freely selectable variable boxes
- PLC Program: Displaying and monitoring (status) of the entire user program, including symbols and comments
- Programming Tool PLC802: Connecting a PG/PC and activating the programming tool.

11.7 PLC application Download/Upload/Copy/Compare

The user can save, copy or over-write the PLC project or the PLC applications in the control system.

This is possible using:

- Programming Tool PLC802
- RCS802
- CF card

The **PLC project** contains the PLC user program, including all of the important information (symbols, comments, ...). The programming tool performs uploads and downloads into the control system. The PLC project can also be imported and exported by the programming tool in ".pte" format. In this format (*.pte), the project can also be read-in/out using the RCS802 tool or directly at the control system of the CF card.

The **PLC user alarm texts** can be created using the RCS802 tool or the alarm text editor on the control system.

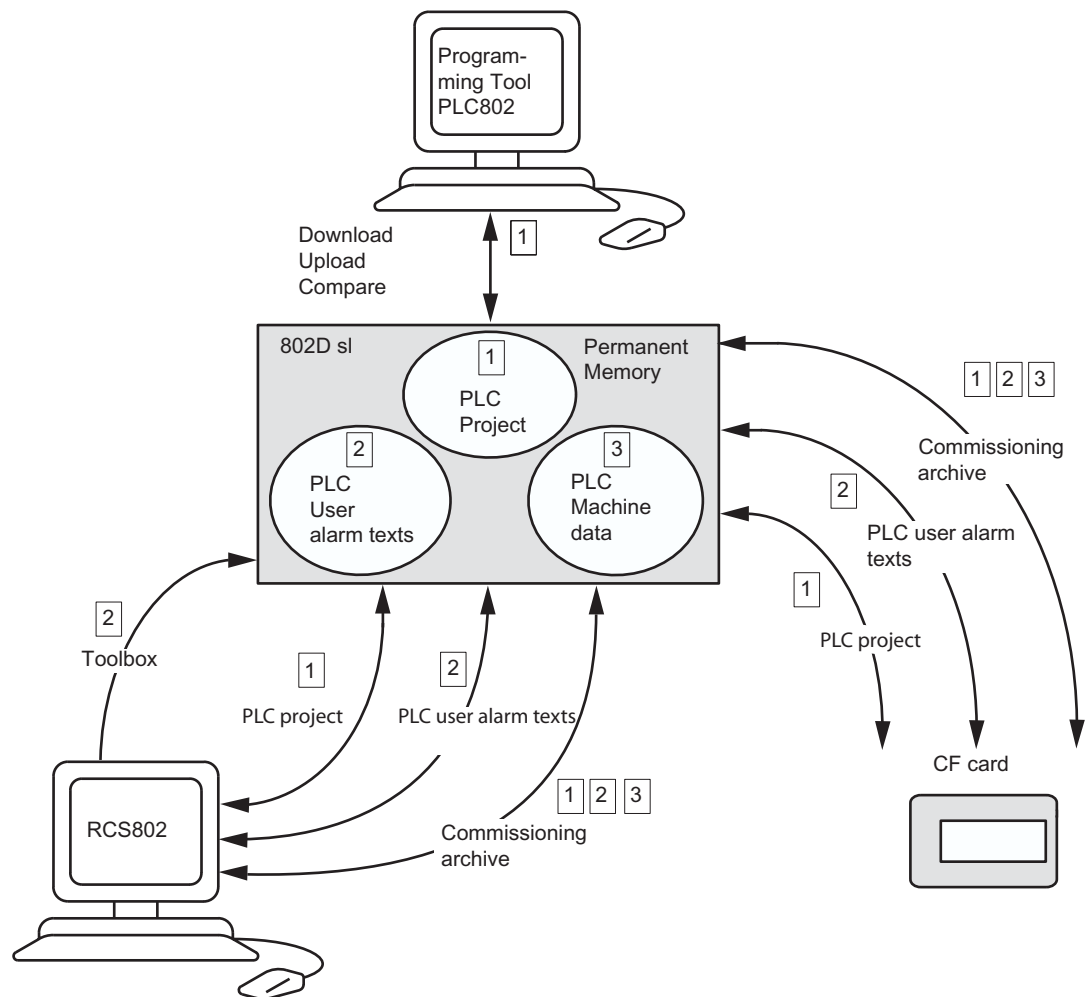

Figure 11-9 PLC applications in the control system

Download

This function writes the transferred data into the permanent memory (load memory) of the control system.

- Download PLC project using the PLC802 programming tool
- Series commissioning (operating area **System <COMMISSIONING Files> <802D Data>** "commissioning archive (NC/PLC)") using the RCS802 tool or the CF card.

For example, for the CF card:

At this point, the commissioning archive of the customer CF card must be copied and pasted into the commissioning files directory > commissioning archive (NC/PLC).

- NC data
- NC directories
- Display machine data
- Leadscrew error compensation data (LEC)

- PLC user program
- PLC user alarm texts
- Drive machine data
- Read-in PLC project with the RCS802 tool or CF card
- Read-in PLC user alarm texts with the RCS802 tool or CF card
- Transfer the PLC user alarm texts from the toolbox project using the RCS802 tool.

Upload

The PLC project can be saved from the permanent memory of the control system using the PLC802 programming tool or the RCS802 tool or the CF card.

- Upload PLC project using the PLC802 programming tool
- Series commissioning (operating area **System <COMMISSIONING Files> <802D Data>** "commissioning archive (NC/PLC)") using the RCS802 tool (PLC machine data, PLC project and user alarm texts) or the CF card
Note: PLC machine data is part of the general machine data.
- Read-out PLC project with the RCS802 tool or copy to a CF card
- Read-out PLC user alarm texts with the RCS802 tool or CF card

Compare

The project in the PLC802 programming tool is compared to the project in the permanent memory (load memory) in the control system.

Version display

Call-up via hardkey **SYSTEM** Softkey **<Service Display> <Version>**

- **PLC Application**
The transferred project that is active in the working memory of the PLC after a control system start up.

In the PLC802 programming tool, in the comments of the properties of OB1, the programmer can use the beginning of the first line of comments for his own additional information in the version display.

11.8 User interface

This interface encompasses all of the signals between the NCK/PLC and the HMI/PLC. In addition, the PLC decodes the auxiliary functions commands for simple further processing in the user program.

Note

See /FB/ SINUMERIK 802D sl "Description of Functions", Chapter 20

Data Backup and Series Machine Start-Up

12.1 Data Backup

12.1.1 Internal data backup

The data of the limited-buffered memory must be saved via a backup copy to the permanent memory of the control system. This backup is performed internally and is always necessary if the control system is switched off for longer than 60 hours.

The buffer time depends on various factors and can reach a value of at least 8 days under normal circumstances (25°C ambient temperature).

Recommendation: After changing important data, it is recommended to carry out a data backup **immediately**.

Note

During the data backup, an image of the limited-buffered memory is produced and stored in the permanent memory. A backup of selected data (e.g. only machine data and no workpiece programs) is not possible.

Performing an internal data backup

Select the **Save data** softkey in the **System** operating area (at least protection level 3 required). Press **<OK>** to confirm the notes which now appear.

Note

While the internal data backup is running, the control system must neither be operated, nor be turned off.

Loading internally backed-up data

- Boot the control system in the commissioning mode "Reload saved user data".
- In case of data loss of the buffered memory, the data saved in the permanent memory are automatically reloaded into the memory with **POWER ON**.

Note

Message "4062 Data backup copy has been loaded" is displayed on the screen.

12.1.2 External data backup

In addition to an internal data backup, the user data of the control system can also be saved externally. To do so, a PC with V24 interface or Ethernet and the **RCS802** tool (included in the toolbox) or a CF card are required.

An external data backup should be performed if major data changes have been made or always at the end of the commissioning.

To create a complete data backup for a machine, it is sufficient to create the series machine start-up file.

Variants of external data backup

1. Reading out the data completely: **Series start-up**
2. Files are read out / read in for each area individually. The following user data can be selected from the "System" operating area as **individual files**:

Data in the text format

- All machine data
- Setting data
- Tool data
- R parameters
- Zero point offset
- Compensation data (LEC)
- Global user data

Start-up archive (NC/PLC)

- NC data
- NC directories
- Display machine data
- Compensation data (LEC)

- PLC user alarm texts
- PLC project (cannot be edited with PT 802)
- Drive machine data

Start-up archive (HMI)

- User cycles
- Customer directories
- Language file SP1
- Language file SP2
- start screen
- Online help
- HMI bitmaps
- Tool geometry database
- Startup data

PLC project (PT802D.PTE)*

3. Furthermore, the following data can be saved from the "Program Manager" operating area:
 - Machine-manufacturer cycles
 - Siemens cycles
 - User cycles
 - Main programs
 - Subroutines

12.1.3 Data backup via the RS232/Ethernet interface

Note

Never connect or disconnect the RS232 cable when the PCU is connected to the mains.

Make sure that the settings of the RS232 interface of the 802D and of the COM port on the PC are identical.

Creating a start-up archive in the PC (data transfer from the control system to the PC)

(See Chapter "Series commissioning")

Data backup in the 802D data area (text format)

One single file will result, which contains the data you have selected for backup.

Note

/BP/ SINUMERIK 802D sl "Operation and Programming", Chapter "Data Backup"

Data backup in the "Program Manager" operating area

The system outputs in text format the data from the **Program Manager <NC directory>** operating area.

Note

/BP/ SINUMERIK 802D sl "Operation and Programming", Chapter "Data Backup"

12.1.4 External data backup via CF Card

On the CF card, the same data can be saved as those which are saved via the serial interface. The selection of the data to be backed up is the same as (**<System> <COMMISSIONING files> <802D Data> <Copy>**), saving to the card is down via **<Customer CF Card>** and **<Insert>**.

12.1.5 Data backup in case of backlight failure

In case of failure of the backlight of the control system, menu-assisted operation is no longer possible. If backlight failure occurs at the control system, you can use a key combination to carry out external data backup on a CF card.

To do so, the CF card must be inserted.

After power-on and booting of the control system, indicated by LEDs on the CNC control panel (RDY and NC), press **<CTRL + S>**.

This will output the series machine start-up archives (NC/PLC and HMI) with the latest current data.

12.2 Series commissioning

Functionality

The objective of the series machine start-up is:

- to bring another control system at a machine of the same type to the same condition as after a commissioning
- or
- to bring a new control system to the initial state in case of servicing (after hardware replacement) with the least expenditure.

Start-up archive (NC/PLC)

The start-up archive (NC/PLC) incorporates the following selectable data:

- Drive machine data
- NC data
- NC directories
- Display machine data
- Compensation data (LEC)
- PLC user alarms
- PLC project

Start-up archive (HMI)

The start-up archive (HMI) incorporates the following data:

- User cycles
- Customer directory
- Language file SP1
- Language file SP2
- start screen
- Online help
- HMI bitmaps
- Tool geometry database
- Startup data

Prerequisites

The prerequisite for the series machine start-up is a PC with V24 interface or Ethernet interface for data transfer from/to the control system, or a CF card.

In the PC, the **RCS802** tool must be used.

Sequence with PC (RCS802)

1. Creating a start-up archive (NC/PLC) in the PC (data transfer from the control system to the PC):
 - Establish a connection between the PC (RCS802) and the control system. The control system requires the password for protection level 2.
 - In the directory tree of the RCS802, open Control 802 > 802D Data (A:), activate the Start-up archive (NC/PLC) directory and click on **Copy** via the context menu (right mouse button).
 - In the directory tree, select the target directory and insert the commissioning archive by clicking on **Paste** via the context menu.
2. Reading in the series start-up file from the PC into the control system
 - Establish a connection between the PC (RCS802) and the control system. The control system requires the password for protection level 2.
 - In the directory tree of RCS802, select the commissioning archive to be transferred and click on **Copy** via the context menu (right mouse button).
 - In the directory tree of the RCS802, open Control 802 > 802D Data (A:), activate the Start-up archive (NC/PLC) directory and click on **Paste** via the context menu (right mouse button).
 - The series commissioning then commences. A warm start of the NC/PLC is performed several times. At the end of the series machine start-up, the whole control system will reboot (warm start). After an error-free series machine start-up, the control system will be in a fully configured operating condition.

Note

Start-up archive (HMI)

This data backup is created analogously to the start-up archive (NC/PLC). For creating and reading, you must activate the Start-up archive (HMI) directory instead of the Start-up archive (NC/PLC) directory in the directory tree of the RCS802.

Sequence with CF card

1. Creating a series machine start-up file on the CF card:
 - Make sure that the CF card is inserted in the slot on the device front panel.
 - The control system requires the password for protection level 2.
 - Under the menu **<System> <COMMISSIONING Files> <802D Data>** select the line **"Commissioning Archive (NC/PLC)"** and copy it to the clipboard using **<Copy>**. Select the **<Customer CF card>** softkey to display the contents of the inserted card. If you select the **<Paste>** softkey and subsequently enter the name for the archive file, the series commissioning is produced on the card.
2. Reading in the series start-up file from the CF card into the SINUMERIK 802D sl
 - Make sure that the CF card is inserted.
 - The control system requires the password for protection level 2.

- Under the **System** > **<COMMISSIONING Files >** < **Customer CF card** menu, select the line containing the desired archive and use **Copy** to paste the data to the clipboard. Select the **<802D data>** softkey and select the "Commissioning archive (NC/PLC)" line. Selecting the **<Paste>** softkey will transmit the series commissioning to the control system.
- Once reading-in has started, confirm the start of the series commissioning in the control system in the screen that appears.
- A warm start of the NC/PLC is performed several times during the series machine start-up. At the end of the series machine start-up, the whole control system will reboot (warm start). After an error-free series machine start-up, the control system will be in a fully configured operating condition.

Technical data

User data memory

Compact Flash Card, type 1 (CF Card)

Connected loads of the PCU

Table 13-1 Connected loads

Supply voltage	24 V DC (permissible range: 20.4...28.8 V)
Ripple	3.6 Vpp
Current consumption from 24 V	Basic configuration typically 1.5 A (inputs/outputs open)
Power loss	max. 50 W
<ul style="list-style-type: none"> • CNC operator panel (PCU) with NC full keyboard • Machine control panel • PP72/48 I/O module 	≤ 5 W max. 11 W
Starting current, total	5 A

Dimensions and weight

Table 13-2 Dimensions and weight

CNC operator panel (PCU)	
Dimensions W × H × D (mm)	310 x 330 x 85 310 x 330 x 101 with MCPA module
Weight [g]	approx. 4,900
NC full keyboard (upright design)	
Dimensions W × H × D (mm)	310 175 32
Weight [g]	approx. 1,700
NC full keyboard (vertical design)	
Dimensions W × H × D (mm)	172 x 330 x 32
Weight [g]	approx. 1,700
Machine control panel	
Dimensions W × H × D (mm)	170 x 330 x 128
Weight [g]	approx. 1,500
PP72/48 I/O module	
Dimensions W × H × D (mm)	194 x 325 x 35

Weight [g]	<ul style="list-style-type: none"> without mounting plate with mounting plate 	<ul style="list-style-type: none"> approx. 300 approx. 1,200
MCPA module		
Dimensions W × H × D (mm)	89 × 205 × 68	
Weight [g]	approx. 300	

Digital inputs of the PP72/48 I/O module (as per IEC 1131-2 / DIN EN 61131-2, type 2 characteristic)

Table 13-3 Digital inputs of the PP72/48 I/O module

Number of inputs	24 each per terminal strip converter			
parameters	min.	Standard	Maximum	Nominal
Voltage with high level (U_H)	15 V	¹⁾	30 V	24 V
Input current I_{in} at U_H	2 mA	-	15 mA	-
Voltage with low level (U_L)	-30 V	-	5 V	0 V
Signal delay time T_{PHL} ²⁾	0.5 ms	-	3 ms	-

¹⁾ Supply voltage of the digital inputs
 typical output voltage: $V_{CC} - I_{OUT} * R_{ON}$
 V_{CC} : current operating voltage (P24OUT_{INT}) to X111, X222, X333: Pin 2

²⁾ In addition, take into account the PROFIBUS-DP communication time and the application cycle time.

Polarity reversal causes neither high level nor destruction of the inputs.

Digital outputs of the PP72/48 (as per IEC 1131-2 / DIN EN 61131-2)

Table 13-4 Digital outputs of the PP72/48 I/O module

Number of outputs	16 each per terminal strip converter			
parameters	min.	Standard	Maximum	Nominal
Voltage with high level (U_H)	$V_{CC} - 3 V$	¹⁾	V_{CC}	24 V
I_{out}	-	-	0.25 A	-
Voltage with low level (U_L)	-	-	-	Output open
Leakage current at low level	-	50 μA	400 μA	-
Signal delay time T_{PHL} ²⁾	-	-	0.5 ms	-
max. switching frequency ²⁾	100 Hz	-	-	-
<ul style="list-style-type: none"> resistive load inductive load Lamp 	2 Hz 11 Hz	- -	- -	- -

Number of outputs	16 each per terminal strip converter
<p>1) Supply voltage of the digital outputs typical output voltage: $V_{CC} - I_{OUT} * R_{ON}$ V_{CC}: Current operating voltage Max. output current I_{OUT}: 0.25 A max. short-circuit current: 4 A (max. 100 μs, $V_{CC} = 24$ V) Inner flow resistance R_{ON}: 0.4 Ω</p> <p>2) In addition, take into account the PROFIBUS–DP communication time and the application cycle time.</p> <p>Incorrect connection causes neither high level nor destruction of the outputs.</p>	

General electric features:

- Galvanic isolation using optocouplers
- Current limited to max. 0.25 A
- Protection against:
 - short-circuit
 - Overtemperature
 - loss of grounding
- Automatic disconnection in case of undervoltage

13.1 Electro-Magnetic Compatibility

Definition

Electromagnetic compatibility refers to the capability of electrical equipment in reliably performing its dedicated function in an electromagnetic environment, without causing interference in the same environment.

Emission of Radio Interferences

Table 13-5 Interference emission of electromagnetic fields as per EN 55011: Limit value class A, group 1.

between 20 and 230 MHz	<30 dB (μ V/m) Q
between 230 and 1000 MHz	<37 dB (μ V/m) Q
measured at a distance of 30 m	

Table 13-6 Interference emission via network alternating current supply in accordance with EN 55011: Limit value class A, group 1.

between 0.15 and 0.5 MHz	<79 dB (μ V) Q
	<66 dB (μ V) M

13.2 Transport and storage conditions

between 0.5 and 5 MHz	<73 dB (μV) Q <60 dB (μV) M
between 5 and 30 MHz	<73 dB (μV) Q <60 dB (μV) M

Extension of the range of application

If you intend to use the control system in residential areas, you must ensure that the control system meets the requirements of limit value class B to EN 55011 in respect of interference emission.

Recommendation: Install the control system in grounded metal cabinets, such as 8MC cabinets (see NV 21 Catalog). Connect filters to the supply lines.

13.2 Transport and storage conditions

The following data applies to modules that are transported or stored in the original packaging.

Table 13-7 Shipping and storage conditions

Type of condition	Permissible range
Free fall	≤ 1m
Temperature	-20°C to +60°C
Atmospheric pressure	1,060 ... 700 hPa (corresponds to an altitude of 3,000)
Relative humidity	5% to 95%, without condensation

13.3 Ambient operating conditions for the operation

Conditions of use

The control system is intended for use as a stationary equipment in a sheltered environment. The conditions of use are compliant with requirements to DIN IEC 68–2–2:

The control system satisfies the operating conditions of the 3C3 class in accordance with DIN EN 607213-3 (operating locations with high traffic densities and in the immediate vicinity of industrial plants with chemical emissions).

The control system must not be operated without additional measures being taken

- in locations with a high proportion of ionizing radiation
- Locations with severe operating conditions, e.g. due to:
 - dust
 - caustic vapor or gases.

- in plants which require special supervision, e.g.
 - Elevator systems
 - electrical equipment in especially hazardous rooms.

An additional measure for use of the control system may be, for example, the installation in cabinets.

Climatic environmental conditions

The control system can be used under the following climatic ambient conditions:

Table 13-8 Climatic environmental conditions

Environmental conditions	Fields of application	Remarks
Temperature	0 to 50 °C	with a simultaneity of 50 %
Relative humidity	from 5% to 95 %	Without condensation, corresponds to relative humidity (RH) severity level 2 in accordance with IEC 1131-2
Atmospheric pressure	from 1,080 to 795 hPa	-
Concentration of pollutants	SO ₂ : <0.5 ppm; Relative humidity <60 %, no condensation H ₂ S: <0.1 ppm; Relative humidity <60 %, no condensation	Test: 10 ppm; 4 days 1 ppm; 4 days

Mechanical ambient conditions

The mechanical ambient conditions for the control system are specified in the table below in the form of sinusoidal waves.

Table 13-9 Mechanical ambient conditions

Mechanical ambient conditions	Operation	Transport (in packaging)
Vibration tested as per DIN EN 60068-2-68	10..0.58 Hz: 0.35 mm 58 to 200 Hz: 50 m/s ²	5...9 Hz: 3.5 mm 9 to 200 Hz: 10 m/s ²
Shock resistance tested in accordance with DIN EN 60068-2-27	10 g peak value, 6 ms duration 100 shocks in each of the 3 axes vertical to one another	10 g peak value, 6 ms duration 100 shocks in each of the 3 axes vertical to one another

Reduction of vibration

If the control system is subjected to major impacts or vibration, appropriate measures must be taken to reduce the acceleration or the amplitude of the vibration.

We recommend mounting the control system on shock-absorbing material (e.g. vibration-absorbing metal).

13.4 Specifications for Protection Class and Degree of Protection

Protection class

Safety class I as per DIN EN 61140, i.e. protective conductor connection required!

Protection against ingress of solid foreign bodies and water

Degree of protection per DIN EN 60529:

- CNC operator panel (PCU) IP65 (front)
IP00 (rear)
- Machine control panel (MCP) IP54 (front)
IP00 (rear)
- PP 72/48 I/O module IP00

Dimensional Drawings

14.1 CNC operator panel (PCU) dimension drawing and hole drilling template

Note

Dimensions marked with 1) are minimum clearances to adjacent modules.

14.1 CNC operator panel (PCU) dimension drawing and hole drilling template

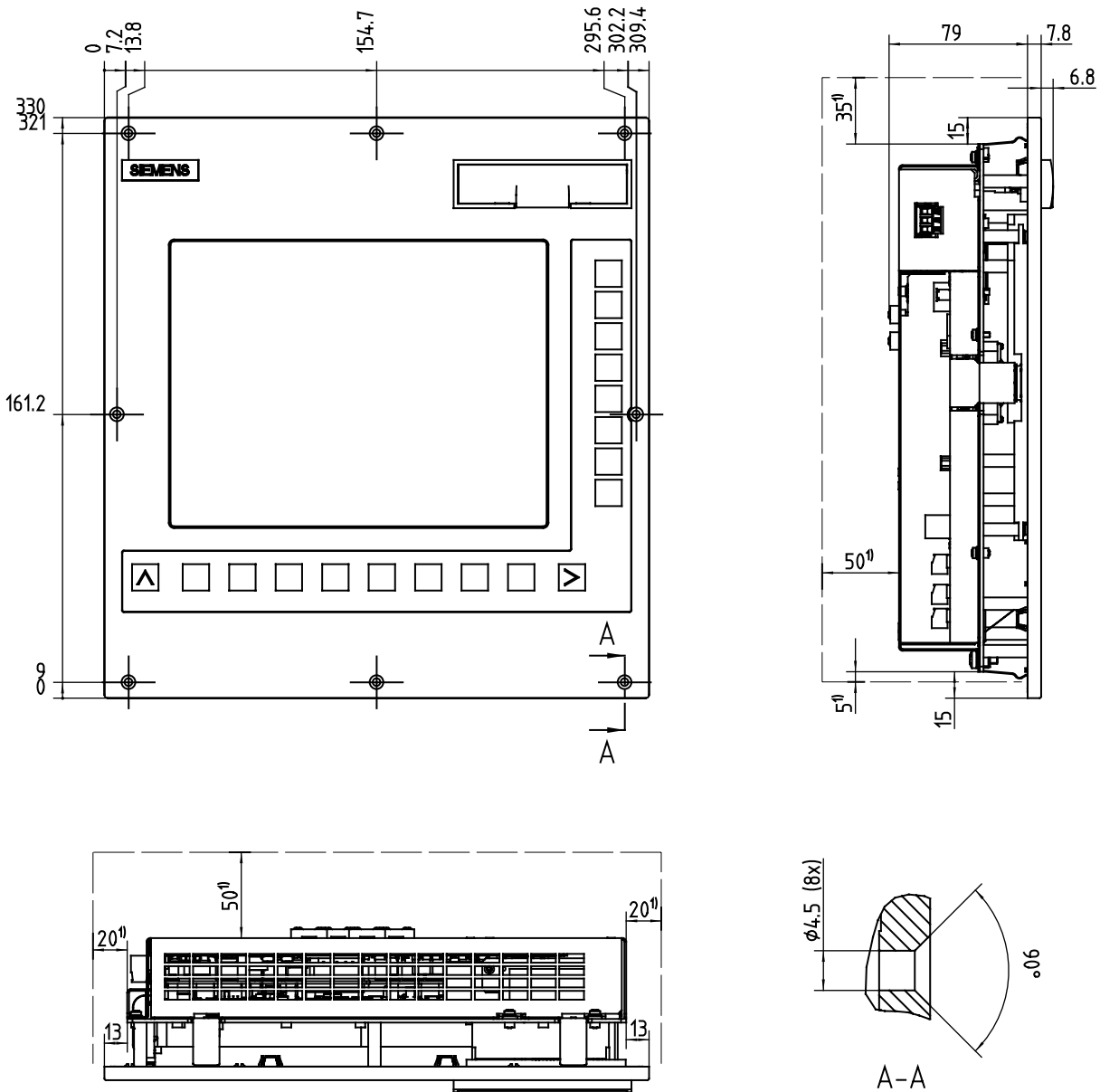

Figure 14-1 CNC operator panel (PCU) dimensional drawing

14.1 CNC operator panel (PCU) dimension drawing and hole drilling template

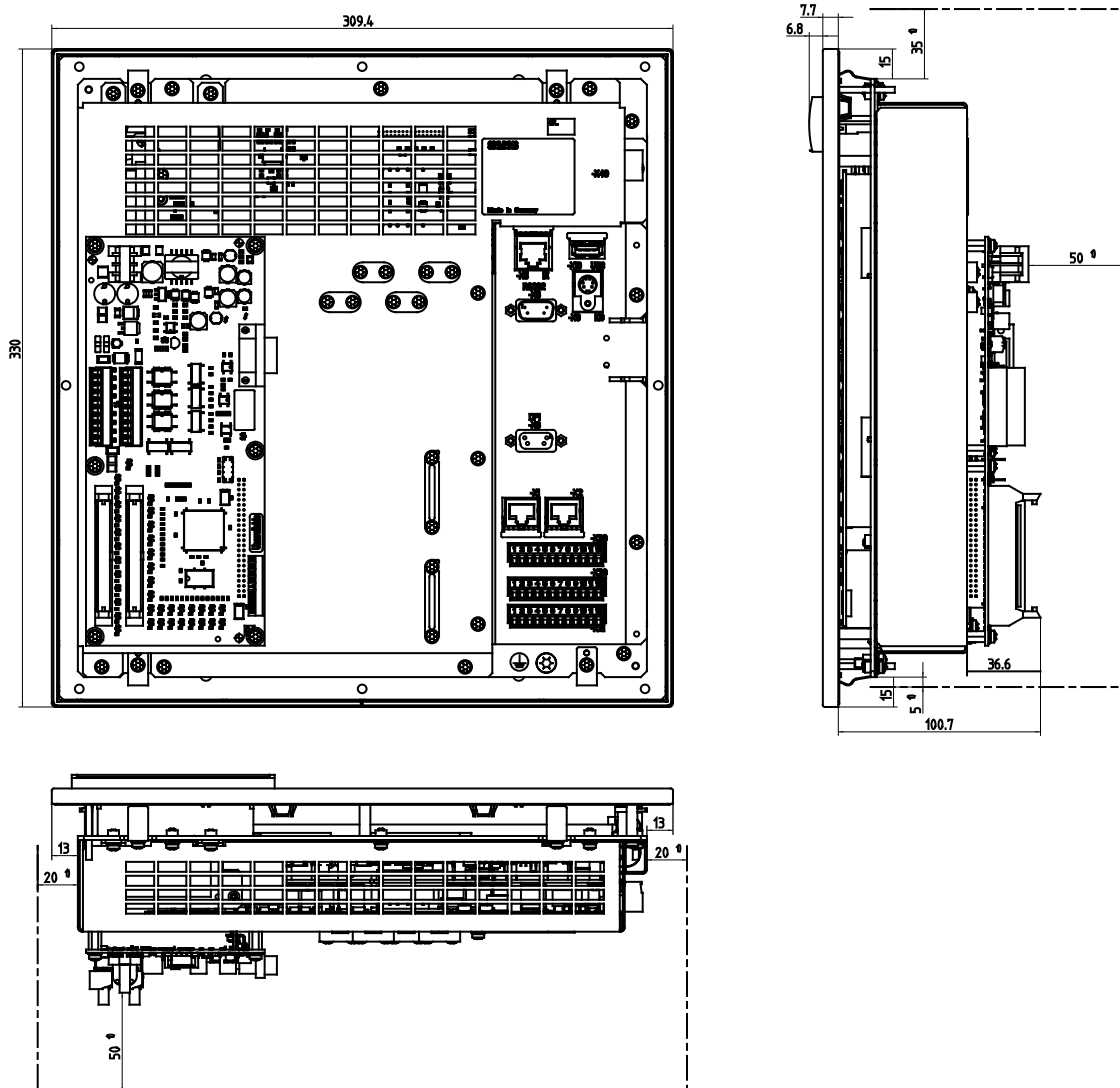

Figure 14-2 Dimensional drawing CNC operator panel with MCPA module

14.1 CNC operator panel (PCU) dimension drawing and hole drilling template

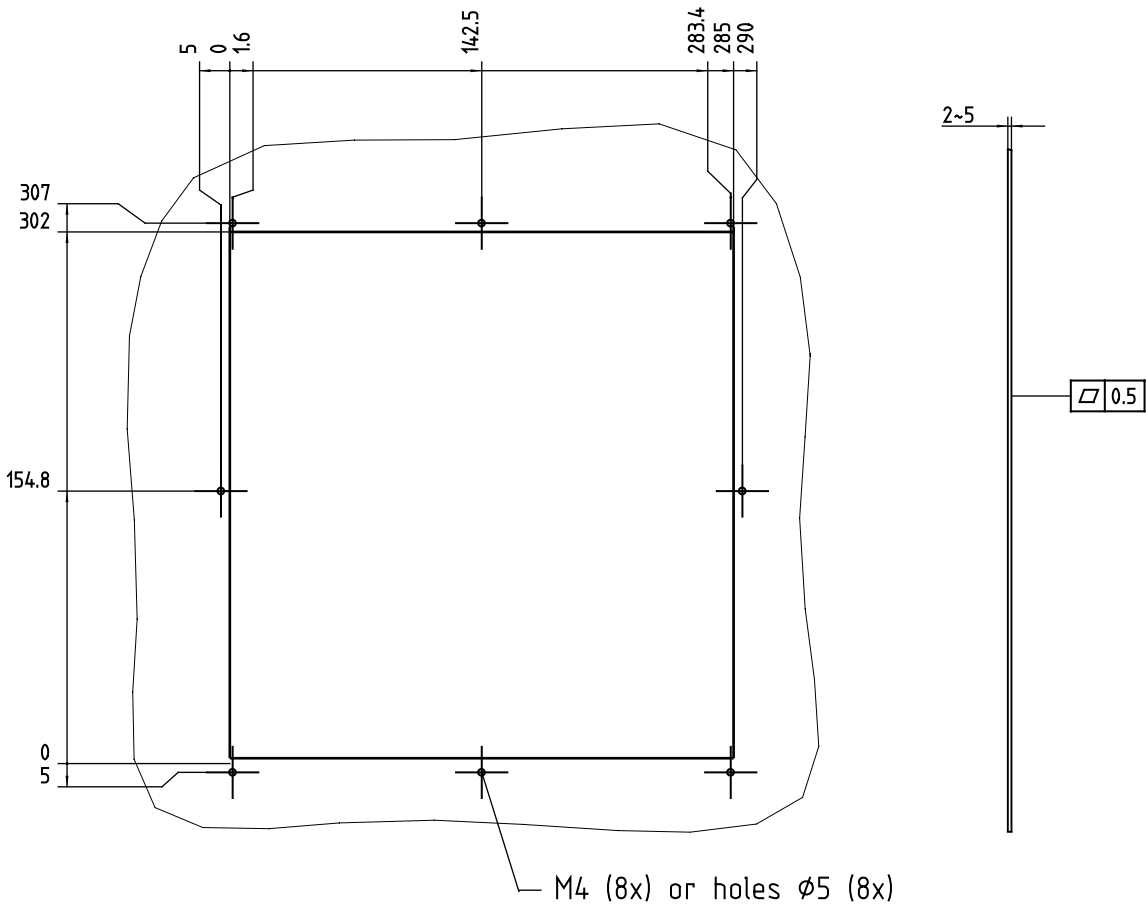

Figure 14-3 CNC operator panel (PCU) hole drilling template

14.2 Dimensions and hole drilling template of the machine control panel (MCP)

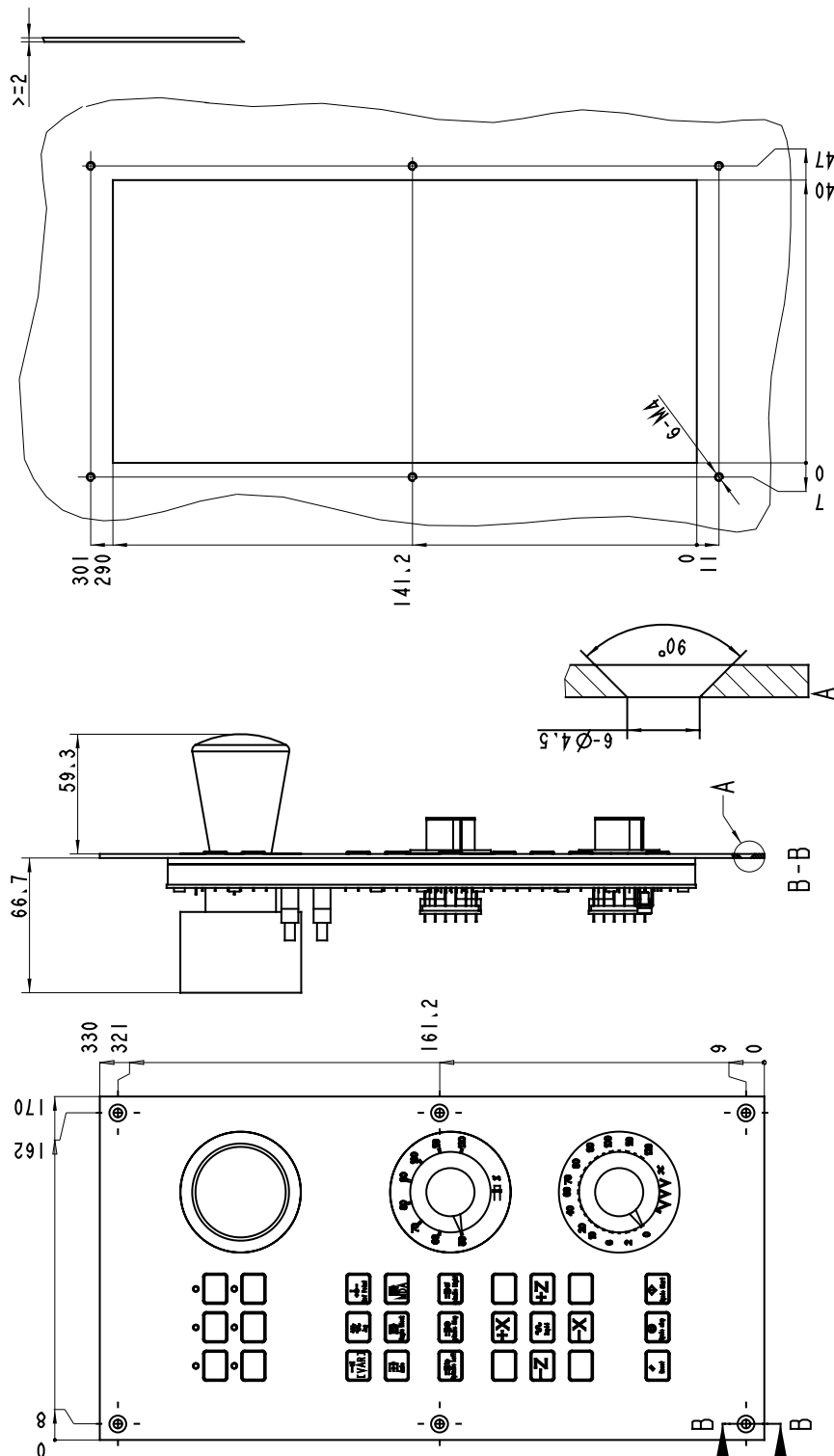

Figure 14-4 Dimension and hole drilling template of the machine control panel MCP

14.2 Dimensions and hole drilling template of the machine control panel (MCP)

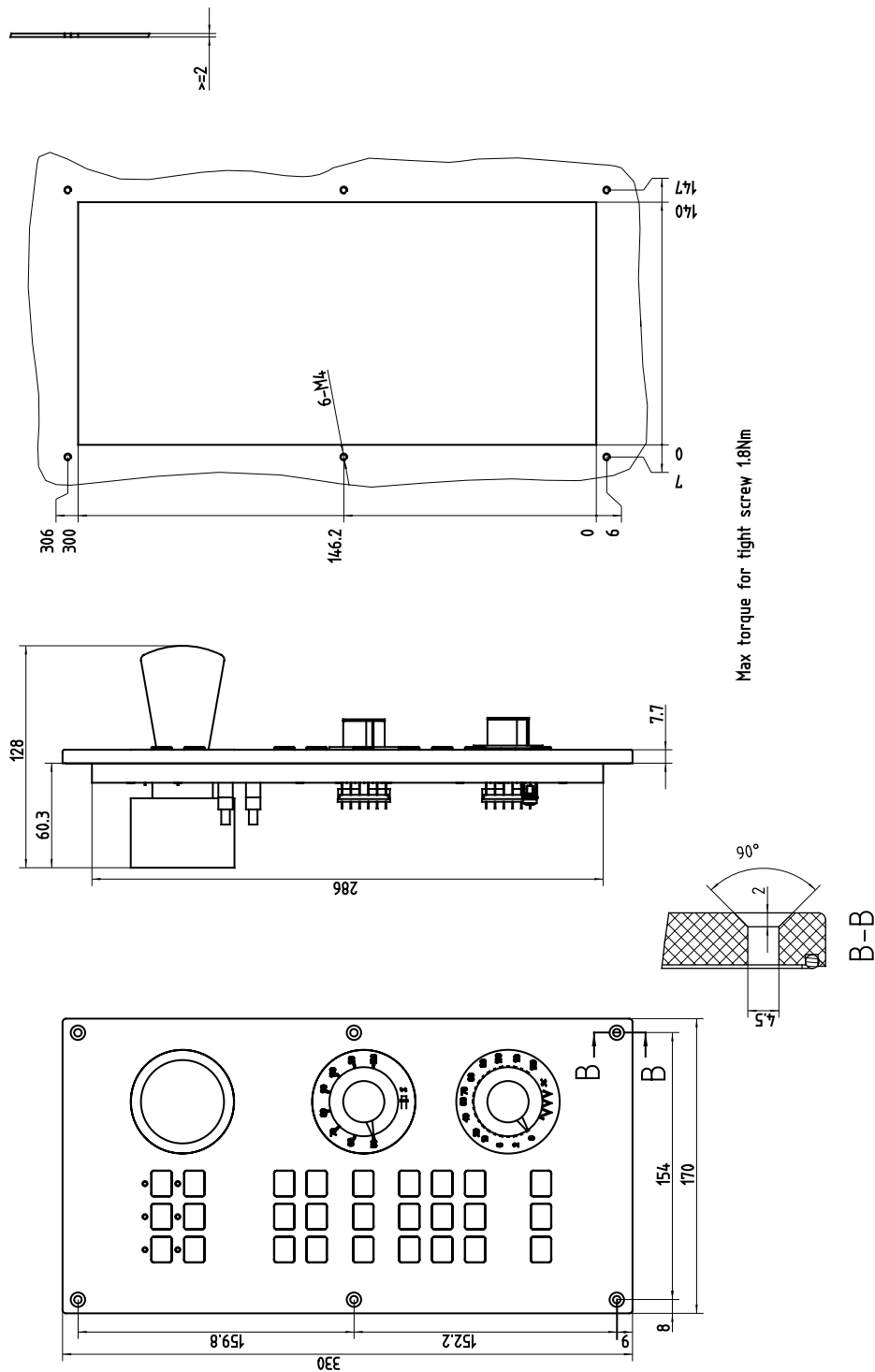

Figure 14-5 Dimension and hole drilling template of the machine control panel MCP 802D sl

14.3 NC full keyboard dimension and hole drilling templates

Dimensional drawing and hole drilling template of the NC full keyboard (installed next to the PCU)

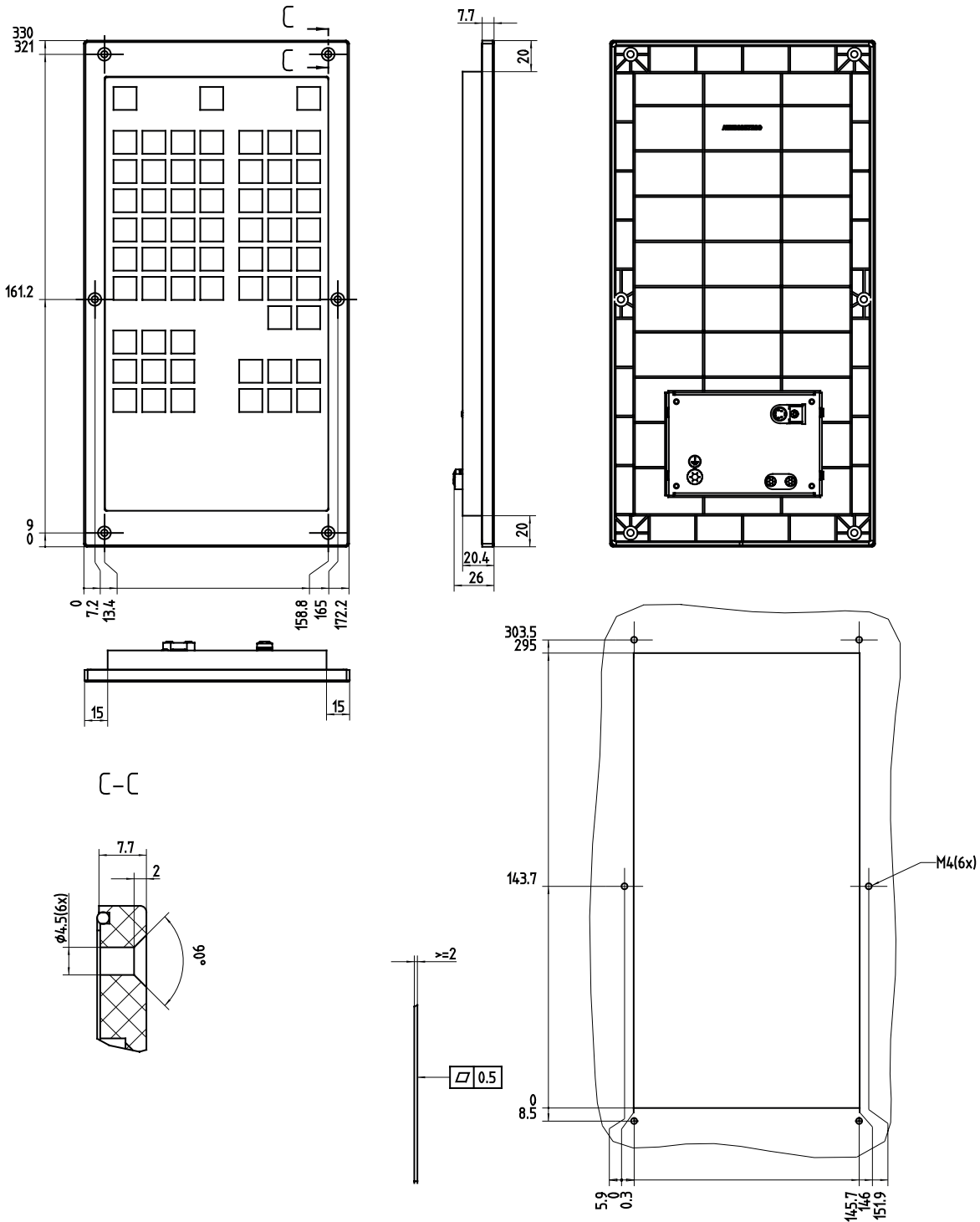

Figure 14-6 Dimensional drawing and hole drilling template of the NC full keyboard (installed next to the PCU)

Dimensional drawing and hole drilling template of the NC full keyboard (installed under the PCU)

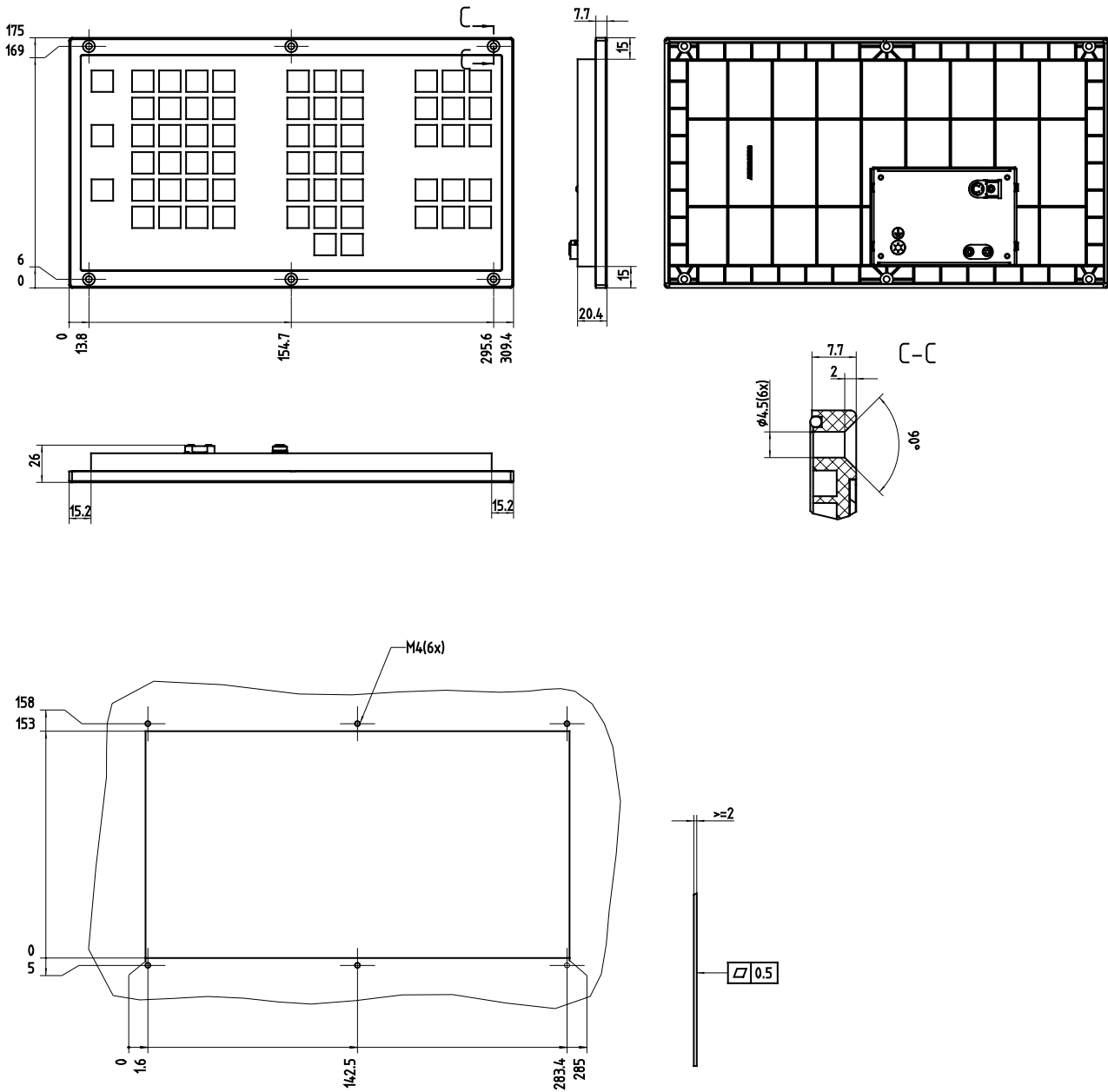

Figure 14-7 Dimensional drawing and hole drilling template of the NC full keyboard (installed under the PCU)

14.4 PP72/48 peripheral module dimension drawing

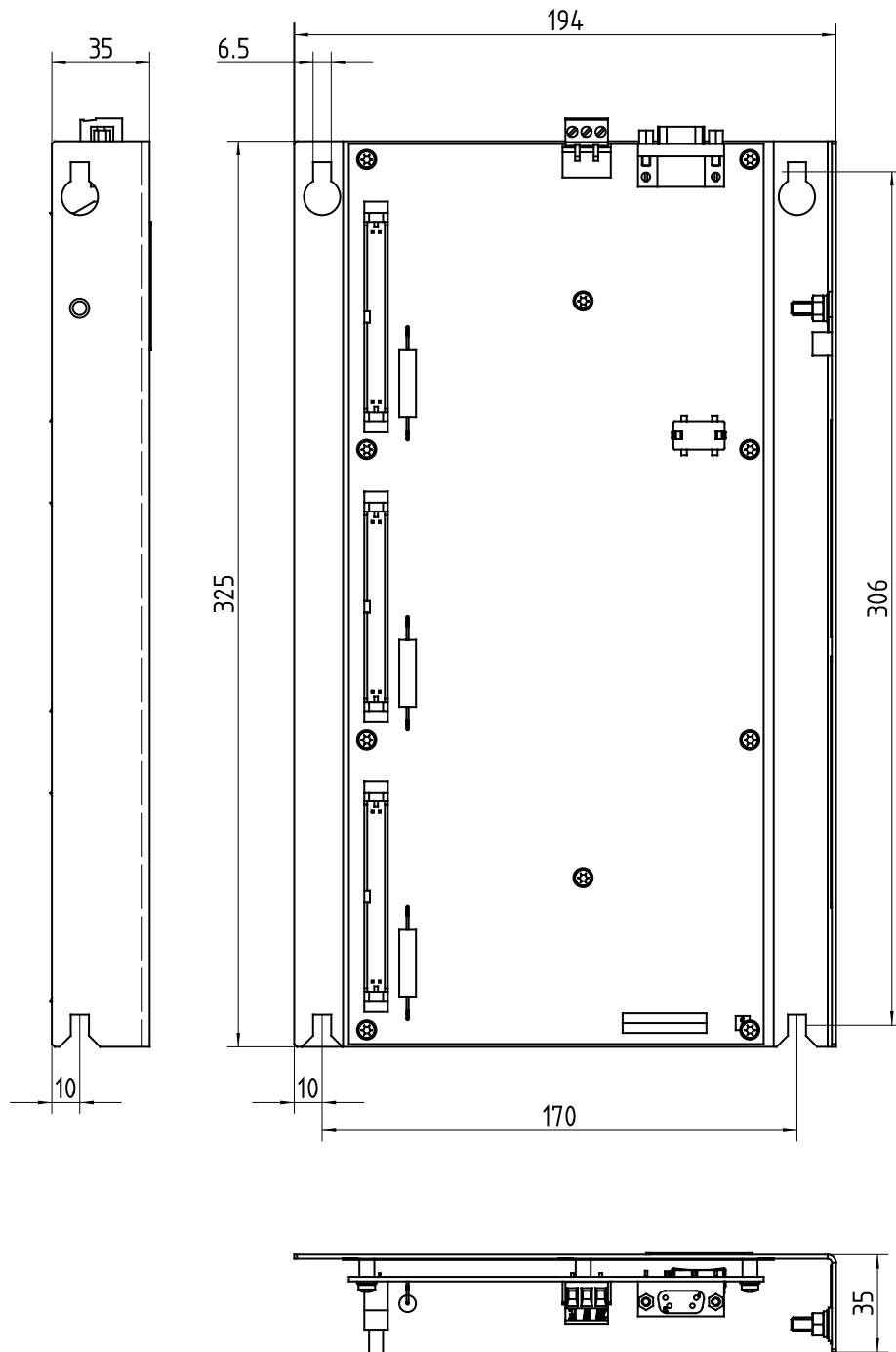

Figure 14-8 PP72/-48 peripheral module dimensional drawing

14.5 Dimensional drawing MCPA module

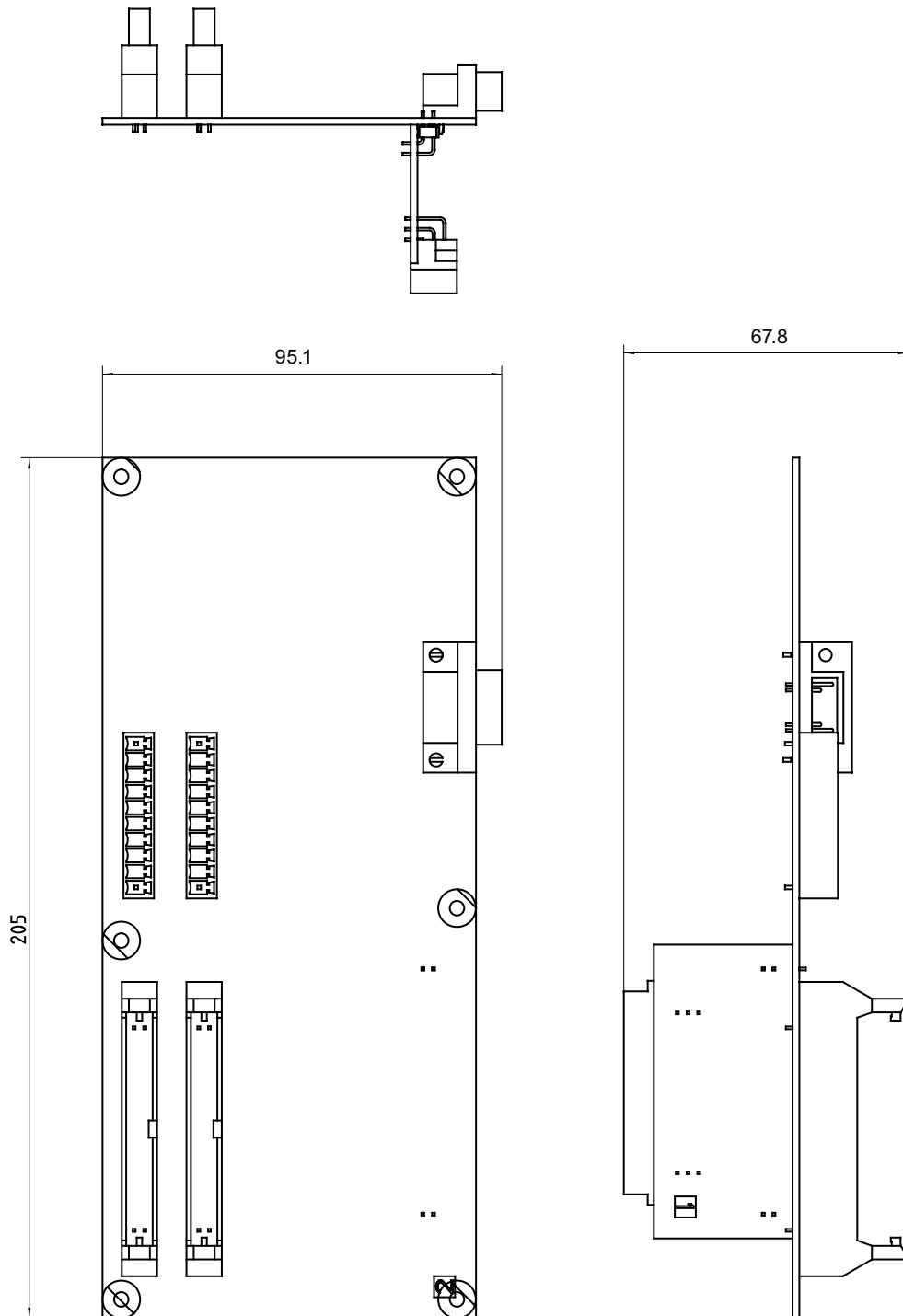

Figure 14-9 Dimensional drawing MCPA module

ESD guidelines

A.1 What does ESD mean?

Definition

All electronic modules are equipped with highly integrated modules or components. Based on their design, these electronic components are highly sensitive to overvoltage and thus to discharge of static electricity.

These **Electrostatic Sensitive Devices/Modules** are commonly abbreviated **ESD**. The common international designation **ESD** stands for **Electrostatic Sensitive Device**.

Electrostatic sensitive modules are identified by the following symbol:

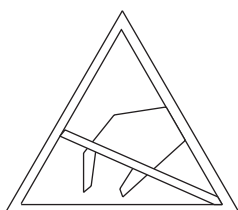

Caution

Electrostatic sensitive devices may be destroyed by voltages that are undetectable to a human. Voltages of this kind occur as soon as a component or an assembly is touched by a person who is not grounded against static electricity. The damage to a module as a result of overvoltage cannot usually be detected immediately. It may only become apparent after a long period of operation.

A.2 Electrostatic Discharge to Persons

Charge

Anyone who is not connected to the electrical potential of their surroundings can be electrostatically charged.

Figure NO TAGE indicates the maximum electrostatic voltages that can accumulate in a person who is operating equipment when he/she comes into contact with the materials shown in the figure. These values correspond with specifications to IEC 801-2.

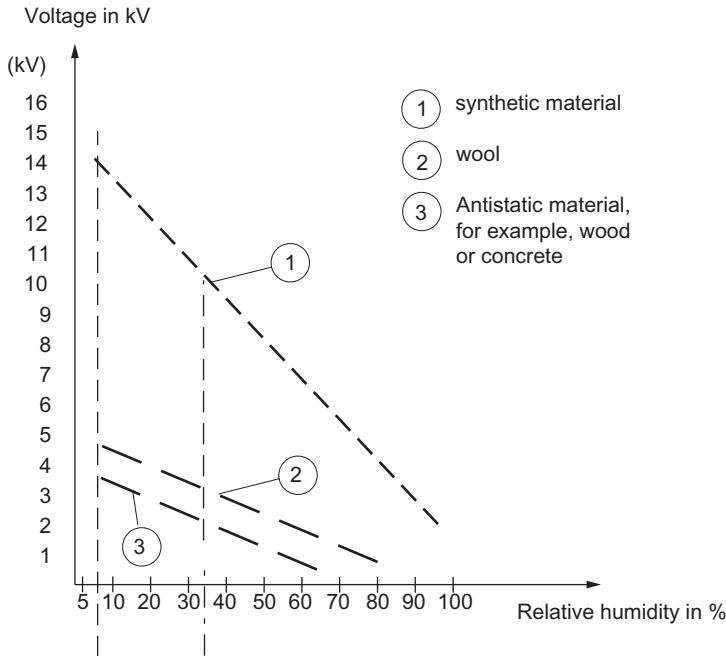

Figure A-1 Electrostatic Voltages which can Build up on a Person

A.3 Basic protective measures against discharge of static electricity

Make sure the grounding is good

When working with electrostatically sensitive devices, make sure that the person, the workstation and the packaging are properly grounded. This helps you avoid static charge.

Avoid direct contact

Electrostatically sensitive devices should only be touched if this cannot be avoided (e.g. when performing maintenance work). When you touch modules, make sure that you do not touch either the pins on the modules or the printed conductors. This prevents any discharge of static electricity to sensitive component and thus avoids damage.

Discharge your body before beginning work on a module. To do so, touch a grounded metallic object. Use only grounded measuring and test equipment.

List of abbreviations

B.1 Abbreviations 802D sl

Abbreviation	German	English
AC	Alternating Current	Alternating current
ALM	Active line module	Active line module
BERO	Tradename for a type of proximity switch	Tradename for a type of proximity switch
BICO	Binector Connector Technology	Binector Connector Technology
CBC	Communication Board CAN	Communication Board CAN
CBE	Communication Board Ethernet	Communication Board Ethernet
CPU	Central processing unit	Central processing unit
CNC	Computer Numerical Control	Computer Numerical Control
CSM	Control Supply Modules	Control Supply Modules
CU	Control Unit	Control Unit
DC	Direct current	Direct Current
DO	Drive object	Drive Object
DP	Distributed I/O	Decentralized Peripherals
DRIVE-CLiQ	Drive Component Link with IQ	Drive Component Link with IQ
EP	Pulse enable	Enable Pulses
EMC	Electro-Magnetic Compatibility	Electromagnetic Compatibility (EMC)
EN	European Standard	European Standard
FI	Residual Current Circuit Breaker	Earth Leakage Circuit Breaker (ELCB)
HMI	Man-machine interface	Human Machine Interface
IEC	International Electrotechnical Commission	International Electrotechnical Commission
IT	Insulated three-phase supply network	Insulated three-phase supply network
LED	Light-emitting diode	Light Emitting Diode
LM	Line Module	Line Module
NC	Numerical Control	Numerical Control
NCK	NC kernel with block preparation, traversing range, etc.	Numerical Control Kernel
NCU	Numerical Control Unit	Numerical Control Unit
NX	Numerical Extension	Numerical Extension
OP	Operator panel front	Operator Panel
PCU	CNC integrated into the operator panel for user interface, system software and soft PLC	Panel Control Unit
PI	Protective earth	Protective Earth

List of abbreviations

B.1 Abbreviations 802D sl

Abbreviation	German	English
PELV	Safety Extra-Low Voltage	Safety Extra-Low Voltage
PLC	Programmable Logical Controller	Programmable Logic Controller
SBC	Safe Brake Control	Safe Brake Control
SH	Safe stop	Safe standstill
SIL	Safety Integrity Level	Safety Integrity Level
SLM	Smart line modules	Smart line modules
SMC	Sensor Module Cabinet	Sensor Module Cabinet
SME	Sensor Module External	Sensor Module External
SPL	Safe Programmable Logic	Safe Programmable Logic
STW	Control word	Control word
TCU	Thin Client Unit	Thin Client Unit
TM	Terminal Module	Terminal Module
TN	Grounded three-phase supply network	Grounded three-phase supply network
TT	Grounded three-phase supply network	Grounded three-phase supply network
VPM	Voltage Protection Module	Voltage Protection Module
VS	Power supply	Voltage Supply
VSM	Voltage Sensing Module	Voltage Sensing Module
ZSW	Status Word	Status word

Index

A

Access levels, 70
Analog output
 Assignment, 31
Analog spindle
 Connecting, 53

B

BERO, 64
Bus connector
 setting the terminating resistor, 59
 wiring, 59

C

CNC full keyboard (installed next to the PCU)
 Dimensional drawing, 197
CNC full keyboard (installed under the PCU)
 Dimensional drawing, 198
CNC operator panel (PCU)
 Dimensional drawing, 192
 Hole drilling template, 194
COM interface connection, 57
Commissioning modes of the PLC, 154
Compact flash card (CF card) slot, 19, 21
Conditions of use, 188
Connected loads, 185
Connecting, 43
Connecting the digital inputs/outputs, 64
 at the I/O module, 64
 to the CNC operator panel, 64
Connecting the machine control, 65
Connecting the SINAMICS S drive, 63
Connection cables, 64
Connection for the CNC full keyboard, 57
Connection for the CNC full keyboard, 19
Connection Overview, 51
Control panel, 136
Control Panel, 139
Control word CTW1, 142

D

Data Backup
 external, 178
 in case of backlight failure, 180
 Internal, 177
Data management, 172
Description, 17
Description of the PP 72/48 I/O module
 Operating elements, 35
Detailed view, 72
Diagnosis via STARTER, 74
Diagnostics function, 74
 Function generator, 75
 Trace, 78
Digital inputs, 25
 Assignment, 26, 30, 36
 Description, 28, 36
 Technical data, 186
Digital inputs/digital outputs (PCU), 19
digital outputs, 25
 Assignment, 26, 36
 Description, 28
Digital outputs
 Assignment, 30
 Description, 36
 Technical data, 186
Dimensional drawings, 192, 197, 198
Dimensions, 185
Drill patterns, 194
DRIVE-CLiQ interface, 19, 24

E

Electrical design
 Configuration, 44
Electro-Magnetic Compatibility, 187
EMC Directives, 43
EMERGENCY STOP concept, 43
Entering the machine data, 88
Environmental conditions, 188
 Mechanical, 189
Error displays, 67

Ethernet interface, 19, 21
Ethernet interface connection, 57

F

Function Generator
Features, 76

G

Generator for signals, 75

H

Handwheel connection, 19, 24

I

I/O device interface, 35, 36
Illustration of the CNC operator panel (PCU)
interfaces, 18
Installation, 47
Interface for MCPA module, 19

L

Language setting, 82
Layout
electrical:configuration, 44

M

Machine control, 65
Machine control panel (MCP 802D sl), 196
Machine control panel (MCP), 195
MCPA module, 28
Measuring probe, 64
Modules
Shipping and storage conditions, 188
Motor turning, 136
Mounting
the shield connection, 65

O

Operator control and display elements, 67
Operator interface, 72

P

PCU interfaces, 18
Compact flash card (CF card) slot, 21
Digital inputs/outputs, 25
Ethernet interface, 21
Handwheel connection, 24
PROFIBUS DP interface, 23
RS232 COM interface, 22
Peripheral (I/O) module connection, 58
Place shielded cables, 65
PLC alarms, 156
PLC command overview, 161
PLC Programming, 159
Power supply connection, 19, 35, 55
PP 72/48 interfaces, 35
I/O device interface, 36
Product Overview, 13
PROFIBUS address, 90
PROFIBUS DP connection, 58
PROFIBUS DP interface, 35
PROFIBUS DP1 interface, 19
PROFIBUS interface, 23
Program organization, 171
Project navigator, 72
Protection levels, 70
Protective conductor, 50

R

Radio Interference
Emission of, 187
RCS tool, 71
Recorder, 78
RS232 COM interface, 22
RS232 COM port, 19

S

Safety regulations, 43
EMERGENCY OFF equipment, 43
Setpoint/actual value assignment, 93
Setting the technology, 86
Shield connection, 65
Signal recording with the trace function, 75
STARTER commissioning tool, 72
Start-up
Axis/spindle, 93
Exit, 105
PLC, 147
Series startup, 181
Status displays, 67

T

technical data, 185

Technical data

 Digital inputs, 186

 Digital outputs, 186

Terminal strip converter, 36

Terminating resistor

 Adjusting to bus connector, 59

Trace, 78

Trace function

 Signal recording, 75

U

USB interface, 19

User alarms, 157

Using the STARTER control panel, 136

V

Vibration, 189

W

Weight, 185

wiring

 Bus connector, 59

Work Area, 72



www.nicsanat.com

021-87700210