

SIEMENS

SINUMERIK

SINUMERIK 808D Milling Part 1: Operation

Programming and Operating Manual



www.nicsanat.com

021-87700210

Valid for:
SINUMERIK 808D Milling (software version: V4.4.2)

Target group:
End users and service engineers

12/2012
6FC5398-4DP10-0BA0

Preface	
Introduction	1
Turning on, reference point approach	2
Setting-up	3
Part programming	4
Automatic machining	5
System	6
Data backup	7
Appendix	A

Legal information

Warning notice system

This manual contains notices you have to observe in order to ensure your personal safety, as well as to prevent damage to property. The notices referring to your personal safety are highlighted in the manual by a safety alert symbol, notices referring only to property damage have no safety alert symbol. These notices shown below are graded according to the degree of danger.

DANGER

indicates that death or severe personal injury **will** result if proper precautions are not taken.

WARNING

indicates that death or severe personal injury **may** result if proper precautions are not taken.

CAUTION

indicates that minor personal injury can result if proper precautions are not taken.

NOTICE

indicates that property damage can result if proper precautions are not taken.

If more than one degree of danger is present, the warning notice representing the highest degree of danger will be used. A notice warning of injury to persons with a safety alert symbol may also include a warning relating to property damage.

Qualified Personnel

The product/system described in this documentation may be operated only by **personnel qualified** for the specific task in accordance with the relevant documentation, in particular its warning notices and safety instructions. Qualified personnel are those who, based on their training and experience, are capable of identifying risks and avoiding potential hazards when working with these products/systems.

Proper use of Siemens products

Note the following:

WARNING

Siemens products may only be used for the applications described in the catalog and in the relevant technical documentation. If products and components from other manufacturers are used, these must be recommended or approved by Siemens. Proper transport, storage, installation, assembly, commissioning, operation and maintenance are required to ensure that the products operate safely and without any problems. The permissible ambient conditions must be complied with. The information in the relevant documentation must be observed.

Trademarks

All names identified by ® are registered trademarks of Siemens AG. The remaining trademarks in this publication may be trademarks whose use by third parties for their own purposes could violate the rights of the owner.

Disclaimer of Liability

We have reviewed the contents of this publication to ensure consistency with the hardware and software described. Since variance cannot be precluded entirely, we cannot guarantee full consistency. However, the information in this publication is reviewed regularly and any necessary corrections are included in subsequent editions.

Preface

Purpose of the manual

This manual provides information about programming and operating the SINUMERIK 808D CNC on milling machines.

My Documentation Manager (MDM)

Under the following link you will find information to individually compile your documentation based on the Siemens content:

www.siemens.com/mdm

Target group

This manual is intended for the following audience:

- End users of milling machines installed with SINUMERIK 808D control systems, including operators, programmers and maintenance engineers
- Service engineers of the machine tool manufacturer

Standard scope

This manual only describes the functionality of the standard version. Extensions or changes made by the machine tool manufacturer are documented by the machine tool manufacturer.

Technical support

Hotline:	+86 400-810-4288
Service and Support	<ul style="list-style-type: none"> • China: www.siemens.com.cn/808D • Worldwide: http://support.automation.siemens.com

EC Declaration of Conformity

The EC Declaration of Conformity for the EMC Directive can be found on the Internet at <http://support.automation.siemens.com>

Here, enter the number **15257461** as the search term or contact your local Siemens office.

Documentation components

The SINUMERIK 808D documentation consists of the following components:

- Operating Instructions
 - Mechanical Installation Manual
 - Electrical Installation Manual
 - PLC Subroutines Manual
 - Function Manual
 - Parameter Manual
- Diagnostics Manual
- Commissioning Manual
- Programming and Operating Manual (Turning)
- Programming and Operating Manual (Milling)
- Manual Machine Plus (Turning)
- Online Help for Programming and Operating (Turning)
- Online Help for Programming and Operating (Milling)
- Online Help for Manual Machine Plus (Turning)

Table of contents

	Preface	3
1	Introduction.....	7
1.1	SINUMERIK 808D operator panels	7
1.2	Machine control panels	10
1.3	Coordinate systems	13
1.4	Software interface	17
1.4.1	Screen layout	17
1.4.2	Protection levels.....	20
1.4.3	The help system.....	22
2	Turning on, reference point approach	25
3	Setting-up	27
3.1	Setting up tools	28
3.1.1	Creating a new tool	28
3.1.2	Creating a new cutting edge	29
3.1.3	Entering the tool offsets	30
3.1.4	Activating the tool and starting the spindle	31
3.1.5	Assigning the handwheel	32
3.1.6	Measuring the tool (manually).....	33
3.1.7	Measuring the tool with a probe (auto)	36
3.1.8	Calibrating the tool probe.....	38
3.2	Setting up the workpiece.....	40
3.2.1	Entering / modifying work offsets	40
3.2.2	Measuring the workpiece	41
3.3	Entering / modifying the setting data	44
3.4	Setting the R parameters	47
3.5	Other settings in "JOG" mode.....	48
3.5.1	Setting the relative coordinate system (REL)	49
3.5.2	Face milling	50
3.5.3	Setting the JOG data	52
4	Part programming	53
4.1	Creating files or folders	54
4.2	Editing part programs.....	55
4.3	Managing part programs.....	57
4.4	Calculating contour elements.....	60
4.5	Free contour programming	65
4.5.1	Programming a contour	66
4.5.2	Defining a start point	67

Table of contents

4.5.3	Programming contour element.....	68
4.5.4	Parameters for contour elements.....	71
4.5.5	Specifying contour elements in polar coordinates	75
4.5.6	Cycle support	78
4.5.7	Programming example for milling	78
5	Automatic machining	87
5.1	Performing the simulation	88
5.2	Program control.....	90
5.3	Program test.....	91
5.4	Starting and stopping / interrupting a part program	92
5.5	Executing / reading in a part program from external.....	93
5.6	Machining at a specific point.....	96
6	System.....	99
7	Data backup	101
A	Appendix.....	103
A.1	Pocket calculator.....	103
A.2	Editing Chinese characters	105
	Index.....	107

1

Introduction

1.1 SINUMERIK 808D operator panels

Elements on the PPU (Panel Processing Unit) front

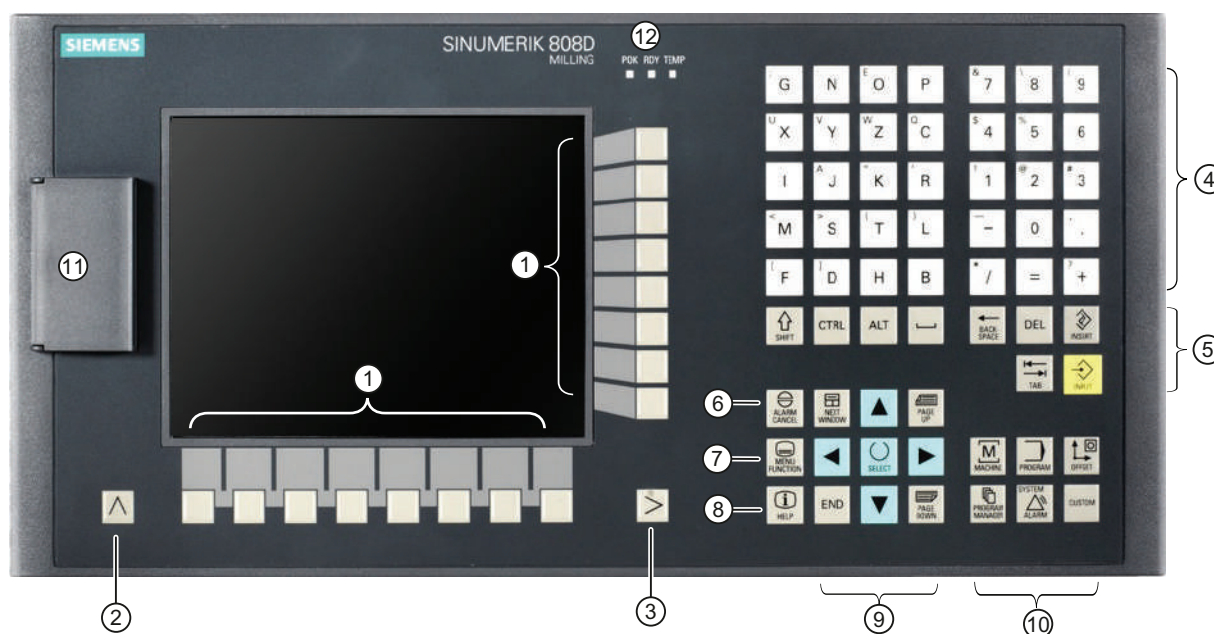













①	Vertical and horizontal softkeys Calls specific menu functions	⑦	On-board assistant key Provides step-by-step guides on basic commissioning and operation procedures
②	Return key Returns to the next higher-level menu	⑧	Help key Calls help information
③	Menu extension key Reserved for future use	⑨	Cursor keys *
④	Alphabetic and numeric keys To enter the upper character on the key, hold down the following key: 	⑩	Operating area keys *
⑤	Control keys *	⑪	USB interface *
⑥	Alarm cancellation key Cancels alarms and messages that are marked with this symbol	⑫	Status LEDs *

* For more information, refer to the table below.

Introduction



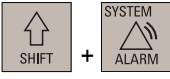





1.1 SINUMERIK 808D operator panels

Further information

Control keys		Deletes a character selected to the left of the cursor
		Deletes the selected file or character
		<ul style="list-style-type: none"> • Indents the cursor by several characters • Toggles between the input field and the selected program name
		<ul style="list-style-type: none"> • Confirms your entry of a value • Opens a directory or program
Cursor keys		Reserved for future use
		Moves the cursor to the end of a line
		Scrolls upwards on a menu screen
		Scrolls downwards on a menu screen
		<ul style="list-style-type: none"> • Toggles between entries in the input field • Enters the "Set-up menu" dialog at NC start-up
Operating area keys		<p>To open the system data management operating area, press the following key combination:</p> 
		<p>Enables user's extension application, for example, to generate user dialogs with the EasyXLanguage function.</p> <p>For more information about this function, refer to the SINUMERIK 808D Function Manual.</p>
Status LEDs		<p>LED "POK"</p> <p>Lights up green: The power supply for the CNC is switched on.</p>
		<p>LED "RDY"</p> <p>Lights up green: The CNC is ready for operation.</p>
		<p>LED "TEMP"</p> <p>Unlit: The CNC temperature is within the specified range.</p> <p>Lights up orange: The CNC temperature is out of range.</p>
USB interface		<p>Connects to a USB device, for example:</p> <ul style="list-style-type: none"> • An external USB memory sticker, to transfer data between the USB sticker and the CNC • An external USB keyboard which functions as an external NC keyboard



Key combinations

Key combination	Description
<ALT> + <X>	Opens the machining operating area: 
<ALT> + <V>	Opens the program editing operating area: 
<ALT> + <C>	Opens the offset parameters operating area: 
<ALT> + 	Opens the program management operating area: 
<ALT> + <M>	Opens the diagnostics operating area 
<ul style="list-style-type: none"> <ALT> + <N>  + 	Opens the system data management operating area: 
<ALT> + <H>	Calls the online help system
<ALT> + <L>	Enables input of lowercase letters
<ALT> + <S>	Applicable only when the user interface language is Chinese Calls the input method editor for entering Chinese characters
<=>	Calls the pocket calculator. Note that this function is not applicable in MDA mode.
<CTRL> + 	Selects text in program blocks
<CTRL> + <C>	Copies the selected text
<CTRL> + <D>	Shows pre-defined slides on the screen
<CTRL> + <P>	Captures screens
<CTRL> + <R>	Restarts the HMI
<CTRL> + <S>	Saves start-up archives

Introduction

1.2 Machine control panels

1.2 Machine control panels



Elements on the MCP (Machine Control Panel) front















①	Emergency stop key Stops all machine motions immediately	⑥	User-defined keys * (all with LED status indicators)
②	Handwheel key (with LED status indicator) Controls the axis movement with external handwheels	⑦	Axis traversing keys *
③	Tool number display Displays the current tool number	⑧	Spindle control keys
④	Operating mode keys (all with LED status indicators)	⑨	Program state keys *
⑤	Program control keys * (all with LED status indicators)	⑩	Feedrate override switch Traverses the selected axis at the specified feedrate override

* For more information, refer to the table below.

Further information

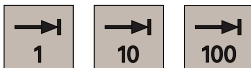
Program control keys		Disables the output of setpoints to axes and the spindle. The control system only "simulates" the traverse movements in order to verify the correctness of the program.
	M01	Stops the program at every block in which miscellaneous function M01 is programmed
	ROV	Adjusts axis feedrate override
		Activates single block execution mode

User-defined keys		Pressing this in any operating mode switches on/off the lamp. LED lit: The lamp is switched on. LED unlit: The lamp is switched off.
		Pressing this key in any operating mode switches on/off the coolant supply. LED lit: The coolant supply is switched on. LED unlit: The coolant supply is switched off.
		When all axes and the spindle stop operation, pressing this key unlocks the safety door. LED lit: The safety door is unlocked. LED unlit: The safety door is locked.
		Pressing this key rotates the magazine clockwise (active only in JOG mode). LED lit: The magazine rotates clockwise. LED unlit: The magazine stops clockwise rotation.
		Pressing this key approaches the magazine to the reference point (active only in JOG mode). LED on: The magazine is reference point approached. LED off: The magazine is not yet referenced
		Pressing this key rotates the magazine counterclockwise (active only in JOG mode). LED on: The magazine rotates counterclockwise. LED off: The magazine stops counterclockwise rotation.
		Pressing this key in any operating mode starts the forward rotation of the chip remover (active only in JOG mode). LED lit: The chip remover starts forward rotation. LED unlit: The chip remover stops rotation.
		Keeping pressing this key in any operating mode rotates the chip remover in reverse order. Releasing the key changes the chip remover to the previous forward rotation or stop state (active only in JOG mode). LED lit: The chip remover starts reverse rotation. LED unlit: The chip remover stops reverse rotation.
Axis traversing keys		Traverses the selected axis at rapid traverse speed while pressing the relevant axis key
		No function is assigned to this key.
		Incremental feed keys (with LED status indicators) Sets increments desired for the axis to traverse
Program state keys		Stops the execution of NC programs
		Starts the execution of NC programs

Introduction

1.2 Machine control panels

	<ul style="list-style-type: none"> Resets NC programs Cancels alarms that meet the cancel criterion
---	---

Pre-defined insertion strips

The MCP (machine control panel) package includes two sets (six pieces each) of pre-defined insertion strips. One set is for the turning version of the control system and is pre-inserted in the back of the MCP. The other set is for the milling version of the control system.

For a milling version of the control system, replace the pre-inserted strips with the milling-specific insertion strips.

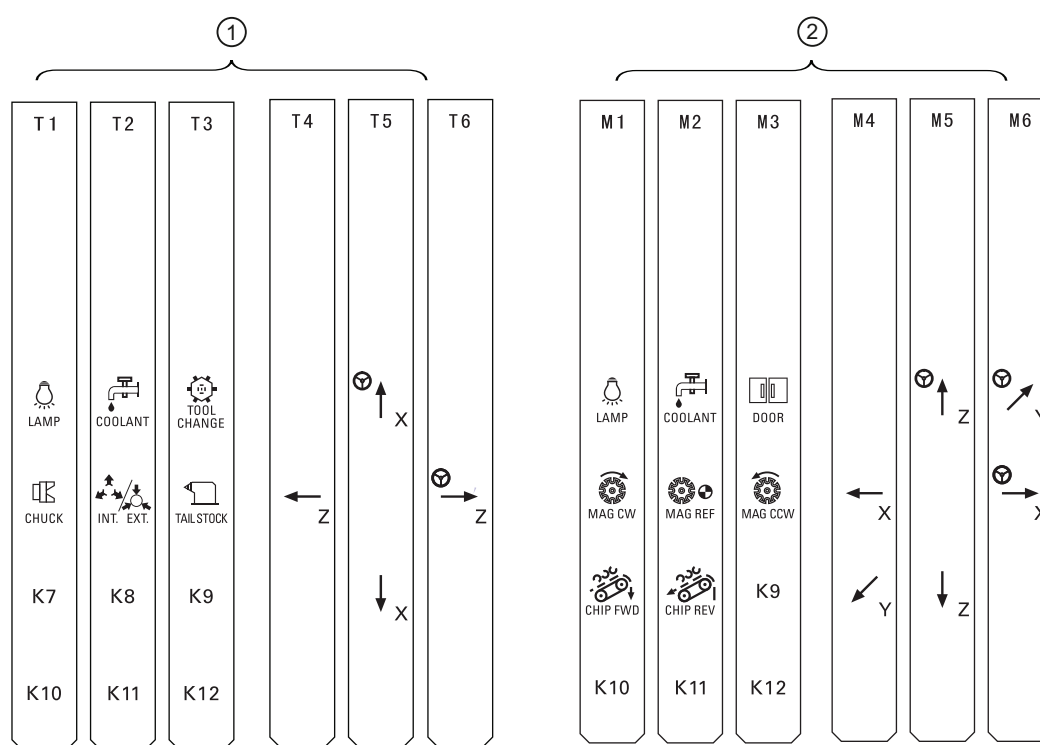

- ① Insertion strips for turning version of the control system
② Insertion strips for milling version of the control system

Customized insertion strips

The MCP package also includes an A4-sized blank plastic sheet with detachable strips. You can customize insertion strips if the pre-defined strips can not meet your needs.

In the \04040000\examples\MCP folder of the Toolbox DVD for the SINUMERIK 808D, there is a symbol library file and an insertion strip template file. To make customized insertion strips, follow the steps below:

- Copy the desired symbols from the symbol library file to the desired locations in the insertion strip template.
- Print the template to the A4-sized blank plastic sheet.



3. Detach the insertion strips from the blank plastic sheet.
4. Pull out the pre-inserted strips from the MCP.
5. Insert the customized strips on the back of the MCP.

Note

This manual assumes an 808D standard machine control panel (MCP). Should you use a different MCP, the operation may be other than described herein.

1.3 Coordinate systems

As a rule, a coordinate system is formed from three mutually perpendicular coordinate axes. The positive directions of the coordinate axes are defined using the so-called "3-finger rule" of the right hand. The coordinate system is related to the workpiece and programming takes place independently of whether the tool or the workpiece is being traversed. When programming, it is always assumed that the tool traverses relative to the coordinate system of the workpiece, which is intended to be stationary.

The figure below illustrates how to determine the axis directions.

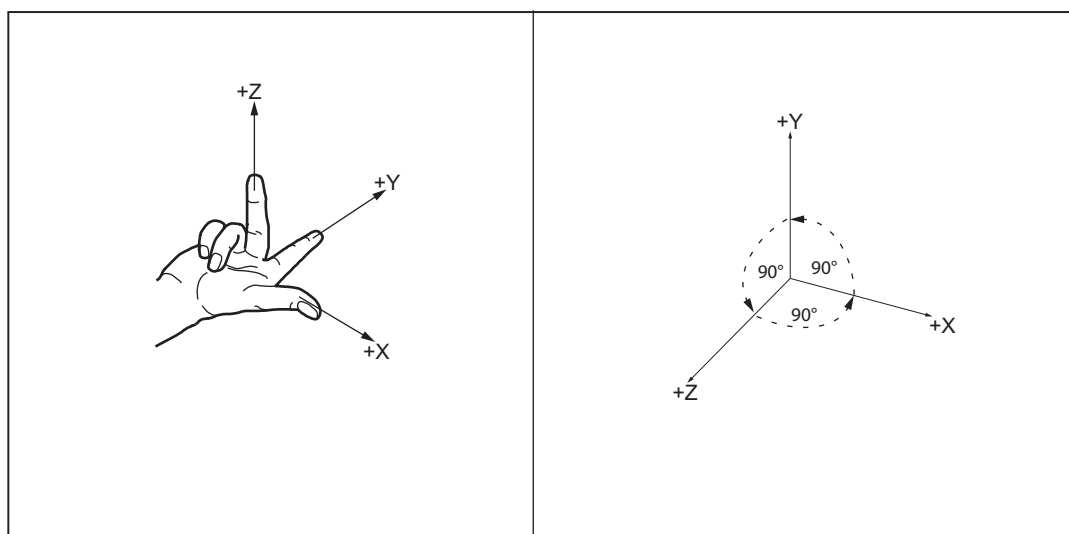

Machine coordinate system (MCS)

The orientation of the coordinate system relative to the machine depends on the respective machine types. It can be rotated in different positions.

The directions of the axes follow the "3-finger rule" of the right hand. Seen from the front of the machine, the middle finger of the right hand points in the opposite direction to the infeed of the spindle.

Introduction

1.3 Coordinate systems

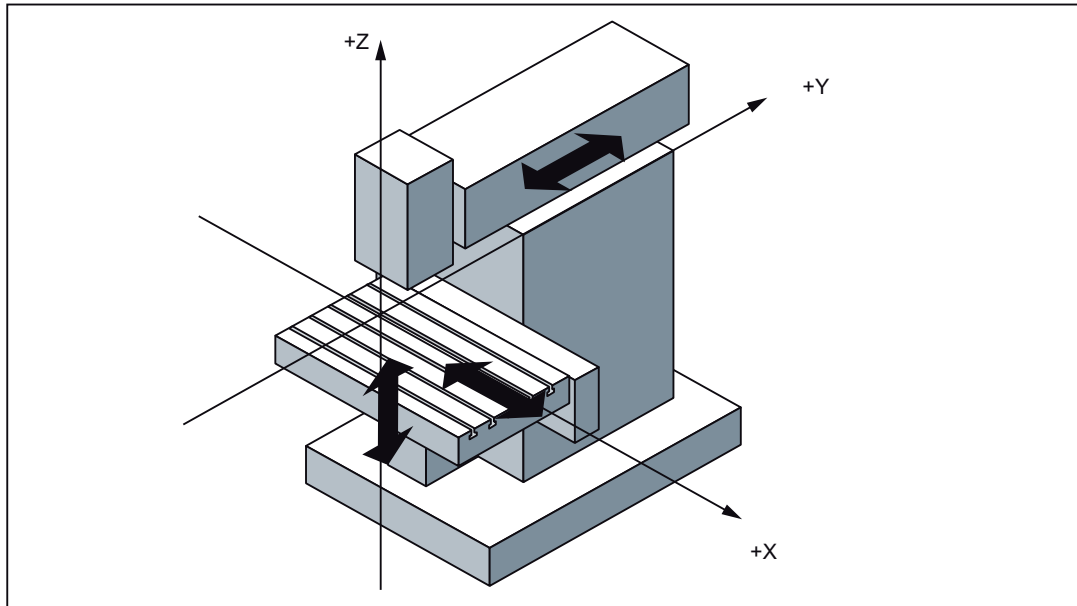

The origin of this coordinate system is the **machine zero**.

This point is only a reference point which is defined by the machine manufacturer. It does not have to be approachable.

The traversing range of the **machine axes** can be in the negative range.

Workpiece coordinate system (WCS)

To describe the geometry of a workpiece in the workpiece program, a right-handed, right-angled coordinate system is also used.

The **workpiece zero** can be freely selected by the programmer in the Z axis. In the X axis, it lies in the turning center.

The figure below shows an example of the workpiece coordinate system.

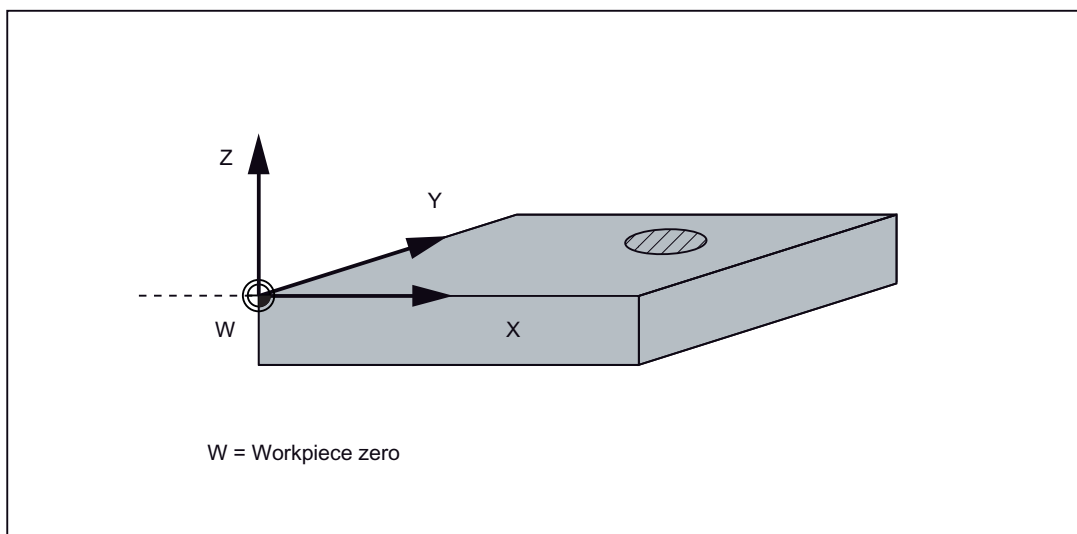

Relative coordinate system (REL)

In addition to the machine and workpiece coordinate systems, the control system provides a relative coordinate system. This coordinate system is used to set reference points that can be freely selected and have no influence on the active workpiece coordinate system. All axis movements are displayed relative to these references.

Clamping the workpiece

For machining, the workpiece is clamped on the machine. The workpiece must be aligned such that the axes of the workpiece coordinate system run in parallel with those of the machine. Any resulting offset of the machine zero with reference to the workpiece zero is determined along the Z axis and entered in a data area intended for the **settable work offset**. In the NC program, this offset is activated during program execution, for example, using a programmed **G54** command.

The figure below shows an example of the workpiece clamped on the machine.

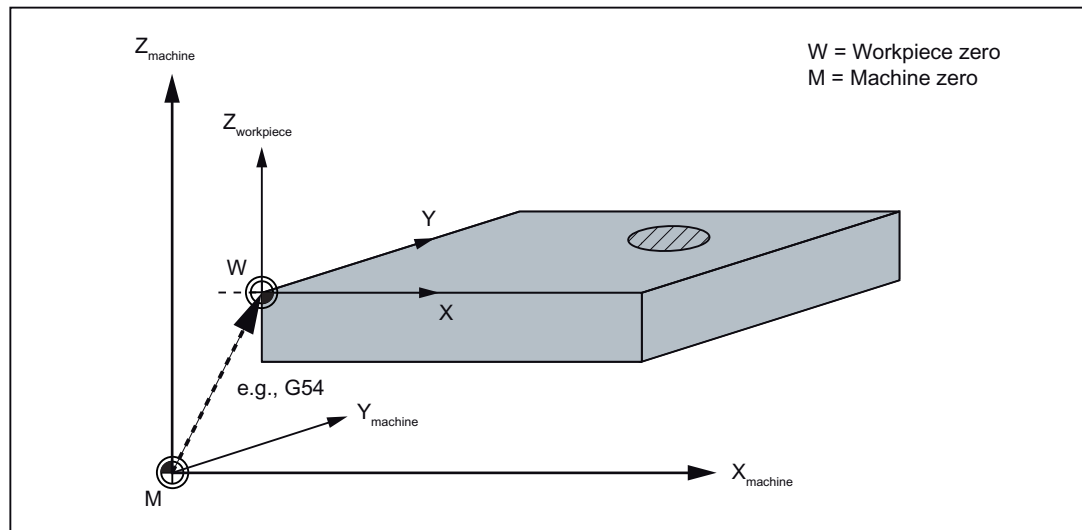

Introduction

1.3 Coordinate systems

Current workpiece coordinate system

The programmed work offset TRANS can be used to generate an offset with reference to the workpiece coordinate system, resulting in the current workpiece coordinate system.

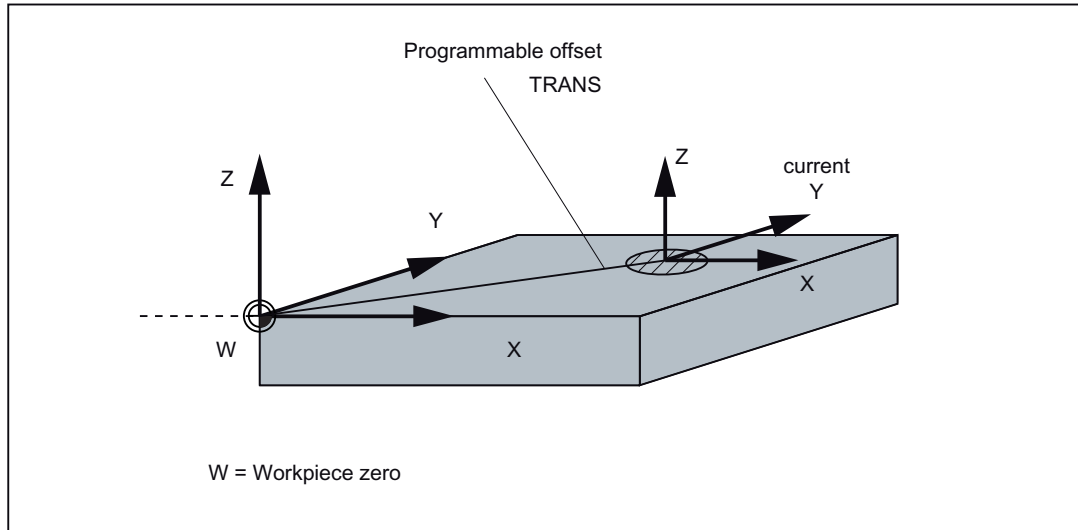

1.4 Software interface

1.4.1 Screen layout

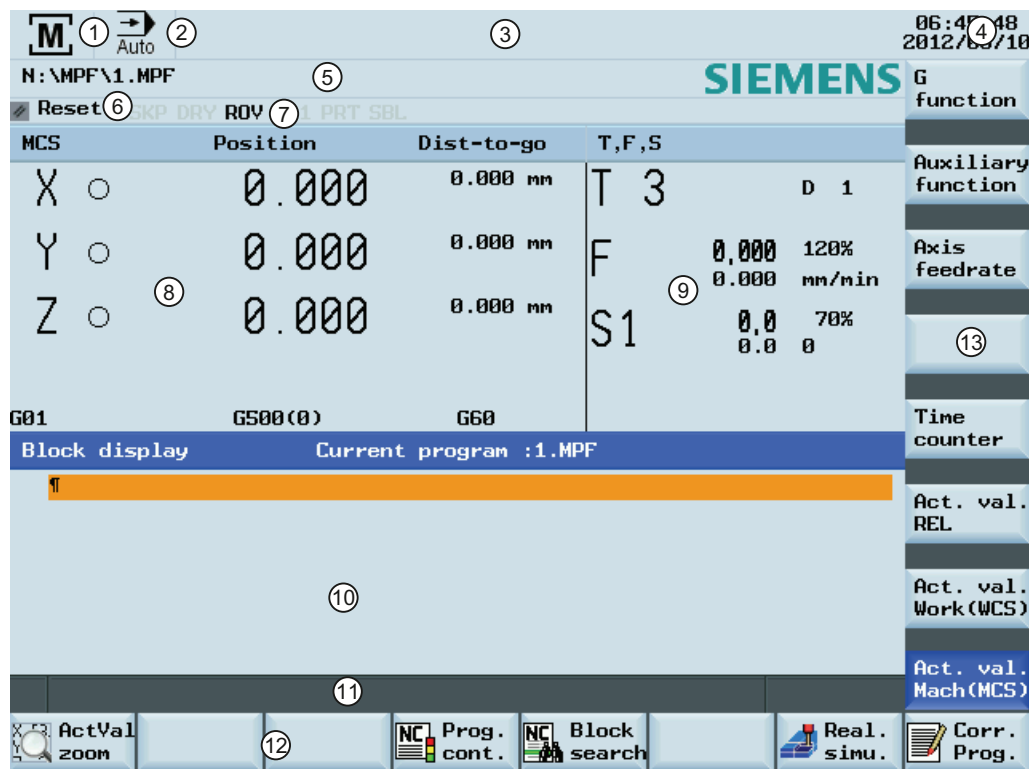

Status area

- ① Active operating area
- ② Active operating mode
- ③ Alarm and message prompt area
- ④ Current time and date
- ⑤ Program file name
- ⑥ Program status indication
- ⑦ Active program control modes

Application area

- ⑧ Actual value window
- ⑨ T, F, S window
- ⑩ Operating window with program block display
- ⑪ Information line
- ⑫ Horizontal softkey bar
- ⑬ Vertical softkey bar









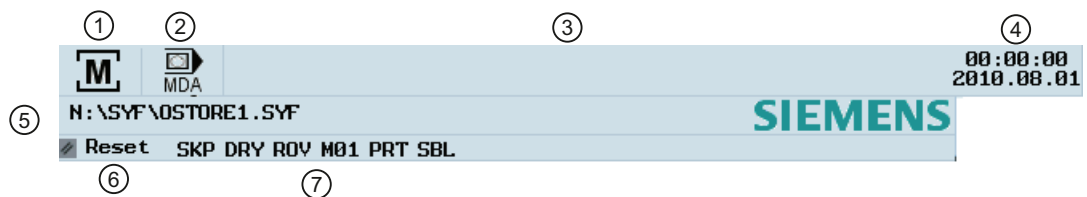



Tip and softkey area

Introduction

1.4 Software interface

Status area





		Display	Meaning
①	Active operating area		Machining operating area
			System data management operating area
			Program editing operating area
			Program management operating area
			Offset parameters operating area
			Diagnostics operating area
②	Active operating mode		"REF POINT" mode
			"JOG" mode
			Incremental traverse in "JOG" mode
			
			
			"MDA" mode
	"AUTO" mode		

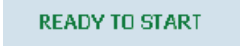

		Display	Meaning
③	Alarms and messages		<p>Displays active alarms with alarm text</p> <p>The alarm number is displayed in white lettering on a red background. The associated alarm text is shown in red lettering.</p> <p>An arrow indicates that several alarms are active. The number to the right of the arrow indicates the total number of active alarms.</p> <p>When more than one alarm is active, the display scrolls through the alarms in sequence.</p> <p>An acknowledgement symbol indicates the alarm cancel criterion.</p>
			<p>Displays messages from NC programs</p> <p>Messages from NC programs do not have numbers and appear in green lettering.</p>
④		Current time and date	
⑤		File name of the current part program	
⑥		Program state	
		RESET	Program canceled / default state
		RUN	Program is running
⑦		STOP	Program stopped
		Program control in "AUTO" mode	

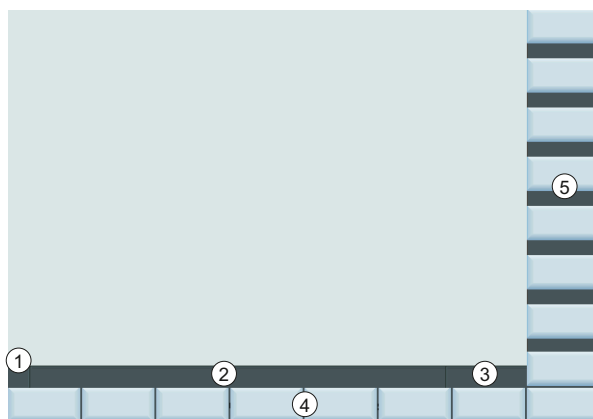

Tip and softkey area



Screen item	Display	Description
①		Return symbol Returns to the next higher-level menu with the following key: 
②		Information line Displays notes and information for the operator and fault states

Introduction

1.4 Software interface

Screen item	Display	Description
③	HMI status information	
		Lowercase letter input active
		RS232 connection active
		Connection to PLC Programming Tool
④		Horizontal softkey bar
⑤		Vertical softkey bar

1.4.2 Protection levels

Protection levels

SINUMERIK 808D provides a concept of protection levels for enabling data areas. Different protection levels control different access rights.

The control system delivered from SIEMENS is set by default to the lowest protection level 7 (without password). If the password is no longer known, the control system must be reinitialized with the default machine data. All passwords are then reset to default passwords for this software release.

NOTICE
Before you boot the control system with default machine data, make sure that you have backed up your data; otherwise, all data is lost after rebooting with the default machine data.

Protection level	Locked by	Area
0	Siemens password	Siemens, reserved
1	Manufacturer password	Machine manufacturers
2	Reserved	
3-6	End-user password (Default password: "CUSTOMER")	End users
7	No password	End users

**Protection level 1**

Protection level 1 requires a manufacturer password. With this password entry, you can perform the following operations:

- Entering or changing all machine data
- Conducting NC commissioning

Protection level 3-6

Protection level 3-6 requires an end-user password. With this password entry, you can perform the following operations:

- Entering or changing part of the machine data
- Editing programs
- Setting offset values
- Measuring tools

Protection level 7

Protection level 7 is set automatically if no password is set and no protection level interface signal is set. The protection level 7 can be set from the PLC user program after you set the bits in the user interface.

In the menus listed below the input and modification of data depends on the set protection level:

- Tool offsets
- Work offsets
- Setting data
- RS232 settings
- Program creation / program correction

You can set the protection level for these function areas with the display machine data (USER_CLASS...).

Introduction

1.4 Software interface

1.4.3 The help system

The SINUMERIK 808D control system provides comprehensive online help. Whenever necessary, you can call the help system from any operating area.

The help system





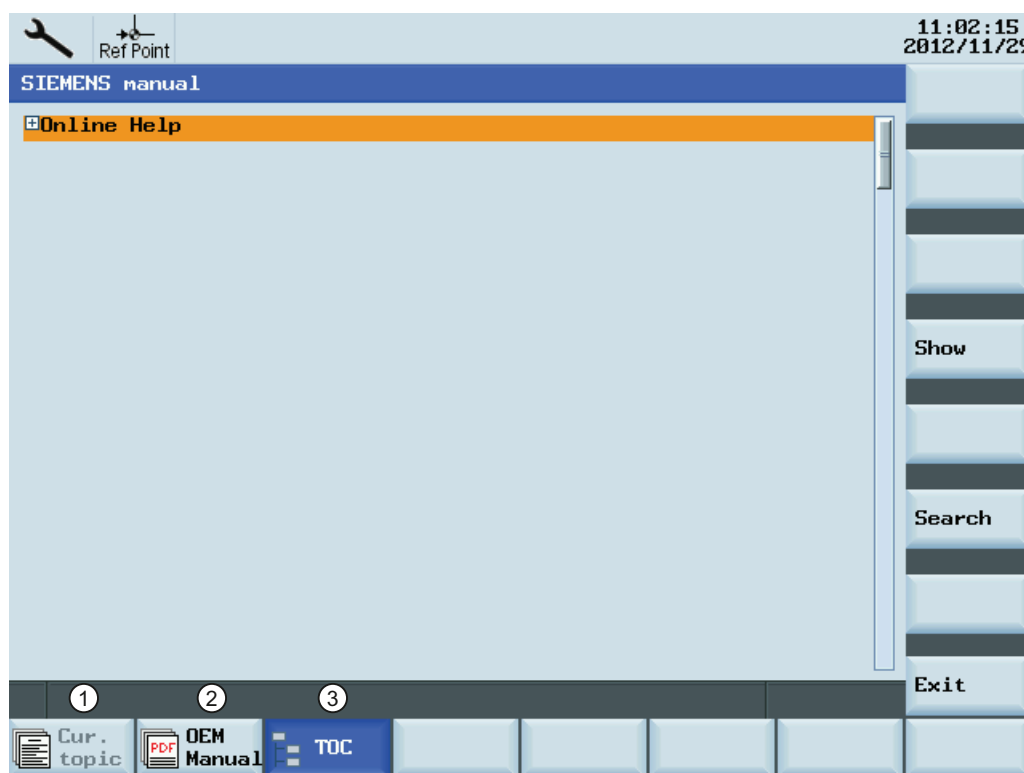

Press this key or the key combination <ALT> + <H> to call the help system from any operating area. If a context-sensitive help exists, Window "①" opens; otherwise, Window "③" opens.



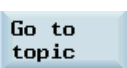





- ① Calls the context-sensitive help for the current topic:
 - Current operating window
 - Alarms selected in the alarm specific operation area
 - Machine data or setting data selected
- ② Calls the OEM-developed PDF manual
- ③ Displays all available help information:
 - Siemens help manuals
 - OEM-developed help manuals, if any



Softkeys in Window "①"

	Use this softkey to select cross references A cross reference is marked by the characters ">> ... <<". Note: This softkey is displayed only if the current page contains a cross reference.
	Searches for a term in the current topic
	Continues search for the next term that matches the search criteria
	Exits the help system

Softkeys in Window "②"







	Zooms in the current view
	Zooms out the current view
	Zooms the current view to page width
	Jumps to the desired page
	Searches for a term in the current topic
	Continues search for the next term that matches the search criteria
	Exits the help system

Softkeys in Window "③"

	Expands hierarchical topics
	Collapses hierarchical topics

Introduction

1.4 Software interface

	Navigates upwards through the hierarchical topics
	Navigates downwards through the hierarchical topics
	Opens the selected topic in the current topic relevant window Functions the same as pressing the following key: 
	Searches for a term in the current topic
	Continues search for the next term that matches the search criteria
	Exits the help system

2

Turning on, reference point approach

Note

When turning on/off the CNC and the machine, also observe the machine tool manufacturer's documentation, since turning on and reference point approach are machine-dependent functions.

Operating sequence

1. Switch on the power supply for the control system and the machine.
2. Release all emergency stop buttons on the machine.

By default, the control system is in the "REF POINT" window after booting.

MCS	Reference point	mm	T,F,S
X ○	0.000	mm	T 0
Y ○	0.000	mm	F 0.0
Z ○	0.000	mm	S1

The symbol ○ shown on the screen indicates that the axis is not yet referenced. If an axis is not referenced, the symbol is always visible in the current (machining) operating area.

3. Press the corresponding axis traversing keys to traverse each axis to the reference point.

If an axis is referenced, a symbol (●) is shown next to the axis identifier and is visible only in the ""REF POINT" window.



MCS	Reference point	mm	T,F,S
X ●	0.000	mm	T 0
Y ●	0.000	mm	F 0.0
Z ●	0.000	mm	S1

Note that axis traversing directions and axis key functions are defined by the machine manufacturer.



Turning on, reference point approach

3

Setting-up

Overview

When working with the CNC, you need to set up the machine and the tools, etc. as follows:

- Create the tools and cutting edges.
- Enter/modify the tool and work offsets.
- Enter the setting data.

Softkey functions

Pressing this key on the PPU allows you to open the following window:

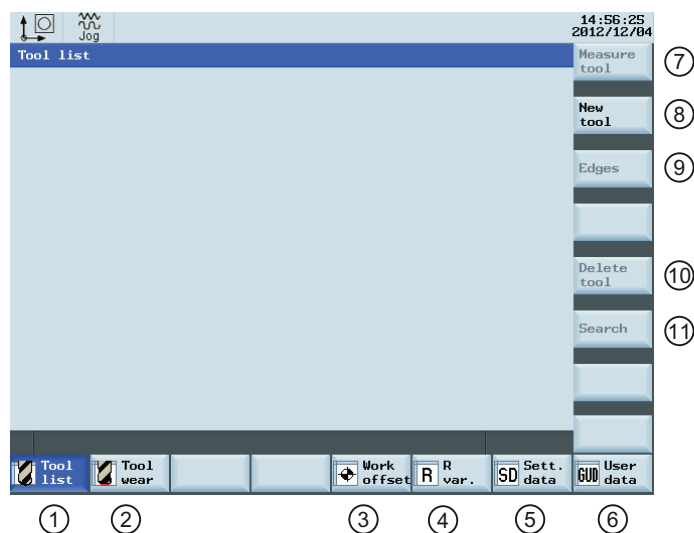

①	Displays and modifies the tool offsets	⑦	Measures the tool manually or automatically
②	Displays and modifies the tool wear data	⑧	Creates a new tool For more info, see Section "Creating a new tool (Page 28)".
③	Displays and modifies the work offsets	⑨	Opens a lower-level menu for cutting edge settings For more info, see Section "Creating a new cutting edge (Page 29)".
④	Displays and modifies the R variables	⑩	Removes the currently selected tool from the tool list
⑤	Configures and displays lists of setting data	⑪	Searches for your desired tool with the tool number
⑥	Displays the defined user data		

Setting-up

3.1 Setting up tools

3.1 Setting up tools

3.1.1 Creating a new tool

Operating sequence



1. Select the desired operating area.



2. Open the tool list window.



3. Open the lower-level menu for tool type selection.

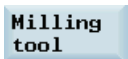

4. Select a desired tool type with the corresponding softkey.



5. Enter the tool number (value range: 1 to 31999; preferably enter a value less than 100) in the following window.

The control system supports a maximum of 64 tools or 128 cutting edges.



6. Use this softkey to confirm your settings. The window below shows the information of the new tool created.

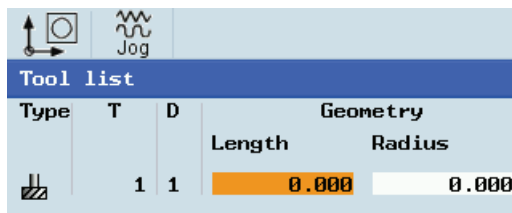

7. Enter the tool radius data.



3.1.2 Creating a new cutting edge

Operating sequence



1. Select the desired operating area.



2. Open the tool list window.



3. Select the tool to which you desire to add a cutting edge.



4. Open the lower-level menu for cutting edge settings.



5. Press this softkey to create a new cutting edge for the selected tool. The control system automatically adds the new cutting edge to the tool list.

Type	T	D	Geometry	
			Length	Radius
	1	1	0.000	0.000
	2	2	0.000	0.000

Note that the machine can be loaded with a maximum of 128 cutting edges, and a maximum of nine cutting edges can be created for each tool.

6. You can enter different lengths and radii for each cutting edge (see Section "Entering tool offsets (Page 30)" for more information).

Other options for setting up the cutting edges:



Reset all offset values of the selected cutting edge to zero

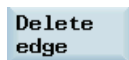

Delete the selected cutting edge

Setting-up

3.1 Setting up tools

3.1.3 Entering the tool offsets

The tool offsets consist of the data describing the geometry, the wear and the tool type. Each tool contains a defined number of cutting edge parameters dependent on the particular tool type. Besides entering the tool offsets in the tool list, you can alternatively determine the tool offsets by measuring the tool.

Operating sequence



1. Select the desired operating area.



2. Open the tool list window, which contains a list of the tools and cutting edges that have been created.

3. Use the cursor keys to navigate in the list.

4. Enter the values as required in the input fields (see table below for the parameter descriptions).



5. Use this key or move the cursor to confirm your entries.

Parameters

The following table lists parameters shown in the tool list window:

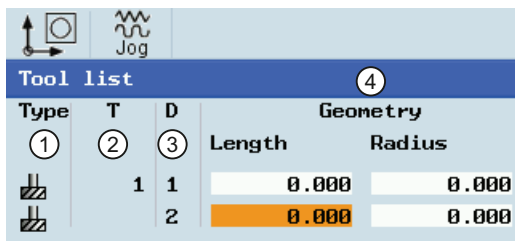

Tool list				
Type	T	D	Geometry	
			Length	Radius
①	②	③	0.000	0.000
			0.000	0.000

① Tool type

③ Cutting edge number

② Tool number

④ Tool length and radius



3.1.4 Activating the tool and starting the spindle

Operating sequence



1. Select the desired operating area.



2. Switch to "JOG" mode.



3. Open the "T, S, M" window.



4. Enter the desired values for the tool number , cutting edge number and spindle speed (for example, T1, D1 and 500 rpm) in the "T, S, M" window.
5. Use this key or move the cursor to confirm your entries.



6. Select the rotation direction of the spindle as required.
 - M3: Spindle rotates clockwise
 - M4: Spindle rotates counterclockwise

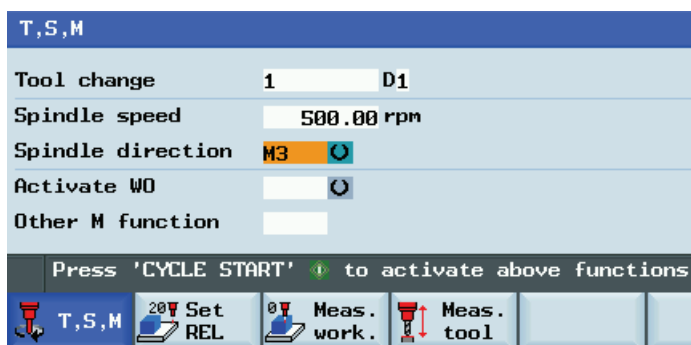

7. Press this key on the MCP to activate the tool and start the spindle.

Setting-up

3.1 Setting up tools

3.1.5 Assigning the handwheel

Operating sequence



1. Select the desired operating area.



2. Press this key on the MCP.



3. Press the desired axis traversing key with the handwheel icon. The handwheel is assigned.



Alternatively, you can assign the handwheels using the softkeys:



1. Select the desired operating area.



2. Open the machine data window.



3. Use this softkey to open the basic machine data list. Search for the general machine data "14512 USER_DATA_HEX[16]" with cursor keys or the following softkey and then set 14512[16].7 = 1.

Search



4. Confirm your input.



5. Press this vertical softkey to activate the value change. Note that the control system restarts to accept the new value.



6. After the control system has booted, select the desired operating area.



7. Press this key on the MCP.



8. Press this vertical softkey to open the handwheel assignment window.



9. Select the desired handwheel number with the cursor left/right key.



10. Press the relevant axis softkey for handwheel assignment or deselection.



The symbol "☑" that appears in the window indicates a handwheel has been assigned to the specific axis.



Axis	Handwheel 1		WCS
	1	2	
X	☑		
Y			
Z			



11. Select the required override increment. The selected axis can now be moved with the handwheel.



3.1.6 Measuring the tool (manually)

Overview

Note

For milling tools, both length and the radius must be determined; for drilling tools (see the following figure), only length must be determined.

You can determine the tool length and radius and diameter by either measuring the tool or entering the values in the tool list (see Section "Entering the tool offsets (Page 30)" for more information).

By using the actual position of point F (machine coordinate) and the reference point, the control system can calculate the offset value assigned to length 1 or the tool radius for the selected axis.

Setting-up

3.1 Setting up tools

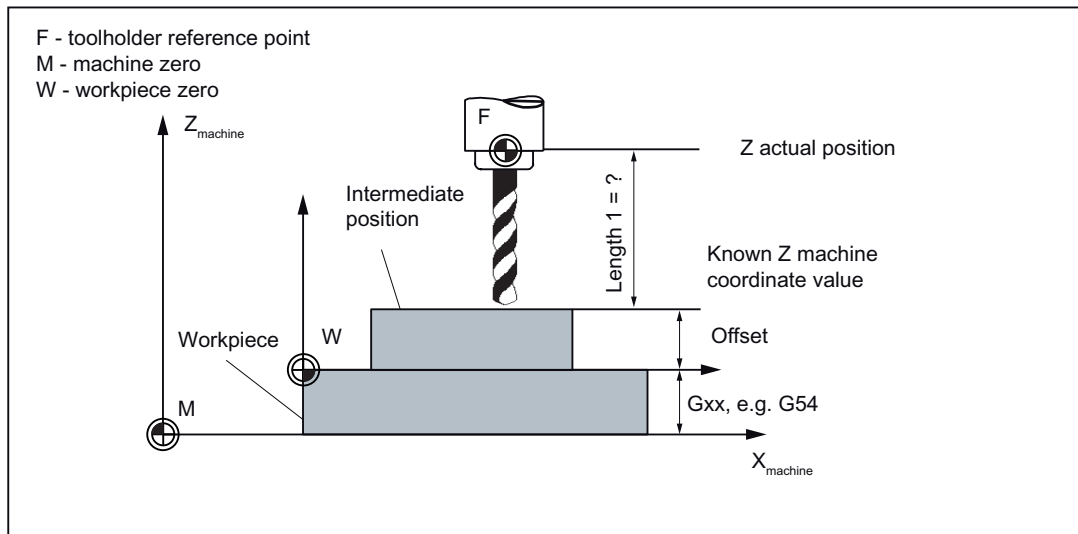

Figure 3-1 Determination of the length offset using the example of a drill 1/Z axis length (milling)

Operating sequence



1. Select the desired operating area.



2. Switch to "JOG" mode.



Open the lower-level menu for tool measurement.



3. Open the manual tool measurement window.



4. Use the axis traversing keys to move the tool to approach the workpiece in the Z direction.

...



5. Switch to "HANDWHEEL" mode.





6. Select a suitable override feedrate, and then use the handwheel to move the tool to scratch the required workpiece edge.

7. Press this key to set the reference point as required (for example, the workpiece).

8. Enter the distance between the tool tip and the reference point in the "ZØ" field (for example, 0 mm).

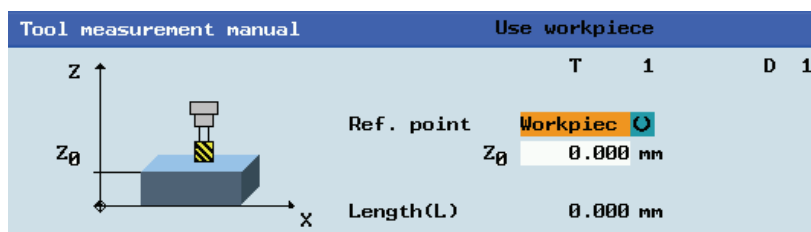

...



9. Save the tool length value in the Z axis. The tool diameter, radius, and cutting edge position are all taken in to account.

10. Press this vertical softkey to open the window for measuring the tool diameter.

11. Use the axis traversing keys to move the tool to approach the workpiece in the X direction.

12. Switch to "HANDWHEEL" mode.

13. Select a suitable override feedrate, and then use the handwheel to move the tool to scratch the required workpiece edge.

Setting-up

3.1 Setting up tools

14. Enter the distance to the workpiece edge in the X and Y directions in the "X \emptyset " and "Y \emptyset " fields respectively.

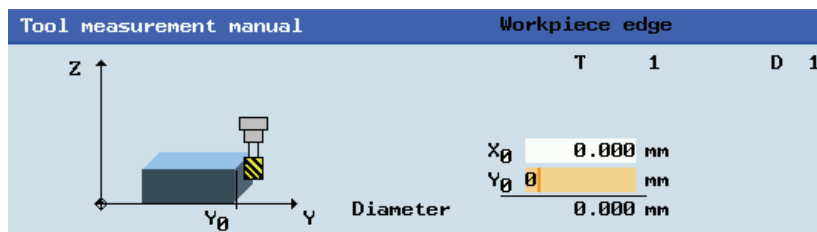

Set
diameter

15. Save the tool diameter value.

Repeat the above operations for other tools and make sure you measure all the tools before machining, which also eases the tool changing process.

3.1.7 Measuring the tool with a probe (auto)

Overview

Automatic tool measuring is used in the standard cycles about the machine data settings. During the automatic measuring, you can determine the tool dimensions in the directions X, Y and Z with a probe.

The preconditions below should be met:

- The machine manufacturer must parameterize special measuring functions for tool probe measuring.
- You must enter the cutting edge position and the radius or diameter of the tool before the actual measurement.
- You must calibrate the probe first (see Section "Calibrating the tool probe (Page 38)" for more information).

Procedure



1. Select the desired operating area.



2. Switch to "JOG" mode.



3. Open the lower-level menu for tool measurement.



4. Open the auto tool measurement window. The tool length in the Z direction is measured by default.

- Change the tool number T or cutting edge number D in the following window if necessary.

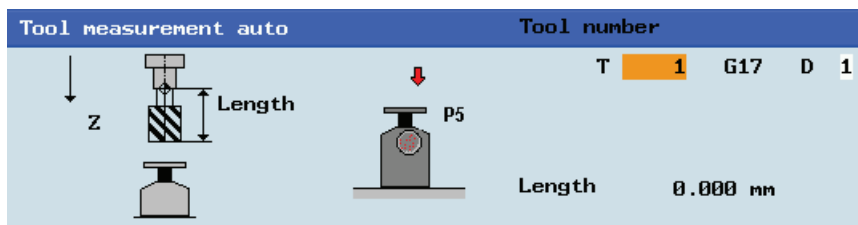

Note:

- Only when you measure the tool without the tool carrier that can be oriented, it is necessary to change the cutting edge number.
- If you change the tool number, you still need to use the "T, S, M" function to change the tool before measurement (refer to Section "Activating the tool and starting the spindle (Page 31)" for more information).

- Manually position the tool in the vicinity of the probe in a way that the collision can be avoided when the probe is traversing.
- Press this key on the MCP. The tool traverses at the measurement feedrate to the probe and gets back. The tool length is calculated and entered in the tool list, with the cutting edge position and tool radius or diameter taken into consideration as well. Note that if several axes move simultaneously, no offset data can be calculated.



- Press this vertical softkey to measure the tool diameter in the X and Y planes.
- Change the tool number T or cutting edge number D in the following window if necessary.

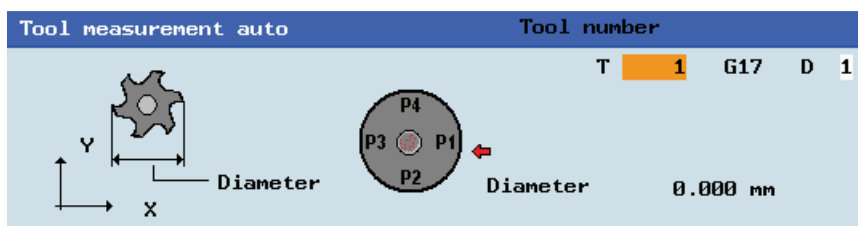

- Manually position the tool in the vicinity of the probe in a way that the collision can be avoided when the probe is traversing.
- Press this key on the MCP. The tool traverses at the measurement feedrate to the probe and get back. The tool diameter is calculated and entered in the tool list. Note that if several axes move simultaneously, no offset data can be calculated.



Setting-up

3.1 Setting up tools

3.1.8 Calibrating the tool probe

Overview

To be able to measure your tools automatically, you must first determine the position of the tool probe based on the machine zero position.

Operating sequences

Setting the probe data



1. Select the desired operating area.



2. Switch to "JOG" mode.



3. Open the lower-level menu for tool measurement.



4. Open the auto tool measurement window.



5. Press this vertical softkey to open the probe data setting window, which shows the coordinates of the probe. Enter the values in the input fields as required (see table below for the parameter descriptions). Refer to the machine coordinate system for all position values.

Probe data			
① Abs. position P5	0.000 mm	⑥ Feedrate	80.000 mm/min
② Center point:X	0.000 mm	⑦ Probe plane	G17
③ Center point:Y	0.000 mm	⑧ Spindle speed	0.000 rpm
④ Diameter	0.000 mm	⑨ Dir. of rotation	M5
⑤ Thickness	0.000 mm	⑩ Safety distance	1.000 mm

- | | |
|--|---|
| ① Absolute position of the probe in Z direction | ⑥ The measurement feedrate in "JOG" mode (this parameter is used to create the measuring program) |
| ② The measured probe center (the machine coordinate) | ⑦ G17, G18 and G19 for selection |
| ③ | ⑧ Spindle speed in r.p.m. |



- | | | | |
|---|--|---|---|
| ④ | The diameter of the probe (the measured value will be shown after calibrating) | ⑨ | Direction of rotation of the spindle: M3, M4, or M5 |
| ⑤ | The thickness of the probe | ⑩ | The minimum distance between the workpiece surface and the workpiece (this parameter is used to create the measuring program) |

Calibrating the probe



1. Select the desired operating area.



2. Switch to "JOG" mode.



3. Open the lower-level menu for tool measurement.



4. Open the auto tool measurement window.

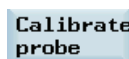

5. Press this vertical softkey to enter the probe calibration screen.

6. Move the calibrating tool until it is approximately over the center of the measuring surface of the tool probe.

You can use the following vertical softkey to choose whether to calibrate the tool length and diameter, or to calibrate the tool length only:

**Length +
diameter**



7. Press this key to start the calibration process.

The calibrating tool traverses automatically at the measurement feedrate to the probe and gets back again. The position of the tool probe is determined and saved in an internal data area.

During the automatic measurement, a dial gauge symbol displays, which indicated that the measuring process is active.



Setting-up

3.2 Setting up the workpiece

3.2 Setting up the workpiece

3.2.1 Entering / modifying work offsets

Functionality

After the machine approaches the reference point, the actual value of the axis coordinate is based on the machine zero (M) of the machine coordinate system. A machining program, however, is always based on the workpiece zero (W) of the workpiece coordinate system. This offset must be entered as the work offset.

Besides measuring the work offsets by scratching the workpiece with the tool, you can also enter the values as required by proceeding through the following steps.

Operating sequence



1. Select the desired operating area.



2. Open the list of work offsets. The list contains the values of the basic offset of the programmed work offset and the active scaling factors, the mirror status display and the total of all active work offsets.
3. Use the cursor keys to position the cursor bar in the input fields to be modified and enter the values.

	X	mm	Y	mm	Z	mm	X	↶	Y	↶	Z	↶
G500		0.000		0.000		0.000		0.000		0.000		0.000
G54		0.000		0.000		0.000		0.000		0.000		0.000
G55		0.000		0.000		0.000		0.000		0.000		0.000
G56		0.000		0.000		0.000		0.000		0.000		0.000
G57		0.000		0.000		0.000		0.000		0.000		0.000
G58		0.000		0.000		0.000		0.000		0.000		0.000
G59		0.000		0.000		0.000		0.000		0.000		0.000
Program		0.000		0.000		0.000		0.000		0.000		0.000
Scale		1.000		1.000		1.000						
Mirror		0		0		0						
Total		0.000		0.000		0.000		0.000		0.000		0.000



4. Confirm your entries. The changes to the work offsets are activated immediately.

3.2.2 Measuring the workpiece

Overview

You have selected the window with relevant work offset (e.g.G54) and the axis you want to determine for the offset.

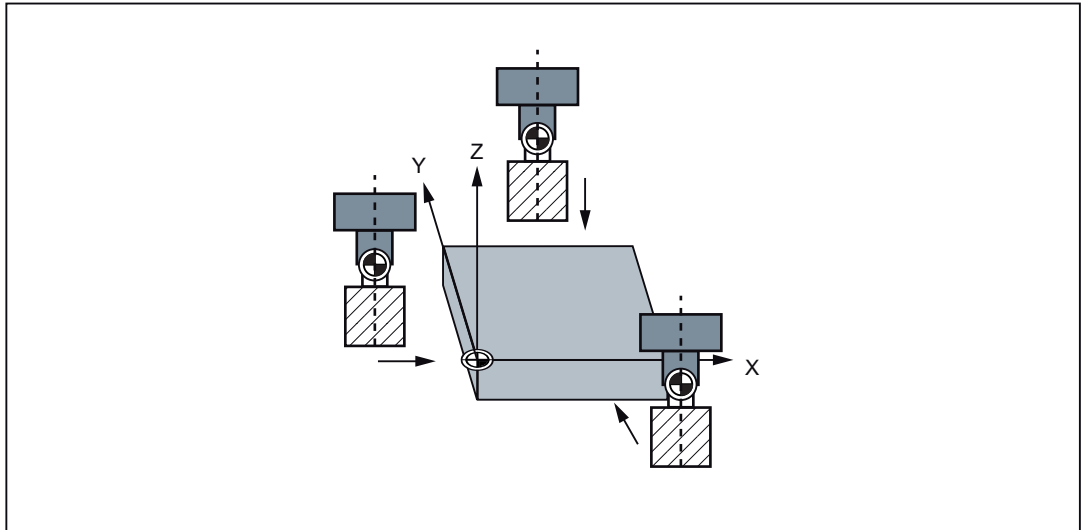

Figure 3-2 Determining the work offset (milling)

Before measuring, you can start the spindle by following the steps in Section "Activating the tool and starting the spindle (Page 31)".

Operating sequences

Workpiece edge measurement



1. Select the desired operating area.



2. Switch to "JOG" mode.



3. Open the lower-level menu for workpiece measurement.



4. Press this vertical softkey to open the window for measurement at the workpiece edge.



5. Press the "X" softkey to measure in the X direction.

Setting-up

3.2 Setting up the workpiece



6. Traverse the tool, which has been measured previously, to approach the workpiece in the X direction.

...



7. Switch to "HANDWHEEL" mode.



8. Select a suitable override feedrate, and then use the handwheel to move the tool to scratch the required workpiece edge.

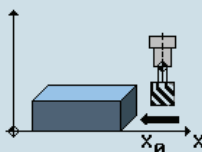

9. Select the offset plane to save in and the measuring direction (for example, "G54" and "-").

Workpiece measurement, edge		Distance to work zero	
	Basic offset -	0.000 mm	Save in G54
	Radius	0.000 mm	Measuring dir. -
	Offset X_0	0.000 mm	Distance 0.000 mm



10. Press this vertical softkey. The work offset of the X axis is calculated automatically and displayed in the offset field.
11. Repeat the above operations to measure and set the work offsets in the "Y" and "Z" axes respectively.

Rectangular workpiece measurement



1. Select the desired operating area.



2. Switch to "JOG" mode.



3. Open the lower-level menu for workpiece measurement.

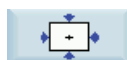

4. Press this vertical softkey to open the window for measurement of a rectangular workpiece.



...



5. Traverse the tool, which has been measured previously, in the direction of the orange arrow P1 shown in the measuring window, in order to scratch the workpiece edge with the tool tip.

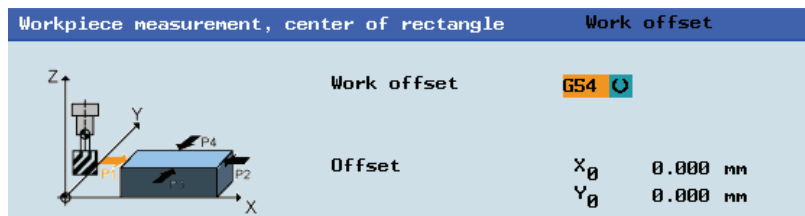

6. Press this vertical softkey to save the tool position P1 in the coordinate system.
7. Repeat Steps 5 and 6 to save the other three positions: P2, P3 and P4.
8. Press this vertical softkey to save the work offsets in the X and Y axes after all four positions are measured.

Circular workpiece measurement



...

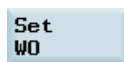

1. Select the desired operating area.
2. Switch to "JOG" mode.
3. Open the lower-level menu for workpiece measurement.
4. Press this vertical softkey to open the window for measurement of a circular workpiece.
5. Traverse the tool, which has been measured previously, in the direction of the orange arrow P1 shown in the measuring window, in order to scratch the workpiece edge with the tool tip.

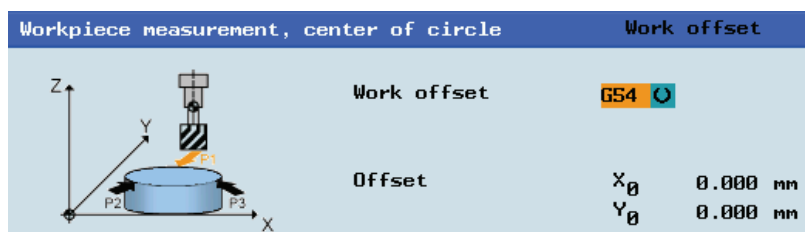

6. Press this vertical softkey to save the tool position P1 in the coordinate system.
7. Repeat Steps 5 and 6 to save the other two positions: P2 and P3.
8. Press this vertical softkey to save the work offsets in the X and Y axes after all three positions are measured.

3.3 Entering / modifying the setting data

Entering/modifying the setting data

Operating sequence



1. Select the desired operating area.



2. Open the setting data window.



3. Position the cursor bar in the input fields to be modified and enter the values (see table below for the parameter descriptions).



4. Use this key or move the cursor to confirm your entries.

Parameters in the setting data window

JOG data		
①	JOG feedrate:	0.000 mm/min
②	Spindle speed:	0.000 rpm
Spindle data		
③	Minimum:	0.000 rpm
④	Maximum:	1000.000 rpm
⑤	Limitation with G96:	100.000 rpm
DRY		
⑥	Dry run feedrate:	5000.000 mm/min
Start angle		
⑦	Start angle for thread:	0.000 °

①	The feedrate in "JOG" mode. If the feedrate value is zero, the control system will use the value stored in the machine data.	⑤	Programmable upper speed limitation at constant cutting rate (G96).
②	The speed of the spindle.	⑥	The feedrate which can be entered here will be used instead of the programmed feedrate in "AUTO" mode if the corresponding function is selected.
③	A limitation of the spindle speed in the Max. (G26) /	⑦	For thread cutting, a start position for the spindle is

④	Min. (G25) fields can only be performed within the limit values defined in the machine data.	displayed as the start angle. A multiple thread can be cut by changing the angle when the thread cutting operation is repeated.
---	--	---

Setting the time counter

Operating sequence



1. Select the desired operating area.



2. Open the setting data window.



3. Open the time counter window.



4. Position the cursor bar in the input fields to be modified and enter the values (see table below for the parameter descriptions).



5. Use this key or move the cursor to confirm your entries.

Parameters in the time counter window

Times / Counter	
①	Parts in total 0
②	Parts required 0
③	Part count 0
④	Run time 0000 H 00 M 00 s
⑤	Cycle time 0000 H 00 M 00 s
⑥	Cutting time 0000 H 00 M 00 s
⑦	Setup time 0019 H 22 M
⑧	Power on time 0000 H 48 M

①	The total number of workpieces produced (total actual)	⑤ The run time of the selected NC program in seconds The default value is 0 each time a new NC program starts up. MD27860 can be set to ensure that this value will be deleted even if there is a jump to the beginning of the program with GOTOS or in the event of ASUBS (used for tool change in "JOG" and "MM+" modes) and PROG_EVENTS starting.
---	--	---

Setting-up

3.3 Entering / modifying the setting data

②	The number of workpieces required (workpiece setpoint)	⑥	Processing time in seconds
③	The number of all workpieces produced since the starting time	⑦	The time since the last control power up with default values ("cold restart") in minutes
④	The total run time of NC programs in "AUTO" mode and the run times of all programs between NC start and end of program / RESET. The timer is set to zero with each power up of the control system.	⑧	The time since the last normal control power up ("warm restart") in minutes

Note: The timer is automatically reset to zero in case of a control power-up with default values.

Modifying miscellaneous setting data

Operating sequence



1. Select the desired operating area.



2. Open the setting data window.



3. Open the window for miscellaneous setting data.



4. Select a group of setting data you desire to modify.

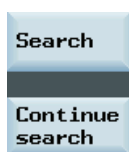
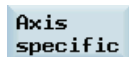

5. Use these softkeys to search for your desired setting data with the data number/name.



6. Position the cursor bar in the input fields to be modified and enter the values.



You can use the following softkeys to switch to the desired axis when modifying the axis-specific setting data.

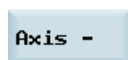
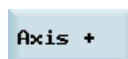

7. Use this key or move the cursor to confirm your entries.





3.4 Setting the R parameters

Operating sequence



1. Select the desired operating area.



2. Open the list of R parameters.
3. Use the cursor keys to navigate in the list, and enter the values in the input fields to be modified.

Note:

You can search for your desired R variable with the following softkey. By default, the function searches the R number.

Search

You can press the following softkey to activate the option of searching by R name. Define the R name as desired, if necessary.

**Show R
name**



4. Use this key or move the cursor to confirm your entries.

Setting-up

3.5 Other settings in "JOG" mode

3.5 Other settings in "JOG" mode

Softkey functions

Pressing  key on the PPU and then  key on the MCP allows you to open the following window:

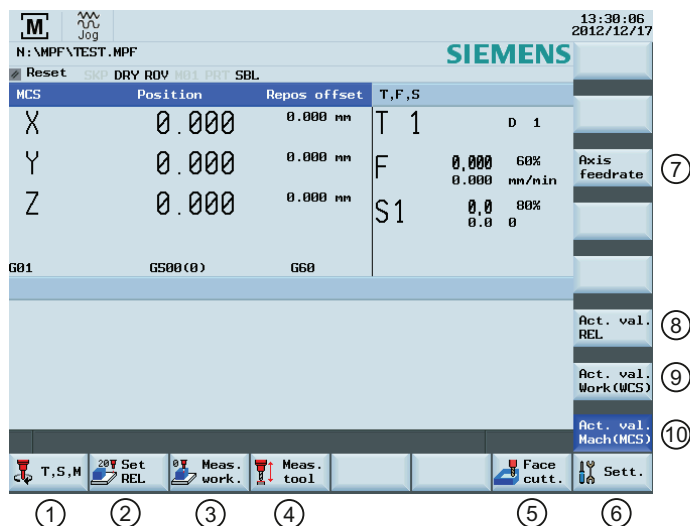

① Opens the "T, S, M" window where you can activate tools, set spindle speed and direction, and select a G code or other M function for activating the settable work offset.	⑥ Opens the settings window where you can set JOG feedrate and variable increment values.
② Switches the display to the relative coordinate system. You can set the reference point in this coordinate system.	⑦ Displays the axis feedrate in the selected coordinate system.
③ Opens the workpiece measurement window where you determine the work offset data. For detailed information about this window, refer to Section "Measuring the workpiece (Page 41)".	⑧ Displays the axis position data in the relative coordinate system.
④ Opens the tool measurement window where you determine the tool offset data. For detailed information about this window, refer to Sections "Measuring the tool (manually) (Page 33)", "Measuring the tool with a probe (auto) (Page 36)" and "Calibrating the tool probe (Page 38)".	⑨ Displays the axis position data in the workpiece coordinate system.
⑤ Opens the face cutting window where you specify parameters for machining the end face or peripheral surface of a blank without creating a special part program. For detailed information about this window, refer to Section "Face milling (Page 50)".	⑩ Displays the axis position data in the machine coordinate system.

Parameters in the "JOG" window

MCS	Position	Repos offset	T,F,S
X	0.000	0.000 mm	T 1 D 1
Y	0.000	0.000 mm	F 0.000 60% 0.000 mm/min
Z	0.000	0.000 mm	S1 0.0 80% 0.0 0

①	Displays the axes that exist in the machine coordinate system (MCS), workpiece coordinate system (WCS), or relative coordinate system (REL). If you traverse an axis in the positive (+) or negative (-) direction, a plus or minus sign appears in the relevant field. If the axis is already in the required position, no sign is displayed.	④	Displays the currently active tool number T with the current cutting edge number D.
②	Displays the current position of the axes in the selected coordinate system.	⑤	Displays the actual axis feedrate and the setpoint (mm/min or mm/rev).
③	Displays the distance traversed by each axis in "JOG" mode from the interruption point in the condition of program interruption. For detailed information about program interruption, refer to Section "Starting and stopping / interrupting a part program (Page 92)".	⑥	Displays the actual value and the setpoint of the spindle speed (r.p.m.).

3.5.1 Setting the relative coordinate system (REL)

Operating sequence



1. Select the desired operating area.



2. Switch to "JOG" mode.



3. Press this softkey to switch the display to the relative coordinate system.



4. Use the cursor keys to select the input field, and then enter the new position value of the reference point in the relative coordinate system.



REL	Position	Repos offset
X	-0.018	0.000 mm
Y	4.843	0.000 mm
Z	-3.600	0.000 mm

Setting-up

3.5 Other settings in "JOG" mode



- Use this key or move the cursor to confirm your entries.
You can use the following vertical softkeys to set the reference point to zero:



Set the X axis to zero



Set the Y axis to zero

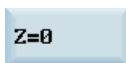

Set the Z axis to zero



Set the spindle to zero

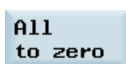

Set all axes to zero

3.5.2 Face milling

Functionality

Use this function to prepare a blank for the subsequent machining without creating a special part program.

Operating sequence



- Select the desired operating area.



- Switch to "JOG" mode.



- Open the face milling window.

- Move the cursor keys to navigate in the list and enter the desired values for the selected parameters (see table below for the parameter descriptions).



- Confirm your entries with the appropriate key.



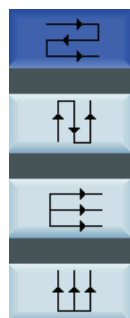

6. Select the cutting path of the tool during machining.



7. Use this softkey to confirm your settings. The system now automatically creates the part program.



8. Press this key on the MCP to run the part program.

Parameters for face milling

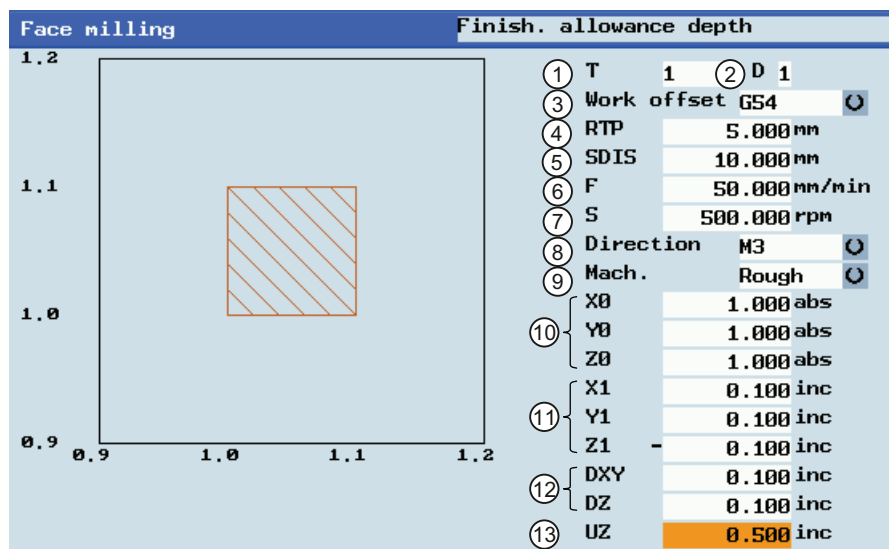

- | | |
|-------------------------------|---|
| ① Tool number | ⑧ Direction of spindle rotation |
| ② Cutting edge number | ⑨ Machining type selection: roughing or finishing |
| ③ Work offset to be activated | ⑩ X\Y\Z position of the blank |
| ④ Retraction plane | ⑪ Cutting dimension in the X\Y\Z direction, specified in increments |
| ⑤ Safety distance | ⑫ Cutting length in the X\Y\Z direction, specified in increments relative to the workpiece edge |
| ⑥ Path feedrate | ⑬ Stock allowance in the Z direction |
| ⑦ Spindle speed | |

Setting-up

3.5 Other settings in "JOG" mode

3.5.3 Setting the JOG data

Operating sequence



1. Select the desired operating area.



2. Switch to "JOG" mode.



3. Press this horizontal softkey to open the following window:



4. Enter values in the input fields and confirm your entries.

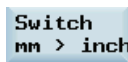

5. If necessary, press this vertical softkey to switch between the metric and inch dimension systems.



Press this softkey to confirm your change.



Press this softkey to exit.

4

Part programming

Softkey functions



Pressing this key on the PPU allows you to open the following window:

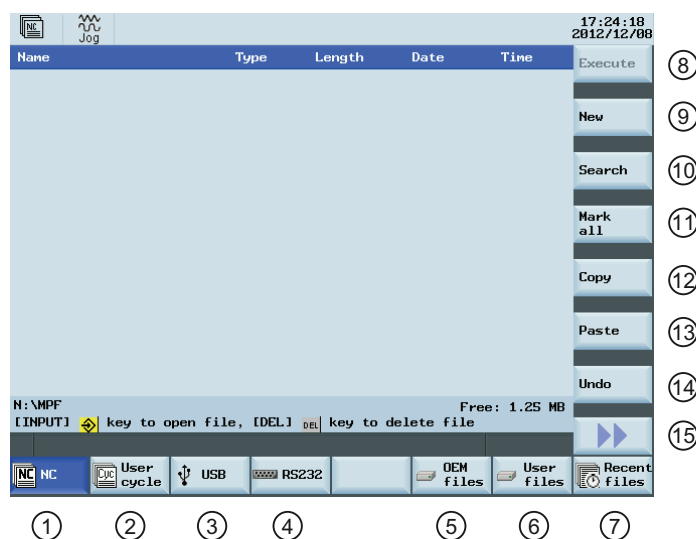

- | | |
|---|---|
| ① Stores the NC programs for subsequent operations | ⑨ Creates new files or directories |
| ② Manages and transfers OEM cycles | ⑩ Searches for files |
| ③ Reads in/out files via the USB drive and executes the program from the external storage media | ⑪ Selects all files for the subsequent operations |
| ④ Reads in/out files via the RS232 interface and executes the program from the external PC/PG | ⑫ Copies the selected file(s) to the clipboard |
| ⑤ Backs up manufacturer files | ⑬ Pastes the selected file(s) from the clipboard to the current directory |
| ⑥ Backs up user files | ⑭ Restores the deleted file(s) |
| ⑦ Shows the recently accessed files | ⑮ Opens the second-level softkeys, for example: |
| ⑧ Executes the selected file. No editing is allowed in the execution process | |

Rename

4.1 Creating files or folders

Creating a part program

To create a part program, follow these steps:



1. Select the desired operating area.



2. Enter the folder for the new program to be created.

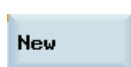

3. Press this vertical softkey.



4. Press this softkey to activate the window for creating a new program.

5. Enter the name of the new program. If you desire to create a main program, it is unnecessary to enter the file extension ".MPF". If you desire to create a subprogram, you must enter the file extension ".SPF". The character length of a program name is limited to 24 English characters or 12 Chinese characters. It is recommended that you do not use any special characters in the program name.



6. Press this softkey to confirm your entry, and the new part program editor window opens subsequently. Enter the blocks in the window, which are saved automatically. The new program is created successfully.

Creating a program directory

To create a program directory, follow these steps:



1. Select the desired operating area.



2. Enter a desired folder for the new directory to be created.

3. Press this vertical softkey.



4. Press this softkey to activate the window for creating a new program directory.



5. Enter the name of the new directory and press this softkey to confirm.



4.2 Editing part programs

Overview

A part program or sections of a part program can only be edited if currently not being executed.

Operating sequence



1. Select the desired operating area.



2. Enter the program directory.









3. Use this softkey or the cursor keys to select the program file to be edited.



4. Press this key to open the program file. The system switches over to the program editor window.

5. Edit the blocks in the window as required (see table below for the descriptions of editing options). Any program changes are automatically stored.

Block editing options

	Replaces the block number from the current cursor to the program end
	Searches for strings
	Selects the text segment before the cursor
	Copies the text segments
	Pastes the text segments
	Delete a text segment
	

Part programming

4.2 Editing part programs

Searching for strings

Proceed through the following steps to search for strings:



1. Press this softkey in the opened program editor window.



2. Press this softkey to search via text. Alternatively, you can search with a given line number by pressing the following softkey:

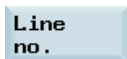

2. Enter the search text or line number in the input field, and press this key to select a starting point for search.



4. Press this softkey to start the search, or otherwise, press the following softkey to cancel the search:



Copying and pasting blocks

Proceed through the following steps to copy and paste blocks:



1. Press this softkey in the opened program editor window to insert a marker.

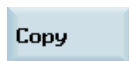

2. Use the cursor keys to select the desired program blocks.
3. Press this softkey to copy the selection to the buffer memory.



4. Place the cursor on the desired insertion point in the program and press this softkey.

The data is successfully pasted.

Editing part programs in "MDA" mode in the machining area

In "MDA" mode, you can create new programs or load existing programs from directories on the control system.

Proceed through the following steps to edit part programs:



1. Select the desired operating area.



2. Switch to "MDA" mode.



- Use the relevant keys on the NC keyboard to enter one or several blocks in the MDA window to create a new part program.

Alternatively, press the following softkey to load an existing part program from a system directory and edit the blocks in the MDA window:



After you finish editing, you can perform further operations as follows:



Execute the program blocks displayed in the MDA window.

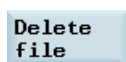

Delete the current program.

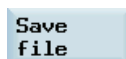

Opens the file saving window where you can specify a name and a storage medium for your current program.

To save your program, either enter a new program name in the input field or select an existing program for overwriting.

4.3 Managing part programs

Searching for programs



- Select the desired operating area.



- Select the storage medium in which you wish to perform the search.



- Press this vertical softkey to open the search window.

- Enter the complete name with extension of the program file to be searched in the first input field in the search window. To narrow your search, you can enter the desired text in the second field.

Part programming

4.3 Managing part programs



5. Use this key to choose whether to include subordinate folders or observe upper / lower case.



6. Press this softkey to start the search, or otherwise, press the following softkey to cancel the search:



Copying and pasting programs



1. Select the desired operating area.

2. Choose the desired storage location and position the cursor on the file or directory which you would like to copy.



3. Press this softkey to copy the selected file or directory.



4. Select the target directory and press this softkey. The file or directory from the clipboard is pasted to the current directory.

Deleting and restoring programs



1. Select the desired operating area.

2. Choose the desired storage location and position the cursor on the file or directory which you would like to delete.



3. Press this key, and the following message appears on the screen:

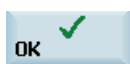
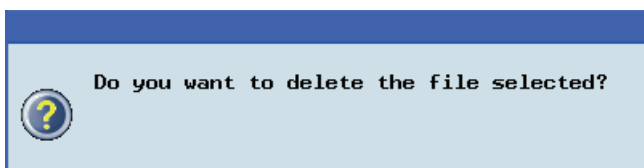

4. Press this softkey to confirm the deletion, or press the following softkey to cancel:



If you want to restore the last deleted file, press the following softkey:

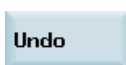



Renaming programs



1. Select the desired operating area.



2. Choose the desired storage location and position the cursor on the file or directory which you would like to rename.



3. Press the extension softkey to access more options.



4. Press this vertical softkey to open the window for renaming.

5. Enter a desired new name with the extension in the input field.

6. Press this softkey to confirm your entry, or press the following softkey to cancel:



Viewing and executing recent programs



1. Select the desired operating area.



2. Press this softkey to open the list of recent files. Note that even the deleted files are also displayed in the list.



3. Position the cursor on a file and press this vertical softkey to start executing the program.

Alternatively, you can press the following key to open the program file for editing:



To clear the current file list, press the following softkey:



4.4 Calculating contour elements

Function

You can use the calculator to calculate the contour elements in the respective input screens.

Calculating a point in a circle



1. Activate the calculator when you are in any input screen.



2. Open the lower-level menu for contour elements selection.



3. Select the desired calculation function.

G2/G3

Press this softkey to define the direction of rotation of the circle.

4. Enter the circle center, the angle of the tangent and the circle radius in the following window:

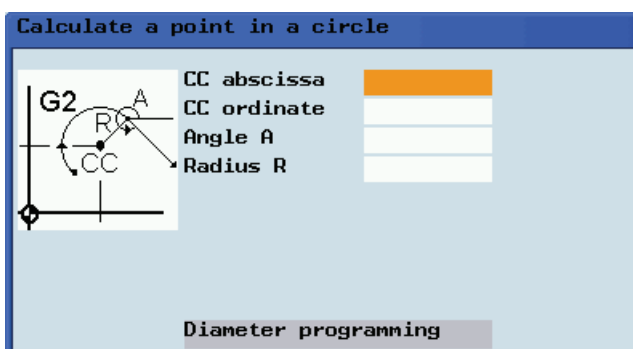

5. Press this softkey to calculate the abscissa and ordinate values of the point.

The abscissa is the first axis, and the ordinate is the second axis of the plane. The abscissa value is displayed in the input field from which the calculator function has been called, and the value of the ordinate is displayed in the next input field. If the function is called from the part program editor, the coordinates are saved with the axis names of the selected basic plane.



Example

Example: Calculating the point of intersection between the circle sector ① and the straight line ② in plane G17.

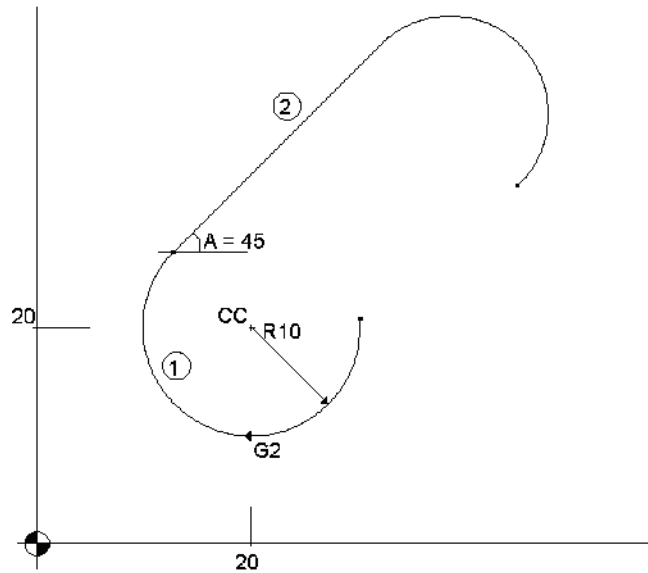

Figure 4-1 Example 1

Given: Radius: 10

Circle center point CC: Y=20 X=20

Connection angle for straight lines: 45°

Calculate a point in a circle

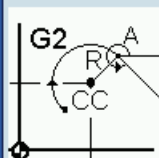
	<table style="width: 100%; border-collapse: collapse;"> <tr> <td style="border: 1px solid #ccc;">CC abscissa</td> <td style="border: 1px solid #ccc;">20</td> </tr> <tr> <td style="border: 1px solid #ccc;">CC ordinate</td> <td style="border: 1px solid #ccc;">20</td> </tr> <tr> <td style="border: 1px solid #ccc;">Angle A</td> <td style="border: 1px solid #ccc;">45</td> </tr> <tr> <td style="border: 1px solid #ccc;">Radius R</td> <td style="border: 1px solid #ccc; background-color: #f9b24d;">10</td> </tr> </table>	CC abscissa	20	CC ordinate	20	Angle A	45	Radius R	10
CC abscissa	20								
CC ordinate	20								
Angle A	45								
Radius R	10								

Radius programming

Result: Y = 27.071

X = 12.928

The result appears on the input screen.

Part programming

4.4 Calculating contour elements

Calculating a point in a plane



1. Activate the calculator when you are in any input screen.



2. Open the lower-level menu for contour elements selection.



3. Select the desired calculation function.

4. Enter the following coordinates or angles in the respective input fields:

- Coordinates of the given point (PP)
- Slope angle of the straight line (A1)
- Distance of the new point with reference to PP
- Slope angle of the connecting straight line (A2) with reference to A1



5. Press this softkey to calculate the abscissa and ordinate values of the point.

The abscissa is the first axis, and the ordinate is the second axis of the plane. The abscissa value is displayed in the input field from which the calculator function has been called, and the value of the ordinate is displayed in the next input field. If the function is called from the part program editor, the coordinates are saved with the axis names of the selected basic plane.

Calculating the Cartesian coordinates



1. Activate the calculator when you are in any input screen.



2. Open the lower-level menu for contour elements selection.



3. Select the desired calculation function.

This function converts the given polar coordinates into Cartesian coordinates.

4. Enter the reference point, the vector length and the slope angle in the respective input fields.



5. Press this softkey to calculate the Cartesian coordinates.

The abscissa value is displayed in the input field from which the calculator function has been called, and the value of the ordinate is displayed in the next input field. If the function is called from the part program editor, the coordinates are saved with the axis names of the selected basic plane.



Calculating the end point



1. Activate the calculator when you are in any input screen.

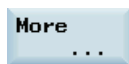

2. Open the lower-level menu for contour elements selection.



3. Select the desired calculation function.

This function calculates the missing end point of the straight line/straight line contour section whereby the second straight line stands vertically on the first straight line.



Press this softkey to define the given end point when the ordinate value is given.



Press this softkey to define the given end point when the abscissa value is given.



Press this softkey to define the second straight line which is rotated counter-clockwise by 90 degrees against the first straight line.



Press this softkey to define the second straight line which is rotated clockwise by 90 degrees against the first straight line.

4. Enter the PP coordinates, angle A, EP abscissa / ordinate, and L length in the respective input fields. The following values of the straight line are known:

Straight line 1: Starting point and slope angle

Straight line 2: Length and one end point in the Cartesian coordinate system



5. Press this softkey to calculate the missing end point.

The abscissa value is displayed in the input field from which the calculator function has been called, and the value of the ordinate is displayed in the next input field. If the function is called from the part program editor, the coordinates are saved with the axis names of the selected basic plane.

Part programming

4.4 Calculating contour elements

Example

The following drawing must be supplemented by the value of the center circle point in order to be able to calculate the point of intersection between the circle sector of the straight lines.

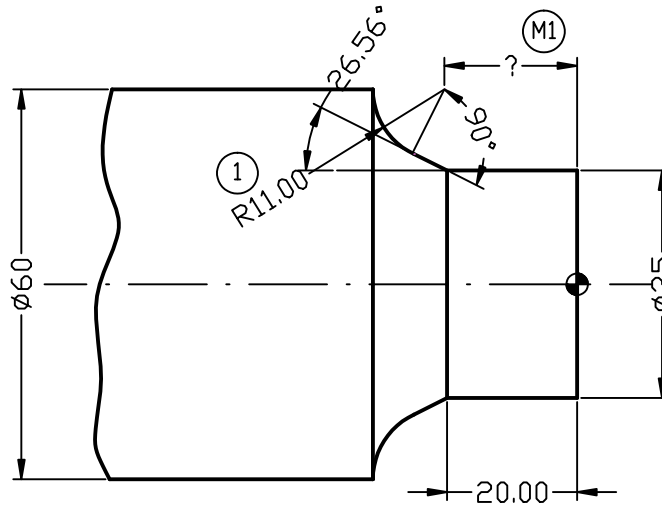
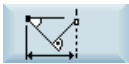

Figure 4-2 Calculation of M1



The missing center point coordinate is calculated using the calculator function, as the radius at the tangential transition is perpendicular to the straight line.

The radius is located at an angle of 90° clockwise to the straight-line defined by the angle.



Use this softkey to select the appropriate direction of rotation.



Use this softkey to define the given end point.

Enter the coordinates of the pole, the slope angle of the straight line, the ordinate of the end point and the circle radius as the length.

Result: $X = -19.499$

$Y = 30$



4.5 Free contour programming

Functionality

Free contour programming enables you to create simple and complex contours.

A contour editor (FKE) calculates any missing parameters for you as soon as they can be obtained from other parameters. You can link together contour elements and transfer to the edited part program.

Contour editor (FKE)

Proceed through the following steps to open the contour editor window:



1. Select the desired operating area.



2. Enter the desired program folder.

3. Select a program file, and press this key to open it in the program editor.



4. Press this softkey to open the contour editor window.

Initially, you define a contour starting point (see Section "Defining a starting point").

The contour is then programmed step-by-step (see Section "Programming example for milling").

Softkey functions

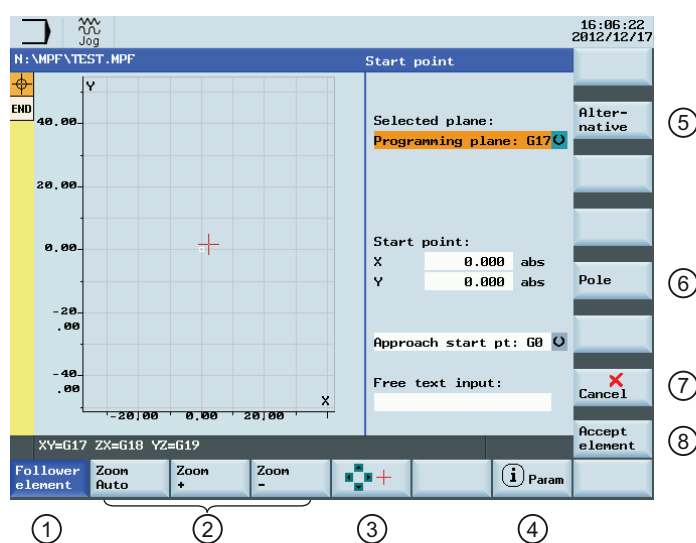

Part programming

4.5 Free contour programming

①	An element was selected using the cursor keys. This softkey enlarges the image section of the selected element.	⑤	Press this softkey to toggle between the selections. This softkey functions the same as pressing the following key: 
②	Zooms the graphic in / out / automatically.	⑥	Defines a pole for contour programming in polar coordinates. The pole can only be entered in absolute Cartesian coordinates.
③	When you select this softkey, you can move the red cross-hair with the cursor keys and choose a picture detail to display. When you deactivate this softkey, the input focus is positioned in the contour chain again.	⑦	Exits the contour editor and returns to the program editor window, without transferring the last edited values to the main program.
④	If you press this softkey, help graphics are displayed in addition to the relevant parameter. Pressing the softkey again exits the help mode.	⑧	Saves the settings for the start point.

4.5.1 Programming a contour

Operating sequence



1. Select the desired operating area.



2. Select this softkey.



3. Select a program with cursor keys.

4. Press this key to open the program.



5. Press this softkey to open the contour editor.

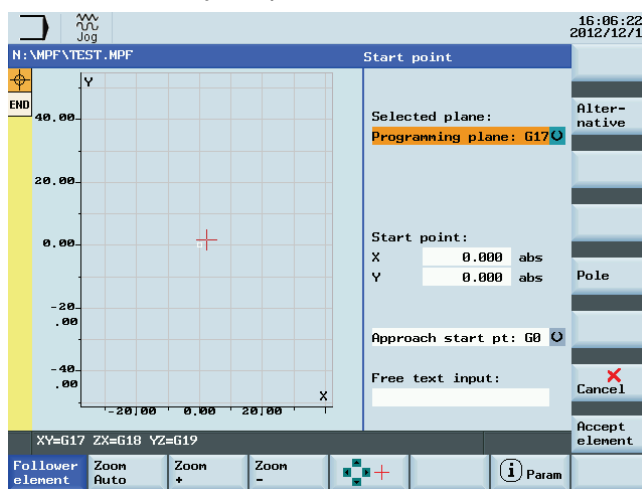

You will find a guide to defining the start point in Section "Defining a start point (Page 67)".



Recompile



When the program edited in the contour editor is opened in the program editor, if you position the editor cursor in a command line of the contour program and then press this softkey, the main screen of the contour editor opens and you can recompile the existing contour.

Note

When recompiling, only the contour elements that were generated in the contour editor are created again. Any changes you made directly in the program text are lost; however, you can subsequently insert and edit user-defined texts, which will not be lost.

4.5.2 Defining a start point

When entering a contour, begin at a position which you already know and enter it as the starting point.

Operating sequence



1. Select the desired operating area.

2. Enter the desired program folder.



3. Select a program file, and press this key to open it in the program editor.



4. Press this softkey to open the contour editor window.

5. Use the cursor keys on the PPU to switch between different input fields.

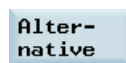

6. Press this softkey or the following key to toggle between the selections.



Enter the desired values as required.

You can also define a pole for contour programming in polar coordinates by pressing the following softkey:

Pole

The pole can also be defined or redefined at a later time. The programming of the polar coordinates always refers to the pole that was defined last.



7. Save the settings for the start point.



Pressing this softkey cancels the settings and exits the contour editor.

4.5.3 Programming contour element

Functionality

Accept element

Once you have defined the contour start point, press this softkey and you can begin programming the individual contour elements from the main screen shown below:

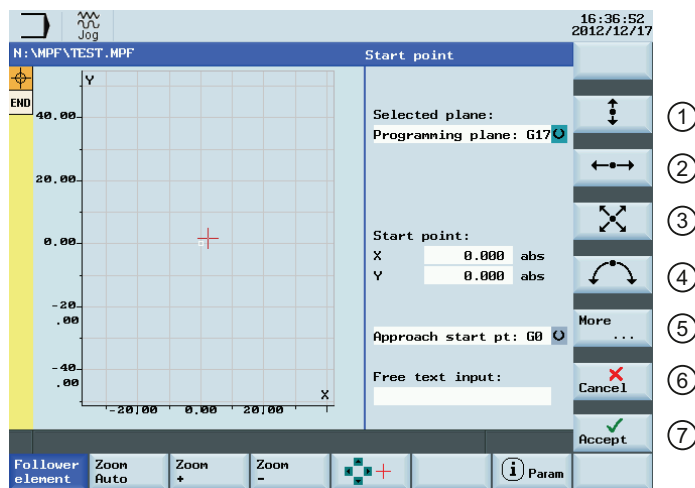

- ① Opens the window for programming a vertical straight line (in Z direction).
- ② Opens the window for programming a horizontal straight line (in Y direction).
- ③ Opens the window for programming an oblique line in the Y/Z direction. The end point of the line is entered using coordinates or an angle.
- ④ Opens the window for programming a circular arc with any direction of rotation.
- ⑤ Accesses more softkeys, for example:

Pole

Close contour
- ⑥ Returns to the program editor without transferring the last edited values to the system.
- ⑦ Returns to the program editor with the last edited values transferred to the system.

Further softkey functions

The following softkeys are available in corresponding contour element window for programming the contour elements on the basis of pre-assigned parameters.

Tangent to preceding element

Tangent.trans.

This softkey presets the angle α_2 to a value of 0. The contour element has a tangential transition to the preceding element, i.e. the angle to the preceding element (α_2) is set to 0 degree.



Display all parameters

All parameters

Press this softkey to display a selection list of all the parameters for the selected contour element. If you leave any parameter input fields blank, the control assumes that you do not know the right values and attempts to calculate these from the settings of the other parameters. The contour is always machined in the programmed direction.

Input switchover

Alternative

This softkey is displayed only in cases where the cursor is positioned on an input field with several switchover settings.

Select dialog

Dialog select

Some parameter configurations can produce several different contour characteristics. In such cases, you will be asked to select a dialog. By clicking this softkey, you can display the available selection options in the graphic display area.

Select this softkey to make the correct selection (green line). Confirm your choice with the following softkey:



Change a selected dialog

Change selection

If you want to change an existing dialog selection, you must select the contour element in which the dialog was originally chosen. Both alternatives are displayed again when you select this softkey.

Clear a parameter input field

Delete value

You can delete the value in the selected parameter input field with this softkey or the following key:



Save a contour element

Accept element

If you have entered the available data for a contour element or selected a desired dialog, pressing this softkey allows you to store the contour element and return to the main screen. You can then program the next contour element.

Append contour element

Use the cursor keys to select the element in front of the end marker.

Use the softkeys to select the contour element of your choice and enter the values you know in the input screen for that element.



Part programming

4.5 Free contour programming

Confirm your inputs with the following softkey:

Accept
element

Select contour element



Position the cursor on the desired contour element in the contour chain, and select it using this key.

The parameters for the selected element will then be displayed. The name of the element appears at the top of the parameterization window.

If the contour element can be represented geometrically, it is highlighted accordingly in the graphic display area, i.e. the color of the contour element changes from white to black.

Modifying contour element



You can use the cursor keys to select a programmed contour element in the contour chain. Press this key to display the parameter input fields. The parameters can now be edited.

Insert a contour element

Use the cursor keys in the contour chain to select the contour element in front of the position for the new element.

Then select the contour element to be inserted from the softkey bar.

After you have configured the parameters for the new contour element, confirm the insert operation by pressing the following softkey:

Accept
element

Subsequent contour elements are updated automatically according to the new contour status.

Delete contour element

Delete
element

Use the cursor keys to select the element you wish to delete. The selected contour symbol and associated contour element in the programming graphic are highlighted in red. Then press this softkey and confirm the query.

Close the contour

Close
contour

By pressing this softkey, you can close the contour from the actual position with a straight line to the starting point.

Undo an input

Cancel

By selecting this softkey you can return to the main screen **without** transferring the last edited values to the system.

Contour symbol colors

The meaning of the symbol colors in the contour chain on the left of the main screen is as follows:

Icon	Significance
Selected	Symbol color black on a red background -> Element is defined geometrically Symbol color black on a light yellow background -> Element is not defined geometrically
Not selected	Symbol color black on a gray background -> Element is defined geometrically Symbol color white on a gray background -> Element is not defined geometrically

4.5.4 Parameters for contour elements

Parameters for programming straight lines

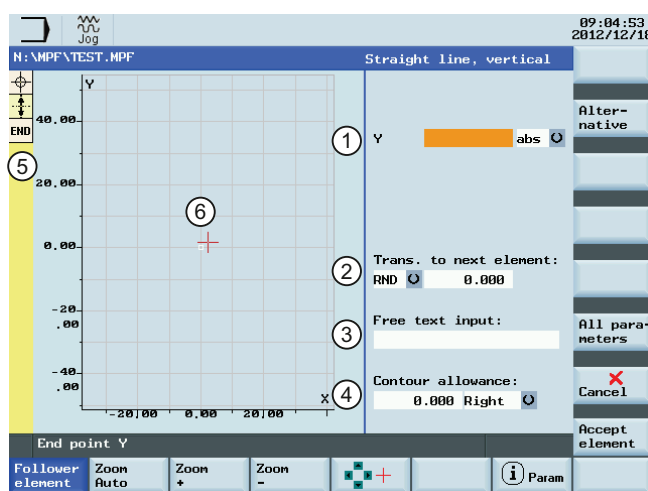

- ① Absolute (abs) / incremental (inc) end position in X or Y direction.
- ② Transition element to the next contour is a chamfer (CHR) or a radius (RND). CHR=0 or RND=0 means no transition element.
- ③ Input field for supplementary comments, such as F1000 feedrate values, H or M functions. If comments are entered as text, they must always be started with a semicolon ";".
- ④ You can specify a side-based parallel contour allowance. It is displayed as an allowance in the graphics window.
- ⑤ The contour chain which displays the start point and programmed contour elements. The current position in the chain is color-highlighted.
- ⑥ The graphics window which displays the progress of the contour as you configure the parameters for the contour elements.

Part programming

4.5 Free contour programming

All parameters

The following additional parameters are displayed after you press this softkey:

Parameter	Description
L	Length of the straight line
α_1	Pitch angle with reference to Y axis

Parameters for programming circular arcs

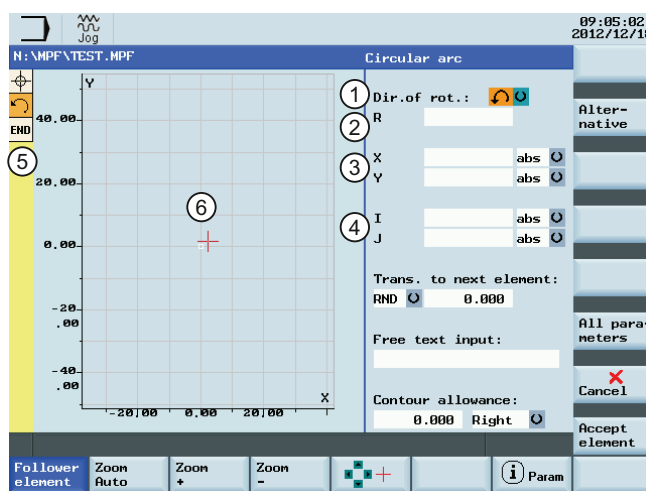

- | | |
|--|---|
| ① Direction of rotation of the circular arc: clockwise or counter-clockwise. | ④ Absolute (abs) / incremental (inc) positions of circle center point in Y (I) and X (K) directions. |
| ② Radius of circle. | ⑤ The contour chain which displays the start point and programmed contour elements. The current position in the chain is color-highlighted. |
| ③ Absolute (abs) / incremental (inc) end positions in X and Y directions. | ⑥ The graphics window which displays the progress of the contour as you configure the parameters for the contour elements. |

All parameters

The following additional parameters are displayed after you press this softkey:

Parameter	Description
α_1	Starting angle with reference to Y axis
α_2	Angle to preceding element; tangential transition: $\alpha_2=0$
β_1	End angle with reference to Y axis
β_2	Angle of aperture of circle

Machine manufacturer

The names of the identifiers (X or Y ...) are defined in the machine data where they can also be changed.



Transition to next element

A transition element can be used whenever there is a point of intersection between two neighboring elements; this can be calculated from the input values.

You can choose to insert either a radius (RND), a chamfer (CHR) or an undercut as the transition element between any two contour elements. The transition is always appended to the end of a contour element. You select transition elements in the parameter input screen for the relevant contour element.

Radius or chamfer at the start or the end of a turning contour:

In simple turning contours a chamfer or radius must often be appended at the start and end of the contour.

A chamfer or radius terminates an axis-parallel contour section on the blank:

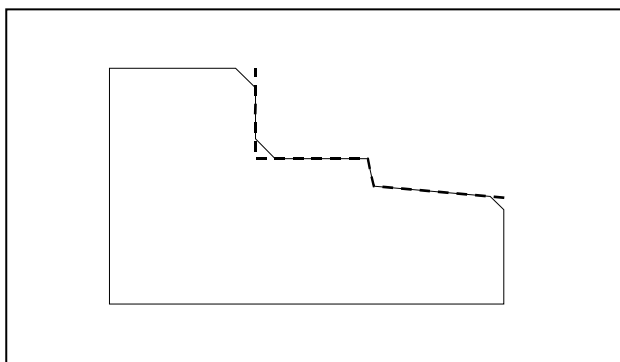

Figure 4-3 Contour with radius or chamfer

You select the direction of transition for the contour start in the starting point screen. You can choose between chamfer and radius. The value is defined in the same manner as for the transition elements.

In addition, four directions can be selected in a single selection field. You select the direction of the transition element for the contour end in the end screen. This selection is always proposed, even if preceding elements were assigned no transition.

Contour chain

Once you complete or cancel the programming of a contour element, you can navigate around the contour chain (left on the main screen) using the cursor keys. The current position in the chain is color-highlighted.

The elements of the contour and pole, if applicable, are displayed in the sequence in which they were programmed.

You can select an existing contour element with the following key and reassign its parameters:



Part programming

4.5 Free contour programming

A new contour element is inserted after the cursor when you select one of the contour elements on the vertical softkey bar; the input focus is then switched to the parameter input on the right of the graphic display. Programming always continues after the element selected in the contour chain.

You can delete the selected element from the chain by selecting the following softkey:

Delete
element

Graphics window

The graphics window displays the progress of the contour chain as you configure the parameters for the contour elements. The element you have selected is displayed in black in the graphics window.

The contour is displayed to the extent it can be interpreted by the control on the basis of parameter inputs. If the contour is still not displayed in the programming graphic, further values must be entered. Check the contour elements you have already programmed, if required. You may have forgotten to enter all of the known data.

The coordinate system scaling is automatically adapted to changes in the complete contour.

The position of the coordinate system is displayed in the graphics window.

An element was selected using the cursor keys.

Pressing the following softkey allows you to enlarge the image section of the selected element:

Follower
element



4.5.5 Specifying contour elements in polar coordinates

Functionality

The description about defining the coordinates of contour elements applies to the specification of positional data in the Cartesian coordinate system. Alternatively, you have the option to define positions using polar coordinates.

When programming contours, you can define a pole at any time prior to using polar coordinates for the first time. Programmed polar coordinates subsequently refer to this pole. The pole is modal and can be re-defined at any time. It is always entered in absolute Cartesian coordinates. The contour calculator converts values entered as polar coordinates into Cartesian coordinates. Positions can be programmed in polar coordinates only **after** a pole has been specified. The pole input does not generate a code for the NC program.

Pole

The polar coordinates are valid in the level selected with G17 to G19.



The pole is a contour element that can be edited, which itself does not contribute to the contour. It can be entered when the starting point of the contour is defined or anywhere within the contour. The pole cannot be created before the starting point of the contour.



This softkey allows you to specify a pole and can only be entered in absolute Cartesian coordinates. This softkey is also present in the starting point screen. This enables the pole to be entered at the start of a contour, so that the first contour element can be entered in polar coordinates.

Further notes

If the straight line that was generated with close contour is linked to the start element of the contour with a radius or chamfer, the radius or chamfer must be specified explicitly as follows:

- Close contour, input key, enter radius/chamfer, accept element. The result then corresponds exactly to what would occur if the closing element were to be entered with the radius or chamfer.

Close contour can only be used for entering contour elements in **polar coordinates** if the starting point of the contour was set to polar and the **same pole** is still valid when the contour is closed.

Input switchover: Cartesian/polar

The following contour elements can be entered optionally in polar coordinates only after a pole has been defined, whether this was done at the outset or later in the process:

- Circular arcs,
- Straight lines (horizontal, vertical, any direction)

To switchover between Cartesian and polar coordinates, additional toggle fields are displayed in the programming windows for the contour elements of oblique lines and circular arcs.

Part programming

4.5 Free contour programming

A toggle field is not displayed if no pole exists. Input fields and display fields are then only available for Cartesian values.

Absolute/incremental input

Absolute and incremental polar coordinates can be input for "polar/Cartesian". The input fields and display fields are labeled **inc** and **abs**.

Absolute polar coordinates are defined by an absolute distance to the pole that is always positive and an angle in the range of $0^\circ \dots \pm 360^\circ$. When absolute dimensions are specified, the angular reference is based on a horizontal axis of the working plane, e.g. X axis with G17. The positive direction of rotation runs counter-clockwise.

If there are several input poles, the definitive pole is always the **last pole** before the input or edited element.

Incremental polar coordinates relate to both the definitive pole and the end point of the preceding element.

For an incremental input, **the absolute distance** to the pole is calculated using the absolute distance from the end point of the preceding element to the pole plus the length increment that was entered.

The increment can be positive or negative.

The absolute angle is calculated accordingly using the absolute polar angle of the preceding element plus the angular increment. It is not necessary here for the preceding element to have been entered as polar.

In contour programming, the contour calculator converts the Cartesian coordinates of the preceding end point using the definitive pole into polar coordinates. This also applies if the preceding element has been given in polar coordinates, since this could relate to another pole if a pole has been inserted in the meantime.

Pole change example

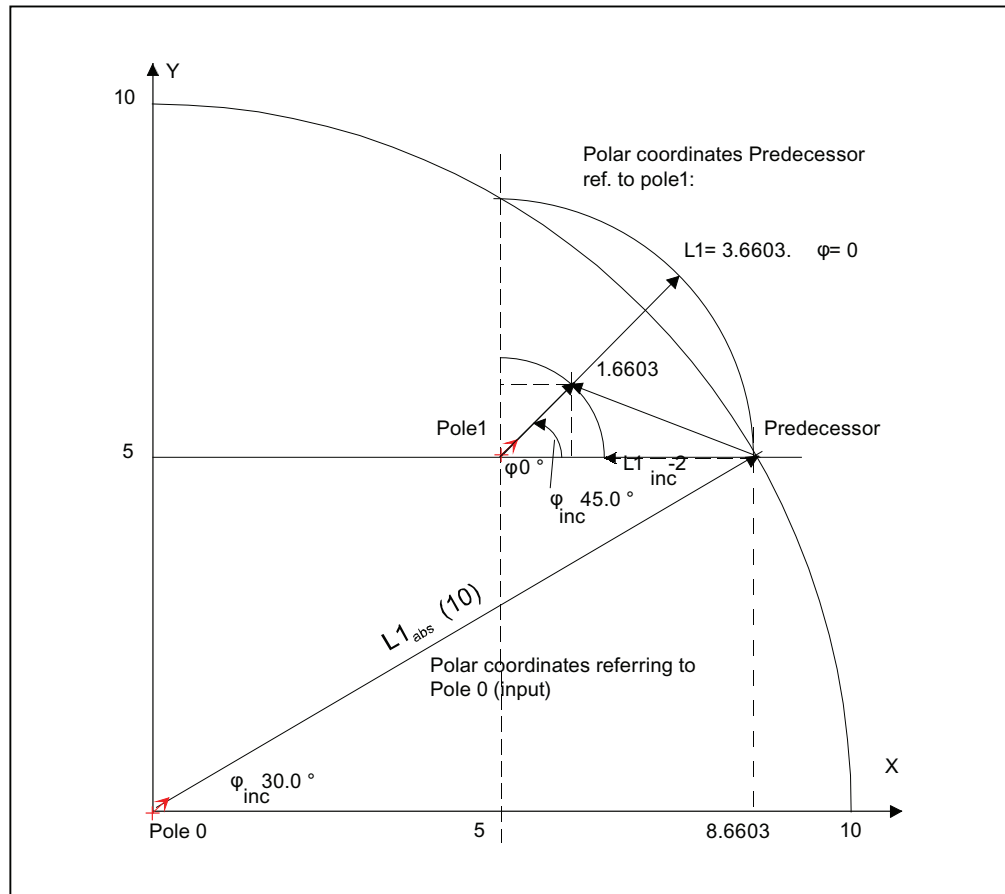

Figure 4-4 pole change (milling)

Pole: Xpole = 0.0, Ypole = 0.0, (Pole 0)

End point:

L1abs = 10.0 φabs = 30.0°
Calculated Cart. Coordinates
Xabs = 8.6603 Yabs = 5.0

New pole:

Xpole1 = 5.0 Ypole1 = 5.0 (Pole 1)

Calculated polar coord. Predecessor

L1abs = 3.6603 φabs = 0.0°

Next point:

L1inc = -2.0 φinc = 45.0°

Absolute polar coordinates for current element

L1abs = 1.6603 φabs = 45.0°

Calculate Cartesian coordinates

Xabs = 1.1740 Yabs = 1.1740

4.5.6 Cycle support

Functionality

The technologies below are provided with the additional support in the form of pre-defined cycles, which then must be parameterized.

- Drilling
- Milling

For more information, refer to the Programming and Operating Manual (Milling) Part 2.

4.5.7 Programming example for milling

Example 1

The following diagram shows a programming example for the "Free contour programming" function.

Starting point: X=5.67 abs., Y=0 abs., machining plane G17

The contour is programmed in a counter-clockwise direction.

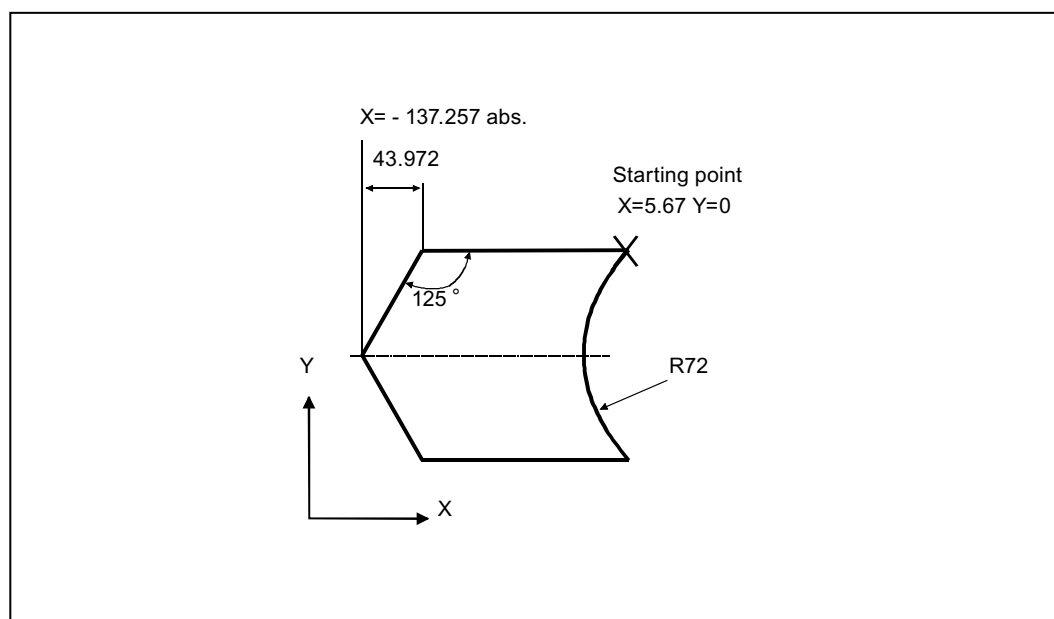

Figure 4-5 Workshop drawing of the contour, example 1



Operating sequence:



1. Select the desired operating area.



2. Enter the desired program folder.

3. Select a program with cursor keys and press this key to open the program in the program editor.



4. Press this softkey to open the contour editor.



5. Define a start point with the following parameters and press this softkey to confirm.

- Programming plane: G17
- X: 5.67 abs.
- Y: 0



6. Press this softkey to select a contour element of straight horizontal line.

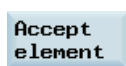

7. Enter the parameters for this element and press this softkey to confirm.

- X: -93.285 abs.



8. Press this softkey to select a contour element of straight line in any direction.



9. Enter the parameters for this element and press this softkey to confirm.

- X: -43.972 inc.
- $\alpha 1: -125^\circ$



10. Press this softkey to select a contour element of straight line in any direction.



11. Enter the parameters for this element and press this softkey to confirm.

- X: 43.972 inc.
- $\alpha 1: -55^\circ$



12. Press this softkey to select a contour element of straight horizontal line.



13. Enter the parameters for this element and press this softkey to confirm.

- X: 5.67 abs.



14. Press this softkey to select a contour element of circular arc.

Part programming

4.5 Free contour programming

**Dialog
select**

15. Enter the parameters for this element and press this softkey to select the desired contour characteristics.

- Direction of rotation: clockwise
- R: 72
- X: 5.67 abs.
- Y: 0 abs.

**Accept
element**

16. Press this softkey to confirm.

Now you can see the programmed contour in the graphics window:

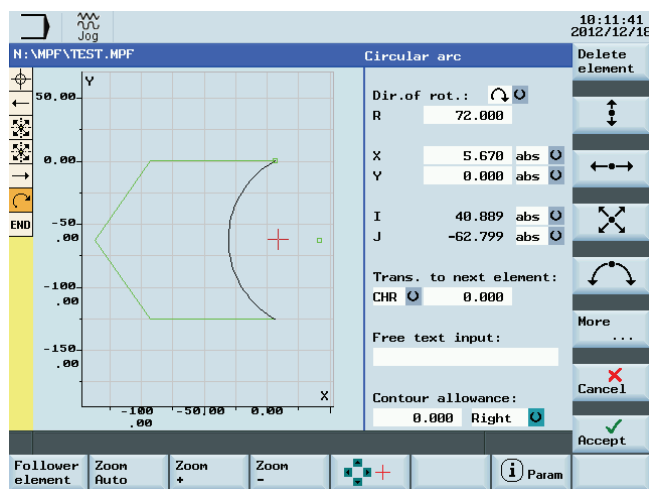



Example 2

Starting point: X=0 abs., Y=0 abs., machining plane G17

The contour is programmed in the clockwise direction with dialog selection.

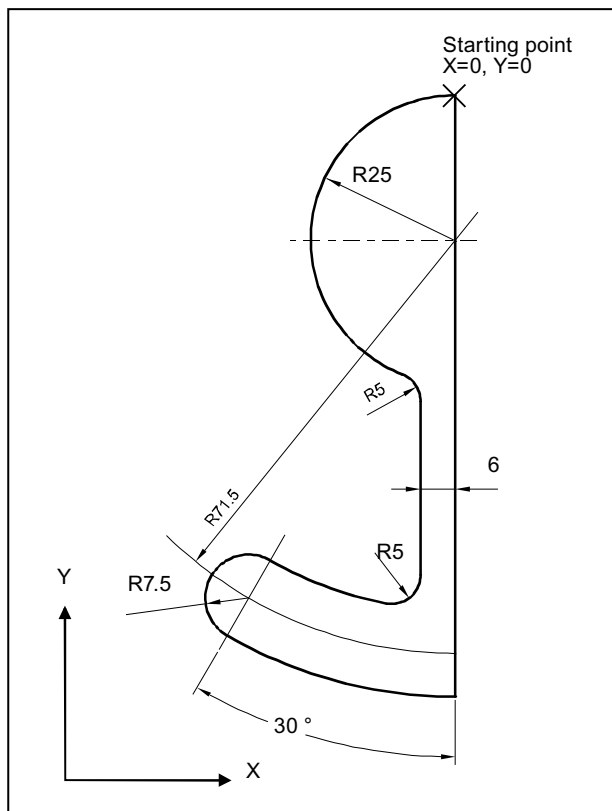

Figure 4-6 Workshop drawing of the contour, example 2

Operating sequence:



1. Select the desired operating area.



2. Enter the desired program folder.

3. Select a program with cursor keys and press this key to open the program in the program editor.



4. Press this softkey to open the contour editor.



5. Define a start point with the following parameters and press this softkey to confirm.

- Programming plane: G17
- X: 0
- Y: 0

Part programming

4.5 Free contour programming



6. Press this softkey to select a contour element of straight vertical line.



7. Enter the parameters for this element and press this softkey to confirm.

- Y: -104 abs.



8. Press this softkey to select a contour element of circular arc.

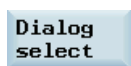

9. Enter the parameters for this element and press this softkey to select the desired contour characteristics.

- Direction of rotation: clockwise
- R: 79
- I: 0 abs.
- $\beta 2$: 30 °



10. Press this softkey to confirm.



11. Press this softkey to select a contour element of circular arc.



12. Enter the parameters for this element and press this softkey to select the desired contour characteristics.

- Direction of rotation: clockwise
- R: 7.5
- $\beta 2$: 180 °



13. Press this softkey to confirm.



14. Press this softkey to select a contour element of circular arc.

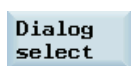

15. Enter the parameters for this element and press this softkey to select the desired contour characteristics.

- Direction of rotation: counter-clockwise
- R: 64
- X: -6 abs.
- I: 0 abs.
- RND: 5



16. Press this softkey to confirm.



17. Press this softkey to select a contour element of straight vertical line.



18. Enter the parameters for this element and press this softkey to confirm.

- $\alpha 1$: 90 °
- RND: 5



19. Press this softkey to select a contour element of circular arc.



20. Enter the parameters for this element and press this softkey to select the desired contour characteristics.

- Direction of rotation: clockwise
- R: 25
- X: 0 abs.
- Y: 0 abs.
- I: 0 abs.



21. Press this softkey to confirm.

Now you can see the programmed contour in the graphics window:

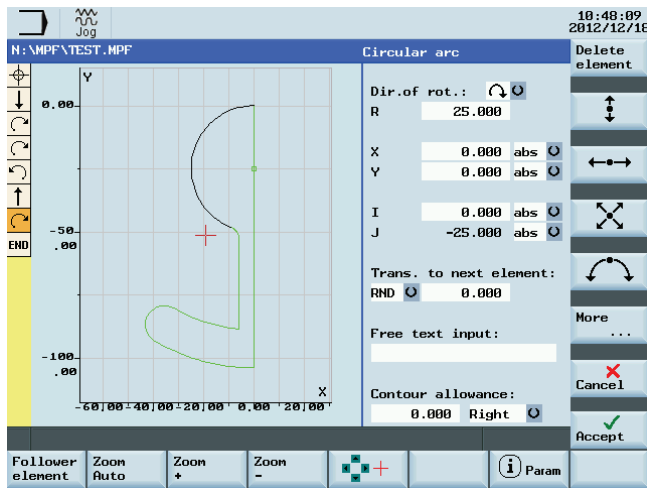

Part programming

4.5 Free contour programming

Example 3

Starting point: X=0 abs., Y=5.7 abs., machining plane G17

The contour is programmed in a clockwise direction.

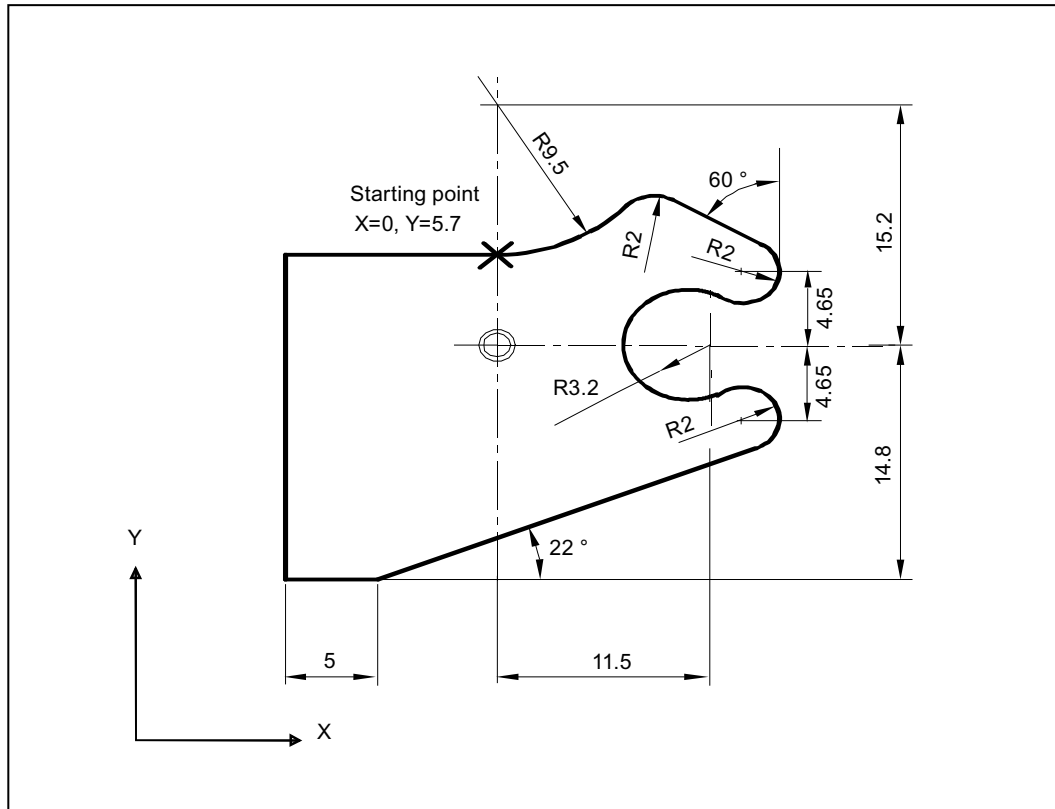

Figure 4-7 Workshop drawing of the contour, example 3

Operating sequence:



1. Select the desired operating area.



2. Enter the desired program folder.

3. Select a program with cursor keys and press this key to open the program in the program editor.



4. Press this softkey to open the contour editor.



5. Define a start point with the following parameters and press this softkey to confirm.

- Programming plane: G17
- X: 0 abs.
- Y: 5.7 abs.



6. Press this softkey to select a contour element of circular arc.

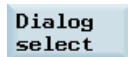

7. Enter the parameters for this element and press this softkey to select the desired contour characteristics.

- Direction of rotation: counter-clockwise
- R: 9.5
- I: 0 abs.
- RND: 2



8. Press this softkey to confirm.



9. Press this softkey to select a contour element of straight line in any direction.



10. Enter the parameters for this element and press this softkey to confirm.

- α_1 : -30°



11. Press this softkey to select a contour element of circular arc.



12. Enter the parameters for this element and press this softkey to select the desired contour characteristics.

- Direction of rotation: clockwise
- R: 2
- J: 4.65 abs.

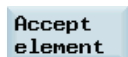

13. Press this softkey to confirm.



14. Press this softkey to select a contour element of circular arc.



15. Enter the parameters for this element and press this softkey to select the desired contour characteristics.

- Direction of rotation: counter-clockwise
- R: 3.2
- I: 11.5 abs.
- J: 0 abs.

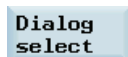

16. Press this softkey to confirm.



17. Press this softkey to select a contour element of circular arc.



18. Enter the parameters for this element and press this softkey to select the desired contour characteristics.

- Direction of rotation: clockwise
- R: 2
- J: -4.65 abs.

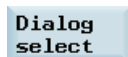

Part programming

4.5 Free contour programming



19. Press this softkey to confirm.



20. Press this softkey to select a contour element of straight line in any direction.



21. Enter the parameters for this element and press this softkey to select the desired contour characteristics.

- $\alpha 1: -158^\circ$
- Y: -14.8 abs.
- $\alpha 2: 0^\circ$



22. Press this softkey to confirm.



23. Press this softkey to select a contour element of straight horizontal line.

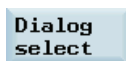

24. Enter the parameters for this element and press this softkey to select the desired contour characteristics.

- L: 5



25. Press this softkey to confirm.



26. Press this softkey to select a contour element of straight vertical line.



27. Enter the parameters for this element and press this softkey to confirm.

- Y: 5.7 abs.



28. Press this softkey to select a contour element of straight horizontal line.



29. Enter the parameters for this element and press this softkey to confirm.

- X: 0 abs.

Now you can see the programmed contour in the graphics window:

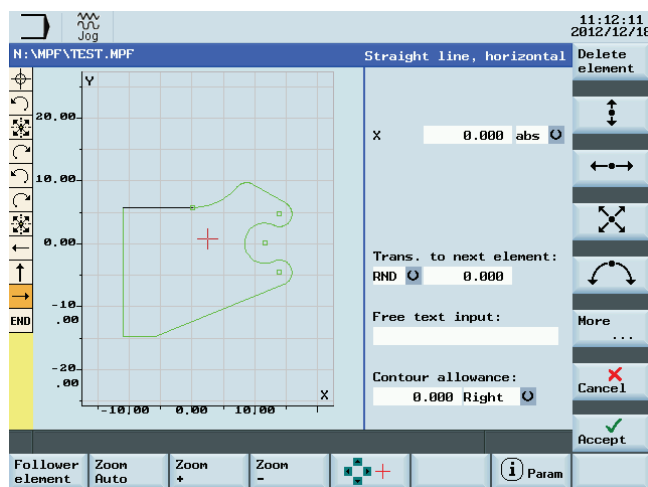

5

Automatic machining

Overview

The machine must have been set up for "AUTO" mode according to the specifications of the machine manufacturer. You can perform such operations as program start, stop, control, block search, and real-time simulation, etc.

Softkey functions

Pressing  key on the PPU and then  key on the MCP allows you to open the following window:

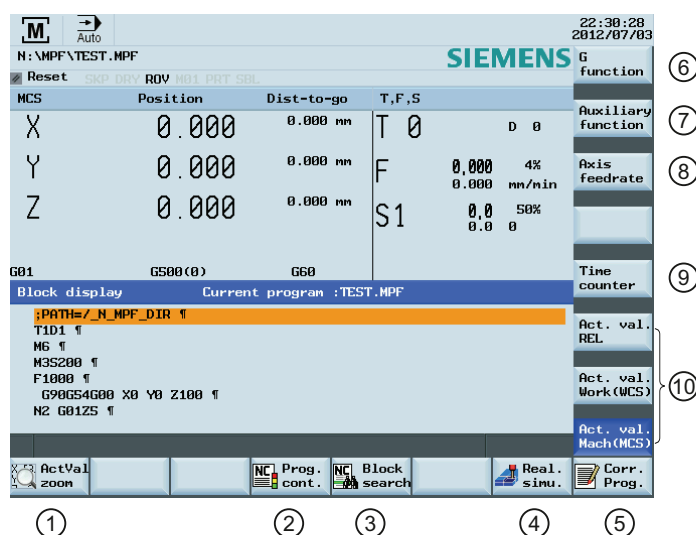

- ① Zooms in the actual value window
- ② Performs the program test, dry run, conditional stop, block skipping
- ③ Finds the desired block location
- ④ Activates the simulation function
- ⑤ Corrects a wrong program block. Any changes will be stored immediately.
- ⑥ Displays important G functions
- ⑦ Displays currently active auxiliary and M functions
- ⑧ Displays the axis feedrate in the selected coordinate system
- ⑨ Displays the information of part machining time (part timer) and part counter
- ⑩ Switches over the coordinate system in the actual value window

Automatic machining

5.1 Performing the simulation

Parameters

MCS	Position	Dist-to-go
X	0.000	0.000 mm
Y	0.000	0.000 mm
Z	0.000	0.000 mm
①	②	③
G01	G500(0)	G60
Block display		Current program : TE
;PATH=/_N_MPF_DIR ¶		
T1D1 ¶		
M6 ¶		
M3S200 ¶		
F1000 ¶		
G90G54G00 X0 Y0 Z100 ¶		
N2 G01Z5 ¶		

①	Displays the axes that exist in the machine coordinate system (MCS), workpiece coordinate system (WCS), or relative coordinate system (REL).	③	Displays the remaining distance for the axes to traverse.
②	Displays the current position of the axes in the selected coordinate system.	④	Displays seven subsequent blocks of the currently active part program. The display of one block is limited to the width of the window.

5.1 Performing the simulation

Functionality

By using the broken-line graphics, the programmed tool path can be traced. Before the automatic machining, you need to perform the simulation to check whether the tool moves in the right way.

Operating sequence



1. Select the desired operating area.



2. Move the cursor to select a part program for simulation.

3. Press this key to open the program.



4. Switch to "AUTO" mode.



- Press this softkey to open the program simulation window, and the program control mode PRT is automatically activated.
If the control system is not in the correct operating mode, a message appears at the bottom of the screen as follows. If this message appears, repeat Step 4.

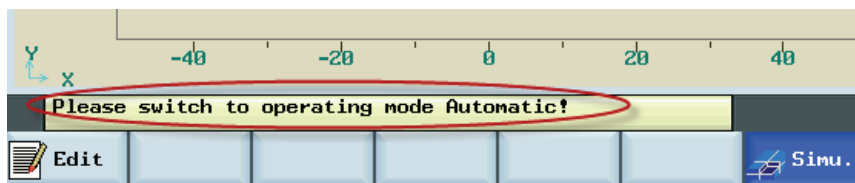

- Press this key to start the standard simulation for the execution of the selected part program. Note that the simulation function can be executed only when the control system is in the "AUTO" operating mode!

Softkey functions

The following describes the functions of the softkeys on the simulation main screen.

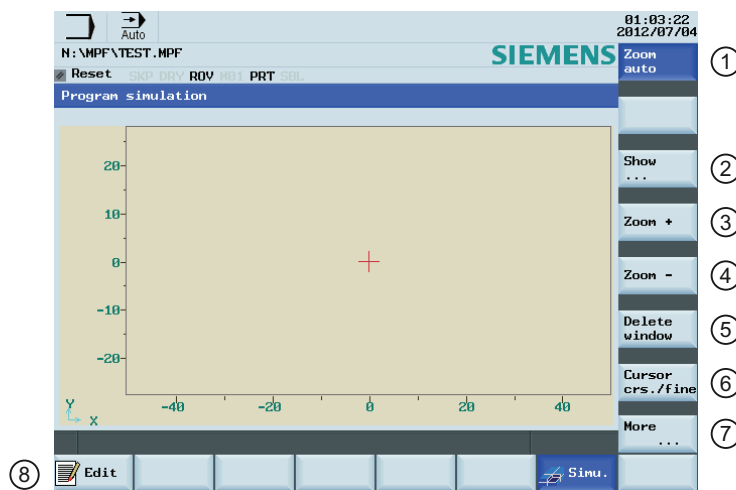

- Shows the simulation track automatically.
- Enters the lower-level menu for block displaying. Three displaying options are available:

All G17 blocks	All G18 blocks	All G19 blocks
----------------	----------------	----------------
- Zooms in the whole screen.
- Zooms out the whole screen.
- Deletes the current simulation track.
- Makes the cross hair move in large or small steps with the cursor.
- Shows more options:

Material removal	Enables the material removal simulation of a defined blank
Show blocks	Selects whether to show the blocks or not
- Returns to the program editor window.

5.2 Program control

Operating sequence



1. Select the desired operating area.







2. Switch to "AUTO" mode.



3. Press this softkey to open the lower-level menu for program control.

4. Press the corresponding vertical softkey to activate or deactivate the desired program control option (see table below for detailed softkey functions). The softkeys selected are highlighted in blue.

Softkey functions

Program test	<p>Disables the output of setpoints to axes and spindles. The setpoint display "simulates" the traverse movements.</p> <p>It functions the same as pressing the following key:</p>  <p>For more information of the program test, refer to Section "Program test (Page 91)".</p>
Dry run feedrate	<p>All traversing motions are performed with the feedrate setpoint specified via the "Dry run feed" setting data. Instead of the programmed motion commands, the dry run feed rate is effective.</p>
Condit. stop	<p>Stops processing of the program at every block in which miscellaneous function M01 is programmed.</p> <p>It functions the same as pressing the following key:</p> 
Skip	<p>Skips program blocks that are identified with a slash in front of the block number (e.g. "/N100").</p>
SBL fine	<p>Available only in the following state:</p>  <p>Each block is decoded separately, and a stop is performed at each block. However, for the thread blocks without dry run feedrate, a stop is only performed at the end of the current thread block.</p> <p>It functions the same as pressing the following key:</p> 



ROV active	<p>The feedrate override switch also acts on the rapid traverse override. It functions the same as pressing the following key:</p> <div style="text-align: center; margin-top: 10px;">  </div>
----------------------	---

Note: After pressing the above softkeys or keys, the corresponding icons appear immediately in the program status bar and the selected softkeys are highlighted in blue.

5.3 Program test

You need to test a part program with dry run before machining pieces. Before executing the dry run, first remove the workpiece from the machine.

Operating sequence



1. Select the desired operating area.



2. Switch to "AUTO" mode.



3. Press this softkey to open the lower-level menu for program control.



4. Press this vertical softkey to activate the feedrate settings for the dry run (for the specific settings of the dry run feedrate, refer to Section "Entering / modifying the setting data (Page 44)").



5. Press this key on the MCP to close the door in the machine (if you do not use this function, just close the door in the machine manually).



6. Make sure the feedrate override is 0%. Check that correct tool is in spindle before continuing.

7. Press this key on the MCP to run the program.



8. Turn the feedrate override switch to the desired value.

9. Press this key to stop the program test.

Automatic machining

5.4 Starting and stopping / interrupting a part program

5.4 Starting and stopping / interrupting a part program

Starting a part program

Before starting a program, make sure that both the control system and the machine are set up. Observe the relevant safety notes of the machine manufacturer.

Operating sequence



1. Select the desired operating area.



2. Press a softkey to go to the desired directory.



3. Place the cursor bar on the desired program and press this softkey. For some directories, press the following softkey instead:

Ext. execution

The system automatically changes to "AUTO" mode in the machining operating area after the key press.



4. If desired, you can use this softkey to specify how you want the program to be executed (for more information of the program control, refer to Section "Program control (Page 90)").



5. Press this key to start the automatic machining of the program.

Stopping / interrupting a part program



Press this key to stop the execution of a part program. The program currently running is aborted. On the next program start, the machining starts from the beginning.



Press this key to interrupt the execution of a part program. The axes stop running while the spindle continues running. On the next program start, the machining is resumed from the interruption point.



5.5 Executing / reading in a part program from external

Communication tool - SinuComPCIN

To enable the RS232 communication between a SINUMERIK 808D and a PC/PG, you must have the RS32 communication tool SinuComPCIN installed on your PC/PG. This tool is available in the SINUMERIK 808D Toolbox.

RS232 Communication settings

Proceed as follows to configure the communication settings for the RS232 interface:

1. Connect the control system with the PC/PG using an RS232 cable.
2. Select the desired operating area on the PPU.
3. Press this softkey to go to the RS232 directory.
4. Press this softkey to open the window for RS232 communication settings.
5. Use this key to set the values in the following window as required:



Communications settings	
Device	RTS CTS
Baud rate	19200
Stop bits	1
Parity	None
Data bits	8
End of transmis.	1a
Confirm overwrite	N



6. Press this softkey to save your settings. If desired, you can press the following softkey to reset the settings to defaults:

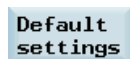

7. Return to the RS232 main screen.

8. Open the SinuComPCIN on your PC/PG.

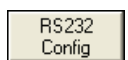

9. Press this button on the main screen and then select the desired baudrate from the list. Note that this baudrate must be the same as that you have selected on the NC side.

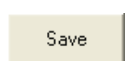

10. Save the settings with this button.

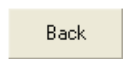

11. Return to the main screen of SinuComPCIN.

Automatic machining

5.5 Executing / reading in a part program from external

Executing a part program from external

Proceed as follows to execute a part program from external via the RS232 interface:



1. Select the desired operating area on the PPU.



2. Press this softkey to go to the RS232 directory.

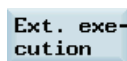

3. Press this vertical softkey, and the system automatically changes to "AUTO" mode in the machining operating area.



4. Press this button on the main screen of SinuComPCIN and select the desired program for execution, for example, Test.mpf. The program is transferred to the buffer memory on the control system and then displayed in the following window:

```

Block display          Current program :TEST.MPF
;PATH=/_N_MPF_DIR ¶
T1D1 ¶
M6 ¶
M3S200 ¶
F1000 ¶
G90G54G00 X0 Y0 Z100 ¶
N2 G01Z5 ¶
  
```



5. If desired, you can use this softkey to specify how you want the program to be executed (for more information of the program control, refer to Section "Program control (Page 90)").



6. Press this key to execute the program. The program is reloaded continuously.

Either at the end of the program or after pressing the following key, the program is automatically removed from the control system:



Note

When using the external execution via RS232, the RS232 interface must not be active for another application. This means, for example, the RS232 interface must not be active through the following operation:



> "PLC" > **STEP 7 connect** .

Reading in a part program from external

Note

The program files can be transferred only to the system drive N:\MPF or N:\CMA; therefore, before transfer, make sure the drive identifier contained in the first line in the program file is "N" and the target directory in the second line is "N_MPF" or "N_CMA". If not, you must change manually, for example:

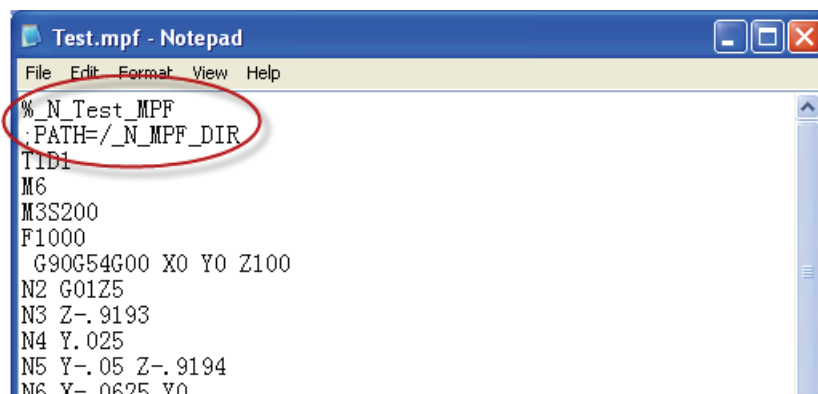

```

Test.mpf - Notepad
File Edit Format View Help
% N_Test_MPF
; PATH=/_N_MPF_DIR
T1D1
M6
M3S200
F1000
G90G54G00 X0 Y0 Z100
N2 G01Z5
N3 Z-.9193
N4 Y.025
N5 Y-.05 Z-.9194
N6 X-.0625 Y0
    
```

Proceed as follows to transfer a part program:



1. Select the desired operating area on the PPU.



2. Press this softkey to go to the RS232 directory.



3. Press this vertical softkey in the RS232 window.



4. Press this button on the main screen of SinuComPCIN and select the desired program for execution, for example, Test.mpf. The data transferring starts.

On the NC side:



On the SinuComPCIN side:



5. Wait until SinuComPCIN has finished data transfer, and click this button.

5.6 Machining at a specific point

Functionality

The block search function provides advance of the program to the required block in the part program. You can start machining from a specified program block after stopping / interrupting the program execution or during remachining.

Operating sequence



1. Select the desired operating area.



2. Switch to "AUTO" mode.



3. Press this softkey to open the block search window.



4. Search for the required starting point with cursor keys or the following softkey:



Search

If the part program is stopped / interrupted in the last machining operation, you can press the following softkey to load the interruption point as required:

**Interr.
point**

5. Press one of the following softkeys to set the condition for the block search:

**To
contour**

After the block search, the program will continue from the line before the interruption point. The same calculations of the basic conditions (for example: tool and cutting edge numbers, M functions, feedrate and spindle speed) are carried out as during normal program operation, but the axes do not move.

**To
end point**

After the block search, the program will continue from the line with the interruption point. The same calculations of the basic conditions are carried out as during normal program operation, but the axes do not move.

**Without
calculat.**

Block search without calculation of the basic conditions.

6. Make sure the feedrate override is 0%. Check that correct tool is in spindle before continuing.



7. Press this key on the MCP, and then an alarm 010208 appears for your confirmation whether to continue.

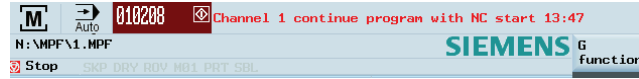

8. Press this key again to execute the program.
9. Turn the feedrate override switch on the MCP slowly to the desired value.



Automatic machining

5.6 Machining at a specific point

6

System

Softkey functions

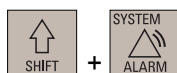

Pressing the above key combination allows you to open the following window. This operating area includes functions required for parameterizing and analyzing the NCK, the PLC and the drive.

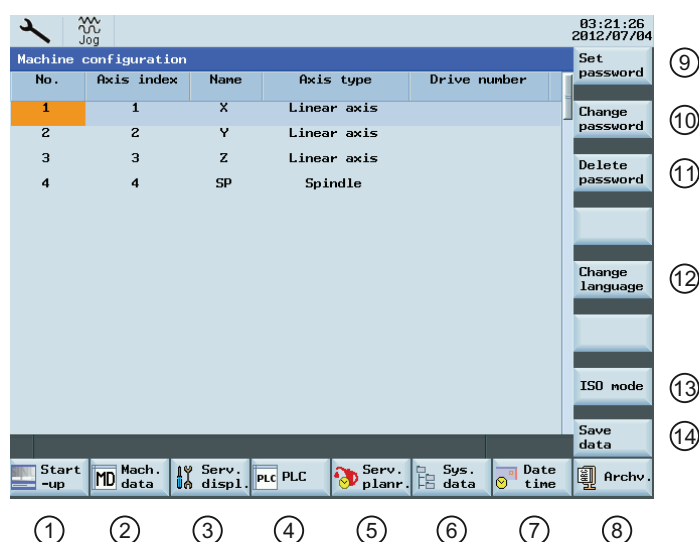

①	Sets the NC, PLC and HMI start up modes	⑧	Creates and restores startup archives, data archive
②	Sets the system machine data	⑨	Enters the corresponding password (system password, manufacturer password, and end user password) to access the different user levels
③	Views the service information	⑩	Changes the password as per the corresponding access levels
④	Provides PLC commissioning and diagnostics	⑪	Deletes the current password
⑤	Defines the maintenance planner	⑫	Selects the user interface language. Note that the HMI is automatically restarted when a new language is selected.
⑥	Backs up and restores system data	⑬	Switches to the ISO programming mode
⑦	Sets the date and time shown on the screen	⑭	Saves the contents of the volatile memory into a non-volatile memory area

For more information about the softkey functions in this operating area, refer to the SINUMERIK 808D Diagnostics Manual.

Saving data

This function saves the NC and PLC data of the volatile memory into a non-volatile memory area.

Requirement:

There is no program currently executing.

Proceed through the following steps to save data:



1. Select the desired operating area.



2. Open the window for data saving.



3. Press this softkey to start saving. Do not carry out any operator actions while the data backup is running.

There are two methods to call the saved data.

Method 1:



1. Press this key while the control system is booting.

2. Select "Reload saved user data" in the setup menu.



3. Press this key to confirm.

Method 2:



1. Select the desired operating area.



2. Open the window for selecting the start up modes.



3. Press this softkey to open the following window, and use the cursor keys to select the third start up mode.

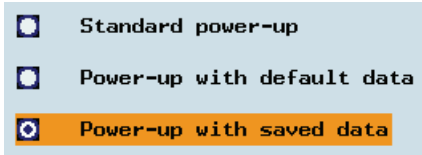

4. Press this softkey to confirm. The control system restarts with the saved data.

7

Data backup

Copying and pasting files

In the program management operating area, program files or directories can be copied into another directory or onto a different drive by means of copying and pasting operations.

Operating sequence



1. Select the desired operating area.



2. Enter the program directory.



3. Use this softkey or the cursor keys to select the program file or directory to be backed up.

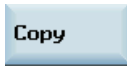

4. Press this softkey to copy the data to the clipboard.



5. Select a desired directory or drive as the data target.







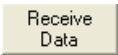

6. Press this softkey to paste the copied data into the current directory.

Backing up files via RS232 interface

The program files can be backed up onto an external PC/PG via the RS232 interface.

Operating sequence

1. Connect the control system with the PC/PG using an RS232 cable.
2. Configure the communication settings for the RS232 interface (see Section "Executing / reading in a part program from external (Page 93)").
- 
 3. Press this button on the main screen of SinuComPCIN and input the name for the text file, for example, Test.txt.
- 
 4. Select the desired operating area on the PPU.
- 
 5. Enter the program directory.
- 
 6. Select the program file to be backed up and press this softkey to copy it to the clipboard.
- 
 7. Enter the RS232 directory.
- 
 8. Press this vertical softkey in the RS232 window. The file transferring starts.
- 
 9. Wait until SinuComPCIN has finished data transfer, and click this button.

For more information, refer to the SINUMERIK 808D Diagnostics Manual.

A

Appendix

A.1 Pocket calculator



The calculator function can be activated from any other operating area using this key on the PPU (except in "MDA" mode).

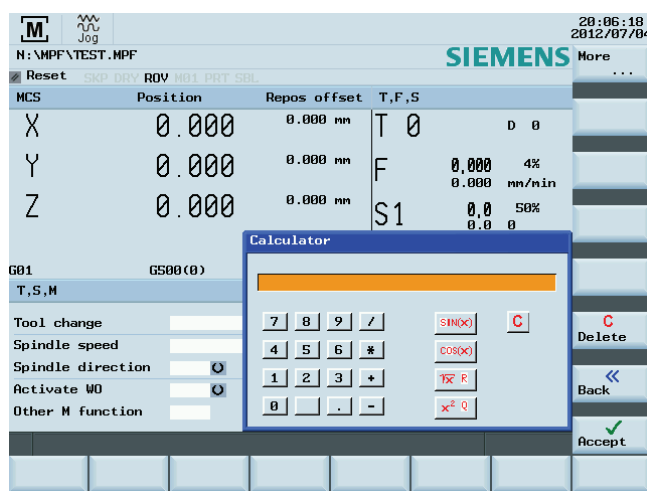

For calculating, the four basic arithmetic operations are available, as well as the functions "sine", "cosine", "squaring" and "square root". A bracket function is provided to calculate nested terms. The bracket depth is unlimited.

If the input field is already occupied by a value, the function will accept this value into the input line of the pocket calculator.

Pressing the following key starts the calculation. The result is displayed in the pocket calculator.



Selecting the following softkey enters the result in the input field at the current cursor position of the part program editor and closes the pocket calculator automatically.



Appendix

A.1 Pocket calculator

Characters that may be entered

+ , - , * , /	Basic arithmetic operations
S	Sine function The X value (in degrees) in front of the input cursor is replaced by the sin(X) value.
O	Cosine function The X value (in degrees) in front of the input cursor is replaced by the cos(X) value.
Q	Square root function The X value in front of the input cursor is replaced by the X ² value.
R	Square root function The X value in front of the input cursor is replaced by the \sqrt{X} value.
()	Bracket function (X+Y)*Z

Calculation examples

Task	Input -> Result
100 + (67*3)	100+67*3 -> 301
sin(45_)	45 S -> 0.707107
cos(45_)	45 O -> 0.707107
4 ²	4 Q -> 16
$\sqrt{4}$	4 R -> 2
(34+3*2)*10	(34+3*2)*10 -> 400

To calculate auxiliary points on a contour, the pocket calculator offers the following functions:

- Calculating the tangential transition between a circle sector and a straight line
- Moving a point in the plane
- Converting polar coordinates to Cartesian coordinates
- Adding the second end point of a straight line/straight line contour section given from an angular relation

A.2 Editing Chinese characters

The program editor and PLC alarm text editor both allow you to edit the simplified Chinese characters on the Chinese variant of the HMI.

Editing simplified Chinese characters

Press the **ALT** key and **> S** key to switch the editor on or off.

Press this key to toggle between different input methods.

Press the numeric keys (1 to 9) on the PPU to select the desired characters.

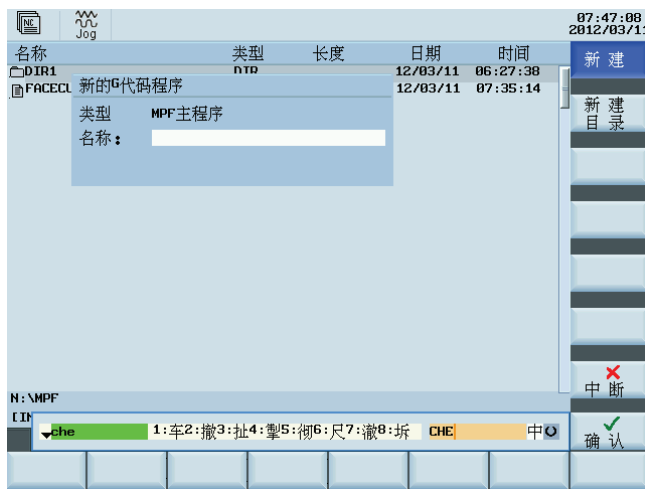

Figure A-1 Example of editing simplified Chinese

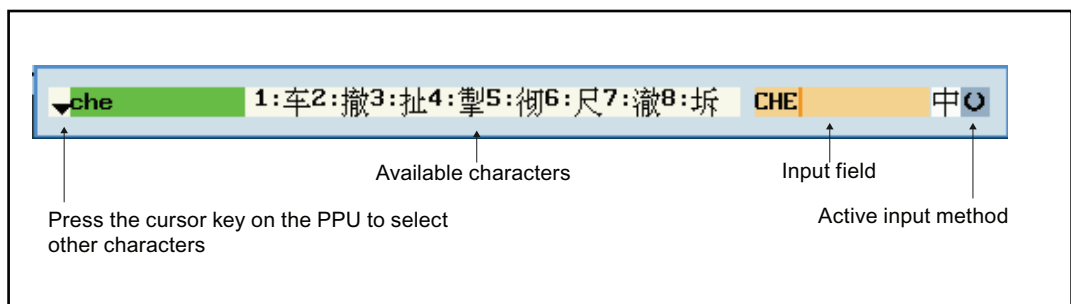

Figure A-2 Structure of editor



Appendix

A.2 Editing Chinese characters

Index

A

Absolute/incremental, 76
Arithmetic parameters, 47

C

Cartesian/polar, 75
Chamfer, 73
CHR, 73
Contour allowance, 71
Contour elements, 68
Contour transition element, 73
Coordinate systems
 Machine coordinate system (MCS), 13
 Relative coordinate system, 15
 Workpiece coordinate system (WCS), 14

F

Files
 Copy, 101
 Paste, 101
Free contour programming, 65

K

Key combinations, 9

M

Machine zero, 40
MCP, 10

P

Part program
 select, 92
Pole, 75
Pole change, 77
PPU, 7

R

Radius, 73
Recompile, 67
RND, 73

S

SINUMERIK 808D documentation set, 4
Starting point, 73

T

Tangent to preceding element, 68
Tool zero, 40

W

Work offset, 40



www.nicsanat.com

021-87700210